

**BEST TO READ PROCEEDINGS AS TWO-PAGE SPREAD IN ACROBAT**

In Acrobat, go to: View > Page Display > Two Page View



**PERFORMATIVE  
ENVIRONMENTS**

**ARCC  
CONFERENCE**

2021



Over 250 participants participated in ARCC 2021, with 66 double-blind, peer-review research papers, 23 research poster presentations, 3 keynotes, 2 plenary sessions, 1 seminar and 7 workshops, addressing the theme of Performative Environments.

Proceedings of the ARCC 2021 International Conference  
Architectural Research Centers Consortium  
Performative Environments

Editors: Chris Jarrett, Adil Sharag-Eldin  
Graphic Design (Proceedings): Chris Jarrett  
Publisher: Architectural Research Centers Consortium, Inc.

ISBN 978-1-935129-30-1

© 2021 Architectural Research Centers Consortium, Inc. All rights reserved. No part of this book may be reproduced in any manner whatsoever without prior written permission from the publisher.

# PERFORMATIVE ENVIRONMENTS

Technological  
Organizational  
Cultural

**Hosted by**  
ARCC 2021 International Conference  
University of Arizona, Tucson, AZ  
April 7-10, 2021

**Conference Co-Chairs**  
Clare Robinson  
Beth Weinstein

**Editors**  
Chris Jarrett  
Adil Sharag-Eldin



## TABLE OF CONTENTS

Conference Leadership and Administration	i
Past Conferences and ARCC Membership	ii
Conference Peer Review Committee <i>Two-Stage Double-Blind Peer Review</i>	iii-iv
Introduction by Conference Co-Chairs <i>Clare Robinson, Beth Weinstein</i>	v-vi
Keynote Speakers and Panelists <i>Eyal Weizman, Peggy Deamer, Michelle Addington Billie Faircloth, Jon McKenzie, Nicholas de Monchaux, Gray Read Mona El Khafif, Mae-Ling Lokko, Gray Read</i>	vii-xii
List of Research Papers and Posters	xiii-xxii
ARCC 2021 Research Papers	1-522
ARCC 2021 Research Poster Abstracts	523-534
Best Paper and Best Poster Awards <i>Iffat Ridwana, Mae-ling Lokko Margarita Ibarra Platt, Maria Guadalupe Alpuche Cruz</i>	

# **PERFORMATIVE ENVIRONMENTS**

**Proceedings of the ARCC 2021  
International Conference**



## **ARCC 2021 INTERNATIONAL CONFERENCE COMMITTEE**

### **Conference Co-Chairs**

Clare Robinson, University of Arizona  
Beth Weinstein, University of Arizona

### **Conference Advisory Committee**

Chris Jarrett, University of North Carolina at Charlotte  
Hazem Rashed-Ali, University of Texas at San Antonio  
Adil Sharag-Eldin, Kent State University

*Special Thanks to Philip Plowright for his consultation throughout the planning process.*

### **Session Moderators**

Rima Ajlouni, University of Utah  
Rahman Azari, Pennsylvania State University  
Jonathan Bean, University of Arizona  
Pravin Bhiwapurkar, University of Cincinnati  
Terri Boake, University of Waterloo  
Christina Bollo, University of Illinois at Urbana-Champaign  
Mike Christenson, University of Minnesota  
Courtney Crosson, University of Arizona  
Susannah Dickinson, University of Arizona  
Ihab Elzeyadi, University of Oregon  
Altaf Engineer, University of Arizona  
Saif Haq, Texas Tech University  
Laura Hollengreen, University of Arizona  
Ming Hu, University of Maryland  
Aletheia Ida, University of Arizona  
Kyounghee Kim, University of North Carolina at Charlotte  
Alison Kwok, University of Oregon  
Valerian Miranda, Texas A&M University  
Philip Plowright, Lawrence Technological University  
Hazem Rashed-Ali, University of Texas at San Antonio  
Traci Rider, North Carolina State University  
Clare Robinson, University of Arizona  
Fauzia Sadiq Garcia, Temple University  
Luis Santos, Kent State University  
Adil Sharag-Eldin, Kent State University  
Jennifer Shields, Cal Poly San Luis Obispo  
Brian Sinclair, University of Calgary  
Alexandra Staub, Pennsylvania State University  
Beth Weinstein, University of Arizona

### **ARCC BOARD OF DIRECTORS (2020-2021)**

#### **Officers**

Chris Jarrett, President, University of North Carolina at Charlotte  
Adil Sharag-Eldin, Vice-President/President-Elect, Kent State University  
Saif Haq, Treasurer, Texas Tech University  
Alexandra Staub, Secretary, Pennsylvania State University  
Hazem Rashed-Ali, Past-President, University of Texas at San Antonio

#### **At-Large Members**

Christina Bollo, University of Illinois at Urbana-Champaign  
Ihab Elzeyadi, University of Oregon  
Ming Hu, University of Maryland  
Clare Robinson, University of Arizona

#### **X-Officio Board Members**

Rahman Azari, Pennsylvania State University  
Valerian Miranda, Texas A&M University  
Philip Plowright, Lawrence Technological University  
Brian Sinclair, University of Calgary  
Michelle Russo, American Institute of Architects

**ARCC Past Conferences**

Paris\_2000 EAAE-ARCC International Conference  
Blacksburg\_2001 ARCC Conference  
Montreal\_2002 ARCC-EAAE International Conference  
Tempe\_2003 ARCC Conference  
Dublin\_2004 EAAE-ARCC International Conference  
Jackson\_2005 ARCC Conference  
Philadelphia\_2006 ARCC-EAAE International Conference  
Eugene\_2007 ARCC Conference  
Copenhagen\_2008 EAAE-ARCC International Conference  
San Antonio\_2009 ARCC Conference  
Washington DC\_2010 ARCC-EAAE International Conference  
Detroit\_2011 ARCC Conference

Milan\_2012 EAAE-ARCC International Conference  
Charlotte\_2013 ARCC Conference  
Honolulu\_2014 ARCC-EAAE International Conference  
Chicago\_2015 ARCC Conference  
Lisbon\_2016 EAAE-ARCC International Conference  
Salt Lake City\_2017 ARCC Conference  
Philadelphia\_2018 ARCC-EAAE International Conference  
Toronto\_2019 ARCC International Conference  
Valencia\_2020 EAAE-ARCC International Conference

**ARCC Member Institutions (2020-2021)**

American Institute of Architects  
Arizona State University  
Auburn University  
Ball State University  
Ball State University (CERES)  
California Baptist University  
California Polytechnic State University  
Catholic University of America  
Clemson University  
Drexel University  
Florida Atlantic University  
Florida A&M University  
Florida International University  
Georgia Institute of Technology  
Hampton University  
Howard University  
Illinois Institute of Technology  
Iowa State University  
Jefferson University  
Judson University  
Kansas State University  
Kennesaw State University  
Kent State University  
Laurentian University  
Lawrence Tech. University  
Lebanese American University  
Louisiana State University  
McGill University  
Miami University  
Mississippi State University  
Montana State University  
New Jersey Institute of Technology  
New York Institute of Technology  
North Carolina State University  
Northeastern University  
Norwich University  
Pennsylvania State University  
Portland State University  
Pratt Institute  
Rensselaer Polytechnic Institute  
Rochester Institute of Technology

Ryerson University  
South Dakota State University  
Stanford University  
Temple University  
Texas A&M University  
Texas Tech University  
Universitat Liechtenstein  
University of Arizona  
University of Arkansas  
University of Buffalo  
University of Calgary  
University of Florida  
University of Hawaii Manoa  
University of Houston  
University of Idaho  
University of Illinois UC  
University of Kansas  
University of Manitoba  
University of Maryland  
University of Memphis  
University of Michigan  
University of Minnesota  
University of Missouri  
University of Nebraska-Lincoln  
University of Nevada Las Vegas  
University of New Mexico  
University of North Carolina-Charlotte  
University of Oklahoma  
University of Oregon  
University of Southern California  
University of South Florida  
University of Tennessee  
University of Texas at Arlington  
University of Texas at San Antonio  
University of Toronto  
University of Utah  
University of Virginia  
University of Waterloo  
University of Wisconsin-Milwaukee  
Virginia Polytechnic University  
Washington State University

Individual Member  
Lubomir Popov



## Conference Peer Review Committee

**Adhya, Anirban**

Lawrence Technological University

**Agutter, James**

University of Utah

**Ajlouni, Rima**

University of Utah

**Akin, Naime Esra**

Aarhus School of Architecture, Denmark

**Aksamija, Ajla**

University of Massachusetts Amherst

**Ali, Ahmed K.**

Texas A&M University

**Anz, Craig**

Southern Illinois University

**Bachmann, Balint**

University of Pecs, Hungary

**Barber, Daniel**

University of Pennsylvania

**Bartosh, Amber Lynn Ebeling**

Syracuse University

**Baudoin, Genevieve**

Kansas State University

**Berardi, Umberto**

Ryerson University

**Bermudez, Julio**

The Catholic University of America

**Bhiwapurkar, Pravin**

University Of Cincinnati

**Boake, Terri**

University of Waterloo, Canada

**Bollo, Christina**

University of Illinois

**Brause, Caryn**

University of Massachusetts Amherst

**Brentrup, Dale**

University of North Carolina, Charlotte

**Bross, Benjamin A.**

University of Illinois Urbana-Champaign

**Caglar, Nur**

TOBB-University of Economics & Technology, Turkey

**Collins, Tom**

Ball State University

**Costanza, David**

University of North Carolina Charlotte

**De Walsche, Johan**

University of Antwerp, Belgium

**Del Bo, Adalberto**

Politecnico di Milano, Italy

**Demers, Matthew**

Barker Nestor Architects

**Diaz-Moore, Keith**

University of Utah

**Dincyurek, Ozgur**

Eastern Mediterranean University, Turkey

**Doyle, Shelby**

Iowa State University

**Elzeyadi, Ihab**

University of Oregon

**Emami, Niloufar**

Louisiana State University

**Engineer, Altaf**

University of Arizona

**Faoro, Daniel**

Lawrence Technological University

**Fonseca, Maria Teresa**

Universidade do Porto, Portugal

**Gámez, José L.S.**

University of North Carolina, Charlotte

**Garrison, Michael**

The University of Texas at Austin

**Golden, Saul M.**

Ulster University, United Kingdom

**Guzowski, Mary**

University of Minnesota

**Haar, Sharon**

University of Michigan

**Haglund, Bruce T**

University of Idaho

**Haq, Saif**

Texas Tech University

**Harrington, J. Brooke**

Temple University

**Harriss, Harriet**

Pratt Institute

**Hayes, Richard L.**

Central Michigan University

**Hennebury, Deirdre**

University of Michigan

**Hollengreen, Laura Holden**

University of Arizona

**Ida, Aletheia**

University of Arizona

**Ingaramo, Roberta**

Politecnico Di Torino, Italy

**Kim, Julie**

Georgia Institute of Technology

**Kim, Kyounghee**  
University of North Carolina Charlotte

**Ku, Kihong**  
Thomas Jefferson University

**Kwok, Alison**  
University of Oregon

**Lokko, Mae-ling**  
Rensselaer Polytechnic Institute

**Louro, Margarida**  
Universidade de Lisboa, Portugal

**Mansy, Khaled**  
Oklahoma State University

**Marks, Frederick**  
Salk Institute for Biological Studies

**Martinez-Molina, Antonio**  
The University of Texas at San Antonio

**Meek, Christopher**  
University of Washington

**Morgado, Sofia**  
Universidade de Lisboa, Portugal

**Mounayar, Michel**  
Ball State University

**Nanda, Upali**  
University of Michigan

**Nepomechie, Marilys R.**  
Florida International University

**Neveu, Marc**  
Arizona State University

**Ng, Tsz Yan**  
University of Michigan

**Noble, Douglas**  
University of Southern California

**Orlowski, Edward Michael**  
Lawrence Technological University

**Parente, Carlo**  
Ryerson University

**Passe, Ulrike**  
Iowa State University

**Plowright, Philip**  
Lawrence Technological University

**Poerschke, Ute**  
Penn State University

**Ragheb, Ash**  
Lawrence Technological University

**Rider, Traci**  
North Carolina State University

**Robinson, Julia Williams**  
University of Minnesota

**Rockwood, David**  
University of Hawaii at Manoa

**Rügemer, Jörg**  
University of Utah

**Santos, João Rafael**  
Universidade de Lisboa, Portugal

**Sarvimaki, Magi**  
Bond University, Australia

**Scheer, Brenda**  
University of Utah

**Schroepfer, Thomas**  
Singapore University of Technology and Design

**Schultz, Anne-Catrin**  
Wentworth Institute of Technology

**Schweder, Alex**  
Pratt Institute

**Senske, Nick**  
Iowa State University

**Sharag-Eldin, Adil**  
Kent State University

**Simon, Madlen**  
University of Maryland

**Sinclair, Brian**  
University of Calgary, Canada

**Staub, Alexandra**  
Penn State University

**Trova, Vaso**  
University of Thessaly, Greece

**Uihlein, Marci**  
University of Illinois Urban Champaign

**Van de Riet, Keith**  
University of Kansas

**Voorhees, Jeremy**  
Temple University

**Willoughby, William**  
Kent State University

**Wingert-Playdon, Kate**  
Temple University

**Zarzycki, Andrzej**  
New Jersey Institute of Technology

**Zhang, Catty Dan**  
University of North Carolina Charlotte



## **INTRODUCTION\_ARCC 2021 International Conference: Performative Environments**

Conference Co-Chairs: Clare Robinson and Beth Weinstein, University of Arizona

**Performative Environments** encompasses a range of topics and scales, from building components to buildings, from urban to landscape performances, and from structural, environmental, and material systems to information networks. While technological performances of built environments may be the dominant framework through which performance has been conceptualized, architecture and built environments succeed or fail according to a broad spectrum of performance criteria including the aesthetic, social, cultural, economic, as well as space's political production and its inhabitation. The concept of performative environments, therefore, not only posits that people create and act upon buildings, but also that environments have agency of their own. Space performs!

The ARCC 2021 International Conference gathered a broad and entangled series of presentations under three thematic umbrellas—*technological*, *cultural* and *organizational*. This organization was modeled after performance studies scholar and opening plenary panelist Jon McKenzie's "rehears(ed) general theory of performance," reinterpreted to challenge environments: "Perform—or else." The technological, cultural and organizational sub-themes built upon many other designers' and scholars' work that has broken disciplinary boundaries to examine the complexities of performance in spatial culture, research, pedagogy, and/or practice. The papers and abstracts assembled in these proceedings evidence the diversity of research on how environments are performing and how research in and through environments is being performed.

### **Session Topics**

#### > Technological Performances

Research concerning the built environment's technological performances navigates between nano and planetary scales, and interrogates methods, materials, and media; ethics and aesthetics; and efficacy, efficiency, and affect. Histories of architectural technologies reveal oscillations and cross-pollination between mechanistic and organic paradigms and range from single-issue, scientific research to more holistic, complex models. With shifts from inert to vibrant matter paradigms, both materials and material systems perform multiple functions, generating and integrating information flows, and behaving according to biological models in dialogue with humans. Ecological and socio-economic imperatives alert us to the ethics of material extraction, supply chains, by-products, and life cycles, and bring into view architecture's myriad durational performances beyond biome-specific, seasonal adaptations.

Architects and engineers have devised technological solutions to varying environmental conditions through contextual responses and socio-cultural behaviors, as well as ones abiding by universal laws of physics. Histories of energy and buildings expose shifting stances from the earliest place-based climate-protective structures, through strict environmental management and control, to adaptive and responsive systems. The interconnected roles of materials and spatial design greatly influence the energetic performance, as does the occupant culture. In a context of climate crises and global pandemics, design of environments across scales with a focus on the health of diverse life-forms in our biosphere presents the possibility of catalyzing positive planetary transformation. How do we process, measure, visualize, and simulate these issues? How do methodologies that investigate and represent our complex world frame technological research?

#### > Cultural Performances

While environments may perform as places for scripted events playing out before an audience, urban sites, spaces, buildings, and landscapes have the potential to be more than mere locations. They are events in themselves. Cultural performances of environments are enacted through daily practices and recurrent ritual. They embody cultural traditions. They challenge and transform through improvisation and agency. Mis-performed iterations, durations, *dérives*, and repetitions are generative. The event may, in fact, not be that which is planned, but the punctual, unscripted, and unintended irruptions that the liminal space time of the event affords. Human and non-human performances in space are discursive in that space impresses assumed behaviors upon us even as we exert our agency to be and perform in and with space. Environments perform upon senses, moving embodied beings, choreographically and emotively, through immersive atmospheres experienced over time. The dialogue between bodies and environments establishes and evidences culture. The media, be they environments themselves, models, drawings, or films, constitute the message and the meaning. These dialogue with us, conveying ideas, social hierarchies, desires, and values. Materials translate cultural attributes and aspirations; visual and textual narratives recount (hi)stories. Building materials, spatial configurations, and representations parlay cultural conditions that reveal social values, modalities, and forms. Tactical assemblies of bodies with public spaces—protest, occupations, demonstrations, and flash-mobs—enact emerging cultural conditions. How are critical spatial performances particularly pertinent amidst augmented policing of roundabouts, boulevards, and boundaries under past, present, and future states of emergency; in a context of self-sequestering and spatial re-partitioning in response to pandemics; and in the shifting spatial practices that respond to climate crises?

> Organizational Performances

Over the course of modernization, institutional performances have shifted modes from Taylorism to performance management under the rules of socialism, capitalism, and neoliberalism. Contemporary organizational performances are exemplified by the “new (entrepreneurial) spirit of capitalism” through mechanisms of out-sourcing, flex-timing, multi-tasking, and by networks of creatives gathered on a (precarious) project basis. Undergirding these historical shifts and varied institutional forms are social and managerial hierarchies shaping mutually dependent relationships as well as operational and aspirational ideologies.

Techniques of measurement govern and guide institutions (from families to universities, corporations, and governments), operating through social rituals and media. Informed by feedback loops and performance reviews, institutions and individuals adapt to shifting, complex, and conflicting forces. Built environments are integral to the formation, growth, maintenance, or closure of institutions. Organizational performances include institutions’ social structures and purposes, their representations through architecture and other media, the importance of metrics and performed values, and the social-spatial-economic-political rituals of foundation. As organizations’ characteristics inflect how practice and research are performed, the contexts of performance matter, be they architectural practices, building sites, user milieu, or those of research and teaching. Architectural offices and academies depend on a spectrum of forms of labor, and thus how designers organize labor practices and working teams, both internal to firms and in dialogue with governing authorities, matter. How have experiments in organizational performances yielded new theoretical models, processes, and designs?

**Acknowledgments**

The theme of this conference originated in 2019 when School of Architecture faculty at the University of Arizona imagined how a conference concerning “performance” could organize and present many of the questions we were asking about our work. A natural partner for this project was ARCC – an organization dedicated to architectural research. Two years later, amid a pandemic, we present the results of this endeavor.

As co-chairs of the conference, we are thankful to the many people who contributed to the success of the conference. Nancy Pollock-Ellwand, Dean of College of Architecture, Planning, and Landscape Architecture and Robert Miller, Director of the School of Architecture at the University of Arizona committed to this endeavor. The conference planning committee, including Jonathan Bean, Susannah Dickinson, Altaf Engineer, Laura Hollengreen, and Aletheia Ida, crafted the call and curated components of the conference experience. CAPLA IT leaders Lucas Guthrie and Adam Katz, as well as Simmons Buntin, provided vital technical support along with other staff members in the college. Additionally, School of Architecture staff member Greg Ruffing and the following students assisted with the smooth sailing during conference days: Emily Ahlgren, Rudy Chon, Nahal Entezam Nia, Sara Ghaemi, Anisa Herмосillo, Sam Owen, Anjali Ramohalli, Mehli Romero, Anahita Modrek and Zoe Sadorf. Finally, we also thank UA faculty Kaitlin Murphy (SCCT) and Colin Blakely (Art) and graduate and doctoral students from Art, Architecture and Humanities for their contributions to the seminar with Eyal Weizman.

The conference graphics incorporate original photography by UA Professor David Taylor, MFA student David Baboila, and Associate Professor Susannah Dickinson. These were woven into a visual identity developed by architecture student Rachael Varin with Susannah Dickinson’s guidance.

This conference would not have been, but for the original research by all of those who responded to the call and developed their ideas for presentation and publication. To punctuate our exchange, we invited Eyal Weizman, Peggy Deamer and Michelle Addington as keynote speakers to challenge us to perform research and research performance otherwise. We invited Jon McKenzie, Billie Faircloth and Nicolas de Monchaux to open this event, and to expand the boundaries of our fields of inquiry. And we set another challenge to closing plenary speakers—Mae-ling Lokko, Mona El Khafif and Gray Read, plus Michelle Addington—to gather up and make sense of the many threads of research presented here. Last, we thank the ARCC, its Board of Directors, and particularly President Chris Jarrett, Vice President Adil Sharag-Eldin and Past-President Hazem Rashed Ali for their guidance and support to realize this 2021 Conference: Performative Environments.

With our gratitude,

Conference co-chairs Clare Robinson and Beth Weinstein

# PERFORMATIVE ENVIRONMENTS

**Keynote Speakers + Panelists**  
ARCC 2021 International Conference



## Eyal Weizman

Goldsmiths, University of London, Forensic Architecture



Tear gas is used to disperse bodies gathering in democratic protest, white phosphorus and chlorine gas are used to spread terror in cities, herbicide is sprayed from airplanes to destroy fields and displace those whose livelihood depends on them, arson is used to eradicate forests for industrial plantations. Mobilized by state and corporate powers, toxic clouds colonize the air we breathe across different scales and durations, from urban squares to continents and from incidents to epochal latencies.

Studying such contemporary clouds necessitate a different approach to the analysis of kinetic encounters where “every contact leaves a trace”. Clouds are the epitome of transformations and their dynamics are elusive, governed by nonlinear and multi-causal logics. This is a problem that originated throughout the history of painting, when clouds were moving faster than the painter’s brush could capture them. and sometimes needed to be conceived rather than described.

Indeed, today’s toxic fog breeds lethal doubt and cloud shifts once more from the physical to the epistemological. When naysayers operate across the spectrum to deny the facts of climate change just as they do of chemical strikes, those inhabiting the clouds must find new ways of resistance.

*Eyal Weizman is Professor of Spatial and Visual Cultures and founding director of the Centre for Research Architecture at Goldsmiths, University of London. In 2010 he founded the research agency Forensic Architecture and directs it ever since. The work of the agency is documented in the exhibition and book FORENSIS (Sternberg, 2014), as well as in Forensic Architecture: Violence at the Threshold of Detectability (Zone/MIT, 2017) and in numerous exhibitions world wide. In 2007 he set up, with Sandi Hilal and Alessandro Petti, the architectural collective DAAR in Beit Sahour/Palestine. This work is documented in the book Architecture after Revolution (Sternberg, 2014). In 2013 he designed a permanent folly in Gwangju, South Korea which was documented in the book The Roundabout Revolution (Sternberg, 2015). His other books include The Conflict Shoreline (Steidl and Cabinet, 2015), Mengele’s Skull (Sternberg, 2012), The Least of all Possible Evils (Verso, 2011), Hollow Land (Verso, 2007), A Civilian Occupation (Verso, 2003). Weizman is on the editorial board of Third Text, Humanity, Cabinet and Political Concepts and is on the board of directors of the Centre for Investigative Journalism (CIJ) and on the Technology Advisory Board of the International Criminal Court (ICC) in The Hague. He previously sat on the advisory boards of the ICA in London and B’Tselem in Jerusalem, amongst others. He graduated in architecture in 1998 from the Architectural Association in London and completed his PhD at the London Consortium/Birkbeck College in 2006.*

**Peggy Deamer**  
Yale University, Architecture Lobby



This keynote talk is structured into three parts, each of which addresses three facets of political production/architectural performance: first, an analysis of how architecture is organized as a profession; second, an exploration of how architecture is organized as a discipline; and, third, an introduction to an activist organization trying to perform architecture differently.

The first section analyzes how our architectural profession in the US is organized through three aspects of our professional structure. The first of these deals with the concept of professionalism and its origins in the 19th century, its transformation in the 20th century, and current critiques of professionalism in our current socio-economic structure. The second deals with the AIA as our particular professional organization, suggesting the structural attributes that make it weak - structures both externally and self-imposed. The third looks at professional architectural organizations in other countries to see what the AIA might learn from them as well as what we, as architectural citizens, learn about the embeddedness of our profession in national hegemonies.

The second section explores how architecture is organized as a discipline, and specifically examines how our architectural education prepares us for a marginalized and unrewarding profession. It looks at three culprits of the academic construct. The first is its 19th century, Beaux-Arts approach to architectural education that emphasizes aesthetic virtuosity, individuality, and heroic programs. Its associated perspective identifies design teaching that, in the Beaux-Arts model, disengages “design” from social, economic, and political issues is the second culprit. And the final aspect focuses on the way we “perform” pedagogical instruction – a performance of intimate hierarchy.

The third section introduces an activist organization—the Architecture Lobby—and looks at the Architecture Lobby’s efforts to work-around capitalist, developer-driven forces which lead to our performing unsatisfying and unrewarding work. Amongst the issues discussed are efforts at unionization, cooperativization, and the role of architectural labor in the Green New Deal.

This analysis of the profession, exploration of the academic discipline and discussion of an activist organization will conclude with thoughts on what is really at the center of “performing” architecture.

*Peggy Deamer is Professor Emerita of Yale University’s School of Architecture and principal in the firm of Deamer, Studio. She is the founding member of the Architecture Lobby, a group advocating for the value of architectural design and labor. She is the editor of Architecture and Capitalism: 1845 to the Present and The Architect as Worker: Immaterial Labor, the Creative Class, and the Politics of Design and the author of Architecture and Labor. Articles by her have appeared in Log, Avery Review, e-Flux, and Harvard Design Magazine amongst other journals. Her theory work explores the relationship between subjectivity, design, and labor in the current economy. Her design work has appeared in HOME, Home and Garden, Progressive Architecture, and the New York Times amongst other journals. She received the Architectural Record 2018 Women in Architecture Activist Award and the 2021 John Q. Hejduk Award.*

**Michelle Addington**  
University of Texas at Austin



Material and performance research in Architecture is often entangled in a methodological network constrained by missing knowledge, unsupported by foundational methods, clouded by conflicting domains, and untethered to meaningful impacts. The robust academic structure that both undergirds as well as overarches the research enterprise that forms the fundamental core of most disciplines, and should be that which frames and guides our research activities, is all but missing from our field. There is no consistent development and progression from undergraduate to graduate to doctorate to post-doctorate to faculty; what we have instead are small *ad hoc* fragments scattered about the world—a bespoke independent study program advertised as a research master’s degree. A funded special initiative that is singularly self-contained either as a unit or as a faculty members lab. While canon in architectural history is certainly being questioned, we know the extents of the field and what it considers as its principles and governing criteria. We cannot say the same about material and performance research in Architecture. Academic research both governs canon and is governed by canon. Without canon, there is no stable ground from which to launch an investigation, to open up an inquiry, to dismantle an accepted belief. Without canon as stable ground, then the starting point becomes that which we do and that which we are familiar with—aka practice and precedent.

Much of what we call research is thus incremental and relative, which is not to discount it as incremental research is certainly considered a worthy undertaking. But we are often left without a clear and meaningful beginning and ending point for what drives the iteration other than the desire to try something or to make something. Even when research is intended to tackle a grand challenge, such as climate change, we tend to allow precedent and practice to co-opt the starting point and the ultimate question, keeping us bound to the way that we do things, albeit with some possible improvements. Big questions devolve into minor adjustments if we even are able to implement the results. More often than not, we aren’t able to implement results beyond prototyping or demonstration

A robust research structure allows for questions large and small, enables methods that are repeatable and verifiable, establishes paths for dissemination that range from knowledge building to implementation to definitive (and verified) contribution. But we don’t have such a structure and we don’t have the critical mass or canonic foundations to build one. For too long, we have tried to cobble together some semblance of a research structure for investigating materials and performance: a grant here and there, a few dozen doctorates, some experimental work carried out by firms, a scattershot of engineering-like papers appearing in numerous journals. For too long, many of us have been critical of what we perceive as the lack of rigor in how we educate architects in the questions and methods of research as well as in what qualifies as the products of research. Maybe it is time to stop trying to fit into the normative research structure that is the backbone of the more atomized disciplines, and build a research ecosystem that truly capitalizes on what knowledge we do bring to the table, what unique skills and capabilities we can bring to bear, how we fluidly collaborate and embrace enormous breadth across disciplines. What could and should it be?

*Michelle Addington is dean of The University of Texas at Austin School of Architecture, where she holds the Henry M. Rockwell Chair in Architecture. Formerly, she served as Gerald Hines Chair in Sustainable Architectural Design at the Yale University School of Architecture and was jointly appointed as a Professor at the Yale University School of Forestry and Environmental Studies. Prior to teaching at Yale, she taught at Harvard University, Technical University of Munich, Temple University and Philadelphia University. Originally educated as a mechanical/nuclear engineer, Addington worked for several years as an engineer at NASA/Goddard Space Flight Center and for E.I DuPont de Nemours before she studied architecture. Her teaching, research, and professional work span across these disciplines with the overarching objective of determining strategic intersections between the optimal domains of physical phenomena with the practical domains of spatial, geo-political, economic, and cultural systems. Her books, chapters, essays, journal papers, and articles address topics ranging from fluid mechanics to the History of Technology to smart materials, and she has consulted on projects as diverse as the Sistine Chapel and Amazon rain forest. Addington holds a B.S.M.E. from Tulane University, B.Arch from Temple University, and M.Des.S. and D.Des. degrees from Harvard University. She also holds an honorary M.A. from Yale University. In 2009, she was selected as one of the country’s top ten faculty in architecture by Architect Magazine, and, in 2014, she was named as one of Connecticut’s “Women of Innovation.”*

### **Billie Faircloth, FAIA**

Partner, KieranTimberlake

Billie Faircloth is a practicing architect, educator, and partner at KieranTimberlake, an award-winning architecture firm recognized for its environmental ethos, research expertise, and innovative design. As the firm's Research Director, she leads a transdisciplinary group of professionals leveraging research, design, and problem-solving processes from diverse fields including environmental management, chemical physics, materials science, and architecture. She oversees the queries and investigations that begin and inform each project at the firm. Billie is currently an adjunct professor of architecture at the University of Pennsylvania Stuart Weitzman School of Design and has served as the Barber McMurry Professor at University of Tennessee, Knoxville, and VELUX Visiting Professor at the Royal Danish Academy of Fine Arts. She is the recipient of Architectural Record's Women in Architecture Innovator Award in 2017.



### **Jon McKenzie**

Cornell University

Jon McKenzie researches and teaches media and design in Cornell University's Department of English and is also faculty affiliate of the Bronfenbrenner Center for Translational Research. He is Director of StudioLab, an experimental pedagogy and design consultancy, and author of *Transmedia Knowledge for Liberal Arts and Community Engagement: A StudioLab Manifesto* (2019) and *Perform or Else: From Discipline to Performance* (2001). He is also co-editor of *Contesting Performance: Global Sites of Research* (2011), as well as founder and former director of DesignLab, a design consultancy for higher education at Madison. Alongside books and articles, Jon also produces experimental videos, lecture performances, and theory comics, and leads workshops on transmedia knowledge for researchers, public schools, and community organizations. His work can be found at [labster8.net](http://labster8.net).



### **Nicholas de Monchaux**

Massachusetts Institute of Technology

Nicholas de Monchaux is Professor and Head of Architecture at MIT. He is a partner in the architecture practice modern, and a founder of the design technology company Local Software. Until 2020 he was Professor of Architecture and Urban Design, and Craigslit Distinguished Chair in New Media at UC Berkeley. De Monchaux is the author of *Spacesuit: Fashioning Apollo* (MIT Press, 2011), an architectural and urban history of the Apollo Spacesuit, winner of the Eugene Emme award from the American Astronautical Society and shortlisted for the Art Book Prize, as well as *Local Code: 3,659 Proposals about Data, Design and the Nature of Cities* (Princeton Architectural Press, 2016). In 2012 he was named one of the "Public Interest Design 100" by *Good Magazine*. His design work has been exhibited widely, including at the Biennial of the Americas, the Venice Architecture Biennale, The Lisbon Architecture Triennial, SFMOMA, the Yerba Buena Center for the Arts, the Storefront for Art and Architecture and the Museum of Contemporary Art in Chicago. His work has been supported by MacDowell, the Santa Fe Institute, the Smithsonian Institution, the Hellman Fund, and the Bakar Spark Fund. He is a Fellow of the American Academy in Rome.





**Mona El Khafif**  
University of Virginia



Mona El Khafif [Dr. techn. Dipl. Ing.], Associate Professor at UVA School of Architecture and Principal of SCALES SHIFT, received her professional degree in Architecture from the RWTH Aachen and her doctoral degree in Urban Design from the TU Vienna. El Khafif taught at the TU Vienna at the Institute for Urban Design and Landscape Architecture [2000-2006], Tulane University [2006-2008], California College of the Arts [2008-2013], and the University of Waterloo [2013-2016], where she co-directed the school's DATA Lab. She is co-author of 'URBANbuild: Local/Global' and author of 'Staged Urbanism'. Her research operates at multiple scales, examining the interdisciplinary aspects of urban design, creative place making, urban prototyping, and strategies for the smart city. At UVA El Khafif serves as the director of the urban design programs and leads a series of research projects. Among those the recently funded NSF Grant MainStreet21 supporting a network of small and midscale cities in Virginia through digital tools and Networked Public Space that was funded through the University of Virginia.

**Gray Read**  
Florida International University



Gray Read is an associate professor at Florida International University and holds a PhD from University of Pennsylvania. Her research focuses on historical strategies for urbanism that draw on the dramatic arts to design buildings and public spaces for the city. She is the author of *Modern Architecture in Theater: The Experiments of Art et Action* (2013), and co-editor of *Architecture as a Performing Art* (2014). Her recent work explores teaching and drawing techniques at the intersection of architecture and theater.

**Mae-Ling Lokko**  
Rensselaer Polytechnic Institute



Mae-ling Lokko is a designer and building materials technology researcher from Ghana and the Philippines whose work centers on the upcycling of agrowaste and biopolymer materials into clean building material systems. Lokko teaches seminars on energy and ecology in the built environment, upcycling, and eco-effective material life cycle design at Rensselaer's SoA and the Center for Architecture, Science and Ecology in Industry City, Brooklyn. Her work was nominated for the Visible Award 2019, the Royal Academy Dorfman Award 2020, and a finalist for the Hublot Design Prize 2019. Lokko's recent projects have been exhibited globally; in 2020, at the Somerset House, London and the Triennale Milano and, in 2019, at the Serpentine Gallery, London, Radialsystem, Berlin, and the Luma Foundation, Arles. Her work has been featured in Blueprint, Frieze Magazine, RIBA Journal, DOMUS, DAMN Magazine and other design publications. Lokko holds a Ph.D and MS in Architectural Science from the Center for Architecture, Science and Ecology at Rensselaer Polytechnic Institute and a B.A from Tufts University. She is also the founder of Willow Technologies, Ltd., an agrowaste company based in Accra, Ghana.





# PERFORMATIVE ENVIRONMENTS

**Research Papers**

**ARCC 2021 International Conference**

## > TECHNOLOGICAL PERFORMANCES

<i>Façade Performance, Research Methods and Models</i>	Page No.
<b>A Time Efficient Design Method for a Kinetic Façade Using a Regression Model</b> Ok-Kyun Im, Kyoung-Hee Kim University of North Carolina at Charlotte, Charlotte, NC	1-6
<b>Building Enclosure and its Outdoor Thermal Behaviour: <i>In situ</i> Measurement Efficacy</b> Patricia N. Kio, Ahmed K. Ali Texas A&M University, College Station, TX	7-14
<b>Facade Performance Study of a Historically Significant Brutalist Building: Thermal and Moisture Analysis</b> Suncica Milosevic, Ajla Aksamija University of Massachusetts, Amherst, MA	15-22
<i>Public Health and Well-Being</i>	
<b>Built and Social Environment Impact on Covid-19 Transmission</b> Ming Hu, Jennifer Roberts, Gesine Pryor Azevedo, David Milner University of Maryland, College Park, MD	23-30
<b>Intentional and Unintentional Performance: Analyzing the Validity and Agency of Ancient Environmental Design on Contemporary Architecture Advancement</b> Sandra Maria Bernal Cordova, Joaquin Murrieta-Saldiva, Ivan Eladio Gaxiola Camacho University of Arizona, Tucson, AZ Watershed Management Group, Inc., Tucson, AZ	31-38
<b>Salutogenesis + Design: Pursuing an Architecture of Wellness in an Age of Illness</b> Brian R. Sinclair University of Calgary, sinclairstudio inc., Calgary, CANADA	39-46
<i>Design Integrated CFD and Energy Performance</i>	
<b>A Framework for the Integration of CFD into the Early Stages of Architectural Design</b> Soo Jeong Jo, James Jones Virginia Tech, School of Architecture + Design, Blacksburg, Virginia Louisiana State University, School of Architecture, Baton Rouge, Louisiana	47-54
<b>Integrating CFD with ANN to Maximize Electricity Generation from the Wind Turbine Pavilion</b> Yun Kyu Yi, Keunhyuk Jang, Andrew Chun-An Wei, Bhujon Kang, Manal Anis University of Illinois, Urbana-Champaign, IL	55-62
<b>Energy Performance of Solar-Reflective Building Envelope on Retail Strip Malls - A Case Study</b> Roja Rastegar, Jae Chang University of Kansas, Lawrence, KS	63-70

**> TECHNOLOGICAL PERFORMANCES** (continued)

<i>Retrofit Measures, Systems and Solutions</i>	Page No.
<b>A Retrofit Scenario Analysis of Wall Systems and Materials of a Low-Rise Commercial Building</b> Ash Ragheb Lawrence Technological University, Southfield, MI	71-76
<b>Cost-Effective Net-Zero Energy Retrofit Measures for Existing Buildings in Cold Climates</b> Hossam Mahmoud, Ajla Aksamija University of Massachusetts, Amherst, MA	77-84
<b>Assessment of Deep Façade Retrofit Solutions for Housing</b> Ming Hu University of Maryland, College Park, MD	85-94
<i>Thermal Perception, Boundaries and Comfort Assessment</i>	
<b>Performative Environments of Alliesthesia: Thermal Perception in Solar Screened Offices Under Different Sky Conditions</b> Niyati Naik, Ihab Elzeyadi, Virginia Cartwright University of Oregon, Eugene, OR	95-102
<b>Shape-Shifters: Mobile Thermal Boundaries for Variable Occupancies in Native American Homes</b> Malini Srivastava University of Minnesota, Twin Cities, MN	103-110
<b>Thermal Preference and Comfort Assessment: Historic Buildings in Hot and Humid Climates</b> Ezgi Bay, Antonio Martinez-Molina Illinois Institute of Technology, Chicago, IL University of Texas, San Antonio, TX	111-118
<i>Energy, Evaluation and Material Production</i>	
<b>Impacts of Buildings' Energy Data Adjustment on CBECS-benchmarking Evaluations</b> Mahsa Farid Mohajer, Ajla Aksamija University of Massachusetts, Amherst, MA	119-126
<b>Push and Pull of Policy: Qualified Allocation Plans and the Design of Subsidized Dwellings</b> Christina Bollo University of Illinois Urbana-Champaign, Urbana, IL	127-134
<b>Kawneer's "Machines for Selling" Modernism in the Post-war United States</b> Tait Johnson University of Illinois at Urbana-Champaign, Urbana, IL	135-142

> **TECHNOLOGICAL PERFORMANCES** (continued)

<i>Daylighting, Empirical Predictions and Environmental Factors</i>	Page No.
<b>From Perception to Design: Daylight Glare Mitigation in Architectural Spaces</b> Tasbeeh Alaqtum, Altaf Engineer, Colby Moeller University of Arizona, Tucson, AZ AIA, LEED AP, Tucson, AZ	143-150
<b>Model Calibration for Circadian Daylighting in ALFA: Developing Empirical Circadian Predictions in Physical Scaled Model</b> Sara Sahebghalam, Adil Sharag-Eldin Kent State University, Kent, OH	151-158
<b>A Pilot Study on the Contextual and Environmental Factors Influencing Window Shading Preference</b> Anupam Satumane, Siobhan Rockcastle Baker Lighting Lab, University of Oregon, Eugene, OR	159-166
<i>Matter, Materials and Manufacturing</i>	
<b>Non-Rigid Formwork System for Sustainable Concrete Construction</b> Giovanni Loreto, Arash Soleimani, Lauren Stewart Kennesaw State University, Marietta, GA Georgia Institute of Technology, Atlanta, GA	167-174
<b>Plasticized Design: Fusing Plastic Chemistry and Architectural Design to Address Health Impacts</b> Joiana Hooks University of Minnesota, Minneapolis, MN	175-182
<b>Investigating Scales of Performance: Mycelium Ecomanufacturing in Dhaka's Urban Settlements</b> Iffat Ridwana, Mae-ling Lokko University of Cincinnati, Cincinnati, OH Rensselaer Polytechnic Institute, Troy, NY	183-190
<i>Thermal Performance, Energy Use and Visualization</i>	
<b>Adaptive Model Conditions for Thermal Comfort in Schools: Riverside, California   Lima, Peru   Nairobi, Kenya</b> David Mwale Ogoli California Baptist University, Riverside, CA	191-198
<b>Automated Energy Use Data Collection and Visualization for Game-based Education</b> Philip Reim, Yang Song, Malini Srivastava North Dakota State University, Fargo, ND Texas A&M University, College Station, TX University of Minnesota, Minneapolis, MN	199-206
<b>Visualizing Thermodynamic Flows in Architectural Research: Waste Heat Utilization in Data Centers</b> Sara Ghaemi, Aletheia Ida University of Arizona, Tucson, AZ	207-214

> **TECHNOLOGICAL PERFORMANCES** (continued)

<i>Urban Environments, Evaluation and Assessment</i>	Page No.
<b>User-Driven Emergent Patterns of Space Use in Vertically Integrated Urban Environments</b> Srilalitha Gopalakrishnan, Daniel Wong, Ajaykumar Manivannan Roland Bouffanais, Thomas Schroepfer Singapore University of Technology and Design, Singapore University of Ottawa, Ottawa, Canada	215-222
<b>Developing Life Cycle Assessment (LCA) System Boundary Guidelines for Comparable City Evaluations</b> Hala Alfalih, Tarek Rakha Georgia Institute of Technology, Atlanta, GA	223-230
<b>Urban Heat Island Phenomenon: A Review and Comparison of Assessment Methodologies</b> Aysem Berrin Cakmakli, Hazem Rashed-Ali Middle East Technical University, Turkey The University of Texas at San Antonio, TX	231-238
<i>Methods of Sustainability, LEED and Performative Environments</i>	
<b>Methodology to Incorporate the Value of Sustainability in Buildings</b> Sandra Guerrero, Irene Marincic University of Sonora, Hermosillo, Sonora, Mexico	239-246
<b>LEED-certified Buildings Versus Non-LEED-certified Buildings: A Deep Dive into the Performance</b> Ming Hu University of Maryland, College Park, MD	247-254
<b>From Nano to Building Scale: Design and Fabrication of Acoustical Diffusers based on Quasi-crystalline Atomic Structure</b> Rima Ajlouni University of Utah, Salt Lake City, UT	255-262

## > CULTURAL PERFORMANCES

<i>Meaning, Memory and Place</i>	Page No.
<b>Sacrality, Space + Self: Critical Explorations of Meaning, Relationship + Resonance in Islamic Architecture</b> Nooshin Esmaeili, Brian R. Sinclair University of Calgary, Canada sinclairstudio inc., Calgary, Canada	263-274
<b>Qal'at Sim'an, A New Venue of Power in Late Antique Syria</b> Laura Hollengreen University of Arizona, Tucson, AZ	275-282
<b>Bangladeshi Immigrant Muslim Women's Memories from Past-lived Homes: Their Ways of Knowing Spaces</b> Mania Tahsina Taher University of Wisconsin-Milwaukee, Milwaukee, WI	283-290
<i>Bio-design, Linguistics and Social Change</i>	
<b>Towards a Post-Anthropocene Bio-Design Practice</b> Assia Stefanova Newcastle University, Newcastle upon Tyne, UK	291-298
<b>Utterances and Similes: An Exploration of Participation and Linguistics in Architecture</b> Noémie Despland-Lichtert, Brendan Shea Texas Tech, Lubbock, Texas	299-304
<b>New Reality. New Architecture.</b> Salah Imam, Brian R. Sinclair University of Calgary + Entuitive Consulting Engineers, Canada University of Calgary + sinclairstudio inc., Canada	305-312
<i>Public Space, Parks and Performative Possibilities</i>	
<b>Ostenda illuminata: A Socio-Ecological 1:1 Prototype for Networked Public Spaces</b> Mona El Khafif, Andrew Mondschein, Luis Felipe R. Murillo University of Virginia School of Architecture, Charlottesville, VA University of Virginia School of Data Science, Charlottesville, VA	313-320
<b>From String of Pearls to String of Parks: The Compelling Case of Doha, Qatar</b> Asmaa Saleh AL-Mohannadi, Brian R. Sinclair, Raffaello Furlan, Rashid Saad AL-Matwi Qatar University, Doha, Qatar University of Calgary + sinclairstudio inc., Calgary, Canada	321-328
<b>Performance as Action. The Embodied Mind</b> Loukia Tsafoulia, Severino Alfonso Thomas Jefferson University, Philadelphia, Pennsylvania Universidad Politecnica de Madrid, Madrid, Spain National Technical University of Athens, Athens, Greece	329-336



> **CULTURAL PERFORMANCES** (continued)

<i>Representation, Improvisation and Visualization</i>	Page No.
<b>Online Bricolage: Toward an Architecture of Scavenged Means, Improvisational Methods and Decentralized Processes</b> Scott Shall Lawrence Technological University, Southfield, MI	337-344
<b>The Medium Isn't the Message Anymore: When the Renderings were Too Good to be True</b> Aaron Brakke University of Illinois, Champaign, IL	345-352
<b>On Conflicting Priorities Within Digital Models of Urban Form</b> Mike Christenson University of Minnesota, Minneapolis, MN	353-360
<i>Eco-Villages, Urban Infill and Corner Lot Housing</i>	
<b>Can Danish Ecovillages Demonstrate a Path to Reduce Domestic Energy Use?</b> Tersea Moroseos, Toke Haunstrup Christensen University of Washington, Seattle, WA Aalborg University, Copenhagen, Denmark	361-370
<b>The Checkerboard Charleston House: A Model for Passive Urban Infill Housing</b> Craig S. Griffen Thomas Jefferson University, Philadelphia, PA	371-378
<b>Intricate Compatibility: Study of a Hillside Lot in Tokyo</b> Chris Jarrett University of North Carolina at Charlotte, Charlotte, NC	379-386
<i>Representation, Perception and Pathfinding</i>	
<b>Synoptic Optics: Computational Representation at the Synoptic Scale</b> Stephen Mueller Texas Tech University, El Paso, TX	387-392
<b>Selective Attention and the Built Environment: Visual Perception of 2D Spatial Representations</b> Jennifer A. E. Shields California Polytechnic State University, San Luis Obispo, CA	393-400
<b>Cost in Space: A Value-Based Approach to Architectural Pathfinding</b> Jacklynn Niemiec, Steven Lilley Drexel University, Philadelphia, PA	401-406

**> CULTURAL PERFORMANCES (continued)**

<i>Territory, Landform and Performative Infrastructure</i>	Page No.
<b>Vision Machines of Territorial Control</b> Ersala Kripa Texas Tech University, El Paso, TX	407-412
<b>Performing Air: Landforms and Ventilation</b> Gabriel Fries-Briggs University of New Mexico, Albuquerque, NM	413-420
<b>Parks as Performative Landscapes: Networked Green Infrastructure for a Flooded Desert City</b> Courtney Crosson University of Arizona, Tucson, AZ	421-428

**> ORGANIZATIONAL PERFORMANCES**

*Performative Health, Biophilism and Well-Being*

<b>Situating Access and Breaking Boundaries: Holistic Responsivity as a Provocation</b> Bushra Hashim, Brian R. Sinclair University of Calgary, Calgary, Alberta, Canada	429-436
<b>Performative Views in Architecture: Preference, Composition, and Occupant's Wellbeing</b> Ihab M.K. Elzeyadi University of Oregon, Eugene, OR	437-444
<b>Biophilic Net-Positive Architecture: Integrating Nature, Health, Wellbeing and Passive Design</b> Mary Guzowski University of Minnesota, Minneapolis, MN	445-452
<i>Humanitarian Design, Public Health and Comparative Evaluation</i>	
<b>Imaginaries of Humanitarian Design: Material Versus Social Innovation in the Emergency Shelter</b> Natalie Florence Severy, Philip Plowright Arizona State University, Tempe, AZ Lawrence Technological University, Southfield, MI	453-460
<b>Evidence-based Health Centre Design Recommendations for the Malawi Ministry of Health</b> Chris Harnish, Anthony Elia, Josh Harmony Thomas Jefferson University, Philadelphia, PA	461-468
<b>Design Evaluation and Public Health: Comparing Frameworks for Increased Health</b> Traci Rider, Pegah Mathur, Margaret van Bakergem North Carolina State University, Raleigh, NC	469-474

> **ORGANIZATIONAL PERFORMANCES** (continued)

<i>Community Participation and Decision-Making Practices</i>	Page No.
<b>Expanding Youth Opportunity Studio: Design Research Engaging Community Participants</b> Julia W. Robinson, Alysha C. Price University of Minnesota, Minneapolis, MN Price Dynamic, Minneapolis, MN	475-482
<b>Queering Arts-based Development</b> Laura Walker, Mike Styczynski, Other Work, Detroit, MI Lawrence Technological University, Southfield, MI	483-490
<b>The New Stewards: How Non-architects Shape Public Understanding and Decision-making of the Built Environment</b> Irene Hwang University of Michigan, Ann Arbor, MI	491-498
<i>Mobility, Multiscalar Design and Environmental Quality</i>	
<b>Climate Change and Design: Multiscalar Design Research in the Sonoran Desert</b> Susannah Dickinson, Aletheia Ida University of Arizona, Tucson, AZ	499-506
<b>Measuring the Impact of Environmental Quality on Elderly Residents' Cognitive Functioning – A Critical Review</b> Nasrin Golshany, Ihab Elzeyadi University of Oregon, Eugene, OR	507-514
<b>Walking the Walk: Pedestrian Mobility in Emerging Cities</b> Diana María Jiménez-Aguilar, Luisa María Gutiérrez-Sánchez, Rosa María Mendoza-Robles University of Sonora, Hermosillo, Mexico	515-522

**> RESEARCH POSTER ABSTRACTS**

Page No.

**The Design and Fabrication of Façade Panel Systems with Additive Manufacturing** 523-524

Tanner Theisen, Niloufar Emami  
Louisiana State University, Baton Rouge, LA

**Other Ways to Pay for the Public Life?**

Brett Louis Snyder, N. Claire Napawan  
University of California at Davis, Davis, CA

**Development of Window Apertures to Improve Ventilation in Educational Buildings**

Yun Kyu Yi, Manal Anis, Keunhyuk Jang  
University of Illinois at Urbana Champaign, Champaign, IL

**Exploring Changes in Needs for Students Housing After the Pandemic**

Jinoh Park  
University of Tennessee, Knoxville, TN

**Public Policies for Sustainable Social Housing in Northwest Mexico**

Dania Lizeth Castro Diaz, Jose Manuel Ochoa De la Torre  
Universidad de Sonora, Hermosillo, Sonora, MEXICO

525-526

**Performative Nomadicism and the No-Place**

Jessica Hanzelkova  
University of Waterloo, Waterloo, CANADA

**Site Net Zero Contemporegional Architecture – The Barn Haus in Utah**

Jorg Rügemer  
University of Utah, Salt Lake City, UT

**Assessment of Housing and Urban Context from an Aging in Place Framework and its Impact in the Quality of Life of Older Adults**

Margarita Ibarra Platt, Maria Guadalupe Alpuche Cruz  
Universidad de Sonora, Hermosillo, Sonora, MEXICO

**The Sound Pavilion**

Rachel Dickey  
University of North Carolina at Charlotte, Charlotte, NC

527-528

**Energy Performance Evaluation in the Design Process of Façade-Integrated Green Living Walls Using Digital Simulation**

Tazrin Islam, Ute Poerschke, Yasmine Abbas  
Pennsylvania State University, State College, PA

**Pilot Test of an Instrument for Vulnerability Assessment in Mexican Regulation, Case Study: Pharmaceutical Cleanroom**

Fernando Arvayo-Ballesteros, Oscar Armando Preciado-Perez  
Universidad de Sonora, Hermosillo, Sonora, MEXICO

**Methodology for the Evaluation of Sustainability in Real Estate**

Sandra Guerrero, (N) Irene Marincic  
Universidad de Sonora, Hermosillo, Sonora, MEXICO

- Spatial Improvisation Exercises for Architects** 529-530  
Gray Read  
Florida International University, Miami, FL
- Informal Health Access in Liminal Space**  
Ulysses Vance  
Temple University, Philadelphia, PA
- Human-Robot Interactive Synergy (HRIS)**  
Mona Hashemi, Ebrahim Poustinchi  
Kent State University, Kent, OH
- Classification of Natural Plant Physiology, Behavior and Morphology to Inform an Adaptive Architecture**  
Anahita Modrek, Kirk Dimond, Susannah Dickinson, Aletheia Ida  
University of Arizona, Tucson, AZ
- Building a Morphology in the Data of Things** 531-532  
Brian T. Rex, Mahmoud Sadek, Autumn Schlomer  
South Dakota State University, Brookings, SD
- Phoenix Performs!**  
Elena Rocchi  
Arizona State University, Tempe, AZ
- Cities or Urbanization? Urbanism as Object | City as Process: Pedagogical Permutations + Provocations of the In-Between**  
Brian R. Sinclair, Alberto de Salvatierra  
University of Calgary, Calgary, CANADA
- Development and Construction of the Field of Dreams Ecocommunity** 533-534  
Jorg Rügemer  
University of Utah, Salt Lake City, UT
- Designing Roofs to Support Native Plans in the Great Lakes Region**  
Meghan Blackson, Reid Coffman, Nick Safley, Christopher Blackwood  
Kent State University, Kent, OH
- Post-Revolutionary Discourse Reflected Through Architecture in Hermosillo, Sonora (1920-1950)**  
Anabel Leyva Hernandez, Juan Luis Loredó Lopez  
Universidad de Sonora, Hermosillo, Sonora, MEXICO
- Traditional Ecological Knowledge (TEK) as Performative Environments + Ecologies-Integrated Land-Based Learning into the Architectural Curriculum and Design Research**  
Shannon Bassett  
Laurentian University, Ontario, CANADA





# TECHNOLOGICAL PERFORMANCES





# A Time Efficient Design Method for a Kinetic Façade Using a Regression Model

Ok-Kyun Im<sup>1</sup>, Kyoung-Hee Kim<sup>1</sup>

<sup>1</sup>University of North Carolina at Charlotte, Charlotte, NC

**ABSTRACT:** The extensive use of glass is common in office towers due to its benefits from daylighting, view-outs, and contemporary aesthetics in urban settings. The building sector is among the largest consumers of energy and non-renewable resources. With current climate emergency and advances in technology around architecture, kinetic facade systems that are adaptable to environments and control microclimates is generating considerable interest. Finding an optimal operation of kinetic facades during early design process will improve energy consumption and occupant comfort. The purpose of this study therefore is to develop a time efficient design methodology that helps determine the optimum operation of kinetic facades. For this study, a kinetic shading system with circular units that rotates clockwise or counterclockwise depending on the sun's movement was developed. Solar radiation data simulated in Diva (a daylighting and energy simulation tool) was used to investigate varying degrees of regression models as a time efficient tool to find optimal operations of kinetic facades. The results of the study shows that the developed regression model shows different predictive results depending on time and season which is closely related to the altitude of the sun. When the sun's altitude is high, solar radiation can be blocked well by the kinetic system, so the amount of blocked solar radiation according to the rotation angle increases, which leads to the accuracy of the regression model. On the other hand, when the sun's altitude is low or the amount of solar radiation is relatively low compared to other times, the accuracy of the regression model is relatively reduced because the difference in solar irradiance across varying rotational angles are not large. Additional methodologies have been developed in improving the prediction accuracy of the regression model in solar performance of kinetic facades. Incorporating a regression model during kinetic façade design process could make the design process more time efficient without undergoing repetitive simulation process. It is also expected to further help multi-functionalities of kinetic facades with improved energy efficiency and occupant comfort.

**KEYWORDS:** Kinetic facade system, regression model, building facade performance analysis

## INTRODUCTION

Advancing building technologies and the architectural trend of pursuing a net-zero building have drawn an increased interest in kinetic facade systems as a building envelope system. Kinetic façade can improve the environmental performance of the building by responding to the changes of the external weather condition. A dynamic motion of the kinetic facade system plays an important role in architectural aesthetics. Its fundamental purpose of kinetic motions is to enhance the energy efficiency of building and provide a better indoor environment for the occupants. For example, if a kinetic facade system can control environmental factors affecting indoor temperature such as solar radiation, it can enhance the indoor thermal comfort and energy performance of a building. More specifically, a kinetic facade system can not only block solar radiation in summer, but also change its form or function to flow the winter solar radiation into the indoor space. With architectural and environmental benefits, various kinetic systems are being developed, and researches are being conducted to evaluate the performance of kinetic facade systems in the early design stage.

## 1.0 BRIEF LITERATURE REVIEW

Most of the performance evaluation of kinetic systems are carried out using simulation software. In particular, Grasshopper, a visual programming language for parametric modeling, is mainly used because its parametrial environment can reflect the feature of a kinetic facade motion. Moreover, several environmental simulation plug-ins for the Grasshopper such as Climate studio, Diva, Honeybee, Ladybug on the grasshopper environment can be directly applied to a parametric model to simulate the performance of a kinetic motion. Current simulation methods for the kinetic system are performed by repeating an iterative process. In other words, a kinetic motion is converted into several static conditions that are suitable for running simulation. For example, Mahmoud and Elghazi (2016) evaluated the indoor daylight conditions by the kinetic facade system through the simulation using DIVA. They suggested the kinetic facade system using the hexagonal units. In order to find an optimal condition at the specific time, they generated 10 different rotational angles from 30° to 165° with a 15° interval and compared the daylight performance of each rotational conditions. Wagdy, A et al.(2015) studied the kinetic performance of the kaleidocycle shape. In this research, they created 10 different opening ratios by controlling the rotation angle of the kaleidocycle unit from 0° to 90°. By reducing the interval of the rotation angle, the accuracy of the simulation can be increased, but this approach became a time-consuming process.



Regression analysis is a statistical technique that describes the relationship between the dependent variable to be predicted and one or more independent variables that affect the outcome. Energy simulations require to input many parameters for the calculation, which is a very time consuming and complex process. Therefore, many studies use regression analysis for predicting energy consumption due to its simplicity and accuracy. Korolija et al. (2013) developed a regression model to predict the annual energy consumption of UK office buildings using five different HVAC systems. In this study, a regression model was developed for each HVAC system, and a linear and a quadratic regression model were developed to compare the predictive performance from the regression equation. Asadi et al. (2014) developed a multiple linear regression model to predict the energy consumption of commercial buildings in the early design stage. In this research they classified the building type with 7 different forms and developed a multiple linear regression model for each building form. Therefore, the goal of this study is to develop a regression model that takes into account the kinetic feature of the facade system. Using Typical Meteorological Year (TMY) 1, 2, and 3 weather dataset and simulations, the study evaluates accuracy of the regression model developed from simulation data and compares the results across the three TMY weather data.

## 2.0 METHODOLOGY

This research consists of four steps. The first step was to develop a kinetic facade system which has a rotational movement for responding to different solar positions. The second step was to perform hourly solar irradiance simulations of the kinetic system with different rotational angles to collect the simulation data. In the third step, this research developed a multiple regression model using the simulation data from the previous step to predict the solar performance of the rotational kinetic motion of the system without running a simulation. The last step is to compare the result between the solar irradiance value predicted by the regression model in step three and the solar irradiance generated from the simulation to verify the accuracy of the regression model.

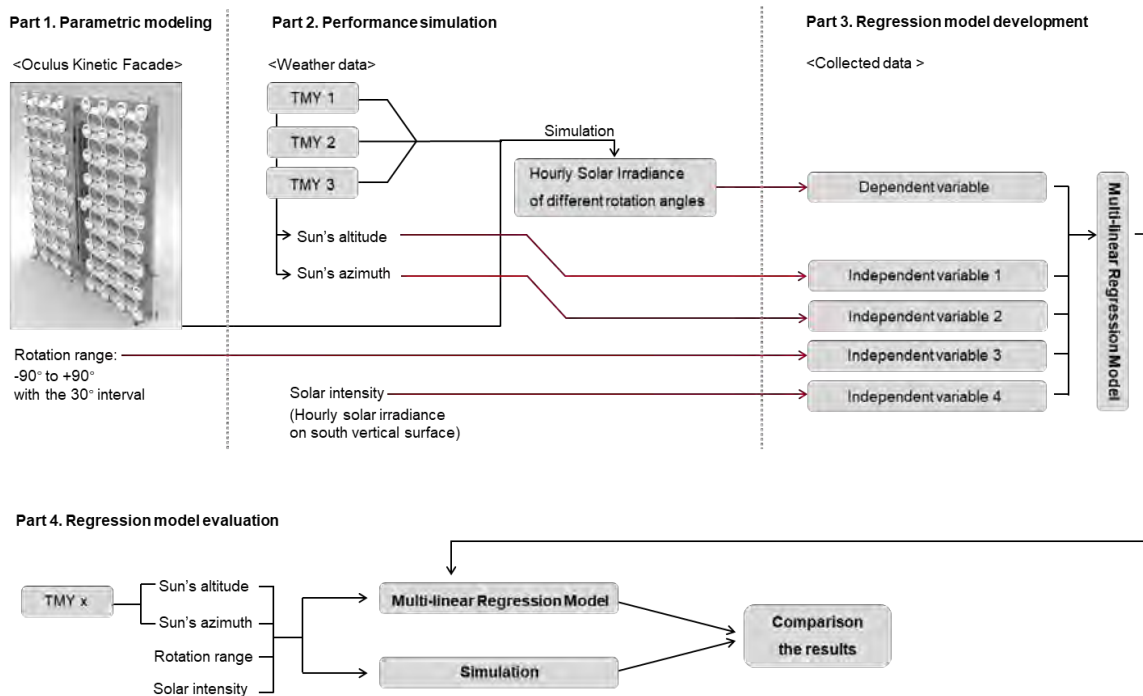


Figure 1: Research workflow to develop a regression model to predict solar performance of a kinetic facades (Author 2021)

## 2.1 Development of Kinetic facade system

The kinetic facade in this research consists of an oculus unit with outer and inner curved shades (Figure 2). The unit components is integrated with the circular gear frame and work as the shading device. By the rotational motion with the clockwise or counterclockwise, they can control the solar irradiance while providing daylight penetration and view-out. The figure below shows the geometry of the oculus kinetic unit. The oculus kinetic unit was integrated within the air cavity of an insulated glass unit (IGU) system (Figure 1).

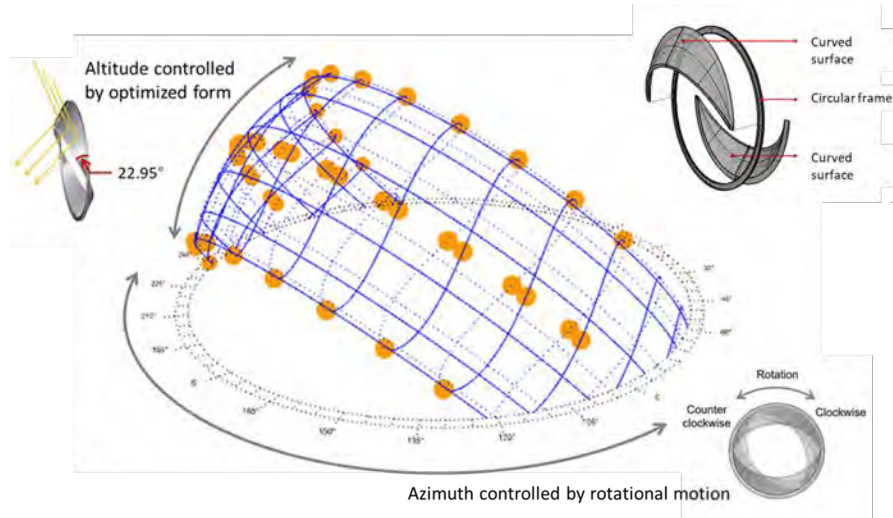


Figure 2: Oculus kinetic façade units consist of outer and inner curved shades which acts as a shading device; it controls solar radiation depending on seasons while providing daylight penetration and view-out (Author 2021)

**2.2 Performance simulation for hourly solar irradiance**

The main feature of the kinetic facade system is to effectively control the solar irradiance by rotational motion in accordance with the sun’s movement. Since the amount of solar irradiance reaching on the inner surface of the IGU has different values depending on the rotation angle of the system, the effectiveness of blocking solar irradiance can be evaluated by comparing the average solar irradiance of different rotational motions. Considering the sun’s movement, the range of rotational motion was limited between -90 degrees and + 90 degrees with 30 degrees interval (Figure 3). The simulation results were used as data for developing a regression model.

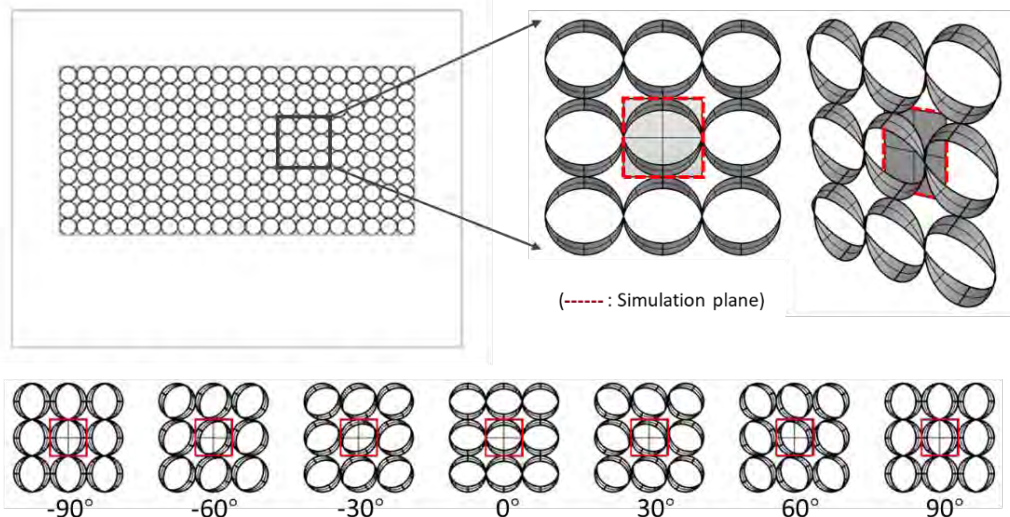


Figure 3: Varying rotation angles of oculus kinetic facade system for solar irradiance simulation (Author, 2021)

Diva, a grasshopper plug-in was utilized to carry out solar simulation on different parametric modeling conditions. A regression model was developed using the simulation data based on TMY 1 to 3 of Charlotte, NC which has a year range between 1955 and 1998. TMYx data, the latest weather data between 2006 and 2017, was utilized in the verifying stage to compare the result with the predicted value generated by the regression model. In other words, the weather data used to develop the regression model were TMY 1 to 3, and the weather data used for predicting the solar irradiance and verifying the accuracy of the regression model was TMYx. This comparative analysis indicated that the regression model developed using TMY1-3 can predict future performance of kinetic façade system without running performing simulation.

### 2.3 Data collection for developing a regression model

Hourly solar irradiance data of 7 different rotation angles for one year were simulated using weather database of TMY 1 to 3. The original number of simulated data was 183,960 based on 8760 hours for one year, 7 different rotation angles and 3 different collected year of weather data (TMY 1-3). By removing 0 solar irradiance value during the sunset hours, the final number of data set became 95529. Each simulated data contains the following variables to create a regression model: the sun's altitude, azimuth, solar intensity, rotation angle, solar irradiance. Among these, the four factors were selected as independent variables influencing the dependent variable, solar irradiance: sun's altitude and azimuth, solar intensity, and rotation angle. The solar irradiance was defined as the dependent variable. The sun's altitude and azimuth provide the hourly change of sun's position and the solar intensity indicates the solar irradiance value on the vertical surface without any obstacle. The rotation angle provides information on how the solar irradiance value varies depending on the rotation angle. For example, the figure below shows the difference in solar irradiance value according to the varying rotation angle at 12 pm on March 21st (Figure 4). When plotting the result of the solar irradiance for the different rotation angle, the graph pattern results in quadratic curve rather than a linear (Figure 4). In the case of rotational motion, since the graph pattern of solar irradiance value of different rotation angle indicates a curved condition rather than a linear, the regression model is converted into a quadratic regression model by the multiplication process of independent variables. Therefore, the quadratic regression model can predict a solar irradiance value accurately than the linear regression model.

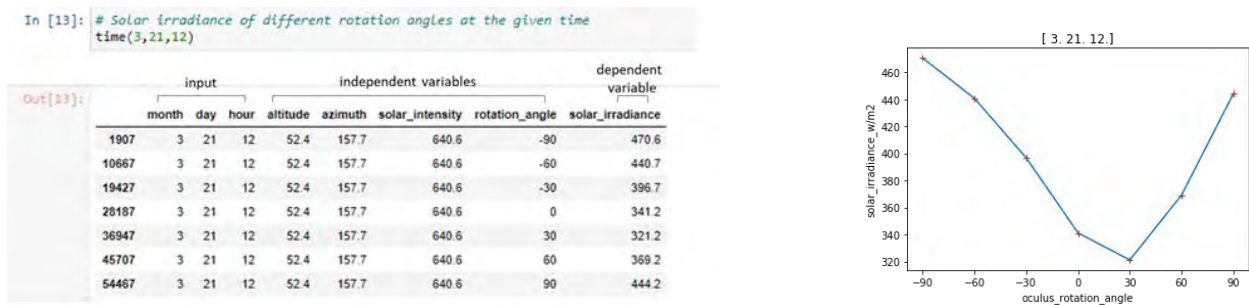


Figure 4: Data table containing information on independent and dependent variables (left) and visualized results of solar irradiance values of varying rotational angles at 12 PM on March 21st (right) (Author, 2021)

### 3.0 RESULTS

Through this process, the following quadratic regression equation was created using Ordinary least squares(OLS), one of the representative methods of making a regression model. Accuracy of the developed regression model was assessed by the coefficient of determination ( $R^2$ ), adjust R-squared (adj- $R^2$ ). Table 1 shows result of the regression analysis. The coefficient of determination ( $R^2$ ) indicates the proportion of the variance for the dependent variable which can be explained by the independent variables in the developed regression model. Therefore, a high  $R^2$  means that most applied data can be predicted by this regression model. For example, when  $R^2$  is equal to 1, it means that the regression predictions perfectly fit the data. If a  $R^2$  is close to 0, in contrast, it indicates that there is no relationship between the variables. Adjust R-squared is a value used to solve the problem of the R-squared value that increases as the number of independent variables increases. Therefore, the adjust R-squared is always equal or lower than the R-squared. In this case, the R-squared and Adj. R-squared values of this regression model have 0.946, which means only less than 6% of variance in the simulation data has not been accounted for by the regression model.

#### Quadratic regression equation ( $R^2 : 0.946$ )

$$(-3.66)*(1)+(0.42)*(a)+(-0.062)*(z)+(0.476)*(s)+(0.261)*(r)+(0.009)*(a**2) + (-0.001)*(a*z)+(-0.004)*(a*s)+(-0.0006)*(a*r)+(0.0001)*(z**2)+(0.0003)*(z*s) + (-0.0015)*(z*r)+(0.0003)*(s**2)+(0.0002)*(s*r)+(0.0031)*(r**2)$$

a: altitude, z: azimuth, s:solar intensity, r: rotation angle

Table 1. Quadratic regression model and OLS regression results (Author, 2021)

### 3.1 Prediction comparison of the regression model for 4 selected days of different season

The solar irradiance values predicted by the quadratic regression model for four days of different seasons were compared with the simulation results. In the graph below, the blue graphs represent the simulation result using TMYx data, and the red graphs indicate the predicted value by the developed regression model. Overall, it can be seen that the regression model accurately predicts the change in solar irradiance according to the season. In other words, the

graphs generated by the regression model (red color) are closely fitted with the simulation based graphs (blue color) except for the March case (Figure 5). In the case of March, both the graphs by the regression model and the simulation show a minimum solar irradiance value when rotation angles are between 0 and 30 degrees. However, it can be noted that simulation based solar irradiances result in distinctively different values for each rotation angles whereas the regression model based irradiances are estimated with relatively less distinctive values.

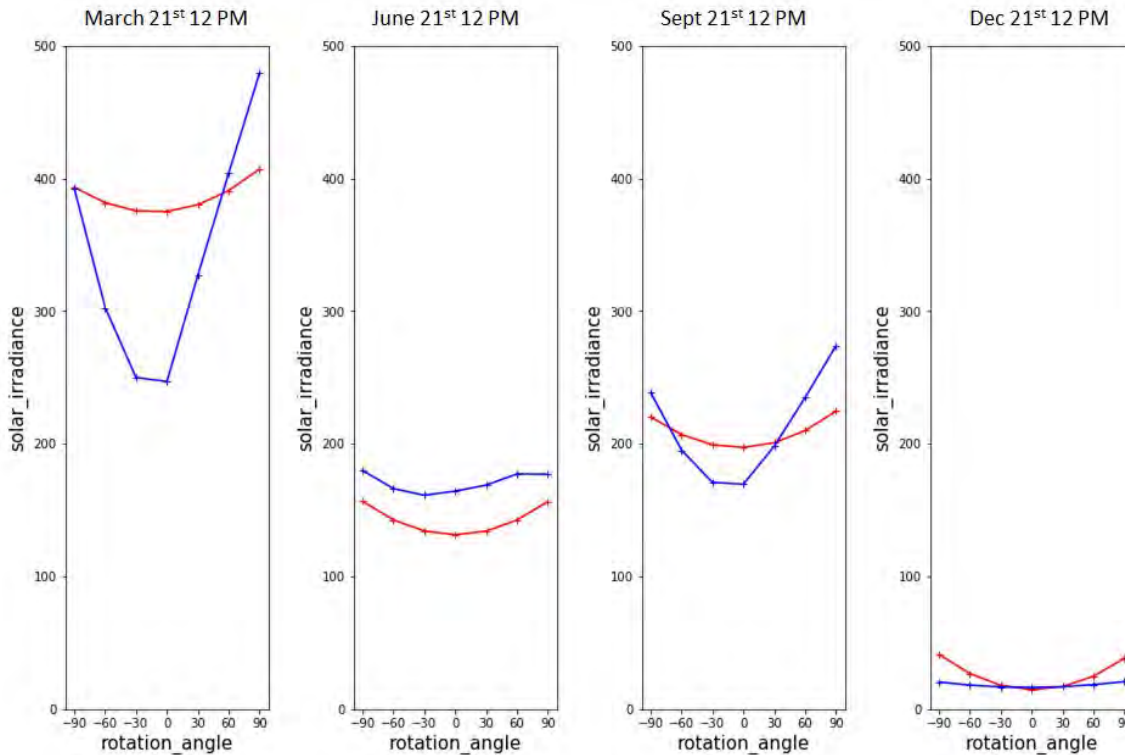


Figure 5: Comparison between the solar irradiance by the regression model and the simulation (Author, 2021)  
 Note. Solar irradiance value by the simulation (Blue) / Solar irradiance value using regression model (Red)

In order to understand the residuals between the regression model and the simulation result, the proposed methodology was approached with two aspects: time ranges for data collection and regression coefficient. For the time range of data collection, the regression model developed in this research took into consideration of an entire year of solar irradiance as the rotation angle of the kinetic façade changed. Therefore, it is difficult to correctly predict a solar irradiance value at a specific point in time. The following approach can be considered to reduce the discrepancy between the predicted value by the regression model and the simulation results. When the multiple regression models are developed by dividing the sun's trajectory into several zones in consideration of season and time, its accuracy has been increased and the predicted value by the regression model has been closely in line with the simulation results. In addition, the regression coefficient value of the rotation angle is smaller than other independent variables such as altitude, azimuth, and solar intensity. The regression coefficient value of the independent variable means the effect on the dependent variable. When a value of the regression coefficient of an independent value is small, the predicted value influenced by the independent variable is also small. Therefore, the solar irradiance variation by the rotation angle in the regression model is small compared to the simulation result. In this case, this problem can be fixed by increasing the influence of the rotation angle by individually determining the order of each independent variable. In this research, all independent variables were transformed into a quadratic form. After analyzing the data distribution between the dependent variable, solar irradiance, and each independent variable, the order of each independent variable can be decided. In this approach, the difference between the regression model and the simulation result can be reduced.

#### 4.0 CONCLUSION

This research suggested an approximation methodology for predicting the performance of a kinetic facade system using a regression model. Since the kinetic facade system developed in this research has rotational motions according to the sun's movement, it needs to consider various kinetic motions in the process of developing regression model. Therefore, this research developed a quadratic regression model to make a better prediction accuracy by analyzing the solar performance of the rotational motion. Overall, the developed regression model has a good R-squared value

with 94%, which can estimate solar performance and best rotational angles of the kinetic façade system. However, it is required to improve the prediction accuracy of the regression model which is focusing on the rotation angle. Therefore, additional studies will be conducted to develop a regression model that increase the influence of the rotation angle by changing the order of rotation angle and grouping the data with similar conditions. For future study, annual sun path diagrams can be divided into multiple zones. Then a regression model per each sun path zone will be developed to respond sensitively to the changes of independent variables. Through this process, the accuracy of regression models can be increased and it can contribute to reducing a time consuming simulation process for the efficient performance evaluation of a kinetic façade system.

## REFERENCES

- Alotaibi, Fahad. "The role of kinetic envelopes to improve energy performance in buildings." *J Archit Eng Tech* 4, no. 149 (2015): 2.
- Asadi, Somayeh, Shideh Shams Amiri, and Mohammad Mottahedi. "On the development of multi-linear regression analysis to assess energy consumption in the early stages of building design." *Energy and Buildings* 85 (2014): 246-255.
- Chi, Doris A., David Moreno, and Jaime Navarro. "Design optimisation of perforated solar façades in order to balance daylighting with thermal performance." *Building and Environment* 125 (2017): 383-400.
- Elghazi, Yomna, Ayman Wagdy, and Sahar Abdalwahab. "Simulation Driven Design for Kinetic system; Optimize Kaleidocycle Façade Configuration for Daylighting Adequacy in Hot Arid Climates." In *Conference of International Building Performance Simulation Association*, pp. 182-189. 2015.
- Im, O., K. Kim, and S. Han. "A Kinetic Light Shelf Unit as an Integrated Intelligent Control Device for Optimizing Interior Illumination." In *Proceedings of the Eighth International Multi-Conference on Computing in the Global Information Technology*, pp. 295-298. 2013.
- Korolija, Ivan, Yi Zhang, Ljiljana Marjanovic-Halburd, and Victor I. Hanby. "Regression models for predicting UK office building energy consumption from heating and cooling demands." *Energy and Buildings* 59 (2013): 214-227.
- Mahmoud, Ayman Hassaan Ahmed, and Yomna Elghazi. "Parametric-based designs for kinetic facades to optimize daylight performance: Comparing rotation and translation kinetic motion for hexagonal facade patterns." *Solar Energy* 126 (2016): 111-127.



# Building Enclosure and its Outdoor Thermal Behaviour: *In situ* Measurement Efficacy

Patricia N. Kio<sup>1</sup>, Ahmed K. Ali<sup>1</sup>

<sup>1</sup>Texas A&M University, College Station, TX

**ABSTRACT:** Combining two systems; living walls and double envelopes for building's enclosures are introduced to achieve energy conservation benefits and provide aesthetics in urban areas. Many studies tackled the effects of double walls on reducing energy and heat gain on buildings, but very few measured the effects of these enclosures on the urban microclimate. This paper demonstrates a methodological workflow for assessing the thermal performance of a novel living wall. Measurements were carried out at 16:00 hours for 31 days in August during Summer 2019 and at 14:00 hours for 44 days during Summer 2020. Meteorological conditions measured by a weather station in the same surrounding microclimate for August 2019 were considered as a reference for the thermal performance in the microclimate analysis. In 2020, irradiance was measured at surfaces *in situ* for microclimate analysis and their sky view factors were obtained to standardize exposure to the sun. Irradiance at surfaces showed differences in thermal performance and effectiveness of the geometry of modular living wall units/modules. Maximum irradiance of 595.3 W/m<sup>2</sup> occurred at the metal door. Average temperatures of the flat surface of the modules and flat metal door show that cooling effect improved from 4.6 °C in 2019 to 8.4 °C in 2020. Results of paired T-tests between both metal surfaces provided evidence of the effectiveness of module geometry on its irradiance. Thermal values were found to likely increase after applying sky view factor for similar conditions of sunlight at facades. This comparative analysis of the experimental results on a living/double wall and surfaces demonstrates the thermal behavior of a novel modular living/double wall and its potential to mitigate urban heat island in the surrounding microclimate.

**KEYWORDS:** Living walls, Double façade, Urban sustainability, Urban Microclimate, heat island effect.

## INTRODUCTION

Green walls are grown directly on building enclosure surfaces while living walls require a structure to support containers/modules before they are affixed to buildings. Living walls could be installed at exterior blank walls to reduce cooling loads, make the exterior surfaces aesthetically pleasing, and more attractive. The use of vegetation and green roofs in buildings are established cooling strategies (Manso and Castro-Gomes 2015) and living walls are becoming widespread (Pérez, Rincón et al. 2011).

Living walls require growing substrate, irrigation systems, pre-vegetated plants and supporting elements. There are two main types of living wall systems (LWS); continuous and modular (Vox, Blanco et al. 2018). In continuous LWS, planting is carried out on a vertical substrate without divisions. Modular systems are designed with either planters or panels (Charoenkit and Yiemwattana 2016). Development of living walls has been rapid, contributing immensely to the environment (Ottele, Perini et al. 2013). LWS provide greenery without using up valuable land in urban areas. Although LWS are the most expensive type of vertical greening system due to their supporting frame, maintenance and design complexity; they still remain desirable as they increase the variety of plants engaged and offer more creative and aesthetic potential (Lambertini 2007). Living walls have irrigation systems that are either single or multiple emitting units supplying water to plant modules.

Living wall interventions partition radiant energy supplied to a site. Their cooling especially on hot days is achieved through the joint operation of eight mechanisms, namely: (a) latent heat absorption due to evapotranspiration; (b) shading due to solar barrier of vegetation and module cover; (c) reflection of solar radiation due to increase in albedo of the living wall surface; (d) absorption of solar energy by photosynthesis, respiration and other plant functions; (e) reduced penetration of ambient warm air from reaching building external wall; (f) thermal insulation due to substrate installed on the wall; (g) thermal insulation due to stagnant air trapped in biomass structure; and (h) thermal insulation due to the cavity between the living wall and building wall (Jim 2015).

Existing research shows that living walls are suitable for green retrofits (Feng and Hewage 2014, Pulselli, Pulselli et al. 2014, Zhao, Zuo et al. 2019), but they have been regarded as luxury and viewed as a high cost element (Kharrufa and Adil 2012, Riley, de Larrard et al. 2019). Still and slower movement of air in cavities have a heat barrier function and suppress thermal conductance perpendicular to building wall face (Scarpa, Mazzali et al. 2014). Ambient air and mean radiant temperatures in front of living wall can also be lowered (Cameron, Taylor et al. 2014, Tan, Wong et al. 2014).

Solar energy dominates the cooling mechanisms which determine the thermal shielding effectiveness of green walls and living walls. Wall orientation and shading determine the solar-radiation regime.

Many studies overlook the contribution of the supporting materials of the planters to the success of the living green walls (Anđelković, Gvozdenac-Urošević et al. 2015, Alberto, Ramos et al. 2017); and living walls have not been fully approved as structures for energy saving due to the lack of availability of data on their efficiency and financial benefits (Ottele and Perini 2017, Zhao, Zuo et al. 2019). A review of scientific literature on green walls or facades on VGS also showed that many studies were prone to research design problems, lacked replication and provided insufficient information about the microclimatic parameters measured (Hunter, Williams et al. 2014). Living walls are not as durable as the buildings upon which they are installed, giving rise to high maintenance costs (Riley, de Larrard et al. 2019). The life expectancy of an indirect steel system is about 50 years (Dunnnett and Kingsbury 2004, Ottele, Perini et al. 2011, Perini and Rosasco 2013). And the replacement frequency for the plants in a living wall system is 10% replacement/year (Ottele, Perini et al. 2011).

Circular economy seeks to reuse materials keeping them in the loop and extending their life cycle. Investigations have been carried out using automotive industrial scrap metal for building enclosures (Ali, Wang et al. 2019, Ali, Kio et al. 2020). Architects and urban planners can lower costs of living walls by reusing industrial waste streams through circular economy for sourcing their primary materials. Circular economy uses a 9R framework list: refuse, rethink, reduce, reuse, repair, refurbish, remanufacture, repurpose, recycle and recover (Kirchherr, Reike et al. 2017). Steel is considered a circular material, and reusing steel extends its lifespan, contributes to stewardship and begins a new product phase due to its durability (Yellishetty, Mudd et al. 2011). The life expectancy of a living wall steel system is about 50 years (Dunnnett and Kingsbury 2004, Ottele, Perini et al. 2011, Perini and Rosasco 2013).

An experimental modular living wall was produced by reusing scrap metal from an automobile company. This study is the first of a three phased research and seeks to characterize the thermal performance of the MLW. This field experiment under humid-subtropical climatic conditions was designed to address the following research questions: (a) solar irradiance on the novel MLW during summer days; and (b) thermal performance of MLW, building and vegetation surfaces in their surrounding microclimate. A measurement campaign was carried out for two summers and collected data were analyzed for solar irradiance and thermal performance. A paired sample t-test showed the effectiveness of the geometry of the metal modules when mean temperatures at flat surfaces were compared to those at the metal door.

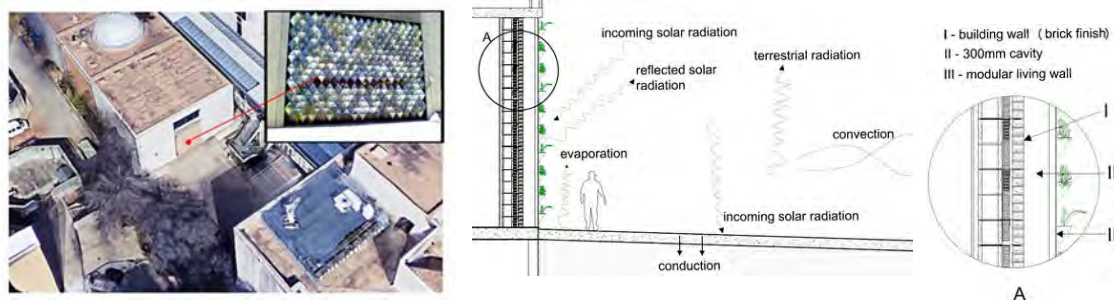
## **1.0 STUDY AREA AND METHODS**

### **1.1 Study area**

The humid sub-tropical climate is characterized by hot and humid summers. From the National Weather Service in the United States, the hottest months are July, August and September with recorded highs of 43.3 °C, 42.8 °C and 44.4 °C. The highest relative humidity was from 84% to 92%, and average wind speed 7.2m/s. The average daily incident shortwave solar energy ranged from 6.5 kWh to 5.7 kWh over the month of August. The extremes, normal and annual summaries indicate global warming and urban heat island effect as high temperature records are tied and broken and recent low temperatures are usually higher than old ones.

### **1.2. Experimental plot and modular living wall**

The novel modular living wall (MLW) is 5.8 metres wide by 4.3 metres high, and was installed on the south-east facing wall of an institutional building (Fig. 1) at a 27 by 24 metre courtyard. A supporting metal frame carried approximately 300 diamond-shaped modules creating a cavity behind the MLW. Multiple emitter irrigation system which supplies water to each module's engineered soil. Plants grow upwards with sufficient space for heightened species; they were positioned and grouped to achieve variety; thorny plants were placed higher. Their water requirements ranged from dry to medium as one of the goals was to discover the plants that could survive in extreme environment and low maintenance (Ali and Dvorak 2019). The MLW and control surfaces constituted 7 experimental areas (MLW, concrete wall (CW), metal door (MD), shaded brick wall (SBW), bare brick wall (BBW).



**Figure 1:** Study site, flows of energy towards and away from the study site; detail of building enclosure, cavity, and modular living wall. Source: (Authors 2021) flows of energy adapted from Brown and Gillespie, 1995

### 1.2.1 Substrate

Each module had a depth of 215mm for soil. Two types of soil were used a growing media on top and drainage layer below. The growing media was Rooflite Extensive 700 Growing Media and the drainage layer was Rooflite Drain 600 Drainage Layer.

### 1.2.2 Container Module

Galvanized sheet scrap metal from an automobile industry, was reused as raw material for the 300 diamond shaped modules. Each module was 305mm wide, 230mm wide and 455mm high. Modules have three surfaces, flat, left and right, Fig. 2. The left and right faces were at an angle of 45 to the vertical and horizontal which could significantly change their exposure to solar incident rays.



**Figure 2:** Prototype of module in modular living wall showing geometry. Source: (Authors 2021) adapted from Brown and Gillespie, 1995

### 1.2.3 Cavity

The MLW created a 300mm cavity, (Figure 1) between itself and the building surface functioning as a double-skin façade. The cavity acts as a thermal insulation layer with the ability to control heat gains and losses (Perini and Rosasco 2016).

### 1.2.4 Water Nutrient

The frequency and rate of flow determines the length of time the soil remains wet. Each module had one emitter supplying water. Drop irrigation for both years was 1.16 gal/week with excess drainage flowing behind modules.

### 1.2.5 Vegetation

Native plants such as *Dichondria argentea*, *Agave lophantha*, *Hesper aloe parviflora*, *yucca flaccida* and *hechtia texensis* plants were chosen and designed considering their low water requirements.

### 1.2.6 Maintenance

Most benefits of green facades have been estimated and not quantified since the 1980s; this study provides specific characteristics of its system for life cycle analysis research comparing this novel living wall with other living walls for environmental burden and economic sustainability (Ottele, Perini et al. 2011). Frequency of maintenance activities include, watering once daily, weeding and replanting by ladder.

## 1.3. Environmental monitoring setup

In August 2019, a FLIR E6 thermal imaging camera, Kestrel 5400 heat stress tracker measured surface temperatures, air temperatures, and relative humidity. Data from site weather station indicated conditions at the study site. In 2020, additional instruments used included a solar meter, Davis leaf/soil weather station with four temperature probes and a leaf wetness and temperature sensor for irradiance and surface temperature measurements of soil, leaf and control bare brick wall. Data for 44 summer days in 2020 at 2:00pm daily were recorded. Spot measurement and equipment positions are shown in Fig. 3 and Fig. 4.



Microclimatic parameters were measured at the plots using equipment in Fig. 5 for air temperature and relative humidity at site, modular living wall, courtyard, cavity, bare and shaded brick walls. Surface temperatures of modular living wall, concrete wall, bare and shaded brick walls and metal door. Solar irradiance was measured at modules, concrete wall, shaded and bare brick walls.

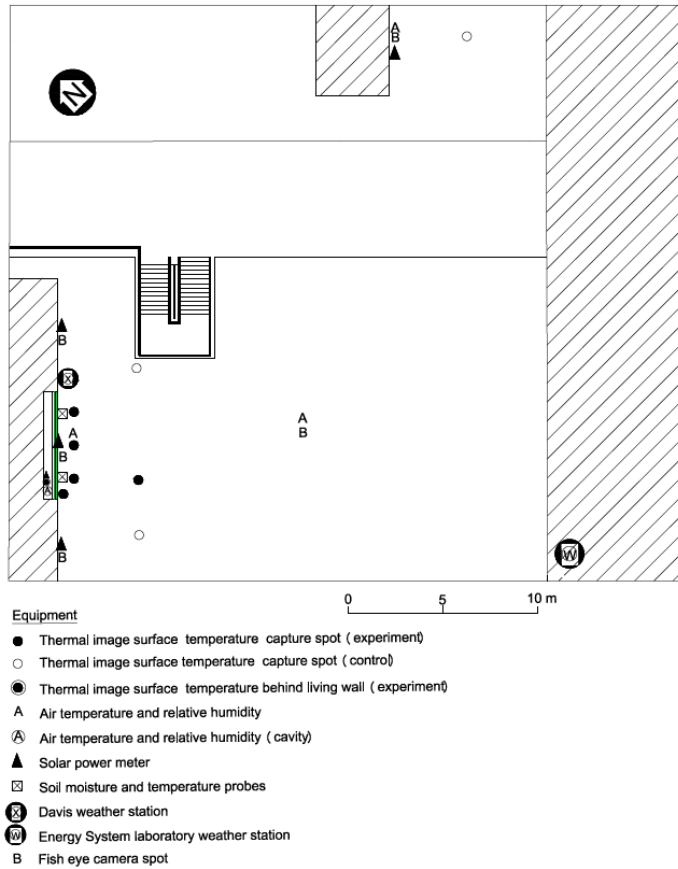


Figure 3: Equipment were used to obtain spot measurements. Source: (Authors 2021)

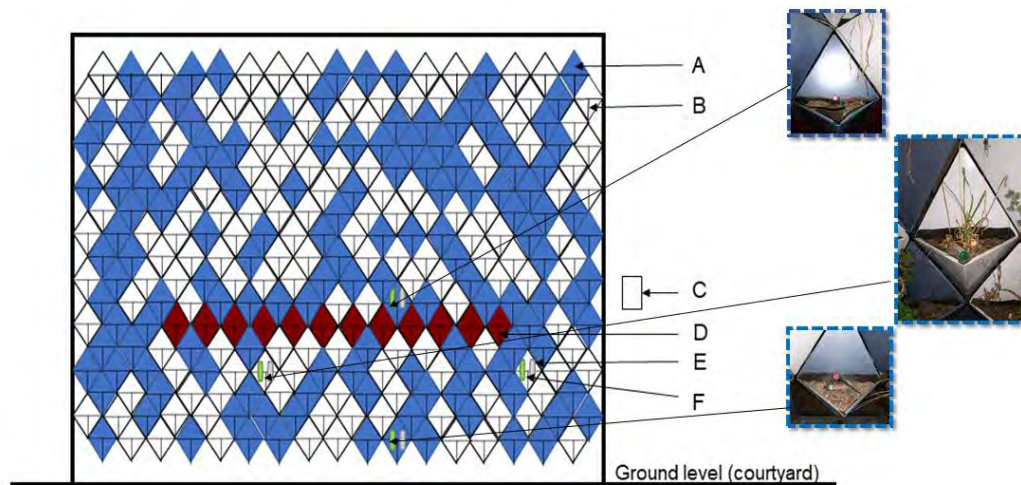
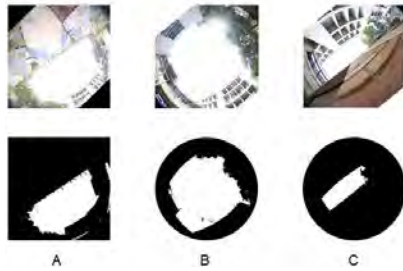


Figure 4: Modular living wall showing positions of weather station and temperature and moisture probes. (A- Blue modules, B- White module, C- Davis Weather station, D- Maroon module, E- soil temperature probe, F- moisture probe). Source: (Authors 2021)

The SVF is the amount of area exposed to the sky, where 0 means total cover and 1 means an open area like a field. The sky view factor is the fraction of the visible sky, seen from a certain point (Oke 2002). Hemispherical images from a Canon EOS 6D fisheye camera in Figure 5 were used to derive SVF at the site and surfaces. Fisheye images were analyzed using RaymanPro software and the SVF at MLW is 0.32, centre of courtyard is 0.52, bare brick wall is 0.12 and concrete wall 0.39, Fig. 6.



**Figure 5:** Equipment for measurement campaign for 2019 and 2020. 1-FLIR E6 thermal imaging camera, 2- Kestrel 2400 Heat Stress Tracker, 3 – Solar Meter, 4- Canon EOS fisheye camera, 5- Davis weather station, 6- Davis Vantage Pro 2, 7 – soil moisture and temperature probes, 8 – leaf temperature and wetness sensor. Source: (Authors 2021)



**Figure 6:** Sky view factor of modular living wall (A) – 0.32, courtyard (B) – 0.51, and bare brick wall (C) – 0.12. Source: (Authors 2021)

## 2.0. RESULTS AND DISCUSSION

### 2.1. Solar irradiance modular living wall and microclimate

Solar radiation incident at MLW has important bearing on the temperature and vegetation growth. The site weather station recorded a range of 121 – 571 Wm<sup>-2</sup> in August 2019. The energy given off by the surfaces of the modules is related to their temperature. Austrian physicists, Stephan and Boltzmann stated that energy-temperature relationships should obey the following law in eqn. (1), when temperature is in Celsius degrees:

$$Energy = S \times (T + 273)^4 \quad (1)$$

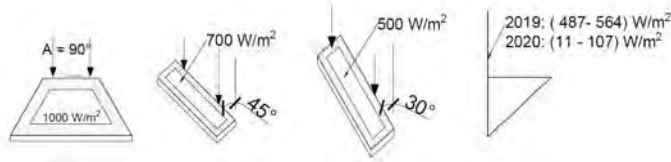
Where S = 5.670 x 10<sup>-8</sup> W/m<sup>2</sup>K<sup>4</sup> (Boltzmann constant) (Brown and Gillespie 1995, English 1999). Stephan-Boltzmann equation was used to calculate the energy emitted by unmeasured surfaces in watts per square meter. Applying this equation to surface temperatures in 2019. The range of solar radiation at MLW was 493.2 – 561.8 Wm<sup>-2</sup>, SBW; 314.9 – 522.9 Wm<sup>-2</sup>; concrete wall (CW), 502.4 – 558.3 Wm<sup>-2</sup>; MD, 314.9 – 595.3 Wm<sup>-2</sup>. Maximum solar radiation at MLW was lower than that at weather station and the maximum solar radiation in the environment was recorded at metal door. In 2020, there was no data from weather station at site due to construction activities. Data for 45 days using solar metre at 14:00hrs daily in summer 2020 recorded solar radiation ranges at MLW module surfaces to be 11 -148 W/m<sup>2</sup>; 1.6 – 21 W/m<sup>2</sup> at SBW, 45 - 224 W/m<sup>2</sup> at CW; and 21 – 129 W/m<sup>2</sup> at bare brick wall (BBW). From Fig. 7, the least solar radiation is at the shaded brick wall (SBW); then modules left at 148 W/m<sup>2</sup>, right at 18 – 123 W/m<sup>2</sup> and flat surfaces at 11 – 107 W/m<sup>2</sup> of the modules. The highest solar radiation was recorded at CW.

#### 2.1.1 Solar irradiance substrate

Substrate measurement in 2020 was recorded with FLIR tools and Davis leaf/soil temperature probes. Data for 20 days show that solar radiation at soil was within the range of 499.8 – 590.5 W/m<sup>2</sup> from FLIR and 461 – 552.8 W/m<sup>2</sup>.

### 2.1.2 Solar irradiance at modules

The geometry of the modules determines the incident angle which is a key determinant of solar energy reception. In 2019, the ranges at the flat, left and right surfaces are 486.8 – 564.2 W/m<sup>2</sup>, 544 – 575.4 W/m<sup>2</sup>, and 536.8 – 573.2 W/m<sup>2</sup> consecutively. In 2020, the ranges at flat surfaces were 11 – 107 W/m<sup>2</sup>, left 17 – 148 W/m<sup>2</sup>, and right 18 – 123 W/m<sup>2</sup>, Figure 7.



**Figure 7:** Solar irradiance at surfaces and module. Source: (Authors 2021) adapted from Brown and Gillespie, 1995

### 2.1.3 Solar irradiance vegetation

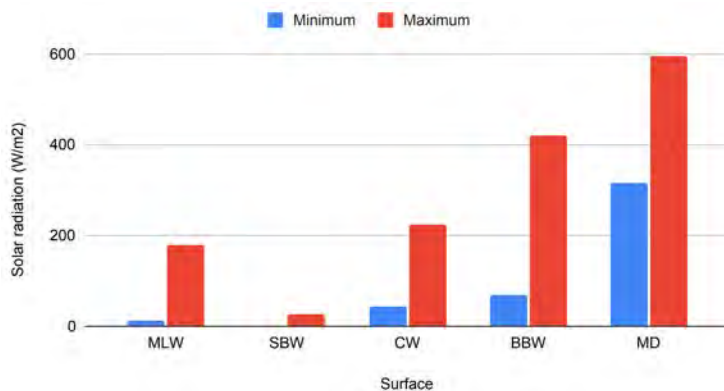
In 2019, solar radiation at leaves was 497 – 562 W/m<sup>2</sup>. In 2020, FLIR thermal images resulted in 487.3 – 556.3 W/m<sup>2</sup> and Davis leaf temperature and wetness, 461 – 548.6 W/m<sup>2</sup>

### 2.1.4 Applying sky view factor

After SVF is applied, solar radiation at MLW remains lower than CW, the condition at BBW is hottest as it is situated in a narrow open area (Table 1) and Fig. 8.

**Table 1:** Surfaces and their sky view factors in 2020. MLW – modular living wall, SBW – shaded brick wall, CW – concrete wall, BBW – bare brick wall, MD – metal door. Source: (Authors 2021)

	MLW	SBW	CW	BBW	MD
Sky view factor	0.32	0.32	0.39	0.12	0.39
Solar radiation (Wm <sup>-2</sup> )	11 - 148	1.6 – 21	45 - 224	21 - 129	314.9 – 595.3
Actual radiation (Wm <sup>-2</sup> )	13.4 – 180	1.9 – 25.62	45 - 224	68.25 – 419.3	314.9 – 595.3



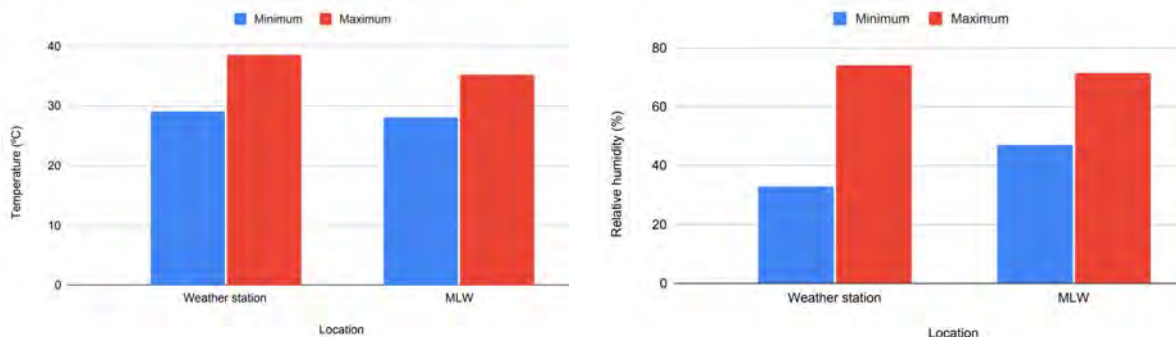
**Figure 8:** Solar irradiance at surfaces after applying sky view factor. Source: (Authors 2021)

## 2.2. Thermal performance at modular living wall and microclimate

Air temperature at site weather station was 29 – 38.6 °C and at MLW was 28 – 35.2 °C; relative humidity at site weather station was 33 – 74% and at MLW it was 46.8% - 71.3%. Surface temperatures at MLW in 2019 was 33.8 – 42.5 °C, SBW: 32.7 – 36.9 °C, CW: 38 - 42 °C, and MD: 33.2 – 47.1 °C, Fig. 9. Cooling effect of MLW when compared to metal door is the difference in their temperature 4.6 °C.

In 2020, surface temperatures were MLW: 28.7 – 41.6 °C, SBW: 26.9 – 35.6 °C, CW: 28.5 – 42.9 °C, MD: 29 – 45.6 °C, and control BBW was 28.2 – 42.9 °C. Air temperature at MLW was 25.8 – 37.2 °C, BBW: 25.4 – 38.9 °C, cavity: 26 – 37.3 °C and at the centre of courtyard; 25.9 – 37.4 °C. Relative humidity at MLW was 42.3 – 82.9%, BBW: 39.5 – 85.7%, cavity: 37 – 84.4% and centre of courtyard; 38.1 – 84.7%. Cooling effect in 2020 between MLW and MD was 8.4 °C. Both surfaces had similar minimum temperatures in the two years.

Soil temperature in 2020 from FLIR tools was 32.2 – 45.2 °C; and 26.1 – 40 °C from Davis soil temperature probes. In 2019, temperatures at module surfaces were flat: 30.2 – 41.6 °C, left: 38.7 – 43.1 °C, and right 37.7 – 42.8 °C. 2020 results were flat: 31.4 – 40.2 °C, left: 32.1 – 43.9 °C, and right: 32.2 – 43.7 °C. Surface temperatures of leaves in 2019 were 31.8 – 41.3 °C, while in 2020 temperatures were 30.3 – 40.5 °C from FLIR tools and 26.1 – 39.4 °C from Davis leaf wetness sensor.



**Figure 9:** Comparison of temperature and relative humidity at site weather station and modular living wall in 2019. Source: (Authors 2021)

### 2.3 Paired sample T-Test between module and door

A paired sample t-test was carried out to ascertain the effectiveness of the geometry of modules to reduce surface temperatures by comparing the means of module flat surfaces to the mean surface temperatures at metal door. The null and alternate hypotheses are below in (2) and (3).

$$H_0: \geq 0 \quad (2)$$

$$H_a: < 0 \quad (3)$$

The calculated t value was -10.44 and fell into the rejection region of the actual t value of -1.7291. The confidence interval was (-3.3, -2.4), therefore there was sufficient evidence to be 95% confident that the surface temperatures at the flat area of the modules were cooler than the metal door in the same microclimate. The temperature difference for this study was compared to those in other studies (Table 2).

**Table 2:** Temperature decrease for MLW and other living walls. Source: (Authors 2021)

Location	Temperature decrease	Articles
Current study	4.6 °C - 8.4 °C	(Authors, 2021)
Hong Kong	8.4 °C	(Alexandri and Jones 2008)
Tokyo	5.8 °C	(Shibuya, Soh et al. 2007)
Mediterranean	10.8 °C	(Eumorfopoulou and Kontoleon 2009)

## CONCLUSION

This paper demonstrated a methodological workflow for assessing the thermal performance of a novel living wall during two summer-weather scenarios in a humid-subtropical climate. The experimental approach resulted in rich data to assess temperature regimes.

This study addressed the research question of how changing the geometry of the modules affected its temperature reduction potential. At the experimental site, shading with MLW generated the most cooling effect on the shaded brick building surface. It is notable that the shaded brick wall is consistently cooler than the benchmark concrete, bare brick surfaces and metal door during the two summers. This phenomenon indicates that the cooled brick surface behind transmits less heat into the indoor air lying behind the wall and the MLW surface is cooler than the concrete wall, bare brick wall and metal door. Cooling effect resulting from comparison between metal module flat surface and metal door improved from 4.6 °C in 2019 to 8.4 °C in 2020. In addition, paired t-test of average surface temperatures between the surfaces provided evidence that the geometry of MLW modules reduces surface temperatures at the flat module surface as leaf temperatures were almost the same as module temperatures. The application of these circular economy sourced modules combined with designed geometry could change public perception of reusing waste as building elements and increase acceptance of reusing waste materials in the society.

Future studies include analysis of *insitu* measurements during the three other seasons for annual module thermal performance; exploration of more module geometries; address the impact of the MLW on the building's interior

temperature; focus on how evapotranspiration of the MLW could reduce urban ambient temperatures and building surface temperatures; and plants will be studied for their effects on CO<sub>2</sub>.

## ACKNOWLEDGEMENTS

The authors would like to thank the Resource Based Design Research Laboratory at Texas A&M University which designed and installed the modular living wall. This work was supported by the College of architecture and General Motors Corporation.

## REFERENCES

- Alberto, A., N. M. M. Ramos and R. M. S. F. Almeida (2017). "Parametric study of double-skin facades performance in mild climate countries." *Journal of Building Engineering* **12**: 87-98.
- Alexandri, E. and P. Jones (2008). "Temperature decreases in an urban canyon due to green walls and green roofs in diverse climates." *Building and Environment* **43**(4): 480-493.
- Ali, A. and B. Dvorak (2019). *Cultivating research*. ARCC Conference Repository.
- Ali, A. K., P. N. Kio, J. Alvarado and Y. Wang (2020). "Symbiotic Circularity in Buildings: An Alternative Path for Valorizing Sheet Metal Waste Stream as Metal Building Facades." *Waste and Biomass Valorization*: 1-19.
- Ali, A. K., Y. Wang and J. L. Alvarado (2019). "Facilitating industrial symbiosis to achieve circular economy using value-added by design: A case study in transforming the automobile industry sheet metal waste-flow into Voronoi facade systems." *Journal of Cleaner Production*.
- Anđelković, A. S., B. Gvozdenac-Urošević, M. Kljajić and M. G. Ignjatović (2015). "Experimental research of the thermal characteristics of a multi-storey naturally ventilated double skin façade." *Energy and Buildings* **86**: 766-781.
- Brown, R. D. and T. J. Gillespie (1995). *Microclimatic landscape design: creating thermal comfort and energy efficiency*, Wiley.
- Cameron, R. W. F., J. E. Taylor and M. R. Emmett (2014). "What's 'cool' in the world of green façades? How plant choice influences the cooling properties of green walls." *Building and Environment* **73**: 198-207.
- Charoenkit, S. and S. Yiemwattana (2016). "Living walls and their contribution to improved thermal comfort and carbon emission reduction: A review." *Building and Environment* **105**: 82-94.
- Dunnett, N. and N. Kingsbury (2004). *Planting green roofs and living walls*. Nigel Dunnett and Noël Kingsbury, Portland, Or. : Timber Press, 2004.
- English, S. (1999). "Stephan Boltzmann Law and Boltzmann's Constant." *Wooster Physics Junior Theses*.
- Eumorfopoulou, E. and K. Kontoleon (2009). "Experimental approach to the contribution of plant-covered walls to the thermal behaviour of building envelopes." *Building and Environment* **44**(5): 1024-1038.
- Feng, H. and K. Hewage (2014). "Energy saving performance of green vegetation on LEED certified buildings." *Energy and Buildings* **75**: 281-289.
- Hunter, A. M., N. S. G. Williams, J. P. Rayner, L. Aye, D. Hes and S. J. Livesley (2014). "Quantifying the thermal performance of green façades: A critical review." *Ecological Engineering* **63**: 102-113.
- Jim, C.Y. (2015). "Thermal performance of climber greenwalls: Effects of solar irradiance + orientation." *Applied Energy* **154**: 631-643.
- Kharrufa, S. N. and Y. Adil (2012). "Upgrading the building envelope to reduce cooling loads." *Energy and Buildings* **55**: 389-396.
- Kirchherr, J., D. Reike and M. Hekkert (2017). "Conceptualizing the circular economy: An analysis of 114 definitions." *Resources, Conservation and Recycling* **127**: 221-232.
- Lambertini, A. (2007). *Giardini in verticale*, Verba Volant.
- Manso, M. and J. Castro-Gomes (2015). "Green wall systems: A review of their characteristics." *Renewable and Sustainable Energy Reviews* **41**: 863-871.
- Oke, T. R. (2002). *Boundary layer climates*, Routledge.
- Ottele, M. and K. Perini (2017). "Comparative experimental approach to investigate the thermal behaviour of vertical greened facades of buildings." *Ecological Engineering* **108**: 152-161.
- Ottele, M., K. Perini, A. L. A. Fraaij, E. M. Haas and R. Raiteri (2011). "Comparative life cycle analysis for green facades and living wall systems." *Energy and Buildings* **43**(12): 3419-3429.
- Ottele, M., K. Perini and E. M. Haas (2013). Life cycle assessment (LCA) of green facades and living wall systems, Elsevier: 457-483.
- Pérez, G., L. Rincón, A. Vila, J. M. González and L. F. Cabeza (2011). "Green vertical systems for buildings as passive systems for energy savings." *Applied Energy* **88**(12): 4854-4859.
- Perini, K., P. Rosasco (2013). "Cost-benefit analysis for green façades and living wall systems." *Building and Environment* **70**: 110-121.
- Perini, K. and P. Rosasco (2016). "Is greening the building envelope economically sustainable? An analysis to evaluate the advantages of economy of scope of vertical greening systems and green roofs." *Urban Forestry & Urban Greening* **20**: 328-337.
- Pulselli, R. M., F. M. Pulselli, U. Mazzali, F. Peron and S. Bastianoni (2014). "Emergy based evaluation of environmental performances of Living Wall and Grass Wall systems." *Energy and Buildings* **73**: 200-211.
- Riley, B., F. de Larrard, V. Malecot, I. Dubois-Brugger, H. Lequay and G. Lecomte (2019). "Living concrete: Democratizing living walls." *Science of the Total Environment* **673**: 281-295.
- Scarpa, M., U. Mazzali and F. Peron (2014). "Modeling the energy performance of living walls: Validation against field measurements in temperate climate." *Energy and Buildings* **79**: 155-163.
- Shibuya, K., Y. Soh and S. Satoh (2007). "Block survey of wall covered with plant in the city of Tokyo [Japan] and evaluation of thermal environment of wall greening system." *Bulletin of Tokyo Metropolitan Agriculture and Forestry Research Center (Japan)*.
- Tan, C. L., N. H. Wong and S. K. Jusuf (2014). "Effects of vertical greenery on mean radiant temperature in the tropical urban environment." *Landscape and Urban Planning* **127**: 52-64.
- Vox, G., I. Blanco and E. Schettini (2018). "Green façades to control wall surface temperature in buildings." *Building and Environment* **129**: 154-166.
- Yellishetty, M., G. M. Mudd, P. G. Ranjith and A. Tharumarajah (2011). "Environmental life-cycle comparisons of steel production and recycling: sustainability issues, problems and prospects." *Environmental Science & Policy* **14**(6): 650-663.
- Zhao, X., J. Zuo, G. Wu and C. Huang (2019). "A bibliometric review of green building research 2000–2016." *Architectural Science Review* **62**(1): 74-88.

# Facade Performance Study of a Historically Significant Brutalist Building: Thermal and Moisture Analysis

Suncica Milosevic<sup>1</sup>, Ajla Aksamija<sup>1</sup>

<sup>1</sup>University of Massachusetts, Amherst, MA

**ABSTRACT:** Preservation of historically significant buildings is essential to sustaining cultural heritage and history, but current preservation processes for such structures do not require stringent energy performance criteria. As a result, little research has been done on quantifiable methods for sustainable historic preservation, while striving to maintain the building's original design integrity. This paper presents a case study on facade performance for *Spomen Dom* (translating to "Remembrance Home"), a Brutalist civic building located in Montenegro, once part of the former Yugoslavia. This research was conducted to determine and analyze the building's original design features, to assess the building's current physical state and to investigate thermal/moisture performance of the building skin. The purpose was to evaluate building's current performance compared to original design intent, and to propose renovation strategies that would improve the building's performance, while striving to maintain the integrity of original design of the exterior enclosure. Though a single case study, methodology presented here can be widely applied to analyze performance and encourage sustainable retrofitting of historically significant buildings.

**KEYWORDS:** historical preservation, brutalism, retrofit, building performance, energy efficiency

## 1.0 INTRODUCTION

### 1.1. Current State of Architectural Retrofitting

Historically significant buildings have distinctive physical and spatial qualities that manifest architectural and historic value, improve our understanding of the past, and typically demonstrate exemplary design techniques associated with a certain architectural style or historic period (Aksamija 2021). They must meet criteria such as being of sufficient age (more than 50 years old), maintaining a relatively high degree of physical integrity (unchanged physical features), and demonstrating historical significance (Aksamija 2021). Architectural historic preservation is defined as the process of preserving and protecting historically significant buildings, with the primary goal of maintaining the original design intent, such as unique architectural features and materials (Aksamija 2021). However, current historic preservation process does not have to meet minimum energy performance criteria in the United States (U.S. DOE). Likewise, little research has been done on sustainable methods for historic preservation, such as quantifying the present state thermal and moisture performance and utilizing that information to inform delicate retrofit strategies that can improve performance of these buildings while maintaining their original design intent.

Given that buildings are the largest energy consumers in the world, global greenhouse gas emissions from existing stock of buildings must be reduced by 80-90% by the year 2050 (Bazaz et al. 2018). Reusing and retrofitting historically significant buildings, as opposed to demolishing them and building new buildings, is not only more environmentally sustainable (Aksamija 2017), but ethically essential for preserving cultural heritage. Sustainably performing retrofits can ensure long-term energy performance, and improve occupant comfort, health, and general sense of well-being (Tobias et al. 2009). Additionally, new building construction requires a higher quantity of new materials, while retrofitted buildings conserve the embodied energy of the original structure, diverging from the potential demolition and construction waste from landfills when buildings are demolished (Aksamija 2017).

### 1.2. Historical Context and Significance

Geometrically stark and materially pure, the Memorial and Cultural Center, also named *Spomen Dom* (literal translation "Remembrance Home"), is one of the few remaining Brutalist civic buildings in Montenegro. It was built between 1971 and 1975 in the small town of Kolasin, designed by a renown Slovenian architect Marko Mušič. It was originally designed as a cultural center and a WWII memorial. Its aim was to commemorate Yugoslavia's victory over fascism and Nazism, and to celebrate, inspire and promote collective participation in its wide-ranging and ideologically reinforcing building program (Kulic et al. 2012). *Spomen Dom* holds significant historical value due to its expressive, unique style, its relationship to the physical and cultural context of the region, and its ascribed political ideology.



Conceptualization of this unusual building with multiple civic and administrative programs was a result of the revolutionary political and economic movements of its time. The formation of the Socialist Federal Republic of Yugoslavia was a result of the royal kingdom's dissolution and the region's liberation from the axis powers during World War II by the socialist revolutionaries, or the partisans who fought two wars simultaneously – one to overturn the royal autocracy and another against the foreign fascist occupiers. This new political ideology needed to rebuild the destructed infrastructure, commemorate thousands of significant battle sites and grave sites, while it also needed to rebuild morale, inspire, celebrate, strengthen its utopian ideology and promote collective participation (Kulic 2018). This was done by ambitious federation-wide building of thousands of commemorative and cultural centers with extensive programs to both memorialize the casualties of war while also celebrating the socialist party's victory and its political ideology.

These ambitious and stylistically explorative movements in architecture, however, abruptly ended with both the collapse of the socialist federation in 1990 and Yugoslavia's subsequent, destructive civil war. Today, many of these unique, stylistically bold, and historically significant structures of various typologies are either systematically neglected, abandoned, in ruin, demolished, or repurposed with limited resources. Additionally, some examples face targeted destruction due to remaining ethnic tensions and interpretations of the symbolism these sites and buildings may carry. And, others, such as *Spomen Dom*, face potential demolition as their neglected state causes poor functionality and thermal performance, while their refurbishment is generally perceived as economically unfeasible compared to demolition and new construction.

### 1.3. Formal and Spatial Overview

Centrally set in a small city with population of about 3,000 people, and with its sheer size and alien form, *Spomen Dom* cannot go unnoticed (Fig. 1). It appears like a large abstract sculpture with prismatic geometries, which imitate the vernacular forms of this mountainous region, specifically traditional sloped residential roofs shaped in response to harsh winters but built with concrete instead of wood (Kosir 2010).



**Figure 1:** *Spomen Dom* photographs of current exterior state in summer conditions.

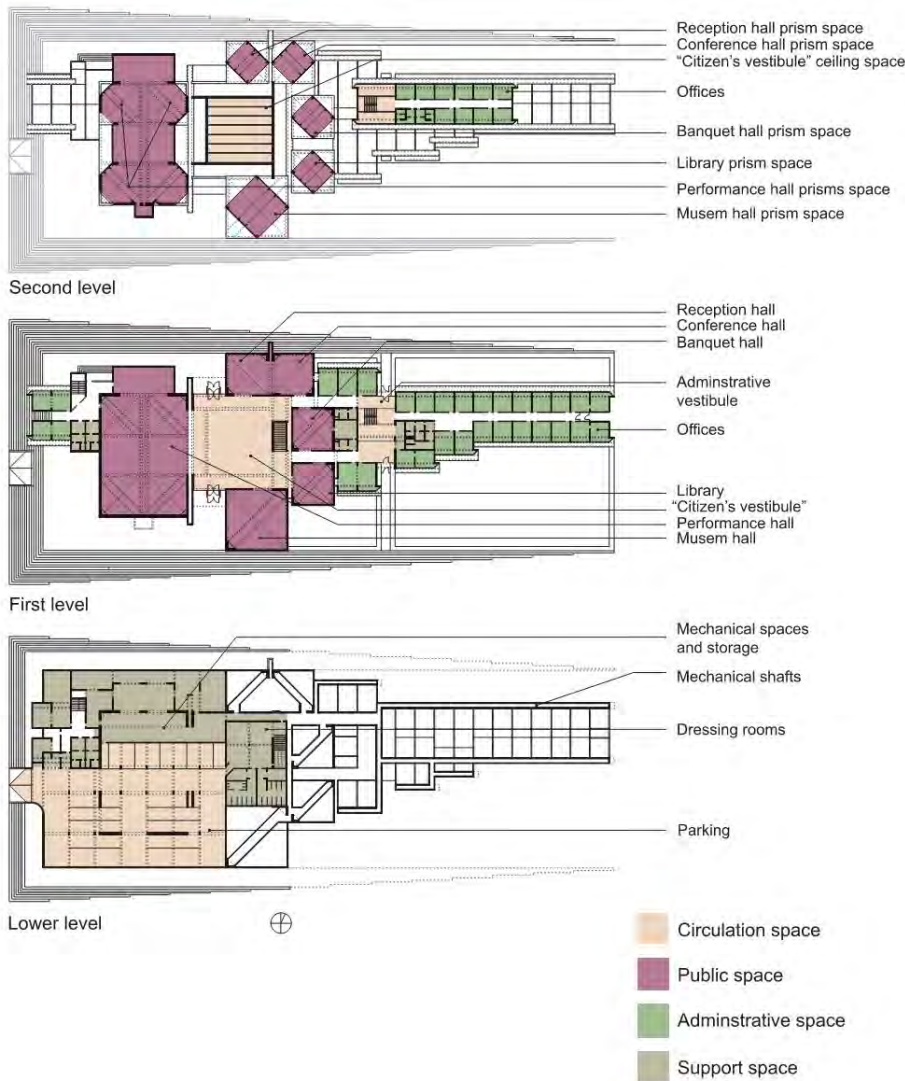
The building is characterized by its purely brutalist exterior, with folding, weathered, concrete prisms inset with deep-blue, tetrahedral skylight windows. Meanwhile, the exterior surprisingly contrasts with its kaleidoscopically colorful and retro finishes, fixtures, and furniture in the interior (Fig. 2). Kosir describes these volumes as pyramids and anti-pyramids, as a concept which is strongly rooted yet aims for skies, which may additionally speak of the intent to symbolizing a utopian goal that may be immortalized and fascinate the future generations (2010). He acknowledges that these concepts were strong enough to ignore the potential of these inverse slope windows being prone to rain penetration. By the architect himself, this formal play of roof geometries and stark contrasts with eclectically refined interior was described as the “world within a world, life within life, landscape in concrete” (Radevic, 1977).



**Figure 2:** *Spomen Dom* photographs of current interior state of formerly public venue spaces.

*Spomen Dom* is composed of three types of spaces: public halls, office spaces and technical support spaces organized around the central entrance vestibules, differentiated from each other by size, volume, and materials. The core

vestibule is the public entrance vestibule, titled *citizens' vestibule* surrounded by a wrath of public halls, formally expressed as tall concrete prisms. This central vestibule emulates a concept of a public square, and the flexibility of moveable partitions provide it with multi-functionality, flexibility, and fluidity (Radevic, 1977). The secondary and smaller entrance vestibule was intended to serve the building employees leading directly to their elongated, less formally playful, branch of private office spaces. The significance of the experiential relationship between the users and the sequence of these fluid spaces, in addition to relationships of building to its context, and building as a form of transmitted communication through time and cultural heritage is theorized by Stamatovic-Vuckovic and Kujundzic (2014) to assert



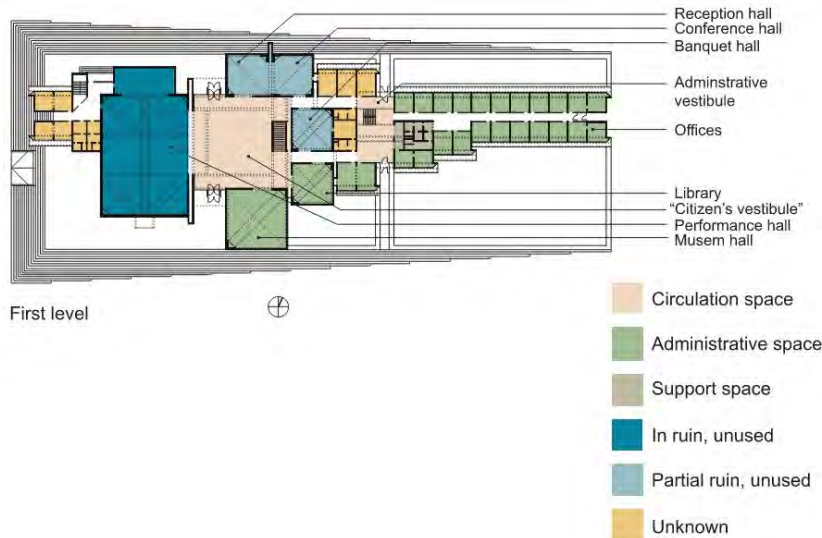
*Spomen Dom* as cultural heritage. Programmatic use of spaces, according to design intent (Fig. 3) differs from its adapted, current use, based on site visit documentation of Level 1 spaces, accounting for restricted access to some spaces (Fig. 4).

**Figure 3:** Floorplans of *Spomen Dom* according to original design intent and spatial organization.

#### 1.4. Present State

Presently, *Spomen Dom* is partially neglected, as a locked-up ruin, open to weather elements and partially in function as office space for municipal services (Fig. 4). The recent articles in local media protested this building as dramatically underperforming for its users (Scepanovic 2019 and 2020). Demolition and redevelopment of the project site were planned in the late 2000's due to building's poor performance and economically burdensome maintenance (Stamatovic-Vuckovic and Kujundzic 2014). Due to budgetary restraints, however, those plans were placed on hold. And, due to its decaying physical state, little effort has been made to preserve the building's existence, even though it is considered as one of the few remaining, exemplary buildings of the Brutalist architectural style in Montenegro.





**Figure 4:** Floorplan of *Spomen Dom*'s first level according to current use.

## 2.0 BACKGROUND AND RESEARCH OBJECTIVES

A literature summary relating to this building indicated that current studies that focus on analysis of its current state and performance do not exist, though some literature sources captured design features, historical context, theory, and historic significance of this building (Radevic 1977, Kosir 2010, Kulic et al. 2012, Stamatovic-Vuckovic and Kujundzic 2014, Niebyl 2018, Stamatovic-Vuckovic 2018, Stierli et al. 2018, Koselj 2018). Related to this geographic region, there are limited research publications on thermal performance and sustainability of buildings in general, especially existing buildings from this period. A single study of a historically significant building of this region, the Aviation Museum in Belgrade, was found (Todorovic et al. 2014). It analyzed moisture and thermal performance of its donut-shaped, fully glazed building envelope through thermographic testing and manual measurements of indoor air temperatures over different periods of the year. It also proposed strategies for its sustainable refurbishment through simulated energy analysis. Slightly related, though empirical, is a case study for a coastal, Adriatic climate zone for the city of Ulcinj (Bajcinovci, 2017), which analyzes potential for sustainable development through physical observations of local, passive design strategies for thermal comfort and natural ventilation. This geographic region does not have an established code on energy performance of existing buildings which makes quantitative studies difficult. Though few, these case studies indicate that this type of research and sustainable retrofit and development methods are gaining importance in Montenegro and its neighboring countries of the former Yugoslavia.

This research intended to analyze the building's original design features, to assess the building's current physical state, to conduct thermal/moisture performance analysis of the building skin, to evaluate building's current performance compared to original design intent, and to propose renovation strategies that would improve the building's performance while striving to maintain the integrity of original design of the exterior enclosure.

## 3.0 METHODS

Archival and observational research of original architect's documentation, construction drawings and published literature were used to analyze the original design intent, key architectural features, and to assess the building's current state and functions. Results of archival and observational research were used to current conditions and to develop a BIM model of *Spomen Dom*, using Revit software, to represent original spatial organization and the exterior shell. This model was used to evaluate building performance and the passive design strategies, such as response to solar radiation, shading, window-to-wall ratio, and building skin performance. Consequently, simulation software WUFI was used to analyze and quantify thermal and moisture performance of two typical facade systems – one at solid concrete assembly, and one at the angled prism assembly. These results were then compared against the ASHRAE energy performance requirements for this specific climatic region (ASHRAE 2017). Results were used to propose facade retrofit strategies that would meet high-performance criteria while maintaining the original design aesthetic on the building exterior.

## 4.0 RESULTS

The building's shape responds to solar orientation, as *Spomen Dom*'s north and south facades are elongated, while east and west are minimized. However, there are very few differences in facade treatment for different orientations and a relatively equal window-to-wall ratio between south and north facades is present. Additionally, the solid mass prisms with triangular windows also have similar exterior treatment and size of glazing, regardless of orientation. This indicated

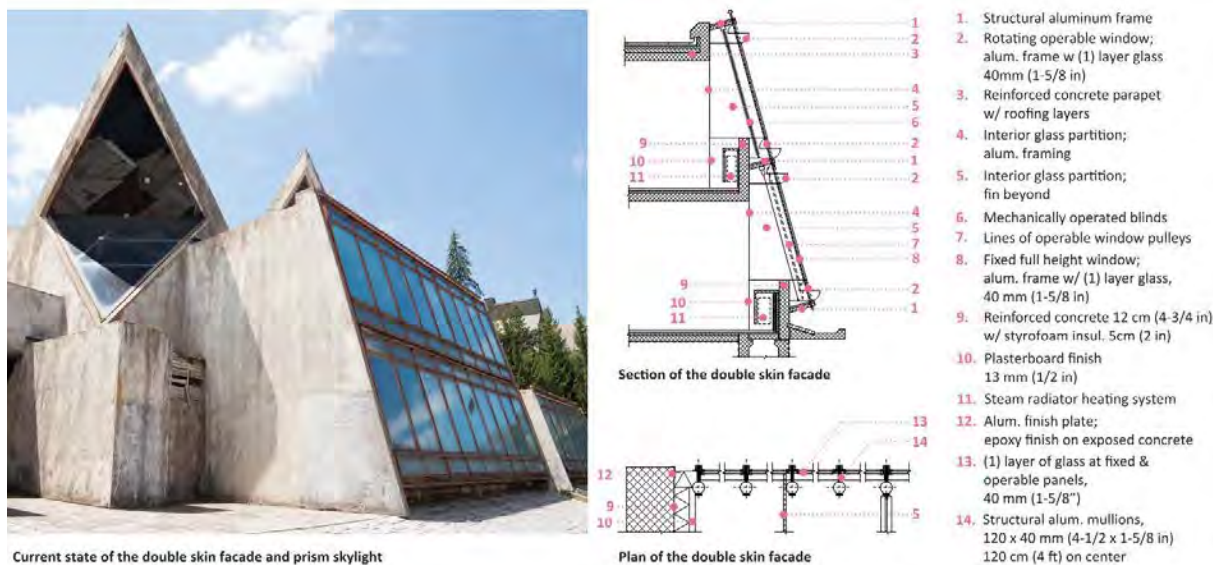
that passive strategies for solar exposure and radiation were not of primary concern. The BIM model was used to study shadows during different times of the year, and Insight 360 Solar Analysis software was used as a simulation tool to evaluate solar radiation (Fig. 5).



**Figure 5:** Solar radiation analysis of the *Spomen Dom* BIM model.

The north elevation is exposed to direct daylight in the early morning of the summer season, while during all other times it is in complete shade. Since the building is in a heating dominated climate where approximately eight months of the year require heating, the office spaces along that elevation likely feel very cold year-round and require significant heating to maintain a comfortable temperature in cold seasons. On the other hand, results for south elevation indicated that the administrative wings are facing direct sun at almost all times, and the only time that the offices are in shade is early morning in the summer. The solar radiation along this orientation is high – indicating the opposite, that the offices along this orientation may require significant cooling during the summer. Passive solar heating would be beneficial for this orientation in cold seasons.

A double skin glazed facade was designed along both south and north orientations, which was quite an advanced building technology at the time when *Spomen Dom* was built. The main advantage of double skin facades is improved thermal performance, and the approximated 0.8m (2.62 ft) cavity depth shown on the original drawings was a desirable depth for predominantly cold climates (Askamija, 2013). This double skin facade was to be vertical compartmentalized, spanning from the ground level to the roof, and included windows on the exterior side for ventilation, consisting of double-glazed units (Fig. 6). Since the air conditioning systems were not common at the time when the building was designed, these operable windows were intended to provide natural ventilation and cooling in the summer.



**Figure 6:** As designed and current state of *Spomen Dom*'s double skin facade of.

However, large discrepancies were observed between the original drawings and constructed facade (Fig. 7). Only the exterior layer of the double skin facade was constructed at all orientations of the building. Reasoning behind this omission is unknown. Thus, facade performance with a high window to wall ratio in this climate type without following design intent has been highly compromised. Additionally, the operable windows were drawn as 180-degree rotational

panels, but the actual installed windows only partially open at about 45 degrees. Also, the horizontal Venetian blinds deviances from construction documents have negatively impacted the performance of this otherwise technologically advanced passive system. Restoring this system per design intent and adapting it by utilizing double low-e glazing units on the exterior skin and adding the inside skin as single glazing units would greatly improve its performance. Additionally, installing a mechanical fan on the roof may help with air circulation and ventilation of the double skin cavity, as well as adding and renewing the shading devices in the cavity. Figure 7 also shows the extensive moisture penetration and building damage, which is accentuated during winter conditions.



Figure 7: Spomen Dom photographs of current exterior and interior state during winter conditions.

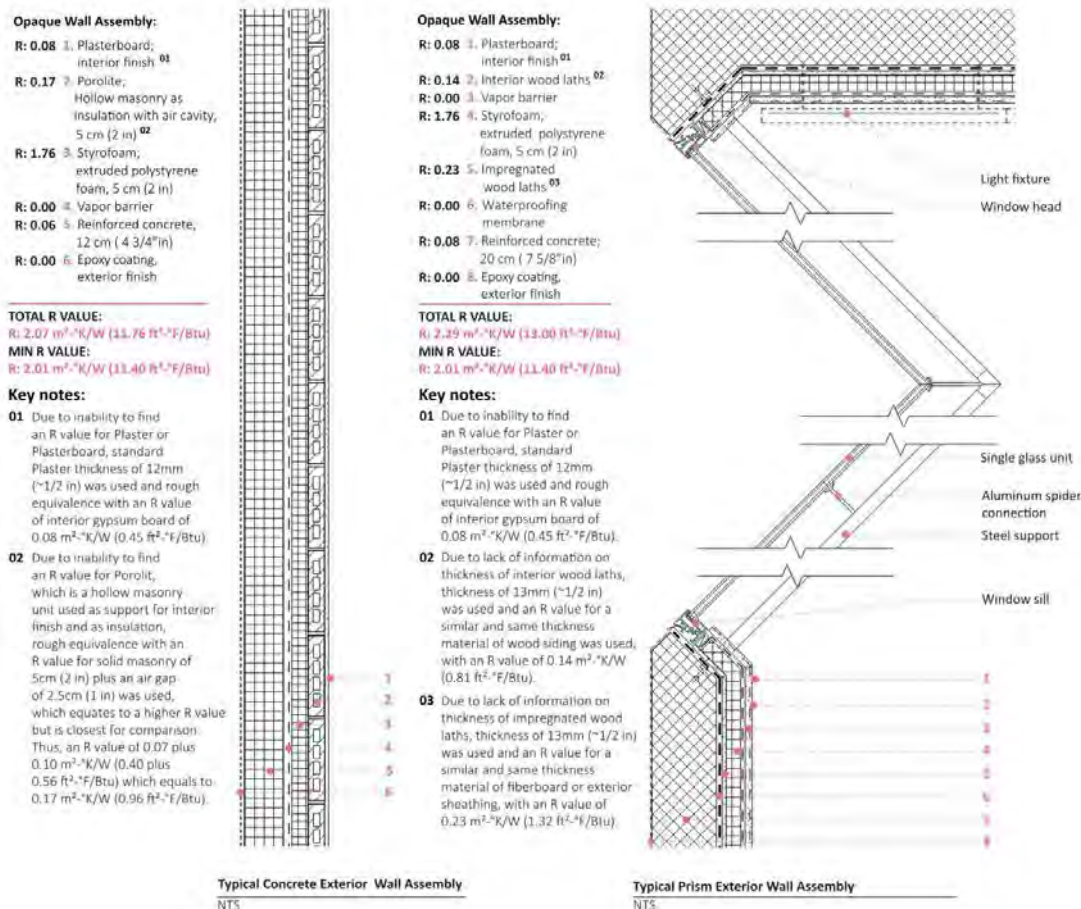
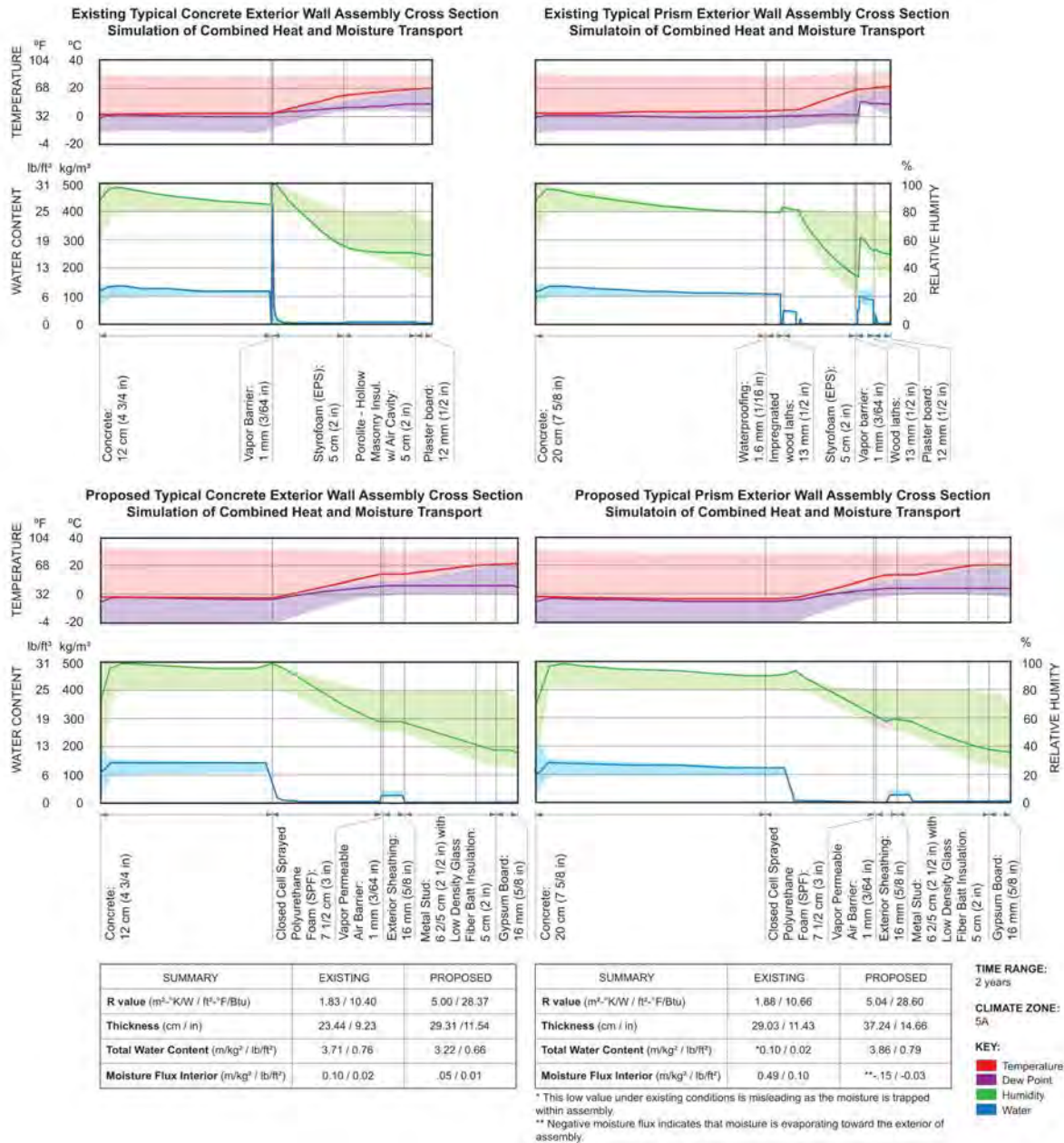


Figure 8: Thermal performance analysis of two selected exterior wall assemblies at Spomen Dom.

Simulations were performed to investigate combined heat and moisture transport at the opaque facades using WUFI software tool (Fig. 9), and at both tested assemblies significant moisture is retained on the building interior, likely due to a lack of an air cavity, insufficient insulation, material layers that are trapping vapor within the assembly (epoxy coating on the exterior surface of the concrete, waterproofing membrane and a vapor barrier between inside surface of concrete and insulation), and the porous nature of hollow masonry holding the interior plasterboard finish.





**Figure 9:** Thermal and moisture transfer analysis of two selected exterior wall assemblies at *Spomen Dom*.

Moisture retention is additionally critical at the typical prism exterior wall assembly, where the inward, pyramidal, single-layer glazing units force unusual and difficult to seal skylight/ window details (Fig. 8). Proposed wall assemblies indicate the most optimal results achieved after evaluating 26 options of interior wall layer combination studies, without any coatings or interventions at the exterior cast-in-place concrete layer. Due to significant concerns with porous nature of exposed concrete, proposed assemblies indicate a fully insulated wall assembly on the inside face of exterior concrete. Thermal performance was significantly improved by 173% and 168% for respective assemblies. However, a completely moisture tight assembly is very difficult to achieve due to lack of any openings in the exterior concrete. Though, proposed assemblies do not trap moisture and allow for evaporation at the exterior side. This is reflected in the moisture flux values at the interior of the assemblies, which were reduced by 50% to an almost 0 value at the typical concrete exterior wall assembly and to negative pressure digits at the typical prism exterior wall assembly. Relative humidity is also reduced by about 20% at both exterior assembly types. Air cavities did not provide improved moisture mitigation results due to lack of any weep holes or openings in the exterior concrete layer. These interventions would imply that significant restoration of interior finishes at the colorful, public spaces would need to be meticulously restored and not necessarily impact the significant proportion of more uniform interior plaster finishes at the administrative office spaces.

## 5.0 CONCLUSION

Final research results showed that the building skin of *Spomen Dom* is not well performing and adds to the deterioration of this historically significant building. Careful renovations of the opaque building enclosure should include incorporating continuous spray foam insulation and vapor permeable air barrier at minimum to reduce condensation on the interior layers of assemblies and to allow for evaporation in lieu of trapping built up moisture shown presently. Additional insulation can significantly improve the thermal resistance of both assemblies in this cold climate. Renewing the glazed facades into intended double skin would benefit from incorporating double low-e glazing units on the exterior, adding the interior glazed façade, adding shading elements within the air cavity, modifying operation of the operable leaves closer to construction drawings, and adding small mechanical fans on the roof to propel air circulation within the facade system. The pyramidal skylights would benefit from incorporating double insulated glazing units with careful attention to the flashing details. These strategies would improve the building's thermal and moisture performance while maintaining original design intent and aesthetic qualities. Effort required is extensive. However, as one of few historically significant Brutalist buildings remaining in existence in Montenegro, a building like this deserves to be cherished and sustainably preserved.

## REFERENCES

- Aksamija, A. 2021. *Research methods for the architectural profession*. Routledge.
- Aksamija, A. 2017. *Impact of retrofitting energy-efficient design strategies on energy use of existing commercial buildings: Comparative study of low-impact and deep retrofit strategies*. Journal of Green Building 12 (4): 70-88.
- Aksamija, A. 2013. *Sustainable facades: Design methods for high-performance building envelopes*. John Wiley & Sons, Inc.
- ASHRAE. 2017. Standard 90.1 user's manual: ANSI/ASHRAE/IES standard 90.1-2016: Energy standard for buildings except low-rise residential buildings: I-P and SI2017.
- Bajcinovci B. 2017. *Achieving thermal comfort and sustainable urban development in accordance with the principles of bioclimatic architecture: A case study of Ulcinj (Montenegro)*. Quaestiones Geographicae, 36 (4): 131-40.
- Bazaz, A., Bertoldi, P., Buckeridge, M., Cartwright, A., De Coninck, H., Engelbrecht, F., Jacob, D., et al. 2018. *Summary for urban policy makers - What the IPCC special report on global warming of 1.5°C means for cities*. C40 Cities.
- Koselj, N., 2018. *Edvard Ravnikar and the heart of the city: The genesis of cultural centers in Slovenia and in ex-Yugoslavia*. Journal / International Working-Party for Documentation and Conservation of Buildings, Sites and Neighbourhoods of the Modern Movement, (59): 54-59.
- Kosir, F. 2010. *Od ljudskog ka izvanljudskom*. SAZU Slovenska Akademija Nauka i Umjetnosti i CANU Crnogorska Akademija Nauka i Umjetnosti.
- Kulić, V., Mrduljaš, M. and Thaler, W. 2012. *Modernism in-between: The mediatory architectures of socialist Yugoslavia*. Jovis Verlag GmbH.
- Niebyl, D. 2018. *Spomenik monument database*. FUEL.
- Scepanovic, D. 2020. *Kolašin: Spomen-dom godišnje troši 25.000 eura za struju (translation: Kolasin: Spomen-dom spends 25,000 euros/year on electricity)*. Vijesti.
- Scepanovic, D. 2019. *Propada nekadašnji ponos Kolašina (translation: Decay of Kolasin's historic pride)*. Vijesti.
- Stamatovic - Vuckovic, S. 2018. *Architectural communication: Cultural centers in montenegro / 1945-2000*. Podgorica: University of Montenegro.
- Stamatovic - Vuckovic, S., and Kujundzic, K. 2014. *Architecture of the 20th century as a cultural heritage: Architectural communication - Memorial Hall in Kolasin, Montenegro*. Architecture & Urban Planning (9): 47-52.
- Stierli, M., Emerson, S., Kulić, V., Jeck, V. and Bjažić Klarin, T. 2018. *Toward a concrete utopia: Architecture in Yugoslavia, 1948-1980*. The Museum of Modern Art.
- Tobias, L., Vavroustos, G. and et al. 2009. *Retrofitting buildings to be green and energy-efficient: Optimizing building performance, tenant satisfaction, and financial return*. Urban Land Institute.
- Todorović, M. S., Ećim-Đurić, O., Nikolić, S., Ristić, S., & Polić-Radovanović, S. 2015. *Historic building's holistic and sustainable deep energy refurbishment via BPS, energy efficiency and renewable energy—A case study*. Energy & Buildings, 95, 130-137.
- US DOE. United States Department of Energy. <https://www.energy.gov/>

# Built and Social Environment Impact on Covid-19 Transmission

Ming Hu<sup>1</sup>, Jennifer Roberts<sup>1</sup>, Gesine Pryor Azevedo<sup>1</sup>, David Milner<sup>1</sup>

<sup>1</sup>University of Maryland, College Park, MD

**ABSTRACT:** The goal of this research was to investigate the multifaceted interrelationships between the built and social environments and the impact of this relationship on population-level health in the context of the novel coronavirus disease 2019 (COVID-19). More specific, this study assessed the relationship between several social determinants of health, including housing quality, living condition, travel pattern, race/ethnicity, household income, and COVID-19 outcomes in Washington, D.C (DC). Using built environment and social environment data extracted from DC energy benchmarking database and the American Community Survey database, more than 130,000 housing units were analyzed against COVID-19 case counts, death counts, mortality rate, age adjusted incidence rate and fatality rate data for DC wards. The results demonstrated that housing quality, living condition, race and occupation were strongly correlated with COVID death count.

**KEYWORDS:** COVID-19, built environment, social environment, DC

## INTRODUCTION

Substantial scientific evidence gained in the past decade has shown that various aspects of the built environment can have profound and directly measurable effects on both physical and mental health outcomes at the population level [1]. These effects have been particularly impactful to the already existing burdens of illness experienced among low-income populations and communities of color [2-4]. However, there are two primary gaps.

First, clearly demonstrating the connection between built environment and health disparities has proven to be challenging to the scientific community due to a variety reasons, such as a need for detailed and quality neighborhood data as well as location-based built environment data. Traditional studies have often lumped many important components of the built environment into a blanket socioeconomic status variable. But this approach makes it nearly impossible to tease out discrete housing and community characteristics related to certain diseases [5].

Second, in the past couple decades, the focus on the association between the built environment and public health has been mainly focused on chronic disease rather than infectious disease [6]. Specifically, in many countries around the world the devastating ascent of childhood and adult obesity rates in addition to obesity related chronic diseases has gleaned the attention of active living researchers [7-9]. As such, built environment factors related to physical activity, including sidewalks [10], bike paths [11], greenspace [12], and recreation facilities [13], have been studied extensively. Limited studies have focused on built environment factors linked to indoor air quality and subsequently infections disease, such as the physical and structural condition of buildings and homes [14].

The novel coronavirus disease 2019 (COVID-19), caused by the severe acute respiratory syndrome coronavirus 2 (SARS-CoV-2), was detected in December 2019. Following the original site of detection, Wuhan, China, infections spread across China and other countries around the world. In January 2020, COVID-19 was first confirmed in the United States when a man was diagnosed after returning to Washington State from travel in Wuhan, China. When there were over 125,000 cases and 4500 deaths worldwide, the World Health Organization classified the COVID-19 outbreak a pandemic in March 2020 [15]. As of August 1, 2020, there were over four and half million confirmed cases and 154,333 deaths in the United States [16].

Since the beginning of the pandemic, there has been a surge of research focused on the impact of built environment factors, such indoor air quality and building design, in the transmission of infectious disease environmentally mediated pathways [17-19]. Most studies have focused on the strategies for reopening office buildings [20-22] and schools [23]. However, there has been limited research on residential housing [24]. In the foreseeable future, the majority of people will continue to work from home either entirely or partially. Therefore, it is essential to understand the influence of housing quality on public health in the context of COVID-19 in order to provide knowledge and insights to policy makers and other stakeholders. To this extend, this study addresses such gap by examining the association of built environment and social-economic factors with COVID-19 incidence, mortality and fatality rates.

## 1.0 INFLUENCING FACTORS

### 1.1 Built Environment Factors

Poor housing and building quality has been found to be associated with mold, moisture, and dust mites, which can trigger a variety of health issues including asthma and other respiratory conditions<sup>[6]</sup>. Studies have shown that negative aspects of poor housing and built environment conditions can magnify health disparities and exacerbate already distressing conditions<sup>[1]</sup>. Housing quality, a composition of several determining factors, has been defined as “the physical condition of a person’s home as well as the quality of the social and physical environment in which the home is located”<sup>[xxiii]</sup>. In this study, seven factors used to index built environment and housing quality and impact have been identified: (1) *housing age* (HA); (2) *housing size* (HS); (3) *housing energy efficiency* (HEE); (4) *crowding ratio* (CR); (5) *greenspace ratio* (GSR); (6) *DC student who lives and attends school in the same wards ratio* (STR); and (7) *commute time to work* (CT) (Table 1).

HEE, HA and HS together was used as a proxy measure of housing physical condition. The United States did not employ a national model building energy code until 1994<sup>[xxiv]</sup>. Therefore, without energy retrofit older houses are generally less energy efficient. As such, this research assumed that older buildings with good energy performance underwent renovation, and maintenance/operation has been kept up to date. And those factors together are standard indicators for the condition of housing units.

CR and GSR together was used as a proxy measure of residents’ living condition. CR is different from urban density. Urban density, which maintains attributes of behavior and flow, describes the dimensions of relationships between attributes of urban substance. Specifically, it is a measurement of the number of houses per acre or the number of people per acre and provides insight on how close the buildings or houses are located to one another<sup>[xxv]</sup>. Crowding measures how many households have more occupants than rooms. Previous study have shown that urban density positively relates to the number of current COVID-19 cases, but the effect is relatively small<sup>[xxvi]</sup>.

Compared to urban density, household crowding is a strong predictor of the COVID-19 risk. There has been consistent analysis demonstrating the correlation between crowding and COVID-19 cases in New York City<sup>[xxvii]</sup>, Chicago<sup>[xxviii]</sup> and other major metropolitan areas. GSR was used as a proxy for measuring access to greenspace. Generally speaking greenspace access has a positive impact on physical and mental health<sup>[xxix xxx]</sup>. And, the racial disparity in access to greenspace has well documented. There are spatial and social disparities in tree canopy coverage<sup>[1]</sup>, park quality<sup>[2, 3]</sup>, and even how greenspace is distributed<sup>[4]</sup>. During the COVID-19 social distancing mandates, there were numerous reports of inequities related to the availability of safe parks in cities across the country<sup>[5-7]</sup>. STR and CT measured the adjacency between housing to school and work, together they measured the residents’ travel pattern.

### 1.2 Social Environment Factors

In this study, data from the American Community Survey (ACS) database, which has four subject areas: social, economic, housing and demographic, were used. Eight social-economic variables were identified at ward level: (1) *Black American ratio* (BAR); (2) *median age* (MA); (3) *age>65 ratio* (A65), (4) *median household income* (HI); (5) *poverty rate* (PR); (6) *family to non-family household ratio* (FNR); (7) *foreign born ratio* (FBR); (8) *essential to non-essential worker ratio* (ENR) (Table 2).

BAR, which is defined as the ratio of Black or African Americans to White Americans, MA and A65 together represented the vulnerable population ratio by ward; this category was defined as demographic status. HI, PR were used to present economic status. FNR and FBR together represented household composition category. The ENR defined the occupation category. The ACS provides the count of the number of workers over age 16 within a given ward, as well as the count employed in each of 5 discrete categories; management, business, science and arts occupations; service occupations; sales and office occupations; natural resources, construction and maintenance occupations; and production, transportation and material moving occupations.

Based on the DC government definition of “Essential” and “Non-Essential” workers during the period of the COVID-19 shutdown, the service, natural resources, and production/transportation categories of occupation were considered to be “Essential”. The remaining categories of management and sales were considered “Non-Essential” occupation categories. The ENR is the sum of the population in the “Essential” categories in a given ward was divided by the sum of the “Non-Essential” workers in the given ward to get a proportion of Essential to Non-Essential workers.

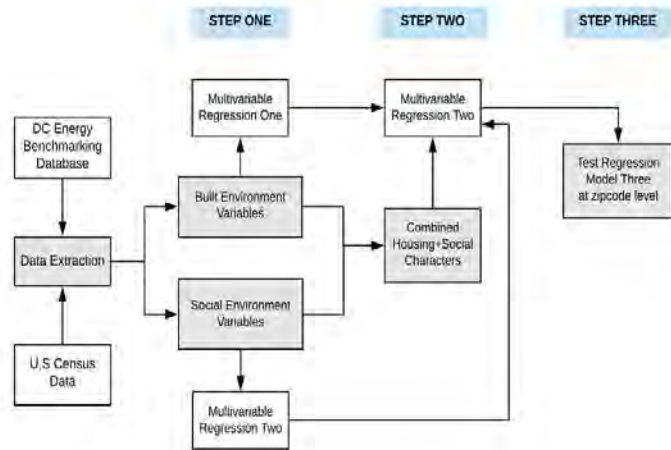
Factors	Abbreviation
<b>BUILT ENVIRONMENT FACTORS</b>	
Housing Age	HA
Housing Size	HS
Housing Energy Efficiency	HEE
Crowding Ratio	CR
Greenspace Ratio	GSR
DC Student School Ward Ratio	STR
Work Commute	CT
<b>SOCIAL ENVIRONMENT FACTORS</b>	
Black American Ratio	BAR
Median Age	MA
Age>65 Ratio	A65
Median Household Income	HI
Poverty Rate	PR
Family/Non-Family Ratio	FNR
Foreign Born Ratio	FBR
Essential/Non-Essential Ratio	ENR

**Table 1:** Built and Social Environment Factors

## 2.0 METHOD AND DATA COLLECTION

As illustrated in Figure 1, the research methodology of this study was composed of three steps. For each step, separate multivariable regression models were created, in order to determine the association between built and social

environment variables with COVID-19 outcomes. In step one, the built environment (housing) variables were grouped into three categories assuming their interrelated nature: *Housing Quality* (HA, HS, HEE), *Living Condition* (CR, GSR), and *Travel Pattern* (CT, STR). These built environment variables were then regressed on current COVID-19 outcomes. The same method was used to examine current COVID-19 outcomes in relation to the social environment characteristics of DC residences. The most influential built environment and social environment variables were identified at wards level from the regression models. Then, in the second step, the most influential predictors from each domains were combined to create a multivariable regression model. In the last step, the combined model was tested at neighborhood level for this robustness. In addition, based on the combined regression model, a geographic heat map was generated to project the potential cases at zipcode level, in order to identify the hot spots at the neighborhood level, and make suggestion on allocating more sources to those potential hot spots.



**Figure 1:** Research Methodology

## 2.1 Data Acquisition

Housing character data were downloaded from DC Energy Benchmark database. In 2008, DC passed the Clean and Affordable Energy Act (CAEA), which requires that all buildings with a gross floor area of 50,000 ft<sup>2</sup> (4,645 m<sup>2</sup>) or greater to report their actual building energy and water use annually. The benchmarking is done according to the ENERGY STAR Portfolio Manager® by the U.S. Environmental Protection Agency [xxxix]. It was developed to provide a method for comparing the energy consumption of a building with that of similar activities, adjusting for size, climate, and operational characters [xxxix-xxxix]. This method makes it possible to determine each buildings' age, size, location, and current physical condition (use EUI as indicator). Since 2012, the DC has released energy benchmarking data for more than a thousand buildings under the benchmarking law [xxxix]. It includes multifamily residences, offices, education buildings, mixed-use buildings, hospitals, libraries, hotels, K-12 schools, among others. For this study, the dataset from 2019 (based on 2018 operations), which has the highest data reporting compliance (1,343 buildings) was used.



Among all buildings included in the 2019 report, buildings that were exempt from 2019's disclosure, those that currently have data under review, and those with no report received were excluded, which resulted in 1,333 buildings. Of those buildings, there were multifamily housing (672), total 116,732,026ft<sup>2</sup>. The average unit size in DC is around 844 ft<sup>2</sup>, so all together around 138,298 units are reported in 2019 DC Energy Benchmark database [xxxv]. The released data includes both descriptive and energy use information; appendix table A1 lists the specific information released for each building [9]. Meanwhile, the U.S. Census Bureau's 2010-2014 ACS, reports approximately 357,815 housing units including single unit housing for DC. The single-unit to multi-units housing ratio is around 0.606 [xxxvi]. Hence, the multi-units(multifamily) housing in DC is around 140,979 units. As such, it can be concluded that the multifamily housing units data extracted from the energy benchmarking database represents the normal distribution (>98%) of the overall multifamily housing units in DC. Social demographic data were extracted from the ACS database to calculate age, race, occupation, household composition, commute, and crowding ratio at the ward level. For detailed explanation, refer to appendix. Finally, the COVID-19 outcome data was extracted from the DC government coronavirus online dashboard, which published daily statistics [xxxvii]. The data include total COVID-19 case counts, age adjusted incidence rates and death counts by ward, race, sex, and age. Using these data, COVID-19 mortality and fatality rates by ward were calculated. This study used data from August 02,2020 (Figure 2).

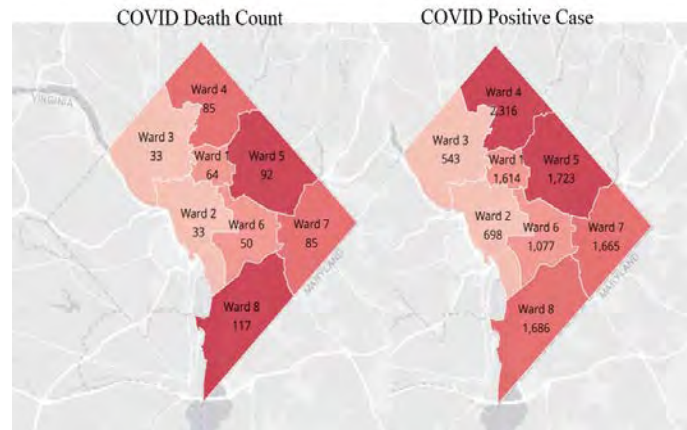


Figure 2: COVID-19 Case Count and Death Count, August 02, 2020

**2.2 Statistic Analysis**

As mentioned previously, a three-step analysis was used (Figure 3). First, separate multi-variable regression models were created for built environment factors and social environment factors. After determining the influential predictors (significant variables), multicollinearity test were conducted to determine the dependence of those variables. Variables that were highly dependent on other variables (VIF >10 is used as cut score) were ruled out. Then the fitness of the built environment model and social environment model were compared within the dataset using the likelihood ratio test (LRT) to determine the power of the models. Lastly, the most influential built environment predictors and social economic predictors were combined into a final multi-variable regression model to study the dynamics of those predicators to relation of COVID-19 outcomes. In order to determine if different categorical built environmental variables could explain the relationship between built environment conditions and current COVID-19 development, three multi-variable regression models were created and adjusted for demographics ( Eq. 1-3). COVID-19 outcomes of case count, death count, mortality rate and fatality rate, and the age adjusted incidence rates were the dependent variables.

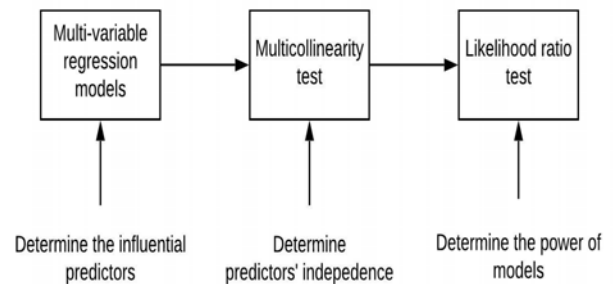


Figure 3: Statistic Analysis Flow

For Housing Quality (HA, HS, HEE)

$$Y_i = \beta_0 + \beta_1 (HA) + \beta_2 (HS) + \beta_3 (HEE) + \mu_i \quad \text{Eq.1}$$

For Living Condition (CR, GSR)

$$Y_i = \beta_0 + \beta_1 (CR) + \beta_2 (GSR) + \mu_i \quad \text{Eq.2}$$

For Travel Pattern (CT, STR)

$$Y_i = \beta_0 + \beta_1 (CT) + \beta_2 (STR) + \mu_i \quad \text{Eq.3}$$

Where  $Y_i$  is the COVID-19 index per ward;  $\mu_i$  is the random effect of intercept for ward  $i$ .

Following the same procedure used for built environment variables, four multi-variable regression models were created and adjusted for demographics (Eq.4-7) to determine the relation between social environment factors and COVID-19 outcomes.

For Demographic Status (BAR, MA, A65)		
	$Y_i = \beta_0 + \beta_1 (BAR) + \beta_2 (MA) + \beta_3 (A65) + \mu_i$	Eq.4
For Economic Status (HI, PR)		
	$Y_i = \beta_0 + \beta_1 (HI) + \beta_2 (PR) + \mu_i$	Eq.5
For Household Composition (FNR, FBR)		
	$Y_i = \beta_0 + \beta_1 (FNR) + \beta_2 (FBR) + \beta_3 (ENR) + \mu_i$	Eq.6
For Occupation (ENR)		
	$Y_i = \beta_0 + \beta_1 (ENR) + \mu_i$	Eq.7

### 3.0 FINDINGS AND RESULTS

#### 3.1 Built Environmental Variables

DC housing unit types included 1-unit, detached (detached single-family house), 1-unit, attached (attached detached single-family house), and 2 units, 3 or 4 units, 5 to 9 units (low-rise multistory, multi-family housing), 10-19 units, 20 or more units (high-rise multistory, multi-family housing) (Figure 4). Ward 2 provided the most units, followed by Ward 6, Ward 3 and Ward 1, respectively. The most common housing types in Wards 1, 2, 3 and 6 were “10-19 units” and “20 or more units” high-rise multistory, multi-family housing, which were accompanied with a relatively low crowding ratio. On the contrary, Wards 4, 5, 7, 8 had predominately a single-family housing type, but with higher crowding ratio. Specifically, in Ward 4, there were the fewest amount of housing units, but with the second highest crowding ratio in DC. The crowding ratio was calculated based on aggregated data extracted from United States Census Bureau.



Figure 4: Washington DC Housing Unit Mix

The housing quality, living condition and travel pattern for each individual ward has been presented in Table 2. For median housing age, Ward 6 had the newest and largest building stock. Ward 1 had the oldest housing stock and highest energy efficiency. With the lowest source EUI, this was an indication that these older Ward 1 buildings underwent some building system renovations or upgrades, hence it was possible that these housing units had a better physical quality than some of the newer buildings in other wards. In terms of crowding, the homes with more than 1.5 persons per range were counted as severely crowded and the homes with 1.01-1.5 persons were considered moderately crowded [xxxviii]. Ward 1 had the highest crowding ratio (6.1%), followed by Ward 4 (4.3%) and Ward 8 (4.5%). Overall, the crowding ratio was aligned with housing types, and the townhouses (1-unit, attached) contributed to the most to crowding ratio (Figure 4). The availability of greenspace followed a similar trend as CR, except for Wards 3 and 4 having a GSR of 5.8 and 4.0, respectively. Ward 8 had the longest commute to work time (36.5 mins) followed by Ward 4 (32.9 mins) and 5 (30.9 mins). Ward 8 also had the highest rate of students attending the school in the same ward (79%), followed by Ward 7 (68%) and 3 (57%).

Ward	Housing Quality			Living Condition		Travel Pattern	
	Housing Age (HA) Years	Housing Size (HS) Square Ft	Housing Energy Efficiency (EUI)	Crowding Ratio (CR)	Greenspace Ratio (GSR) Square Ft/p	Work Commute Time (CT) Minutes	School Attendance-Same Ward Ratio (STR)
1	1949	88,325	106.7	0.06	2.2	29.7	0.37
2	1968	105,370	126.3	0.03	1.5	24.0	0.18
3	1954	125,775	112.5	0.02	5.8	28.6	0.57
4	1955	72,204	112.1	0.04	4.0	32.9	0.56
5	1967	70,145	124.0	0.03	6.3	30.9	0.39
6	1985	205,865	123.6	0.02	5.2	26.9	0.40
7	1964	97,084	117.6	0.02	15.9	36.4	0.68
8	1965	106,336	109.3	0.05	16.7	36.5	0.79

**Table 2:** Built Environment Variables

### 3.2 Social Environmental Variables

Approximately 13.5% of all DC families live below the poverty line, yet Ward 7 (27.7%) and 8 (36.8%) had poverty rates more than double the average DC rate [25]. Social economic variables per ward has been listed in Table 3. As such Wards 7 and 8 also have the most homogeneous populations with nearly all African American residents as indicated by BAR values of 0.95 and 0.94, respectively. Interestingly Ward 8 had the lowest median age (28.9 years) as well as the highest family to non-family ratio (1.45). This may indicate several households with boarders or renters mixed in with families. Ward 4 had the highest FBR with 0.22 while Ward 8 had the lowest with 0.03. Finally, the highest proportions of essential workers were residents of Wards 7 (0.64) and 8 (0.76). Wards 7 and 8 had the highest percentage of workers in retail, healthcare and food services, industries that were determined to be essential [xxxx xl].

Ward	Demographic Status			Economic Status		Household Composition		Occupation
	Black American Ratio (BAR)	Median Age (MA) Years	Age >65 (A65)	Median Household Income (HI)	Poverty Rate (PR)	Family/Non-Family Ratio (FNR)	Foreign Born Ratio (FBR)	Essential/ Non-Essential Ratio (ENR)
1	0.32	31.3	4,869	\$80,794	13.6	0.51	0.22	0.29
2	0.10	30.9	6,304	\$99,422	14.3	0.29	0.20	0.11
3	0.08	36.2	12,210	\$109,909	9.1	0.69	0.19	0.10
4	0.60	39.2	13,824	\$71,545	11.4	1.33	0.22	0.47
5	0.74	35.5	12,436	\$55,063	17.7	0.87	0.11	0.45
6	0.38	34.2	6,073	\$90,903	13.4	0.61	0.09	0.16
7	0.95	38.1	6,654	\$39,828	27.7	1.11	0.04	0.64
8	0.94	28.9	8,132	\$31,642	36.8	1.45	0.03	0.76

**Table 3:** Social Environment Variables

### 3.3 Regression Analysis – Combined Built and Social Environments

Based on results from the previous regressions, built and social environment variables were included into the final combined regression. Table 4 results revealed that the overall regression model for death count was statistically significant (F=76.50; p=0.0129). High percentage (99.9%) death case was explained by the combination of built and social environment (HA, HS, HEE, CR, CT, BAR, HI, ENR) predictors. However, among the individual variables, only CR showed statistical significance (p<0.05). It can be concluded that based on the current available COVID-19 information, the identified combined built and social environment variables are the strongest and most significant predictors of COVID-19 death counts.

Death Count						
Regression Categories	Variables	R square	ANOVA F Significance	ANOVA F	P-value	Coefficients
Built Environment	HA				0.933	0.12
	HS				0.907	-1.53
	HEE				0.409	0.79
	CR	0.9994	0.0129	76.50	0.034	1707
	CT				0.447	0.73
Social Economic	BAR				0.127	59.36
	HI				0.907	-0.67
	ENR				0.764	-26.32

**Table 4:** Statistical Analysis Results of Combined Built and Social Environment Variables (Death Count)

#### 4.0 DISCUSSION AND CONCLUSION

This study identified a strong association of built and social environment variables, including *housing age, housing size, housing energy efficiency, crowding ratio, work commute, Black American ratio, and essential worker ratio*, with the COVID-19 death count in Washington, DC. From the built environment quality perspectives, our findings aligned with other research examining the impact of housing on public health, such as children’s asthma prevalence [xli], adult’s respiratory issues [xlii xliii], health status among residents of color [xliv], and youth mental health [xlv] .

This research added new knowledge on the role of built and social environments in the current COVID-19 pandemic by systemically comparing COVID-19 outcomes across a range of housing and living conditions in DC, one of the regions in United States with the highest COVID-19 cases and deaths per population since the onset of the pandemic. DC wards with poorer built environments, specifically housing quality, were found to be associated with a higher COVID-19 death count, even after adjusting for individual risk factors, such as race and household income. For example, Ward 4, which had the lowest supply of housing units (9.13%) and the third highest crowding ratio (3.0%), maintained the highest the COVID-19 positive case count as of August 2, 2020. Yet, the highest death count was found in Ward 8, which had the second highest crowding ratio (3.4%). This finding corresponds with previous crowding research showing an association between crowding and the transmission of respiratory infections [xlvi xlvii xlviii]. Overcrowded housing conditions in an urban area like Ward 8, presented a consummate opportunity for increased COVID-19 health risk. Ward 7 had the second highest death count and second lowest supply of housing units (9.29%) [51]. Therefore, those two wards (7 and 8), especially zip code 20020 should be given more attention, provided more testing facilities and health care service in order to prevent the future potential outbreak.

From the social environment perspective, this research also aligns with other recent studies. It was determined that BAR was a significant predictor of COVID-19 death count in the uncombined model. This finding was not unexpected considering that Wards 7 and 8 have the highest percentage of African American residents, thus the highest BAR values. As of August 17, 2020, African American residents held the highest percentage (74%) of COVID-19 deaths throughout all of DC. Similarly, the U.S. has experienced a race based disparity of COVID-19 mortality whereby, the COVID-19 death rates for the African American population in some areas was double or more the actual African American population (e.g., 70% vs. 32% - Louisiana; 41% vs. 14% - Michigan).[xliv]. Although some of these COVID-19 death rates for the African Americans have decreased the disparity still persist in many areas throughout the U.S. including the nation’s capital.

#### REFERENCES

- Hood, E. (2005). Dwelling disparities: how poor housing leads to poor health.
- The DRA Project (Accelerating Disparity Reducing Advances). Using Healthy Eating and Active Living Initiatives to Reduce Health Disparities. Bethesda, MD: Institute for Alternative Futures; 2007. Accessed August 3, 2020. [https://cdn.ymaws.com/chronicdisease.site-ym.com/resource/resmgr/healthequity/he\\_dra\\_report\\_08\\_01\\_using\\_he.pdf](https://cdn.ymaws.com/chronicdisease.site-ym.com/resource/resmgr/healthequity/he_dra_report_08_01_using_he.pdf)
- Saarloos, D., Kim, J. E., & Timmermans, H. (2009). The built environment and health: Introducing individual space-time behavior. *International Journal of Environmental Research and Public Health*, 6(6), 1724-1743.
- Perdue, W. C., Stone, L. A., & Gostin, L. O. (2003). The built environment and its relationship to the public’s health: the legal framework. *American journal of public health*, 93(9), 1390-1394.
- Bhurosy, T., & Jeewon, R. (2014). Overweight and obesity epidemic in developing countries: a problem with diet, physical activity, or socioeconomic status?. *The Scientific World Journal*, 2014.
- Sallis, J. F., Cutter, C. L., Lou, D., Spoon, C., Wilson, A. L., Ding, D., ... & Mignano, A. (2014). Active living research: creating and using evidence to support childhood obesity prevention. *American journal of preventive medicine*, 46(2), 195-207.
- Knuiman, M. W., Christian, H. E., Divitini, M. L., Foster, S. A., Bull, F. C., Badland, H. M., & Giles-Corti, B. (2014). A longitudinal analysis of the influence of the neighborhood built environment on walking for transportation: the RESIDE study. *American journal of epidemiology*, 180(5), 453-461.
- Kelly, C. M., Schootman, M., Baker, E. A., Barnidge, E. K., & Lemes, A. (2007). The association of sidewalk walkability and physical disorder with area-level race and poverty. *Journal of Epidemiology & Community Health*, 61(11), 978-983.
- Karnik, S., & Kanekar, A. (2012). Childhood obesity: a global public health crisis. *International journal of preventive medicine*, 3(1), 1.
- Wolch, J. R., Byrne, J., & Newell, J. P. (2014). Urban greenspace, public health, and environmental justice: The challenge of making cities ‘just green enough’. *Landscape and urban planning*, 125, 234-244.



- 11 Kessel, A., Green, J., Pinder, R., Wilkinson, P., Grundy, C., & Lachowycz, K. (2009). Multidisciplinary research in public health: A case study of research on access to greenspace. *Public health*, 123(1), 32-38.
- 12 Taylor, W. C., Floyd, M. F., Whitt-Glover, M. C., & Brooks, J. (2007). Environmental justice: a framework for collaboration between the public health and parks and recreation fields to study disparities in physical activity. *Journal of Physical Activity and Health*, 4(s1), S50-S63.
- 13 Spengler, J. D., & Sexton, K. (1983). Indoor air pollution: a public health perspective. *Science*, 221(4605), 9-17.
- 14 Roberts, J. D., & Tehrani, S. O. (2020). Environments, Behaviors, and Inequalities: Reflecting on the Impacts of the Influenza and Coronavirus Pandemics in the United States. *International Journal of Environmental Research and Public Health*, 17(12), 4484
- 15 Smith, M., Yourish, K., Almkhatar, S., Collins, K., Ivory, D., & McCann, A. (2020). Coronavirus in the US: Latest map and case count. *The New York Times*. Accessed August 3, 2020. <https://www.nytimes.com/interactive/2020/us/coronavirus-us-cases.html>
- 16 Dietz, L., Horve, P. F., Coil, D. A., Fretz, M., Eisen, J. A., & Van Den Wymelenberg, K. (2020). 2019 novel coronavirus (COVID-19) pandemic: Built environment considerations to reduce transmission. *Msystems*, 5(2)
- 17 Bolashikov, Z. D., & Melikov, A. K. (2009). Methods for air cleaning and protection of building occupants from airborne pathogens. *Building and Environment*, 44(7), 1378-1385.
- 18 Neal T. COVID-19 and the Built Environment. Colin, Biggers and Paisley Lawyers. [(accessed on 30 April 2020)]; Available online: <https://www.cbp.com.au/insights/insights/2020/march/covid-19-and-the-built-environment>.
- 19 The Harvard Gazette. "A five-layered defense for workplace reopening." accessed July 20, 2020. <https://news.harvard.edu/gazette/story/2020/04/looking-at-covid-19-through-healthy-building-eyes/>
- 20 Forbes. "Why COVID-19 raises the stakes for healthy buildings." Accessed July 20, 2020. <https://www.forbes.com/sites/hbsworkingknowledge/2020/06/08/why-covid-19-raises-the-stakes-for-healthy-buildings/#1babc5324cd>
- 21 The Harvard Gazette. "Healthy buildings expert outlines recommendations for school reopening." Accessed July 20, 2020. <https://news.harvard.edu/gazette/story/2020/06/harvard-expert-outlines-recommendations-for-school-reopenings/>
- 22 Guyot, K., & Sawhill, I. V. (2020). Telecommuting will likely continue long after the pandemic.
- 23 Office of Disease Prevention and Health Promotion. "Healthy People: Quality of Housing." Accessed August 3, 2020. <https://www.healthypeople.gov/2020/topics-objectives/topic/social-determinants-health/interventions-resources/quality-of-housing>
- 24 Hu, M., & Qiu, Y. (2019). A comparison of building energy codes and policies in the USA, Germany, and China: progress toward the net-zero building goal in three countries. *Clean Technologies and Environmental Policy*, 21(2), 291-305
- 25 Roberts, B. H. (2007, November). Changes in urban density: its implications on the sustainable development of Australian cities. In proceedings of the state of australian cities national conference (pp. 720-739).
- 26 Scientific American. "Are crowded cities the reason for the COVID-19 Pandemic?" Accessed July 19, 2020. <https://blogs.scientificamerican.com/observations/are-crowded-cities-the-reason-for-the-covid-19-pandemic/>
- 27 Medical press, "Study examines the prevalence of COVID-19 infections in pregnant women." Accessed July 19, 2020. <https://medicalxpress.com/news/2020-06-prevalence-covid-infections-pregnant-women.html>
- 28 PropPublic Illinois. "In Chicago, Urban density may not be to Blame for the spread of the coronavirus." Accessed July 19, 2020. <https://www.propublica.org/article/in-chicago-urban-density-may-not-be-to-blame-for-the-spread-of-the-coronavirus>
- 29 Zhang, J., Yu, Z., Zhao, B., Sun, R., & Vejre, H. (2020). Links between greenspace and public health: a bibliometric review of global research trends and future prospects from 1901 to 2019. *Environmental Research Letters*, 15(6), 063001
- 30 Kondo, M. C., Fluehr, J. M., McKeon, T., & Branas, C. C. (2018). Urban greenspace and its impact on human health. *International journal of environmental research and public health*, 15(3), 445.
- 31 District Government, Department of Energy & Environment. "About Benchmarking." Accessed July 6, 2020. <https://doee.dc.gov/node/572012>
- 32 Scofield, J. H. (2013). Efficacy of LEED-certification in reducing energy consumption and greenhouse gas emission for large New York City office buildings. *Energy and Buildings*, 67, 517-524
- 33 Energy Star Portfolio Manager. Accessed July 6, 2020. <https://www.energystar.gov/buildings/facility-owners-and-managers/existing-buildings/use-portfolio-manager>
- 34 Department of Energy & Environment, DC gov. "Building benchmarking dataset." Accessed July 6, 2020. <https://doee.dc.gov/publication/2017-building-benchmarking-dataset>
- 35 <https://dc.urbanturf.com/articles/blog/dc-apartments-the-fourth-smallest-nationwide/14739>
- 36 District of Columbia. "Office of planning, Census and Demographic Data." Accessed July 21, 2020. <https://planning.dc.gov/page/census-and-demographic-data>
- 37 Government of the District of Columbia. "Coronavirus Data." Accessed August 3, 2020. <https://coronavirus.dc.gov/page/coronavirus-data>
- 38 United States Census Bureau. "Census of Housing." Accessed July 21, 2020. <https://www.census.gov/hhes/www/housing/census/historic/crowding.html>
- 39 National Conference of State Legislatures. "COVID-19: essential workers in the States." Accessed August 3, 2020. <https://www.ncsl.org/research/labor-and-employment/covid-19-essential-workers-in-the-states.as>
- 40 Government of the District of Columbia. "Mayor Bower orders closure of non-essential businesses." Accessed August 3, 2020. <https://coronavirus.dc.gov/release/mayor-bowser-orders-closure-non-essential-businesses>
- 41 Sun, Y., & Sundell, J. (2013). On associations between housing characteristics, dampness and asthma and allergies among children in Northeast Texas. *Indoor and Built Environment*, 22(4), 678-684.
- 42 Spengler, J., Neas, L., Nakai, S., Dockery, D., Speizer, F., Ware, J., & Raizenne, M. (1994). Respiratory symptoms and housing characteristics. *Indoor air*, 4(2), 72-82.
- 43 Turcotte, D. A., Chaves, E., Gore, R., Adejumo, K. L., & Woskie, S. (2018). The impact of housing type on low-income asthmatic children receiving multifaceted home interventions. *Public Health*, 164, 107-114.
- 44 Ortiz, S. E., & Zimmerman, F. J. (2013). Race/ethnicity and the relationship between homeownership and health. *American journal of public health*, 103(4), e122-e129.
- 45 Fenelon, A., Slopen, N., Boudreaux, M., & Newman, S. J. (2018). The impact of housing assistance on the mental health of children in the United States. *Journal of health and social behavior*, 59(3), 447-463.
- 46 Fonseca, W., Kirkwood, B. R., Victora, C. G., Fuchs, S. R., Flores, J. A., & Misago, C. (1996). Risk factors for childhood pneumonia among the urban poor in Fortaleza, Brazil: a case-control study. *Bulletin of the World Health Organization*, 74(2), 199.
- 47 Kumie, A. (2002). Crowding in a traditional rural housing (Tukul) in Ethiopia. *Ethiopian Journal of Health Development*, 16(3), 303-308.
- 48 Ali, S. H., Foster, T., & Hall, N. L. (2018). The relationship between infectious diseases and housing maintenance in Indigenous Australian households. *International Journal of Environmental Research and Public Health*, 15(12), 2827.
- 49 Government of District of Columbia. "Coronavirus Data." Accessed August 19, 2020. <https://coronavirus.dc.gov/page/coronavirus-data>

# Intentional and Unintentional Performance: Analyzing the Validity and Agency of Ancient Environmental Design on Contemporary Architecture Advancement

Sandra Maria Bernal Cordova<sup>1</sup>, Joaquin Murrieta-Saldiva<sup>2</sup>, Ivan Eladio Gaxiola Camacho<sup>1</sup>

<sup>1</sup>University of Arizona, Tucson, AZ

<sup>2</sup>Watershed Management Group, Inc., Tucson, AZ

**ABSTRACT:** Globally adverse environmental conditions, such as land degradation, lack of fresh water, and extreme temperature levels, represent the rationale for incorporating cross-scalar and interdisciplinary knowledge, looking forward to achieving a more adaptive urban environment. In the face of the climate crisis, architecture and urban practice need to embrace holistic design approaches and consider resilient architecture since this can operate while adapting to needs, demand, environmental conditions, and natural resources availability. This research involves documented observations of architectural and urban sites where the focus is on the intentional and unintentional elements that, when interacting with the socio cultural and environmental context, become part of the resiliency of buildings. The goal is to reach a critical identification and re-interpretation of intentional and unintentional elements of a sustainable lifestyle after comparing examples of ancient and contemporary architecture. Helped also with a sample site in Tucson, Arizona, this research describes the building as a dynamic system, using the Food-Energy-Water (FEW) nexus perspectives and comparative evaluation of ancient and contemporary architecture. Far from a nostalgic design standpoint or disapproval of technological development, this research re-focus on ancient vernacular architecture practice. Simultaneously, calling for considering the possibilities of an adequate recoupling of buildings with food production, water use, and energy efficiency to improve their environmental performance examining the validity and agency of ancient environmental design elements for a more sustainable practice of contemporary architecture.

**KEYWORDS:** arid regions, bioclimatic architecture, ancient, contemporary

## INTRODUCTION

The United Nations described in 2017 how harmful environmental conditions are impacting the world. Land degradation, lack of freshwater, pollution, and extreme temperature levels are among the climatic crises seen in arid Arizona. In arid regions, settlements currently follow socio-economic pressures from where the expansion of the urban footprint is for the most worrying because population growth leads to desertification. Along with the exploitation of surface and groundwater deposits, urban sprawl accounts for other environmental damage dimensions like land cover change, deterioration of native landscapes due to vegetation removal. These disturbances create dependency on the municipal infrastructure. Ideally, contemporary civilizations will look for an equilibrium between technological innovation and sustainability. Such an approach has been key to developing the most antique societies among which the Greek, Roman and the Indigenous approach to the built environment are explained in the form of reflections in this research.

Architectural approaches such as the smart city models, Low Impact Development standards, and the Green Building Industry across the U.S have gained attention in the last 20 years. By supporting the triple-bottom-line of sustainability (economy, society and environment, AKA place, people and profits), these strategies resolve existing problems that the built environment causes to nature and human health. In a striking scenario of future hotter and drier conditions in Arizona, indoor spaces may only rely on electricity for refrigeration and ventilation, or municipal distribution of water, and in a food distribution system that depends on massive production. A resilient built environment will survive only if the community controls the elements to afford extreme conditions, including a critical observation of their consumption patterns and real needs.

Unintentional design components are those elements of a space that cause unplanned interactions that end up helping human life in facing environmental stresses. Whether it is a tree that provides shade, a rock that becomes a chair, or geomorphology that brings water together in a temporary pond. Those unintentional elements occur, whether we like them or not. Sometimes they do not naturally exist; they are human-made, like the shortcuts we take to go diagonally while a sidewalk was intentionally created to make us walk straight. Observing those unintentional elements, as well as taking climate and the spirit of place into account, is a way in which architects can find ways to craft spaces that better suit people's needs while being environmentally conscious. It is in the transition from vernacular to polite

architecture that intentionality and its counterpart play a crucial role. Since a vernacular space in its purest form is empiric, the discovery, documentation, and mastery of design strategies had to involve trial and error, as well as the experiencing of unintentional design elements, such as when earlier civilizations discovered that shading trees provided shelter against, solar radiation, and predators. The tree was an unintentional element that provided convenient spatial features. It was then used for that purpose until it acquired an intentional degree for the mentioned purpose.

The book “Arizona: A History” by Dr. Thomas Sheridan (1995) discusses how, in this region, people have traveled seasonally since ancient times: the semi-nomadic groups followed climatic cycles to protect their people from extreme weather while monitoring water and food (wild animals and plants) availability. Why is it too hard to think about having different options, not traveling from region to region but for moving seasonally from room to room, or indoor and outdoor, and then make use of the combination between intentional and unintentional strategies for a harmonic living? Because people, especially decision-makers, may not be paying attention to the Food-Energy-Water (FEW) nexus as influential for the planning, construction, and operation of a building. This research aims for critical identification and re-interpretation of elements of a sustainable lifestyle in ancient and contemporary architecture. The main focus is on identifying the intentional and unintentional performance of architectural and urban elements for adapting to climatic stresses through documentation of ancient sustainable strategies and a contemporary sample site of a residential building that adapted to the environmental conditions in Southern Arizona.

## 1.0 METHODOLOGY

### 1.1. Approach

This research aims to critically identify intentional and unintentional elements of a sustainable lifestyle reviewing examples of ancient and contemporary architecture. First, a review of ancient environmental design (AED) principles is made based on literature about records of architectural and urban design of ancient Greek and Roman cultures, paying special attention to vernacularity of the built environment given its potentially positive climatic effects if properly applied, specially at residential scale, by design and building professionals. Then, observations and a collection of notes about a sample site suggested by one of the Co-PI’s show the development and function of systematic environmental design features emphasizing both, the necessary mindset of a building user, and the impact of energy conservative measures at residential scale. Finally, the comparative analysis was carried out following an intentional-unintentional rationale, this is, design strategies were labeled for each category (AED, site, etc.) according to whether their application in the built environment transitioned from or developed into intentional or unintentional elements.

### 1.2. Research question

RQ: Are Intentional and unintentional design and building elements reflecting effective bioclimatic performance in two different times in history? Sub-RQ: What is the studies about ancient architecture provides evidence of the validity and agency of ancient environmental design on contemporary architecture advancement. Considering the degree of intentionality of different spatial elements and their potential resiliency, what is the connection, and to what extent environmental design from ancient Greek and Roman cultures has permeated into local environmental design approaches? How feasible is to use historical knowledge and empirical bioclimatic design to face contemporary concerns of rising temperatures in Tucson?

## 2.0 ANCIENT ENVIRONMENTAL DESIGN

### 2.1. Vernacular-polite architecture

Indigenous and regional architecture are two extremes connected to “vernacular-polite” (Fig. 01). On the one hand,

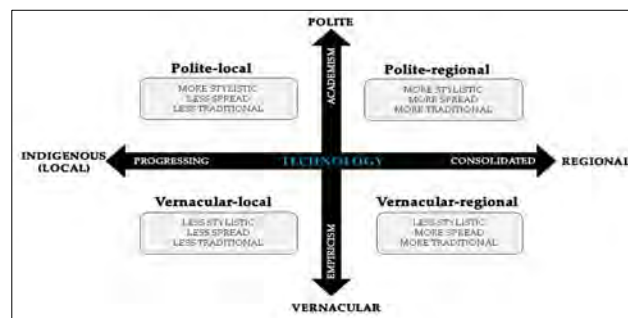


Figure 01. Building technology quadrants with different vernacular degrees.  
Source: Authors, 2021

vernacular are dwellings created by people within a community, established on apprenticeship (pure empirical training) rather than professional or academic preparation. Its architectural scope is functional, based on the use of materials



sourced nearby the building site. On the polite extreme, buildings are conceived through the intervention of a professional or an individual with design training (e.g., architect, engineer, building technician, etc.), not necessarily a native or community member. This type of structure usually aims to solve function and aesthetic demands, implement more advanced building technology than its counterpart, and tend to use both local and imported materials, generally at the expense of a higher environmental impact (Fig. 01) (Ghisleni, 2020). Ideally, indigenous or native architecture represents local-scale spatial solutions of human shelter using simple and pragmatic building shapes, not necessarily referencing to or influenced by pre-existing models. It directly responds to nature and community needs and has a low environmental impact due to locally sourced materials (Richards, 2012). On the other hand, regional architecture tends to be more spread, more exposed to aesthetic influences, and, for these reasons, includes former spatial solutions from different communities or cultures; thus, it can be more stylistic. It depicts a more complex ingenuity level, obtained by training and experience (professional education and accumulated trial-and-error respectively) than the indigenous case.

## 2.1. Bioclimatic principles as applied in the built environment by ancient cultures

Throughout human evolution, dealing with environmental conditions has been key for subsistence, and it is perpetually present and, according to its nature, allows favorable spaces for the human body. These spaces initially existed as natural shelters, such as caves. They were eventually substituted by human-made spaces in the form of buildings and their outdoor surroundings (i.e., public space, infrastructure, etc.), which demand energy to be created and function (Eliasson, 2012). Human thermal comfort is part of the “human-environment” dialectic: about 50% of the thermal comfort depends on environmental factors such as relative humidity, wind speed, and heat transfer through radiation. The remaining portion of comfort is up to human decisions (metabolic activity and clothing), along with prior psychological and physical adaptation (Middel et al., 2016). Not surprisingly, different climatic regions demand specific building typologies to deal with particular atmospheric conditions. To build a case for an AED concept, it is necessary to focus on remarkable examples of how ancient civilizations used the built environment to perform as an interface to mediate with the environment and provide thermal comfort.

### Shading and Cooling using vegetation

Many are examples of public spaces from ancient cultures emphasizing the use of shade from vegetation as part of an all-inclusive approach that helped—among several purposes, reaching a satisfactory “human-space” relationship. The most representative instances are the Greek agora, the Roman Forum, and the sacred groves. The agora and forum performed as the ultimate civic life centers were carried out in their buildings and open square (Erskine, 2009; Miles, 2016; Ulrich & Quenemoen, 2014). The sacred groves focused on developing and conserving vegetated amenities around natural, educational, and religious spaces (Barnett, 2007).

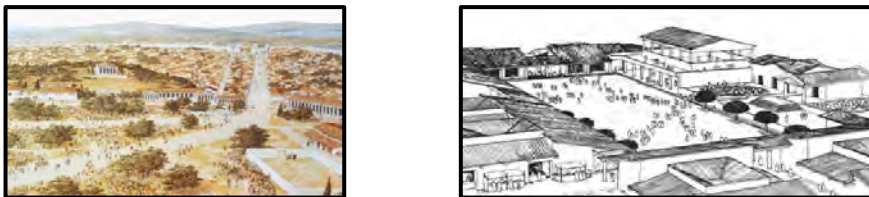


Figure 02. Left: Athenian Agora, 500 BC (Artwork by Peter Colony in Miles 2016). Right: Forum of Cosa, 240 BC (Drawing by Clementsalvi, 2011)

The Athenian agora, known as the "meeting place," is a public outdoor square in the center of the city enclosed by colonnades with stoae, buildings, and temples organized according to integrated internal functions, focusing on the center of the site. Since it was a public and religious site, it was delimited with boundary stones and marble water basins to demand respect for the area. It included decorative features such as statues, altars, trees, and fountains (Encyclopaedia Britannica, 2017; Miles, 2016). Around 500 BC, a statesman of Athens known as Cimon (Kimon) led the planting of trees in the city to have clean and shaded walk paths and set one of the first examples of public urban amenities (Fig.02, left). Specifically, in the Athenian agora, the shade was increased by supplying plane trees following sewage lines' path (Hobhouse, 2020; Wright, 1934). Having the intentional combination of transitional spaces such as the stoae and the shading trees in the open allowed for a healthy, desirable, and prolonged use of the space.

Two more examples of shading trees in the Athenian agora are the small tree group of olives and bay laurels (perhaps replanted in 500 BC) that protected the Altar of the Twelve Gods in the north area of the site, and the presence of planting evidence probably of laurel and pomegranate around the Hephaestion, dating from 3 BC, found by garden archaeologists in the north and south areas of the temple (Hobhouse, 2020; Miles, 2016). These landscape interventions demonstrate the interest of ancient Greeks in urban environmental planning. Using vegetation for human well-being (social and physical) is the ancient landscape feature known as grove, a type of public park that could be dedicated to gods and heroes and was one of the three significant Greek contributions to gardening (the Adonis garden and the country villa were the other two). There could be several urban grooves in each city to get shade, recreation, and schooling. Some of these public parks developed into gymnasiums, all of which were not vegetated since their beginning. For example, in Athens, plane trees were not planted and other groves until Cimon developed his urban

gardening project. (Miles, 2016; Wright, 1934). The Academy, in the Athenian western suburb of Ceramics, was probably the most outstanding because of its shaded walk paths, trim avenues, and a sanctuary to the Muses. Since it had its irrigation system, it was planted with elms, poplars, olive trees, and planes. Epicurius also delivered his lectures in the only garden attached to a suburban Greek house. The shaded avenues in the Academy and the Lyceum were known as the peripatetic. Thus, students and philosophers using these avenues were known as the "peripatetic" philosophers (Barnett, 2007; Hobhouse, 2020; Miles, 2016; Wright, 1934). Temple groves (hierokepis) or sacred groves (alsos) were populated mainly with trees, flower plants, statues, and structures, designated for venerating gods and public heroes. Greeks developed a holistic relationship with nature; it became evident in their use of vegetation to embellish and create comfortable outdoor public spaces.

The Roman Forum has three elements: a major temple, one civic basilica, and an open rectangular central plaza. An emphasis on incorporating or preserving vegetation was absent in this design canon. Each Roman province had layout variations while keeping these three elements present. The forum of Cosa (a republican colonial development founded in 273 BC in Etruscan land) was influenced by these canons and the trend of using a certainly oblong rectangular plaza. Its current dimensions were defined in 240 BC approximately. Unlike the archetypical Roman fora, its plaza was located more into the south-east portion of the city than the center of the urban grid (Cooley, 2016; Ulrich & Quenemoen, 2014). Contrary to the trends and canons above, the forum of Cosa was a unique example of landscape integration: its long sides were flanked with vegetation, as opposed to porticoes: eight trees were planted in "tub-like, rock-cut" pits, four on each of the long sides of the open square entrance (Stillwell et al., 1976). This granted its users the option of partial protection against solar radiation while transiting the open square of the forum or the potential to reach thermal homeostasis if shaded during an adequate amount of time. The corpus of literature used for this document does not describe the tree species grown in this forum. However, given the relatively small biomass and geometric arrangement shown in Fig. 02, the south-west row would have served more stylistic purposes. In contrast, the north-east row could perform mostly as a shading device.

#### **Solar radiation control and evaporative cooling**

Stoas are free-standing structures, based on the ordered repetition of columns (colonnade), extensively used in ancient Greece, mainly for demarcating public spaces such as agoras. Stoas aided in the proper occurrence of events by protecting from environmental conditions, particularly solar radiation during summer and precipitation and wind in winter. A remarkable example is the Stoa Poikile, built around 470 BC north of the Athenian agora (Gates, 2008; Lechner, 2015; Marconi, 2014; Miles, 2016). Design factors influencing the stoa archetype to have effective environmental performance include: its height and pitched roof (favoring air stratification in summer) and, at least in the stoa version with enclosed spaces, having a high thermal mass (increasing the thermal lag of the envelope). However, the envelope could have been negatively impacted if improperly located and orientated within the site. The Roman Colosseum, an amphitheater was built around 80 AD by the Flavian dynasty to gain popularity by providing entertainment. Its formal name was a Flavian amphitheater, but Colosseum was also called Colosseum because of Nero's colossal statue resembling the god Helios located just next to the building. The Colosseum was a four-story, 52m-high building, which provided seating for approximately 50 000 spectators protected against solar radiation by a retractable awning that is believed to have been made of linen. It was suspended by corbels attached to wooden masts located on the topmost floor, requiring about 1,000 men to operate. This shading device did not protect the full seating audience; there was an unprotected circular area at the center. People sitting under the unprotected area used umbraculus and petasus (parasols and hats with a broad rim, respectively). (A Touch of Rome, 2020; Lechner, 2015; Marconi, 2014; Soren, 2017; Ulrich & Quenemoen, 2014). A complementary technique to reach thermal comfort in amphitheaters was the use of "sparsione" or "sparsio," a method relying on direct evaporative cooling. Sparse involved the spraying of scented water breezes over the spectators. This served two functions: first, providing thermal comfort at the expense of increasing humidity in the air, and second, to mitigate undesirable smells coming from sweat and possibly other activities related to the emission of vapor from different substances (e.g., humidity in the building, smells from sanitary areas, etc.) (A Touch of Rome, 2020; Eckstein & Bell, 1882; Jasiński, No date; Nosov, 2009). The intentional combination of shading and evaporative cooling must have been a practical approach to increase the outdoor thermal performance of the Colosseum. By reducing the heat gain from direct solar radiation, a high portion of comfort can be guaranteed. If aided with a reduction of latent heat from evaporative cooling, a higher degree of comfort can have been reached.

#### **Rainwater harvesting and residential gardening**

Clever use of natural resources was practiced in Pompeii, a city founded in 6 - 7 BC in the fertile region of Campania, destroyed after Mount Vesuvius erupted in 79 AD. It was a vibrant place with a population between 10,000 and 20,000 (Cooley, 2016; Gates, 2008). Current records of Pompeiian houses (Domus) date back to 3 BC. Its layout followed the "fauces-atrium-tablinum" axis. The fauces were the main entrance from the street, the atrium was the unroofed central hall, and the tablinum was the most relevant host room. There was a vegetated area or garden (Hortus). Rainwater harvesting occurred at the atrium: a rectangular, central opening (compluvium) allowing rainwater to enter. Below the compluvium, a rectangular catching area (impluvium) was lower than the ground level. Once passed the impluvium, water was stored in an underground cistern with a cavity for water access. (Gates, 2008; Ulrich & Quenemoen, 2014;

Wright, 1934). Gardening in Pompeian Domus occurred in the peristyle, while horticulture was practiced in the Hortus, across the tablinum, or at one end of the parcel. It was common to grow vegetables but also fruit trees, as well as vines (Thommen, 2012)

### 3.0 ENVIRONMENTALLY CONSCIOUS CONTEMPORARY CASE STUDY

A site located in a central part of Tucson, AZ, with a regular 1/5 of an acre property and total rooftop area of 1,989f2 owned by a Cultural Ecologist and wife, whose connection with the built environment did not emerge from a background on architecture at that time, but from interest on the connectivity of people and Nature. Their focus is mainly on urban environments. This home's primary goals are to connect us to Nature and create a productive unit to achieve a regenerative urban-environment. The first adaptation of this urban house was to install a chicken coop for five chickens that they brought with them (figure 3). The first reconnection was with food, just like when the ancient settlements started their sedentary life (figure 4). Without aiming to tag every step on the process of adaptation observed in this site, occasional comments will link the above section of this research with the case to start establishing the necessary connections with the analysis to come. The first two years since the owners moved to this house were mainly observations and understanding their behavior as new arrives in the areas. Also, the identification of heat islands around the property and removal of all the pea-gravel covering the landscape -we looked at the movement of rainwater in and around our property and started creating rain gardens to create pollinator gardens- the owner said. It is then reinforced that food production is the motivation of initial change, but awareness about the site's physical characteristics was also part of the first steps. Among the informed observations, the owner appointed that humans have a responsibility to Nature. Since "we take water from this sensitive arid environment, we must make efforts to restore and recover the aquifer," which also alleviates flooding. He aimed to infiltrate at least 50% of the rain in this property.



Figure 03. Sample site. Source: authors 2020-21

As part of the observations of their behavioral patterns and the Sonoran Desert's environmental consciousness, the next step was to become as close as possible to a zero-waste home. They created a composting toilet and an outdoor shower on the patio and connected the laundry machine to fruit trees (figure 5). By 2019 through the installation of water harvesting on all the roofs, they could store rainwater in a 2,500gal cistern to provide water to vegetable gardens (figure 6). The latest building was an outdoor wooden oven to use the wood from the shade trees' pruning (figure 7). Particularly the front of the house was transformed from a flat gravel area to an inspirational pollinator garden with basins for water infiltration, swales to guide the water where is needed "we even created a little stream that brings stormwater from the street (figure 8)." Water that otherwise will runoff and never stop enough time for feeding shade trees and native shrubs, as it does now. Rockwork was added to maintain the earthworks structures and provide shelter for reptiles and other living organisms. The native plants of the Sonoran Desert offer a lush and abundant environment where there are always flowers, birds, and pollinators. When walking in front of the house, people encounter monarch butterflies and experience their migration as well as their lifecycle bringing an incredible connection and respect for nature "as well as happiness, beauty and green to our desert urban environment."

Back to supporting food production and closing the loop on waste, chickens ate food scraps and pro urban deserts and compost and fertilizers for the vegetables and gardens. The laundry machine recycles gray water to the fruit trees diminishing sewer water and increasing water conservation. Having the compost toilet has been a transformational experience to save 25% of water (not flushing toilets), transforming "poop" into natural fertilizers via compost, which constitutes an excellent amendment o to our soils. Two of the most rewarding and pleasurable installations are the outdoor shower (that recycles gray water to the fruit trees) and the wood oven that provides flavor and outdoor gathering space utilizing the wood produced from mesquites.

### 4.0. COMPARATIVE ANALYSIS

It was inevitable to account for the evolution of the built environment from ancient times to the present. Although the intention was to show how contemporary inhabitants can be inspired by nature without needing to get inspired by a green building, just nature. As a dynamic system, architecture evolved, leaving evidence behind and generating change. As mentioned in the introduction, the standardization of the built environment and the socio-economic pressures boosted most of the built environment's current shape. If the natural environment were in the minds of millions of decision-makers in modern and contemporary history, fewer buildings would be needed. More consciousness would be applied in developing materials and techniques and pursuing a form of satisfaction that does not account for comfort, equilibrium, and respect but in imposition and economic benefits. The comparative analysis (Table 1) highlights the

authors' opinions and informal assessments while visually analyzing each bioclimatic element mentioned in the literature review, observations to the site, and informed opinions. Each element has annotations on whether each elements' nature intentionally or unintentionally benefits the human experience or environmental connection.

Strategies	AED	OEMC	SS
Air flow	U->I	I	U
Composting	NA	I	I
Food gardens	U->I	I	I
Food production	U->I	I	I
Infiltration	U->I	I	U->I
Irrigation systems	U->I	I	I
Landscape interventions	U->I	I	U->I
Plazas	I	I	U
Sewage lines	U->I	I	U->I
Transitional spaces	U->I	U->I	U
Vegetated amenities	U->I	I	I
Walk paths	U->I	I	U->I
Water harvesting	U->I	I	I

**Key:**

**AED**= Ancient Environmental Design, **OEMC**= Other environmental approaches in modern and contemporary architecture, **SS**= Sample Site, **U**=Unintentional, **I**=Intentional, **U->I**= Unintentional that through time became Intentional, and **NA**= Not Assessed/Applicable.

**Table 1: Comparative analysis. Source: Author, 2021**

**DISCUSSION**

A universal and timeless principle to generate high-performance building forms through adaptation to the environment is that high energy use efficiency can be initially achieved through passive design strategies. A building's performance is more likely to be energy minded by adjusting its design to its climate and site by relying on a passive system first and incorporating active approaches for tuning later (Nuffida 2015). In this context, an influential environmental adaptation of buildings in ancient times faced more technological constraints than today, emphasizing passive means. From Table 1:

**Airflow:** vernacular architecture used in windcatchers, transitional spaces, natural ventilation, and passive cooling. Modern applications are passive and mechanical systems for ventilation, heating, and cooling. The site owner did not mention that airflow was either improved or intentionally used to their advantage. However, as part of the cooling effect of shading, airflow is essential for moving fresh air indoors and outdoors. **Composting:** composting toilets and compost from food are recently added to the list of building technologies in response to some green certifications. Previous to the LEED certification and new other incentives for reducing waste, the movements started as an individual decision. In the site, the approach was less innovative and more creative. Departing from the idea that in most months of the year, Arizona has a climatic condition that allows leaving the main house and going to an outdoor toilet, these individual approaches help save water and reduce the impact of processing wastewater. On the food side, composting leftover food and other organic materials (even utilitarian) is a complicated process that, in this case, has closed the loop by combining the strategy with food production on-site (chicken and fruit trees). **Food gardens:** Urban food production was perhaps an unintentional element in ancient settlements that remained as part of the urban landscape with time. Fruit trees and other types of vegetation are used as decoration or amenity. Domestic buildings kept species, herbs, flowers, and small fruits in preparation areas and even just bought smells indoors. This connection was not entirely interrupted by the modern or contemporary built environment. Whether these urban or domestic food production sites are to eat from them or for the smells of aesthetics, gardens remain in urban spaces at different scales. For the sample site, food gardens mean food for them and the wildlife. **Food production:** Of the main reasons for human settlements, growing food is the most critical. During the time between the beginning of agriculture to when transportation was better, the dependency on local production had a role in the configuration of cities and individual buildings. Architecture and urban centers started to protect the people, but more and more, they began to allocate storage, preparation, recollection, cooking, and other related processes. Modern architecture and cities created a more practical approach where fast production and distribution became a priority. These transitions aimed at economic gains and the supply of food regardless of the origin, which led to a dependency on massive distribution, pollution, overproduction, transformation of land, and so on. As for the site, food production was from the beginning a goal. Their site and later improvement observations were a way to link food to their house and way of living. **Infiltration:** On defining the site for settlements and resiliency of urban centers, observing rainfall and surface water is essential. Flood control departs from the idea that water has memory and, regardless of the urbanization, water will always follow the same route to natural discharge. Ancient urban centers and buildings took advantage of waterways to transport fresh water and irrigation. However, its planification left areas for natural deposits and recharge, for example, riparian areas, green urban spaces, and in urbanized areas. Not that there were no failures, but thanks to the lack of the impervious materials available today, urbanization accidentally (or not) provides infiltration opportunities. We see more invasive and aggressive systems in modern and contemporary urbanization processes. Oil-based pavements, roads, and general construction limit natural infiltration to the point that it has to be mandated by city or municipal policy. Later, the lack of

natural infiltration, especially during storms, is followed by floods, some of them destructive. Garbage, oils, low-quality infrastructure, and lack of environmental consciousness lead to more significant impacts such as pollution of significant water deposits and significant structural problems due to runoff. In the site, the owner paid particular attention to natural water behavior and created opportunities to conduct stormwater to their site to infiltrate as much water as possible. This strategy benefits the site as well by feeding vegetation naturally.

**Irrigation systems:** As agriculture developed, civilizations needed to warranty water management and distribution, observing natural patterns, and developing technology. Other approaches relied more on technology for pumping and piping water and developed complex irrigation systems. This massive intervention to nature is a norm for food production, even for those not native. More water is needed for mass production and growing plants that do not belong to the natural environment. Usually, water will be taken from lakes, rivers, and underground deposits far from the agricultural fields. Irrigation also applies to other green elements that do not are for food production. Grass, trees, and domestic plants used for aesthetics are the urban landscape's main components. However, most times, inspiring and overall benefits are not sustainable because nonnative and heavy water demand plants are used. Through observations, in the sample site, the irrigation is natural and efficient because the plants are native and use rainwater and greywater, combining passive and active strategies. **Landscape intervention:** from creating basements for buildings to transitional spaces, plazas, walk paths, to later allocating safe spaces for transportation, services, and infrastructure. Natural landscapes are adapted to prioritize and differentiate uses in the built environment and started by observing and testing resistant materials, water ways, sightlines, and climatic, aesthetical, and operational needs. Modern and contemporary urban and architectural interventions are intentional since they depend on urban configurations to allocate and make buildings accountable, measurable, and accessible. Transportation systems, mostly cars, constitute one of the more invasive interventions. In the site, the owner identified the need for modification to the property's built and natural landscape after at least two years of observations.

## CONCLUSION

Identifying intentional and unintentional design and building elements was a challenge that the research team took and faced with an overwhelming set of results. Facing countless gaps in historical records to confirm the connection between an existent element e.g. a tree, and the intention to use it as a shade in the origins of architecture is a fact. Meaning, we intuitively know that the scenario can be true but, the validation needed to name it a research finding is far from happening. However, the collecting of historical facts around ancient environmental design (AED) reflecting effective bioclimatic performance is proven. Both, the review of literature and the story telling by the sample site owner allowed us to find the true scenario of bioclimatic strategies solving the FEW nexus in two different times and geographical locations. The studies about ancient architecture provided evidence of the validity and agency of ancient environmental design that evolved and is currently influencing contemporary architecture advancement. Greek and Roman cultures have permeated into contemporary design but the bioclimatic approach to design has also emerged from empirical design by nature oriented people. Architecture practice has an opportunity to account for both approaches to environmental design in addition to the academic and field industry set of guidelines, recommendations and certifications. Although technological advances Societies have substituted natural conditions and developed endless ways to create artificial environments to bring comfortable living conditions, regardless of the exterior conditions, the current environmental crisis demands rescuing successful design strategies blended with professional design, historical lessons learned and empirical solutions. As a society, we must learn how to prevent the impacts of future climate warming scenarios. Through observations based on documents and a sample site, we could resonate with the nature of decisions made before and during urban and architectural growth in different locations and ages. The DDN (Daily Dose of Nature), as described by the sample site owner of the site used as a sample site, increased tremendously, along with happiness and connectivity to nature right here at home. We are proud, the owner said, of providing an excellent shelter for humans. Perhaps, the same can be said about the impact of ancient models of architecture that can be documented in endless sources.

## ACKNOWLEDGEMENTS

We want to acknowledge the advice and thoughtful lectures and recommendation of readings of Dr. David Howard Soren, Regents Professor of Anthropology and Classics at the University of Arizona, and internationally known archaeologist and former Vaudeville performer.

## REFERENCES

- A Touch of Rome. 2020. "The Colosseum." Educational. A Touch of Rome. 2020.  
<https://www.atouchofrome.com/colosseum.html>.
- Barnett, R. 2007. "Sacred Groves: Sacrifice and the Order of Nature in Ancient Greek Landscapes." *Landscape Journal*, 26(2), 252–269.
- Cooley, A. E. 2016. *A Companion to Roman Italy*. New Jersey: John Wiley & Sons, Incorporated.

- Eckstein, E., & Bell, C. 1882. *Quintus Claudius; a Romance of Imperial Rome*. New York : W.S. Gottsberger.  
<http://archive.org/details/quintuscladiusr02ecks>.
- Eliasson, O. 2012. *Leer es respirar, es devenir: escritos de Olafur Eliasson*. Translated by Moises Puente. Barcelona: Editorial Gustavo Gili.
- Encyclopaedia Britannica. 2017. "Agora." *Encyclopedia Britannica*. Encyclopaedia Britannica, Inc.  
<https://www.britannica.com/topic/agora>
- Erskine, A. 2009. "A Companion to Ancient History." *Blackwell Companions to the Ancient World*. Malden, Mass.: Wiley-Blackwell.
- Gates, C. 2008. "Cities, ancient and daily life." In D. M. Pearsall (Ed.), *Encyclopedia of Archaeology* (pp. 996–1002). Academic Press. <https://doi.org/10.1016/B978-012373962-9.00007-8>
- Ghisleni, C. 2020, November 25. "What is Vernacular Architecture?" *Architecture news*. ArchDaily. Translated by Tarsila Dudch. <https://www.archdaily.com/951667/what-is-vernacular-architecture>
- Hobhouse, P. 2020, August 31. "We Have Ancient Greece to Thank For Contemporary Gardens." Penelope Hobhouse on the Long-Ago Roots of Naturalistic Wonder [Educational]. *Literary Hub*. <https://lithub.com/we-have-ancient-greece-to-thank-for-contemporary-gardens/>
- Jasiński, J. (No date). "Spectacles in Colosseum [Educational]." *Imperium Romanum*. Accessed January 18, 2021.  
<https://imperiumromanum.pl/en/curiosities/spectacles-in-colosseum/>
- Lechner, N. 2015. *Heating, Cooling, Lighting: Sustainable Design Methods for Architects (Fourth)*. New Jersey: John Wiley & Sons.
- Marconi, C. 2014. *The Oxford Handbook of Greek and Roman Art and Architecture (1st ed.)*. Oxford University Press.  
<http://oxfordhandbooks.com/view/10.1093/oxfordhb/9780199783304.001.0001/oxfordhb-9780199783304>
- Middel, A., Selover, N., Hagen, B. and Chhetri, N. 2016. "Impact of shade on outdoor thermal comfort—A seasonal field study in Tempe, Arizona." *International Journal of Biometeorology*, 60(12), 1849–1861.  
<https://doi.org/10.1007/s00484-016-1172-5>
- Miles, M. M. 2016. *A Companion to Greek Architecture*. John Wiley & Sons, Incorporated, Wiley-Blackwell.
- Nosov, K. 2009. *Gladiator: Rome's Bloody Spectacle*. Oxford: Osprey.
- Nuffida, Nur Endah. 2015. "On Architecture and Energy: The Concept of (Generating) Form through Adaptation." *Procedia - Social and Behavioral Sciences, Green Architecture for Sustainable Living and Environment*, 179 (April): 154–64. <https://doi.org/10.1016/j.sbspro.2015.02.418>.
- Richards, S. 2012. "'Vernacular' Accommodations: Wordplay in Contemporary-Traditional Architecture Theory." *Arq : Architectural Research Quarterly* 16 (1): 37–48.  
<http://dx.doi.org.ezproxy2.library.arizona.edu/10.1017/S1359135512000279>.
- Sheridan, T. 1995. *Arizona: A History*. Arizona: University of Arizona Press
- Soren, D. (2017). *Greek and Roman Art and Archaeology and Their Influence: An Introduction*. (1st ed.). Kendall Hunt Publishing.
- Stillwell, R., MacDonald, W. L. and McAllister, M. H. 1976. *The Princeton encyclopedia of classical sites*. Princeton University Press. <https://openlibrary.org/books/OL5204801M>
- Thommen, L. 2012. *An Environmental History of Ancient Greece and Rome*. Rev. English ed. Cambridge ; New York: Cambridge University Press. <https://ebookcentral.proquest.com/lib/UAZ/detail.action?docID=866907>.
- Ulrich, R. B., & Quenemoen, C. K. 2014. *A companion to Roman Architecture*. Wiley Blackwell.  
<http://ezproxy.library.arizona.edu/login?url=http://dx.doi.org/10.1002/9781118325117>
- Wright, R. L. 1934. *The story of gardening from the hanging gardens of Babylon to the hanging gardens of New York*. Dodd, Mead & Company. [http://hdl.handle.net/2027/uc1.\\$b562237](http://hdl.handle.net/2027/uc1.$b562237)



# Salutogenesis + Design: Pursuing an Architecture of Wellness in an Age of Illness

Brian R. Sinclair<sup>1,2</sup>

<sup>1</sup>University of Calgary, <sup>2</sup>sinclairstudio inc.<sup>2</sup>, Calgary, CANADA

**ABSTRACT:** Over the last century, our planet has become far more urbanized, with cities growing and evolving at unprecedented levels. Undeniably we find society struggling with the many crises that have arrived in recent decades. The complexity of the world, and the incomprehensible scale of some of its problems, calls for new means of understanding and operating. Incremental shifts & minor adjustments, in many ways, prove inadequate to respond to unprecedented challenges. Today's ethos demands dramatic measures, including critically those factors influencing and impacting the health of civilization and the planet it calls home. Salutogenesis presents a method of acting + advancing, in many realms including architecture, whereby people are understood in their fullness. Taking into consideration a plethora of facets affecting our wellbeing, a salutogenic approach shifts the emphasis towards health promotion and away from disease management. Architecture's roles in equations of health & wellness prove both profound and rich in potential. Over recent years, and considering current crises, the architectural profession has been increasingly charged with generating building designs that promote individual wellness + public health. The definitions of health are many and diverse. That said, we are coming to understand with far greater clarity the tremendous correlations between health and the environment. Evidence linking the design of buildings and cities to positive health outcomes is significant. Studies in architecture, environmental psychology, social geography and other fields point to positive implications of well-considered and well-designed environments, including access to light, provision of clean air, incorporation of nature, reduced toxicity of materials, provision of social space, and many other design dimensions. Improved natural light can influence productivity. Views of nature can accelerate healing. Avoidance of harmful chemicals can reduce childhood illness. In many ways, the environmental design professions are now grasping design's potential with respect to heightened health outcomes. Medical sociologist Aaron Antonovsky (1923-1994) postulated, in his 1979 book 'Health, Stress and Coping' that a person's ability to manage and thrive in life's journey was related, in part, to the quality of their environments. Health depends, in part, on the environments which we occupy. Psychologists refer to place attachment and place identity, underscoring the remarkable influence place has in our lives. Upwards of 90% of our time, in many countries, is spent indoors, making the significance of health-promoting buildings even more urgent. Likewise, urban design and city planning are poised to better cultivate health. The present research actively explores Antonovsky's thinking, pushing hard to consider, craft and realize strategies to foster an architecture that is in synchronization with individual and community health needs and aspirations. Deploying critical analysis of the literature, case studies, studio education and logical argumentation, the current research proffers novel, bold and potent ways of linking design to wellness. Charles Jencks (2017) stressed that "Architects and doctors both are committed to creating a better future; they project plans and cures onto the horizon and seek to persuade people of their positive outcomes." Salutogenic design presents alternative ways of seeing, knowing and acting that can place us on a path to greater health in the built environment.

**KEYWORDS:** salutogenesis, architecture, planning, landscape, urbanization, urbanism, systems, holism, quality of life, the city.

## INTRODUCTION

"While we endeavor to provide spaces and places that are functional, durable and dependable, the real magic of design and planning lies in those aspects that move us well beyond. Strong design and planning accept the pragmatic as a given while aggressively pursuing the inclusion of the poetic. It is in this intricate balance of pragmatic and poetic that the spiritual is most likely to manifest. With basic needs realized, users of our spaces and places can then have the opportunity to experience beauty, encounter solitude, attain flow and achieve meaning in ways that enhance emotions, accentuate perception and heighten pleasure."

*Sinclair, 2019*

"I will use treatment to help the sick according to my ability and judgement, but never with a view to injury and wrongdoing. I will keep pure and holy both my life and my art. In whatsoever houses I enter, I will enter to help the sick, and I will abstain from all intentional wrong-doing and harm."

*The Oath of Hippocrates*

Over the last century, our planet has become far more urbanized, with cities growing and developing at unprecedented levels. Concurrently we have witnessed the power of science and technology unleashed to improve the quality of lives for many of the globe's inhabitants. Advancements in medicine, engineering, economics and other fields have dramatically altered, for good and perhaps at times for bad, the ways in which we plan, construct and occupy our urban settlements. While the path of post-industrial progress has been one characterized by optimism in many corners, it has in recent times been altered and challenged in profound ways. Global economic crises, civil unrest, devastating epidemics & pandemics, systemic racism & oppression, intra and international armed conflict, growing income disparity, and climate change, to name but a few forces ushering in disorder, upheaval & unease, loom as incomprehensible problems that we, individually and collectively, must confront. Architecture, Planning + Urban Design, amid such grave and unheralded obstacles, stand as potential & powerful vehicles for realizing positive change in our world.

It is instructive, and humbling, to consider the recent COVID-19 global pandemic in light of architecture and planning, our lack of preparedness, our atrophication, and our inability to cope and respond. Without question design came up short, in part due to a lack of understanding of the links between health and the environment, and in part due to the relatively intransigent nature of our professions. While some argue we could not have foreseen the severity of the coronavirus crisis, in some ways this is a red herring. Good design that fosters good health is good sense, period. In considering the decline of public health globally, and perhaps most notably in North America, architects have missed the critical opportunity to be part of solution. From engineering exercise from our lifestyles (e.g., automobile centric planning), to constructing environments that expose occupants to toxins (e.g., sick building syndrome), environmental design professionals have often failed to address the medical profession's oath 'to do no harm'. Certainly, the health care field now undeniably recognizes the role of the environment in health and wellness equations. The fact that Salutogenesis has, for decades, underscored the importance of design in health promotion, gives us reason to take notice and to begin to shift directions. In architecture education, like in the profession, scant attention is afforded to the physical determinants of health and to the ethical responsibility of design professionals to promote well-being. The present paper examines both the profession, and education, in an effort to highlight the remarkable opportunity we have to alter our strategies, to be proactive in design, and to cultivate + construct environments where health is paramount.

Within the spheres of the building industry, many strides have been witnessed – including emerging materials, structural innovations, smart buildings, performative codes fostering life safety, etc. Further, ongoing research promises to introduce potent inventions into the design and construction sectors, including developments that will impact the ways we conceive, construct and occupy buildings, landscapes, spaces & places. The current research, and associated paper, is concerned with both the application of existing technologies, as well as the experimentation with emerging technologies, with heightened Quality of Life (QoL) front of mind.

Over the past few years, and especially considering current crises, the architectural profession has been increasingly charged with generating building designs that promote health and wellness. The definitions of health are many and diverse. That said, we are coming to understand with far greater clarity the tremendous correlations between health and the built environment. The notion of environmental determinism has serious implications to the ways we approach city building, architecture and interior design. Winston Churchill, in encouraging the rebuilding of Britain following WW2 bombings, noted, "We shape our buildings, thereafter they shape us." Evidence increasingly points to the demonstrable impacts, positive and negative, arising from the ways we design and dwell in the built world. In the education of architects, such facets as environmental psychology, cultural anthropology, public health, neuroscience and medical sociology, must find meaningful places in the curriculum. The studio, as a primary vehicle in the learning process, must anticipate, accentuate, and attend to the health, happiness and well-being of building users. Cultivating good health of those who occupy our spaces, places, buildings and streets is, arguably, both obligation and opportunity. The present paper actively explores the connections and correlations between the ways we design and the outcomes we precipitate.

Societal concerns around environmental crises have been amplified over recent years through increasing deterioration of personal and population health. In part due to modern approaches to the planning of cities, and in part a result of our over-reliance on the automobile, health has been engineered out of our communities. Resurgence editor, and former Jain monk, Satish Kumar has urgently called for an embrace of more integrated tactics that unite the triad of 'soil, soul & society'. With a view to wholeness + holism we refer to the trilogy of Body-Mind-Spirit. It is clear today that the promotion of health and wellness must be at the center of our making and using of cities, buildings, and interiors. Architectural organizations, such as the Royal Architectural Institute of Canada (RAIC) and the American Institute of Architects (AIA) have elevated health concerns and wellness advocacy to crucial levels. The AIA, on the priority afforded to public health, noted: "Architects are uniquely positioned to align human health, climate health, and design thinking to improve lives." Without question Architects have an unprecedented opportunity (and, of course, a connected obligation) to cultivate health – of people, of buildings, of cities and of the planet – through strategic, evidence-based and innovative design. The author accepts this new reality and explores ways in which design can heighten public health, user happiness and societal wellness.

The current research addresses the pressing question of the efficacy of prevailing approaches to health and design, especially considering the growing complexity of problems pertaining to social, physical, economic, cultural, spiritual and other environments. It deploys methods of literature review, critical-analysis and logical argumentation to interrogate the status quo and to consider how Salutogenesis might contribute to more robust and potent ways of dealing with contemporary crises. In the first instance the present research is concerned with the development of theory and to opening doors to new approaches to an emergent area of scholarship.

### 1.0 ILLNESS VERSUS WELLNESS

“Salutogenic design originates from Aaron Antonovsky’s theory of ‘salutogenesis’, developed in 1979. The term translates into ‘health origins’. Essentially Antonovsky, a medical sociologist, focuses on the promotion of active health and wellbeing rather than concentrating on the pathogenic approach that deals solely with resultant disease and injury.”  
*Mazuch (2017)*

“How you can kill a human with an apartment just as well as with an axe.”  
*(Heinrich Zille, 1858-1929)*

Undeniably we find society struggling with the many crises that have arrived in recent decades. The complexity of the world, and the incomprehensible scale of some of its problems, calls for new means of understanding and operating. Incremental shifts & minor adjustments, in many ways, prove inadequate to respond to unprecedented challenges. Today’s ethos demands dramatic measures, including perhaps most critically those factors influencing and impacting the health of civilization and the planet it calls home. Salutogenesis presents a method of advancing, in many realms including architecture, whereby people are understood in their fullness. Taking into consideration a plethora of facets affecting our wellbeing, a salutogenic approach shifts the emphasis towards health promotion versus disease management. Architecture’s role in equations of health & wellness is profound.

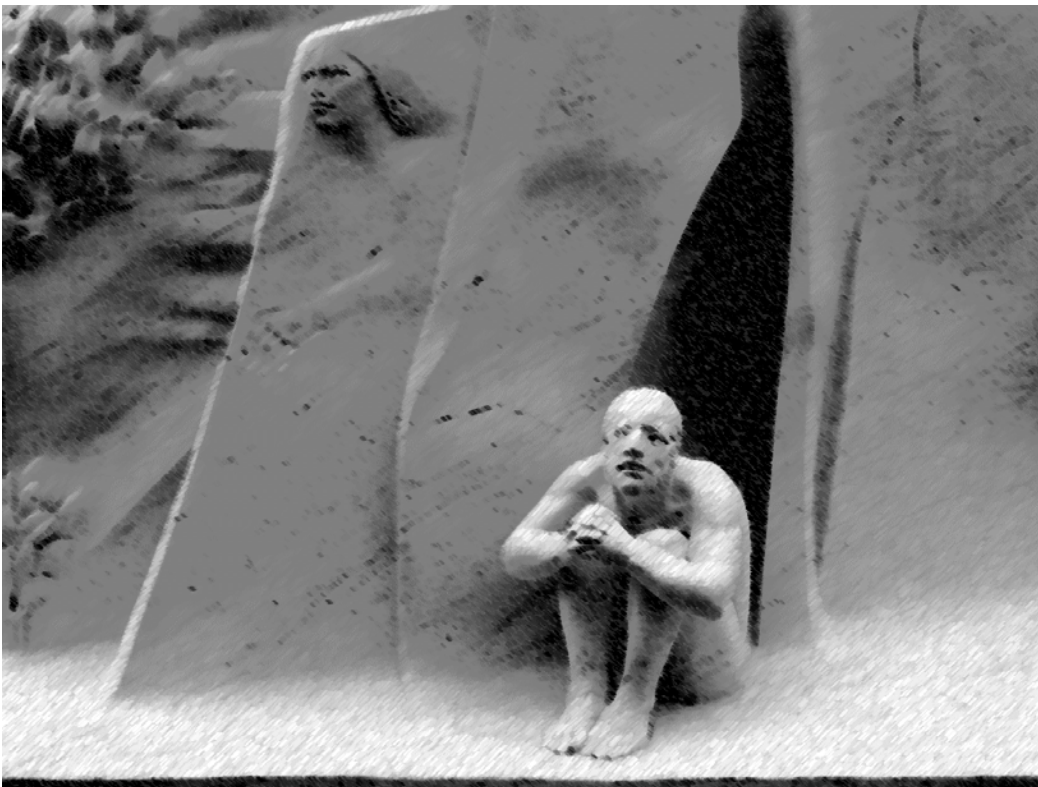


Figure 1: People Reside at the Center of the Built Environment

Evidence linking the design of the built environment to positive health outcomes is long-standing, significant and growing (see for example, classic research including Ulrich 1979, 1983, 1984; Kaplan & Kaplan, 1989, Kaplan, Kaplan & Ryan, 1998; or more recent studies, such as Choi, Merrienboer & Paas, 2014, Peters, 2017, and Lindern, Lymeus & Hartig, 2017). Studies conducted in architecture, environmental psychology, social geography, and other fields point to the positive implications of well-considered and well-designed environments, including access to light, the provision of clean air, incorporation of nature, reduced toxicity of materials, provision of social space, and many other design

dimensions. Improved natural light can influence productivity. Views of nature can accelerate healing. Avoidance of harmful chemicals can reduce childhood illness. In many ways, the environmental design professions are now grasping the potential of better design with respect to health outcomes. Sustainability programs, such as LEED and the Well-Building Standard, now include many aspects that directly connect to the health and well-being of building occupants. Biomimicry, biophilia and other strategies drawn from the study of nature are demonstrably shaping how we design buildings, how we manufacture products, and how we deploy materials.

Medical sociologist Aaron Antonovsky (1923-1994) postulated, in his 1979 book 'Health, Stress and Coping' that a person's ability to manage and thrive in life's journey was related, in part, to the quality of their environments. Antonovsky developed a concept of 'Sense of Coherence' which is at the heart of Salutogenic theory. Sense of Coherence (SOC) comprises three components: Comprehensibility (cognitive coping), Manageability (problem solving) and Meaningfulness (emotional connection). Each of us resides on a health-disease spectrum -- we move around between the poles based on many factors, including individual qualities (such as predispositions, attitudes, immune responses, etc.). Nothing is static within the equation, including our reactions and responses to pressures and stressors. Within our ethos are multiple parameters, both positive and negative, that influence our position on the health-disease spectrum. Some stress is positive and can benefit wellness, while other stress is negative with often debilitating consequence. Over recent years researchers have demonstrated strong links between the container (environments) and the contained (users). The nature of the container, including design's ability to uplift or oppress, is now understood as a key factor influencing physiology, psychology, sociology and so forth. Some examples are easy to understand -- for example asbestos and cancer, or stagnant water in air handling equipment and respiratory illness. Other linkages, due to levels of abstraction, are more challenging -- for example, reductions in access to natural light and impacts on mental health. In some jurisdictions, Europe for example, connections between health and the environment have led to policy enactment -- such as the 'right to light' legislation. However, despite growing evidence bridging health and design, the profession has been slow to act. Things are beginning to shift, in part due to the dramatic cost implications of turning a blind eye (e.g., obesity's rising impact on the health care price tag globally). Awareness of design's potential to impact quality of life seems to be on the rise. Architects and psychologists refer to place attachment and place identity, underscoring the remarkable influence place has in our lives. In North America, and especially in northern regions, typically upwards of 90% of our time is spent indoors, making the significance of health-promoting buildings even more urgent. There is little question that the links between environment and behavior, and between architecture and well-being, are demonstrable and profound. An excellent overview of such connections is delineated in the seminal open access publication, *The Handbook of Salutogenesis* (Springer 2017), including a comprehensive chapter addressing the built environment (see Lindern, Lymeus & Hartig: *The Restorative Environment: A Complementary Concept for Salutogenic Studies*). The present paper actively explores Antonovsky's thinking and writing, as well as literature in the area, pushing hard to realize architecture that is in synchronization with individual and community health needs and aspirations. Charles Jencks (2017) stressed that "Architects and doctors both are committed to creating a better future; they project plans and cures onto the horizon and seek to persuade people of their positive outcomes."

Over recent years, and considering current crises, the architectural profession has been increasingly charged with generating building designs that promote individual wellness + public health. Humans employ a wide range of technologies and systems in their creation and modification of environments; included in this are the many technologies involved in the design, construction, and inhabitation of buildings and their related environments. The design of a building, including interrelationships with context (site, climate, regulatory structures, customs, etc.), must be considered through the intertwined development of spatial, cultural, psychological, structural, enclosure, environmental and other crucial systems. In many ways, the environmental design professions are now grasping design's potential with respect to heightened health outcomes. Salutogenic design, as one particularly novel, pertinent, and efficacious tactic, presents alternative ways of seeing, knowing and acting that can place us on a path to greater health in the built environment.

## 2.0 FROM PEDAGOGY TO PRACTICE

"We perceive atmosphere through our emotional sensibility – a form of perception that works incredibly quickly, and which we humans evidently need to help us survive. Not every situation grants us time to make up our minds on whether we like something or whether indeed we might be better heading off in the opposite direction. Something inside us tells us an enormous amount straight away. We are capable of immediate appreciation, as spontaneous emotional response of rejecting things in a flash."  
*Zumthor (2010)*

"Asking why architects matter leads to two related answers. The first is about their intrinsic value to society as creators of healthy, safe, and beautiful buildings and spaces. This value is unchanging and impervious to recessions or depressions (or viruses, for that matter). The second is about the relative value of architects to clients, particularly during an economic and public health crisis."  
*American Institute of Architects (2020)*

To explore, and perhaps advance thinking and implementation of Salutogenesis in Architecture, the author developed and taught a graduate health and design studio. The primary goal of the studio was to build in students an awareness of and facility with notions of environmental, social, and other determinants of health. It is argued, considering an examination of accreditation criteria in Canada and the United States, that limited attention is directed to the inclusion of environmental psychology and research acumen within the curriculum of most architecture programs (see Sinclair, 2020). The studio under consideration in the present paper presents a dramatic departure from the focus on architecture as object and building as sculpture, instead pivoting to user-centric design and health-oriented outcomes. A related objective was to explore the roles design might play in fostering health, promoting wellness, and supporting happiness. Beyond building as object and architecture as sculpture, the studio sought to more directly link human behaviour to the built environment, with a proposition that good design can translate into health promotion and healthier people.

Studio education is unique in many aspects, including through its deep immersion, its creative dimensions, its deployment of iteration and its willingness to consider the unconventional. In the Health + Design studio, 14 Master of Architecture students were charged with developing 14 distinct solutions on 14 different sites within Calgary's (located in Alberta, Canada) inner city. Focusing on four prominent streets linking the downtown to the Trans-Canada Highway (16<sup>th</sup> Avenue North), the sites were situated in a realm of the in-between. Not downtown and not suburbia -- rather, intermediary zones with mixed commercial uses buffered by established residential communities. Students formed in four teams critically analyzed these four inner city arterials, with a goal to characterize the fabric, delineate the demographic, explore potential and provide a sense of DNA. As part of the group work, each team member needed to also select a site for their own project.

The term project was a 5000 M2 facility that combined a 3000 M2 Salutogenesis Institute with a 2000 M2 arts & creativity center. Students had significant latitude in setting the directions for the arts and creativity center, as well as broad abilities to shape and define the relationships between the salutogenic and arts facets of the project. Each project found its own proportions, dynamics, and equilibrium with respect to programmatic pursuits and architectural responses. Assignments in the opening weeks of studio included individual site analysis and program development.

Pedagogically the studio invoked an unconventional posturing, whereby an intense research stage (Phase 2 - one month | October 2020) followed an opening conceptual design effort (Phase 1 - one month | September 2020). The notion was to encourage students in the opening stage to push ahead with some design explorations with an intuitive grasp of principles around health & design. Following Conceptual Design Reviews at the end of Phase 1, the studio dramatically pivoted into research modes whereby key aspects of health, design and architecture were critically examined. This phase included a workshop with experts drawn from medicine, building science, indigenous culture, and innovation. Research work was undertaken by students, working in teams, and specifically studying four themes within an umbrella of 'change + changeable': 1. Agile Architecture | Open Building | Flexible Design | Design for Disassembly; 2. Regenerative Design | Resilient Design | Restorative Design | Sustainability; 3. Re-Orienting from Pathos to Prevention | Alternative Medicine | Salutogenesis; 4. Disruptive Innovation | Catalysis | Creative Destruction | Systems + Cybernetics. Research reports were prepared and presented as part of the learning objectives, with feedback provided by several Master of Environmental Design thesis students.

Operating with newly acquired knowledge, and informed by evidence, students then revisited their conceptual designs with a goal to re-consider how space and form might be better connected to user experience, health and wellness. This design push gained benefit through consideration of the power and potential of landscape, informed and inspired through an afternoon and interactions with a leading Landscape Architect. Phase 2 of the studio incorporated research and re-redesign, culminating in Design Development Reviews. The final component, or Phase 3, of studio was directed to revision, refinement and representation of architecture. In this last stage of studio, students were charged with examining and advancing modes of representation that would serve to communicate their building & landscapes in ways that underscored connections of health + design, that would effectively sell their research ideas to others, and that would convincingly convey the 'spirit of place' of their semester-long design project. The Final Reviews for the Health + Design studio, demonstrated the efficacy of the pedagogy and served to underscore the value of pursuing architecture that aims to optimize the role human-made environments can play in fostering better health and cultivating wellness at both individual and population scales.

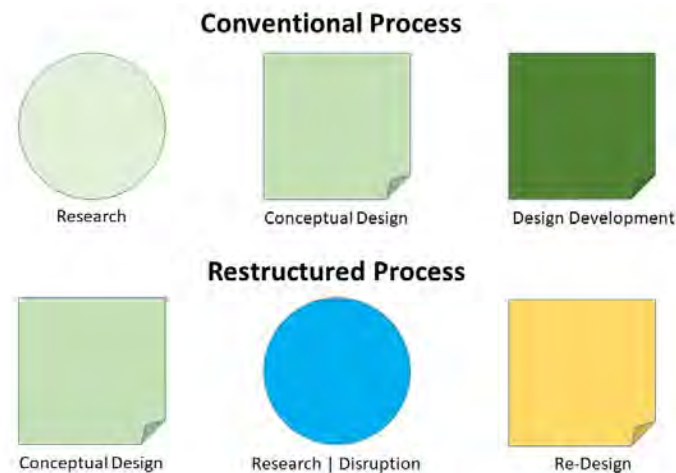


Figure 2: Inverted Health + Design Studio Process

While the studio was conducted within the confines of an accredited school of Architecture, the end goal was of course to have students become professionals who clearly grasp their roles and responsibilities to ensure healthy environments and well populations. In many ways societal understanding of the correlations between disease and the environment has been understood over time, most notably in highly explicit cases such as those involving chemicals in water supplies, toxins in homes, radiation from nuclear sources, and so forth. However, a superior and more meaningful understanding between the built environment and our wellness has been slower to arrive, in part due to more subtle and less dramatic relationships -- for example access to daylight and improved learning, or proximity to nature and improved healing, or availability of fresh air and improved respiration. With increased attention now being afforded to such dimensions of our interiors, buildings, communities and cities comes rich opportunities for architects and associated environmental designers to heighten their efficacy, increase their value, improve their reputations, and, most importantly, enhance quality of life (QoL). While the present paper has underscored one case (i.e., health + design studio) within higher education, the author emphasizes the need for much wider, much deeper and much more aggressive efforts to ensure design and health are thoughtfully bridged, rigorously studied, effectively taught and measurably advanced. At present many schools of architecture fail to highlight the undeniable connections between design and behavior, with limited reliance on evidence-based design and the deployment of established knowledge (from architecture and beyond) in determining appropriate choices on space, form, materiality, acoustics, lighting, air quality, phenomenological aspects, to name but a few parameters at play. The studio case in question is the first of a series of health-oriented studios that will be studied over time, with a goal to critically assess pedagogy and learning outcomes. Informal feedback from students and reviewers, to date, points in positive directions whereby values shift from the building as construct to the user as consumer. It is argued that the definitions of excellence in architecture and design must move beyond aesthetics to embrace impacts on occupants, health, safety, wellbeing, and wellness.

### 3.0 HOLISM + HEALTH

*“Leveraging the design process to achieve measurable health outcomes, each reveals architecture’s broader potential to promote sustainable physical, emotional, social, economic or environmental health.”*  
Murphy & Mansfield (2017)

*“Appropriate solutions to some of our most daunting problems will arise through the concerted efforts, open dialogue, and collective wisdom of the wide array of stakeholders, professionals, politicians, decision makers, and citizens (both engaged and disenfranchised) who have the will and wherewithal to make a difference and to make the world safer, healthier, and better. It seems vital for us to critically examine, and question, our belief systems and their connections to the ways we define, refine, and realize progress.”*  
Sinclair (2015)

While the Salutogenesis approach is well known in medical circles, it is largely absent in spheres of architecture, landscape, and planning. Salutogenesis, as a theory, directly involves and implicates the built environment as a major factor in our health and wellness. As was noted, within design education such connections, yet alone symbiotic opportunities, are seldom realized. The present researcher, an architect and psychologist, has long promoted a more holistic, human-centric, and health-oriented model for design and planning. The Holistic Framework for Design + Planning (Sinclair, 2015) presents a unique complement to Salutogenic Theory, underscoring the need to consider peoples’ needs in much more comprehensive, inclusive, and equitable ways. In many ways, including both philosophically and operationally, the Holistic Framework finds resonance with Salutogenesis. Design must embrace



both quantitative and qualitative dimensions, including a willingness to pursue aspects of living, working, and dwelling that are not easy to measure. For example, the incorporation of 'Delight' as a key feature of the model celebrates the importance of joy and happiness in our journeys, yet arguably proves daunting to tally, count, and consider. That said, the model is about provocation before prescription, and dialogue above determinacy. The goal of the framework is to precipitate critical thinking with the equation as design advances on any given project -- whether interior design, architecture, landscape, urban space, or city planning. A holistic approach promotes a more robust consideration of user needs and permits a broader conversation of the implications of design, most vitally around improved Quality of Life (QoL).



Figure 3: Sinclair Holistic Design + Planning

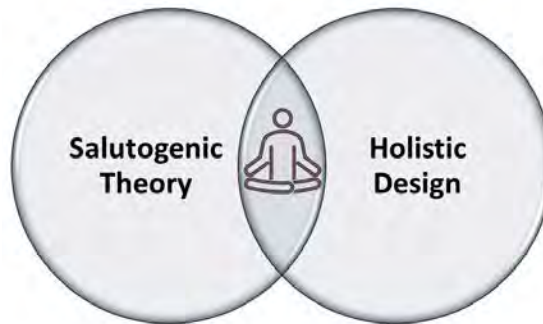


Figure 4: Synergies - Salutogenesis + Holism

Architecture, both within the halls of education and in the offices of practice, has been relatively slow to dive into investigation and application concerning the determinants of health. However, as research demonstrates (often arising from outside of the environmental design fields) there are demonstrable relationships between design, behavior, health, and happiness. The author contends that more attention must be afforded to these key issues within both schools of architecture and professional firms. Society is increasingly cognizant of the culpability of design and construction in many realms, including contributions to landfills, energy consumption, water utilization, green house gas emissions, and increasingly impacts of our health. Research (Sinclair 2020) points to glaring deficiencies in architectural education, including in areas pertaining to environmental psychology and research training. If curricular gaps can be filled, then the profession will see traction with respect to evidence-based decision making, improvements in user wellness, and heightened public health. Without question the global pandemic has placed great attention on the built environment. The British Prime Minister Winston Churchill once cautioned, "Never let a good crisis go to waste". While COVID-19 has set off some vital alarms to the world, the environment design professions have a remarkable opportunity to not only address short-term calamities, but also to raise up the profession in terms of its values and value, and to make extraordinary contributions to the betterment of communities across the planet. The current pandemic was not the first and will not be the last. Crises will escalate in number and severity moving forward, and, as such, the architecture profession must be well-prepared to respond and well-equipped to react. The present paper considers on strategy, namely Salutogenesis, whereby the education of professionals and the conduct of professions, can be migrated away from an aesthetic emphasis and towards a user-impact model. To realize serious change in the system, professional values must be re-evaluated, professional education must be revised, and professional practice must be re-aligned.

#### 4.0 SYNOPSIS

*"Interweaving of humanist principles and architectural design appears to be a fruitful and optimistic path for designers."*  
Lyon (2017)

*"Through a growing capacity to tolerate uncertainty, vagueness, lack of definition and precisions, momentary illogic and open-endedness, one gradually learns the skill of cooperating with one's work, and allowing the work to make its suggestions and take its own unexpected turns and moves."*  
Pallasmaa (2009)

In our contemporary times the picture can, at times, be bleak and dark. Architecture, as a means and an end, provides optimism into the equation -- proffering a path that can support us as we dwell in cities, interact as people, pursue our dreams, and push for a better tomorrow. The health + design studio sought to build awareness in students of the power of design to buttress our journeys in realms physiologically, psychologically, sociologically, culturally and spirituality. Through the engagement of research and the utilization of evidence, coupled with the creativity and innovation inherent in design, students endeavored to reveal ways in which architecture can contribute to health and happiness. Questing for greater sustainability, incorporating natural systems, harvesting daylight, attending to materiality, accommodating diversity, seeking equity, and pushing for symbiosis of people and place, design through Salutogenesis can serve to illustrate the potential for architecture to change our lives in positive and profound ways. Beyond buildings as malignant or even benign constructions, architecture must transcend from 'doing no harm' to proving restorative. Linden, Lymeus and Hartig (2017) noted that, "Both theoretically and practically, work with restorative environments can complement work guided by a stress perspective on adaptation that focuses on demands from the environment and ways of minimizing and mitigating them. Work concerning restorative environments thus shares with Salutogenesis studies a positive perspective on circumstances that promote health, effective action and well-being." Salutogenesis, along with other more holistic, interdisciplinary and inclusive methods, can serve as vehicles through which the objective and subjective could coexist, the intuitive and the rational could harmonize, and the head and the heart could marry. We need to navigate some uncharted waters with honesty, with courage, and with both skill and grace. The present research aspires to reconsider health & wellness, and their dynamic and vital connections to design and architecture, in novel, resourceful and potent ways. The author calls for open-mindedness, rigor and ingenuity as bridges are constructed between the ways we design and the ways we occupy buildings, landscapes, and the city. In some respect the trek represents a willingness to take risks and to engage in experimentation. Given the current and contentious situations on our doorstep, locally and globally, pursuing different methods, mindsets, tool and techniques for design, with people at the core, proves paramount. The challenges we confront must be met with talent, creativity, cooperation and resolve that together hold promise to improve a world in dire need of care.

## REFERENCES

- Antonovsky, A. (1979). *Health, stress, and coping*. San Francisco: Jossey-Bass.
- Antonovsky, A. (1987). *Unraveling the mystery of health: How people manage stress and stay well*. San Francisco: Jossey-Bass.
- Choi, H. H., van Merriënboer, J. J. G., & Paas, F. (2014). Effects of the physical environment on cognitive load and learning: Towards a new model of cognitive load. *Educational Psychology Review*, 26 (2), 225–244.
- Jencks, Charles. "Maggie's Architecture: The Deep Affinities Between Architecture and Health". In *Design for Health: Sustainable Approaches to Therapeutic Architecture*. Editor: Terri Peters. *Architectural Design*. No 146, March/April 2017. Pp 66-75
- Kaplan, R., & Kaplan, S. (1989). *The experience of nature: A psychological perspective*. New York: Cambridge University Press.
- Kaplan, R., Kaplan, S., & Ryan, R. L. (1998). *With people in mind: Design and management of everyday nature*. Covelo, CA: Island press.
- Linden, Eike von, Lymeus, Freddie, and Hertig, Terry. *The Restorative Environment: A Complementary Concept for Salutogenesis Studies*. In M. B. Mettelmark et al (eds), *The Handbook of Salutogenesis*. Springer: Open Access. 2017. Pp 181-195.
- Lyon, Corbett. "Humanistic Principles, Sustainable Design and Salutogenics". In *Design for Health: Sustainable Approaches to Therapeutic Architecture*. Ed: T Peters. *Architectural Design*. No 146, March/April 2017, p 56-65
- Mazuch, Richard. "Salutogenic and Biophilic Design as Therapeutic Approaches to Sustainable Architecture." In *Design for Health: Sustainable Approaches to Therapeutic Architecture*. Editor: Terri Peters. *Architectural Design*. No 146, March/April 2017. Pp 42-47
- Mittelmark Maurice B., Sagy Shifra, Eriksson Monica, Bauer Georg F., Pelikan Jurgen M., Lindstrom Bengt, Espnes Geir Arild (Editors). *The Handbook of Salutogenesis*. Springer: Open Access. 2017.
- Murphy, Michael and Mansfield, Jeffrey. "Can Architecture Heal: Buildings as Instruments of Health". In *Design for Health: Sustainable Approaches to Therapeutic Architecture*. Editor: Terri Peters. *Architectural Design*. No 146, March/April 2017. Pp 82-89
- Peters, Terri (Editor). *Design for Health: Sustainable Approaches to Therapeutic Architecture*. *Architectural Design*. No 146, March/April 2017.
- Sinclair, B. R. 2009. *Culture, Context, and the Pursuit of Sustainability*. Cover Article in *Planning for Higher Education (PHE) Journal*. Issue #38, October-December 2009. Pages 6-22.
- Sinclair, Brian R. "Integration | Innovation | Inclusion: Values, Variables and the Design of Human Environments". *Cybernetics and Systems: An International Journal*, 46:6-7, 2015. Pp 554-579.
- Sinclair, Brian R. "Spirituality and the City". Book chapter: *The Routledge International Handbook of Spirituality in Society and the Professions*. Ed. Laszlo Zsolnai, Bernadette Flanagan. Routledge: Oxon, UK. 2019, p 93-102.
- Sinclair, Brian R. *AWOL: psychology, business + research in contemporary architectural education*. EAAE-ARCC European Association of Architectural Educators | Architectural Research Centers Consortium 2020 International Conference. Valencia, Spain. 2020
- Ulrich, R. S. (1979). Visual landscapes and psychological well being. *Landscape Research*, 4(1), 17–23.
- Ulrich, R. S. (1983). Aesthetic and affective response to natural environment. In I. Altman & J. F. Wohlwill (Eds.), *Behavior and the natural environment* (pp. 85–125). New York: Springer.
- Ulrich, R. S. (1984). View through a window may influence recovery. *Science*, 224(4647), 224–225.
- Zumthor, Peter. *Atmospheres: Architectural Environments, Surrounding Objects*. Birkhauser: Basel, Switzerland 2006

# A Framework for the Integration of CFD into the Early Stages of Architectural Design

Soo Jeong Jo<sup>1,2</sup>, James Jones<sup>1</sup>

<sup>1</sup>Virginia Tech, School of Architecture + Design, Blacksburg, Virginia

<sup>2</sup>Louisiana State University, School of Architecture, Baton Rouge, Louisiana

**ABSTRACT:** Computational Fluid Dynamics (CFD) refers to computational methods to predict the movement of fluids. Although CFD can be helpful in predicting airflow in relation to architectural design, the users of CFD in the building industry tend to be limited to researchers and consulting engineers. It may be desirable to make CFD analysis more accessible to architectural designers throughout the whole design process. However, the current literature related to CFD implementation in architecture mostly focuses on a single domain of decision-making rather than the comprehensive design process. The present study aims to show how CFD and other alternative simulation tools can be utilized throughout the architectural design process and how the airflow simulations can interact with the dynamics of design thinking. This research suggests an implementation framework that can be expanded to different architectural projects while supporting architectural designers to utilize CFD simulation in the early stages of design. To achieve this goal, a design project was selected and developed. Airflow simulations were conducted for each design step, and the details of the simulation process were followed. Furthermore, the design decision-making processes in interaction with the CFD simulation results were observed and documented.

**KEYWORDS:** CFD, Architecture, Design, Building Performance Simulation, Early Stage

## INTRODUCTION

Computational Fluid Dynamics (CFD) refers to computational methods to predict the movement of fluids. Due to its efficiency when compared to modeling methods such as scale models in a wind tunnel, CFD has been widely used since the 1970s in various fields including aerospace engineering and the automobile industry. More recently, it is being applied to architecture since airflow analysis has become an important issue in the architectural design process (Jo, Jones, and Grant 2018). Furthermore, the shapes and the interior layouts of many modern buildings have become complex, making it difficult to intuitively predict airflow in and around a building. Although CFD can be helpful in predicting airflow in relation to architectural design, the users of CFD in the building industry tend to be limited to academics and researchers. In current practice, architecture firms generally outsource CFD analysis to experts for only certain projects that have critical issues related to airflow. It may be desirable to make CFD more accessible to architectural designers throughout the whole design process. In response to this, researchers and software vendors are currently attempting to expand the role of CFD to the early stages of architectural design in which many of the key design decisions are made. However, the current literature related to CFD implementation in architecture mostly focuses on a single domain of decision-making rather than the comprehensive design process. In addition, the implementation of CFD is often for later stage design development and not for early concept generation. The present study aims to show how CFD can be utilized throughout the architectural design process and how the airflow simulations can interact with the dynamics of early-stage design thinking. In addition, other airflow simulation methods that can be an alternative to CFD in the process were explored. This study suggests an implementation framework that can be expanded to different architectural projects while supporting architectural designers to utilize CFD simulation in the early stages of design. To test the framework, an architectural project was purposefully selected. Airflow simulations were conducted for each design step by using different simulation platforms, and the details of the process were followed using a reflective practitioner approach. The design decision-making process in interaction with the airflow simulation results were observed and documented.

## 1.0 FRAMEWORK FOR SIMULATION-BASED ARCHITECTURE DESIGN

Architecture projects start with site/climate analysis and continue to site planning, massing, space planning, and façade design. In each stage of design, architectural designers test their ideas with various representation methods for making design decisions. Airflow simulations can be utilized as one of the representation methods and support architectural designers to develop natural ventilation or wind protection strategies. The simulations for each stage of design should be approached differently because the characteristics of the phases, such as the design scale, focus, and goals require different types of simulation tools and methods. For example, a site design is studied on a large scale focusing on climate and urban context, while a façade design is studied on a reduced scale concentrating on the openings,

overhangs, materials, and enclosure systems of the building envelope. Considering these characteristics, the following sections discuss the simulation strategies for different stages of architectural design.

### 1.1 Climate Analysis

Site Analysis is an integral part of architectural design, which is crucial for developing environment-friendly design strategies. Collecting the climate data, including the information on wind, is particularly important for preparing airflow simulations. Climate Consultant software developed by the University of California, Los Angeles (UCLA), is a useful resource to find and organize the climate data of the project site. It allows the users to plot the climate information of a specific city and represent the information in connection with passive design strategies (Milne et al. 2009). The wind information of the site can be found from the wind wheel offered by Climate Consultant. The wind wheel shows the speed, direction, temperature, relative humidity, and duration of the site wind. However, the lack of microclimate information would be a limitation of Climate Consultant. The climate data provided by the software are from the weather stations, usually located in an open field. Therefore, the data may be accurate if the project site is an open field, whereas a complex urban area with surrounding buildings may need further investigation on the microclimate. A long-term site measurement would provide the most accurate information, but the required time and cost are the limitations of this option. Alternatively, CFD simulations can be employed to predict the microclimate of the site. ENVI-met, developed by Bruse and Fleer in 1998, is one of the widely used software with CFD features that offer the temperature, humidity, global radiation, and airflow simulations of an assigned outdoor area. Salata et al. (2016) stated that this software is the most commonly used tool for studying microclimate in architecture and urban planning research, and Toparla et al. (2017) reported that about 50% of their investigated studies employed this software.

### 1.2. Site planning

For designing a site plan, architectural designers develop the land use scheme that becomes the guideline to place buildings and landscape features on the site. In this stage, airflow simulations may assist the designers in evaluating the pedestrian comfort of the proposed site plan. A high pedestrian comfort level can be achieved by setting the design goal and strategies based on the climate. For example, a high-wind region may need a strategy to mitigate the wind, whereas a hot and humid region may need to induce an airflow for natural cooling and dehumidification. To develop these strategies, the quality of the site wind should be identified first based on the standards. The Beaufort wind force scale is one of the well-known standards categorizing the levels of pedestrian comfort in different wind speeds. After setting the pedestrian comfort goal based on the Beaufort scale, the site design options can be tested with airflow simulations to verify whether the design meets the goal. For example, Blocken and Persoon (2009) studied the wind environment after adding new high-rise buildings to a stadium area. Urban-scale CFD simulations often require an extensive amount of time and a high-performance computer due to the vast size of the computational domain. Therefore, a strategy to mitigate these requirements while minimizing the inaccuracy should be developed for the configuration of the simulation. The best practice guideline by Franke et al. (2007) and the Architectural Institute of Japan (AIJ) guideline by Tominaga et al. (2008) are the widely known references for the urban-scale simulations. Moreover, Blocken et al. (2012) developed a decision framework for outdoor airflow simulations utilizing a case study of the Eindhoven University campus, and Wu and Kriksic (2012) suggested a framework to apply local climate data to CFD simulations.

### 1.3. Massing

Massing refers to a formative design stage in which the overall shape of the building is determined such as the composition of volumes, the building size, and the form of roofs or walls. CFD simulations in this stage may be used for shaping the building structure to resist the wind loads, testing the resistance of the roof to the wind uplift, and inducing or mitigating airflow with the building form. For example, Abohela et al. (2013) used CFD for simulating the airflow around the different shapes of the roof. Roy and Bairagi (2016) investigated a whole building form, specifically a step-shaped building. They conducted CFD simulations for a typical rectangular building and a step-shape building, then compared the simulated airflow around the buildings. Similarly, Blocken and Carmeliet (2008) performed airflow simulations to determine the form of high-rise residential buildings to ensure a safe wind environment for pedestrians. Expanding the focus to complex building forms, Kim et al. (2011) developed a GA to optimize a building shape for improving the pedestrian wind comfort on the site. The turbulence models used in the investigated studies were all RANS, k- $\epsilon$  model, including one study that used both RANS and LES. For the type of the grid, 50% of the studies employed hexahedral cells, while another 50% of the studies were using tetrahedral cells. Although hexahedral cells are generally considered more accurate, tetrahedral cells perform better with complex geometries. Therefore, it is recommended to select the grid type depending on the complexity of the geometry and the simulation goal.

### 1.4. Interior space planning

For planning the interior space of a building, the composition of interior rooms and the characteristics of each space are determined. Based on this process, the ceiling heights of the rooms and the location of partition walls, doors, and openings, which highly affect the direction of the airflow inside the building, are also determined. Airflow simulations in this stage may support architectural designers in developing natural ventilation strategies utilizing the wind or thermal differential pressure. Based on the natural ventilation strategies, architectural designers may determine or evaluate the

depth, orientation, and spatial form of a room. For instance, Wu, Yang, Tseng, and Liu (2011) conducted CFD simulations to improve the space plan of the Tjibaou Cultural Center building and found that the simulated airflow direction inside the building was different from the architect's intention. Based on the simulation results, they suggested additional openings in the area between the hut and the low-level space for changing the airflow direction. Ray, Gong, Glicksman, and Paradiso (2014) investigated a stack effect in an atrium by using CFD. Since a stack effect is a heat-induced airflow, the simulation inlet boundary condition was thermal pressure instead of wind velocity used in wind-induced airflow simulations. They also conducted a study about the accuracy of turbulence models comparing RANS  $k-\epsilon$ , LES models, and experimental data. Similarly, Hooff et al. (2017) focused on the turbulence models for indoor airflow simulations using CFD. With a literature review of 42 relevant articles, they found that 81% of the investigated articles employed RANS and reported that using LES increased the computational demand by 80 – 100 times for performing their simulations. Responding to the time constraints of CFD specifically for large-scale complex buildings, researchers suggest the multi-zone method as an alternative. In this method, each zone or room is a node connected with other nodes through openings between the spaces (Tan and Glicksman 2005). Unlike CFD, the multi-zone method does not require precise input on the thermo-fluid boundary conditions, which often increases the required simulation time (Chen et al. 2010). This simplification makes the method more user-friendly and reduces the processing time even though the output is only the averaged airflow and temperature distribution, not representing precise information as CFD. Chen et al. (2010) claimed that the multi-zone model is the best fit for a whole-building simulation with multiple zones, while CFD is suitable for investigating the detailed airflow and temperature information in one zone. CONTAM, developed by the National Institute of Standards and Technology (NIST), is a well-known software for airflow simulation using this multi-zone method. CoolVent, developed by the Massachusetts Institute of Technology (MIT), is another software using the multi-zone model, and the thermal analysis is additionally coupled here.

### 1.5. Façade design

The shape, size, and location of the openings and overhangs, which directly impact the airflow between outside and inside spaces, are determined when designing the facades of buildings. Architectural designers may use CFD in this stage to design the airflow in interaction with the façade components, such as windows, doors, canopy, and shading devices. For example, Yuan et al. (2019) developed a vertical farm façade design using CFD. They compared six design options with different vegetable block ratios, species, and arrangements and examined the influences of each component on the natural ventilation performance of the façade. Kosutova et al. (2019) investigated the impacts of louvers and the location of openings on the cross-ventilation performance of a building façade and found that the louvered opening at the center of the façade had the best air exchange rate. These studies employed hexahedral grids, and their prevalent turbulence models were RNG  $k-\epsilon$  and SST  $k-\omega$  models. The inlet boundary conditions for the simulations were varied, mostly wind velocity with logarithmic law or a uniform velocity depending on the case. In the simulations with buoyancy effects such as a solar chimney or high-ceiling space, the thermal pressure was used for the inlet boundary condition. For avoiding complexity and obtaining quick results, COMFEN may be an alternative to CFD for measuring the natural ventilation performance of a building façade. COMFEN is a building performance simulation tool developed by the Lawrence Berkeley National Laboratory (LBNL). This tool aims to support decision-making processes in the early stages of design, particularly focusing on building facades and fenestration (Hitchcock et al. 2008). COMFEN does not generate the detailed distributions of air velocity or pressure as CFD does. However, it calculates the thermal behavior of the fenestration and the thermal comfort of the users in a timely manner.

## 2.0. IMMERSIVE CASE STUDY

The proposed framework was tested with an immersive case study. The project for this study was a modular housing complex developed for providing affordable houses and communities for single-family households. The housing complex is a combination of different unit types, which may achieve the diversity of the design despite the modular and prefabricated construction system. The individual unit size was minimized to reduce the construction cost, while the community space accommodated shared kitchens and community living rooms. Figure 1 shows the axonometric view of this project. The roof shape may affect the amount of energy generated with the photovoltaic (PV) system installed on the roof and creates an upper occupied zone for the mezzanine. For example, a shed roof with a low angle can maximize the energy generation from the PV system during summer since the low installation angle is nearly perpendicular to the high summer sun altitude angle. Moreover, the various opening types of the units may have different levels of privacy and thermal performance. For instance, a tilted wall may function as a sunshade protecting the unit from south sunlight. Once the roof and façade design decisions are made, the units are assembled and form a two-story residential complex. The present study observed the design decision-making process of this modular housing project following the framework proposed in the previous section under the scenario that the project would be developed in Baton Rouge, Louisiana.



**Figure 1:** Axonometric view of the modular housing project. Source: (Author 2021)

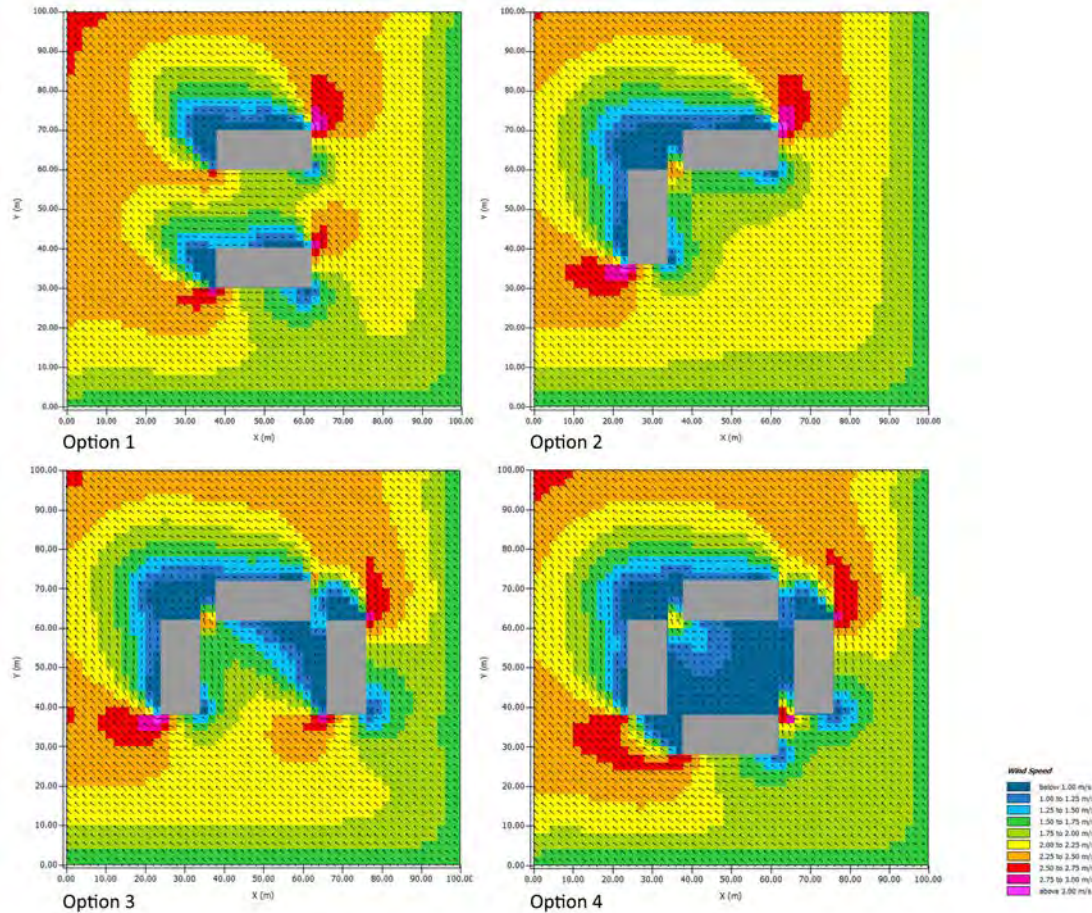
## 2.1. Climate Analysis

The climate of Baton Rouge was analyzed to establish the thermal comfort goal by utilizing Climate Consultant. According to the International Energy Conservation Code (IECC), the climate zone of Baton Rouge is 2A, a hot and humid climate, in which cooling and dehumidification are critical issues. The 51.7% of the time in August, which is the hottest month of the area, requires both cooling and dehumidification. Based on this information, a thermal comfort goal was set to maximize airflow for cooling and dehumidification. After setting the goal, the wind information during the applicable period was collected using the wind wheels generated by Climate Consultant. This information includes the prevailing direction, velocity, temperature, and humidity of the wind. Since these data typically vary with the season or time of the day, it is recommended to specify the data collection period. In this project, August afternoons were selected for the simulation since they have high temperature and humidity issues that can be mitigated with natural ventilation and outdoor airflow. The information from Climate Consultant indicates that the southeast wind temperature is in a comfort range (69°F ~ 81°F), whereas the wind temperature from other directions is in a higher range (81 °F ~ 100°F) than the desired temperature. The southeast wind blows about 10% of the time in August. The microclimate simulations in the next section aimed to decrease the temperature and humidity of the courtyard utilizing this southeast wind.

## 2.2. Site planning

After determining the prevailing wind direction from the climate analysis, further details of the project site and various site design options were studied. Figure 2 demonstrates the wind direction vectors and the velocity distributions in the four site design options. The blue area represents “calm” and “light air” status, while the green, yellow, orange, and red areas represent “light breeze” according to the Beaufort Scale. The simulation results showed that the courtyard in Option 2 had the largest area with the breeze when the incoming wind blew from the southeast. Option 1 also exhibited a higher air velocity, although the south of the courtyard slightly had a stagnant area. Similarly, the southwest of the courtyard in Option 3 had a breeze area, whereas the northeast of the courtyard had a stagnant area. The courtyard in Option 4 had low air velocity overall since the four buildings surround the courtyard. Therefore, the courtyard in Option 4 had the least area with the natural breeze. The temperature of the courtyard was the lowest in Option 1 and the highest in Option 4. The simulation results indicate that the open types of site design such as Option 1 or Option 2 may be better solutions for maximizing airflow and decreasing the air temperature. If the users require more privacy, Option 3 may be the solution that meets both the privacy and the environmental requirements.

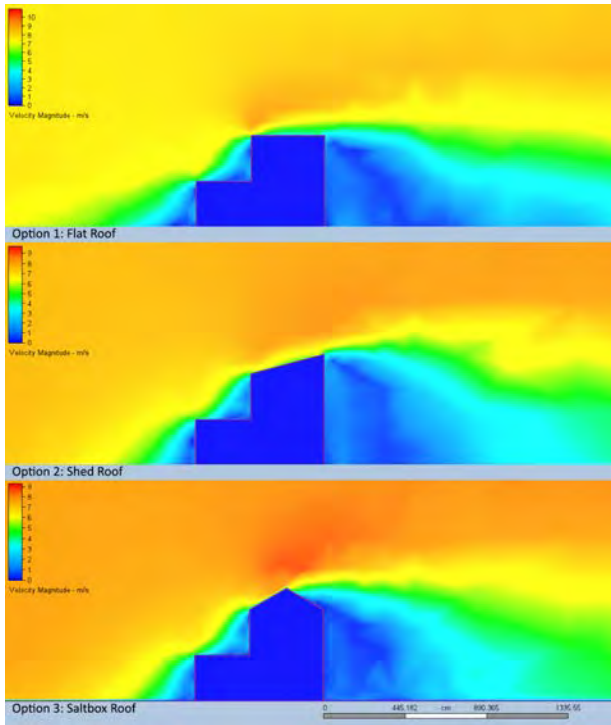




**Figure 2:** Wind direction vectors and velocity distributions of the site design options, simulated in ENVI-met. Source: (Author 2021)

### 2.3. Massing

The various building form options were also tested with airflow simulations using Autodesk Simulation CFD (ASCFD) to investigate the influences of the shape on the airflow around the buildings. The Massing stage of the framework was followed to set up the simulation strategies. The air velocity distributions around the building in each of the roof shape options were simulated in ASCFD, as shown in Figure 3. The flat roof option had the widest area with low velocity, which means less natural airflow around the building. The air velocity on the roof was higher than the ground level, specifically the edge of the windward side. The shed roof option had more area with higher air velocity than the flat roof. The air velocity distribution on the roof in this option was the most consistent, around 6.5 m/s. The saltbox roof option had the least area with low velocity on the ground level. The air velocity distribution on the leeward-side roof varied from 0 to 7 m/s, but the windward-side roof had a consistent distribution around 7 m/s. The air pressure distributions around the building in the roof design options were simulated in ASCFD as well. It was assumed that the wind was coming from the left side of the images. The flat roof and the shed roof had a negative pressure on the windward side of the roof, and the saltbox roof had a negative pressure on the leeward side of the roof. Since the negative pressure on the saltbox roof is higher than other options, this option may have more risks of wind uplift. In summary, the saltbox roof option had the highest risk of wind uplift due to the negative air pressure on the roof, although the building shape may induce more natural airflow on the ground-level. The flat roof option had less negative air pressure on the roof compared to the saltbox option but reduced the high-velocity area on the ground-level. The shed roof option had the lowest risk of wind uplift and more natural airflow on the ground-level than the flat roof. Therefore, this option is recommended if a strong wind is an issue, while the saltbox roof is recommended if maximizing natural airflow is more important than the wind uplift issues. Since Baton Rouge has a hurricane season, the shed roof or the flat roof designs would be recommended.



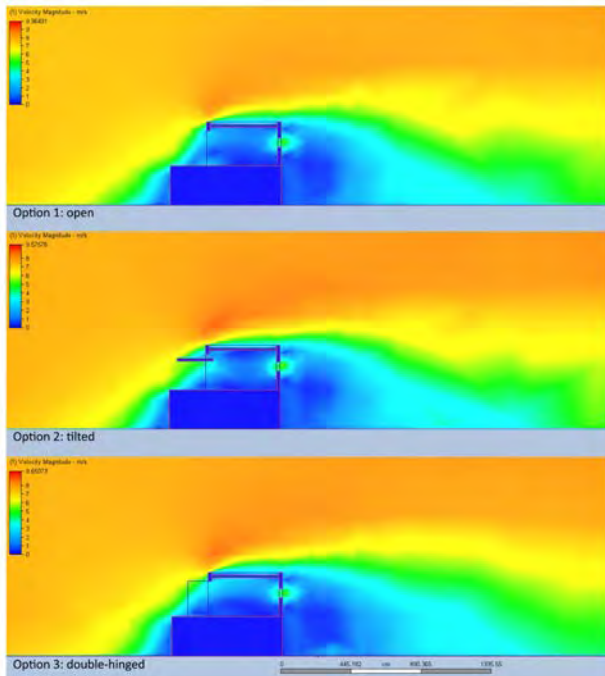
**Figure 3:** Air velocity distributions of the roof design options, simulated in ASCFD. Source: (Author 2021)

#### 2.4. Interior space planning

The ground-level plan of the building was also tested with an airflow simulation using the multi-zone method, which can be an alternative to CFD in the early stages of space planning, specifically for large-scale buildings with complex interior plans. Although the multi-zone method cannot generate the detailed distribution of air pressure or velocity as CFD does, it simulates the amount and the direction of airflow from a zone to another zone in a timely manner. For example, Tan and Glicksman (2005) reported that a CFD simulation of a large-scale building might take over ten hours, whereas the multi-zone method might reduce the simulation time to less than one hour. For transient simulations studying a longer period, such as a whole season, the difference in the simulation time would be more significant. In this study, CONTAM was employed to use the multi-zone method. The data from Climate Consultant were used to set the weather condition in CONTAM. Based on the wind data from Climate Consultant, the southeast was considered the prevailing wind direction of the site. The velocity of the wind from the data was 4.5 m/s. Since the wind data were measured at the height of 23 m from the ground, the wind velocity at the center of ground-level (1.5 m) was recalculated using the logarithmic law. The roughness length of the project site was considered 0.4 m. The recalculated southeast wind velocity was 2.5 m/s. For completing the boundary setting of the CONTAM simulations, the properties of windows and doors were additionally identified. Each residential unit has one large double-casement window, one small casement window, and a large operable door open to the community space or the outdoor terrace. Each community space, which includes a shared kitchen and a shared living room, has two two-lite-slider windows and a single glass door. The inlet wind pressure was 3.75 Pa when the air density was assumed 1.2 kg/m<sup>3</sup>. Similar to the site planning studies, the simulated weather condition was August 15<sup>th</sup> around 3 PM. Referring to the temperature data from Climate Consultant, the outdoor temperature was assumed 20 °C, and the indoor temperature was assumed 25 °C. The multi-zone simulations demonstrate the direction of airflow from outside to individual units, community space, and back to outside, along with the amount of moving air. For example, the CONTAM simulation indicates that the mass flow rate of the airflow from the unit to the community space is 2.80 kg/s, and the air pressure is about 0.59 Pa. Based on these data, the airflow velocity is about 0.99 m/s, and the direction is from the unit to the community space. Multi-zone simulations can be specifically useful for creating simple airflow diagrams in the early stages of design.

#### 2.5. Façade design

The various façade design options were tested with airflow simulations using Autodesk Simulation CFD (ASCFD) and COMFEN to investigate the influences of the opening types on the airflow in and around the buildings. This project had different façade design options. Among the options, fully open, tilted, and double-hinged openings were selected for this project. The air velocity in and around the buildings in the selected options was simulated in ASCFD. Figure 4 shows the sectional views from the simulations at the center of the building with an assumption that the wind was coming from the left side.



**Figure 4:** Sectional views of the three design options and air velocity distribution. Source: (Author 2021)

The air velocity on the upper-floor terrace increased in Option 2 (tilted), specifically under the tilted door. The interior airflow moved to a lower level, closer to the breathing zone, compared to Option 1 (open). The upper-floor terrace area in Option 3 (double-hinged) had a similar airflow pattern to Option 1, while the interior airflow in Option 3 had a higher air velocity. In the plan view, both the interior and exterior air velocity increased in Option 2, specifically around the opening area. In Option 3, the air velocity decreased as the hinged doors protected the space from incoming airflow. Since maximizing natural ventilation was the design goal, Option 2 would be the recommended design option for this project. Additional façade simulations using COMFEN were also conducted to study the impacts of different window types on natural ventilation. COMFEN is a building performance simulation tool developed by the Lawrence Berkeley National Laboratory (LBNL), particularly focusing on the energy and lighting analyzes of façade systems. The natural ventilation simulation is a new function of this software, which generates the indoor temperature with natural ventilation. Although this function does not show detailed airflow information like CFD or the multi-zone method, it may be useful for testing the natural ventilation performance of façade design options coupled with energy and lighting simulations. The quick simulation time is also a benefit of using COMFEN. Different from CFD, COMFEN easily generates yearly simulation data. In this case study project, COMFEN was employed to simulate the natural ventilation performances of different opening types for this window, including casement, awning, and single-hung. The COMFEN simulation results indicated that the operable windows may reduce the indoor temperature by 20 % compared to the fixed window on a hot summer day. Among the three window options, the natural ventilation with a casement window was the most effective in reducing the indoor temperature, although the difference with an awning window was minimal. The indoor temperature of the single-hung option was slightly higher than the other two window options.

### 3.0. CONCLUSION

This paper investigated how computational fluid dynamics (CFD) and other alternative simulation platforms can be utilized in various architectural design phases and compared the simulation configurations in different design stages. Based on the reviewed literature, a recommended set of simulation parameters can be established that may serve as a recipe for CFD simulations in the early stages of architectural design. Based on the established framework, an immersive case study was conducted to test the application of the proposed procedural model. A modular housing project in Baton Rouge, Louisiana, was selected for the immersive case study in which the author played the project designer's role. In each design stage of the project, the decision-making process interacted with different types of airflow simulations. Architectural designers may utilize this procedural model as a framework for the application of CFD and other alternative airflow simulations in the early stages of architectural design.

## REFERENCES

- Abohela, Islam, Neveen Hamza, and Steven Dudek. 2013. 'Effect of roof shape, wind direction, building height and urban configuration on the energy yield and positioning of roof mounted wind turbines', *Renewable Energy*, 50: 1106-18.
- Blocken, Bert, and Jan Carmeliet. 2008. 'Pedestrian wind conditions at outdoor platforms in a high-rise apartment building: generic sub-configuration validation, wind comfort assessment and uncertainty issues', *Wind and structures*, 11: 51-70.
- Blocken, Bert, WD Janssen, and Twan van Hooff. 2012. 'CFD simulation for pedestrian wind comfort and wind safety in urban areas: General decision framework and case study for the Eindhoven University campus', *Environmental Modelling & Software*, 30: 15-34.
- Blocken, Bert, and J Persoon. 2009. 'Pedestrian wind comfort around a large football stadium in an urban environment: CFD simulation, validation and application of the new Dutch wind nuisance standard', *Journal of Wind Engineering and Industrial Aerodynamics*, 97: 255-70.
- Chen, Qingyan, Kisup Lee, Sagnik Mazumdar, Stephane Poussou, Liangzhu Wang, Miao Wang, and Zhao Zhang. 2010. 'Ventilation performance prediction for buildings: model assessment', *Building and Environment*, 45: 295-303.
- Franke, J, A Hellsten, H Schlünzen, B Carissimo, and COST Action. 2007. '732: Best practice guideline for the CFD simulation of flows in the urban environment', *University of Hamburg, Meteorological Institute, Hamburg, Germany*.
- Hitchcock, Robert J, Robin Mitchell, Mehry Yazdani, Eleanor Lee, and Charlie Huizenga. 2008. 'COMFEN: A commercial fenestration/façade design tool', *Proceedings of SimBuild*, 3: 246-52.
- Jo, Soo Jeong, James Jones, and Elizabeth Grant. 2018. "Trends in the application of CFD for architectural design." In *ARCC (Architectural Research Centers Consortium)*. Philadelphia.
- Kim, Jihun, Yun Kyu Yi, and Ali M Malkawi. 2011. "Building form optimization in early design stage to reduce adverse wind condition-using computational fluid dynamics." In *12th Conference of International Building Performance Simulation Association, at Sydney, Australia*.
- Kosutova, Katarina, Twan van Hooff, Christina Vanderwel, Bert Blocken, and Jan Hensen. 2019. 'Cross-ventilation in a generic isolated building equipped with louvers: Wind-tunnel experiments and CFD simulations', *Building and Environment*, 154: 263-80.
- Milne, Murray, Robin Liggett, Andrew Benson, and Yasmin Bhattacharya. 2009. "Climate Consultant 4.0 develops design guidelines for each unique climate." In *American Solar Energy Society Meeting*.
- Ray, Stephen D, Nan-Wei Gong, Leon R Glicksman, and Joseph A Paradiso. 2014. 'Experimental characterization of full-scale naturally ventilated atrium and validation of CFD simulations', *Energy and Buildings*, 69: 285-91.
- Roy, K, and A Kumar Bairagi. 2016. 'Wind pressure and velocity around stepped unsymmetrical plan shape tall building using CFD simulation—A case study', *Asian J. Civil Eng.(BHRC)*, 17: 1055-75.
- Salata, Ferdinando, Iacopo Golasi, Roberto de Lieto Vollaro, and Andrea de Lieto Vollaro. 2016. 'Urban microclimate and outdoor thermal comfort. A proper procedure to fit ENVI-met simulation outputs to experimental data', *Sustainable cities and society*, 26: 318-43.
- Tan, Gang, and Leon R Glicksman. 2005. 'Application of integrating multi-zone model with CFD simulation to natural ventilation prediction', *Energy and Buildings*, 37: 1049-57.
- Tominaga, Yoshihide, Akashi Mochida, Ryuichiro Yoshie, Hiroto Kataoka, Tsuyoshi Nozu, Masaru Yoshikawa, and Taichi Shirasawa. 2008. 'AIJ guidelines for practical applications of CFD to pedestrian wind environment around buildings', *Journal of Wind Engineering and Industrial Aerodynamics*, 96: 1749-61.
- Toparlar, Yasin, Bert Blocken, Bino Maiheu, and GJF Van Heijst. 2017. 'A review on the CFD analysis of urban microclimate', *Renewable and Sustainable Energy Reviews*, 80: 1613-40.
- van Hooff, Twan, Bert Blocken, and Yoshihide Tominaga. 2017. 'On the accuracy of CFD simulations of cross-ventilation flows for a generic isolated building: comparison of RANS, LES and experiments', *Building and Environment*, 114: 148-65.
- Wu, Hanqing, and Frank Kriksic. 2012. 'Designing for pedestrian comfort in response to local climate', *Journal of Wind Engineering and Industrial Aerodynamics*, 104: 397-407.
- Wu, Yu-Chou, An-Shik Yang, Li-Yu Tseng, and Chin-Lung Liu. 2011. 'Myth of ecological architecture designs: Comparison between design concept and computational analysis results of natural-ventilation for Tjibaou Cultural Center in New Caledonia', *Energy and Buildings*, 43: 2788-97.
- Yuan, Chao, Ruiqin Shan, Ayu Sukma Adelia, Abel Tablada, Siu Kit Lau, and Stephen Siu-Yu Lau. 2019. 'Effects of vertical farming on natural ventilation of residential buildings', *Energy and Buildings*, 185: 316-25.



# Integrating CFD with ANN to Maximize Electricity Generation from the Wind Turbine Pavilion

Yun Kyu Yi<sup>1</sup>, Keunhyuk Jang<sup>1</sup>, Andrew Chun-An Wei<sup>1</sup>, Bhujon Kang<sup>1</sup>, Manal Anis<sup>1</sup>

<sup>1</sup>University of Illinois, Urbana-Champaign, IL

**ABSTRACT:** This paper is to develop a design strategy to find an aerodynamic form for a pavilion that can be used to optimized to generate on-site electricity from wind turbines that is hidden inside the pavilion. Unlike the open field, where no obstructions are nearby, the most significant limitation of wind turbine applications in urban areas can be found in its complexity of the surrounding site conditions. It is challenging to design a wind turbine near an urban area. For that reason, the paper demonstrates a design method that integrates different computational tools such as machine learning algorithms and computational fluid dynamics (CFD) to predict the accurate CFD result with less computational workload that can maximize the CFD analysis cases with less efforts. The ANN model prediction shows wind energy potential to overcome the particular limitation of installing wind turbines in urban areas. The result also shows the accuracy of ANN prediction without actual CFD simulation.

**KEYWORDS:** Parametric design, Computational Fluid Dynamics (CFD), Artificial Neural Network (ANN), Microclimate Analysis, Wind energy.

## INTRODUCTION

There are several studies regarding wind energy analysis or wind turbine applications to produce electricity. Traditionally, onshore and offshore wind farms have been considered to implement large-scale wind turbines, which cause an extremely expensive cost for constructing, maintaining, and transmitting (Musial and Ram 2010; Louie 2011; Vire 2012; Hemida, Šarkić, and Höffer 2017). In addition, there have been other concerns regarding wind farms such as the negative visual impacts that wind turbines bring to the scenery of offshore or rural areas (Musial and Ram 2010).

Regarding the community risks, residents near wind turbines voice concerns about real estate prices and operation noise as a result of their presence (Musial et al. 2010; Kageyama 2016). Furthermore, for onshore wind farms, the issues are related to land use, the effect on wildlife, and public resistance have caused some countries to ban onshore wind farms (Hemida, Šarkić and Höffer 2017).

For these reasons, this paper suggests that the urban area has the potentials to reduce the negative impacts of onshore and offshore wind farms. The urban area has various merits to capturing clean wind energy because of the short energy delivery distance compared to the conventional energy supply system and the ease of capturing high-speed wind from buildings. In the same vein, recent studies show that urban areas possess a favorable prospect for wind power generation (Tasneem et al. 2020; Idriss et al. 2020) (Stathopoulos et al. 2018). It is not only suggesting urban area as a site, but a small-scale wind turbine is also considered and demonstrated in the urban area from various research studies. If more energy need is present, the study suggests a hybrid system using a small-scale wind turbine and solar cells. (Bilir et al. 2015; Drew et al. 2013). Those merits spark architectural interest, for instance combining wind turbines and daily life structure such as a covered parking space. The suggested design can also function as collective bike parking, bus stops, or other public pavilions.

This paper considers the relatively small scale of wind turbines, including the aerodynamic shape structure to embrace more wind in an urban area with the ease of application and less arbitrary to surrounding scenery. Due to the small size and hidden wind turbine inside the pavilion, it is expected to minimize the noise and prevent collision with birds. However, as there are turbulence problems and unpredictable wind directions around urban areas, careful wind analysis is critical to installing small wind turbines in the urban area. For that reason, an enormous amount of CFD simulation work is expected to forecast around the wind turbine area. To reduce the CFD workload, this study suggests the machine learning algorithm method. Among the several machine learning algorithms, Artificial Neural Network (ANN) modeling is utilized to substitute the CFD simulations.

Inevitably, the basic CFD simulations need to be performed to generate the sample data to support the ANN model procedure. The NURB system is also used to create the different shapes of the structure which is connected to the CFD simulation process. The ANN models predict the reliable CFD results to determine the pavilion's shape, and orientation with less time and computing, which is crucial for solving complex and large-scale problems. Overall, this

study's primary goal was to find satisfactory ANN models to predict the accurate CFD result with less CFD simulation. The suggested method is integrating CFD with ANN to achieve rapid simulation with high accuracy. More detail about how ANN is integrated with CFD can be found below.

## 1.0 METHODOLOGY

The first step is modeling the pavilion's geometry. This paper adapts Antonio Gaudi's chain model as one of the appropriate approaches to create an aerodynamic shape pavilion by utilizing natural gravity for structural efficiency. The various geometries are generated by using the gravity integrated with a curvature shape, which possibly increases the wind velocity inside the structure to outflow. Based on this model, the NURBS (Non-Uniform Rational Basis Spline) system is introduced to generate the virtual geometry of the pavilion. The NURBS model can morph the surface to react to the variables' real-time changes as a curvature shape, thus maintaining the given tensional force, which is also controllable. The curvature shape possibly increases the wind velocity inside of the structure to increase the outflow speed. All the detailed geometry control variables are discussed in the parametric geometry (PG) model section.

From step one to obtain PG model, where the pavilion geometry is ready for the CFD model, the second step is developing an ANN model that predicts the outflow speeds of various pavilion shapes. Because running CFD simulations for a whole year takes a significant amount of computational time and power, it is necessary to develop a model that can reduce the number of CFD simulations. To train the ANN model for predicting the pavilion's outflow performance, sample input and output data are collected from the CFD simulations. Once the ANN model is prepared, it is used to predict the geometry control variables that change the shape of the pavilion and its wind performance based on evaluating the various shapes to increase the overall whole year wind speed around an outlet.

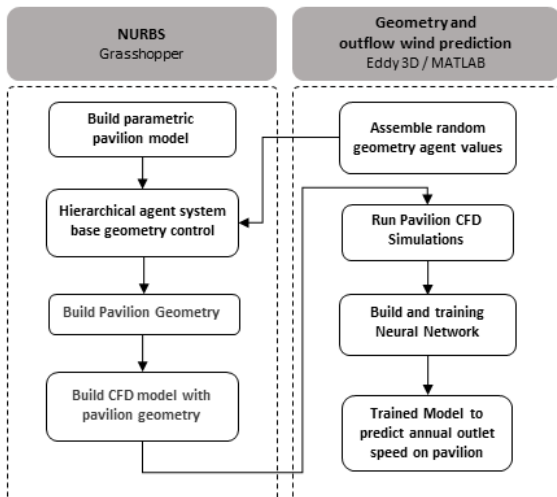


Figure 1: Overall flow of methodology.

## 2.0 THE PARAMETRIC GEOMETRY (PG) MODEL

The Parametric Geometry (PG) model was used to create the potential pavilion shape based on several geometry variables. Parametric geometry modeling is a computerized modeling process through the computer programming code to define the model's dimension and form. Computer coding automation allows designers to reshape the model as soon as the dimensional parameters are modified without redrawing the model (Fu, 2018). Additionally, when the PG has connected the Agent-based Geometry Control System (AGCS), it can efficiently control multiple geometry variables. AGCS helps to define the hierarchical relationships between the agent points and the variables. Thus, integrating the PG model with AGCS can efficiently generate pavilion shape alternatives using a few variables, which ultimately leads to an efficient and successful optimization process.

For the geometry of the pavilion, inspired by Gaudi's structural chain model for the Sagrada Familia, the doubly curved geometry intends to demonstrate how a geometrical complexity can accommodate pragmatic demands and engineered operations. In this sense, the conceptual idea begins to satisfy two conditions: 1) the covered parking space, and 2) the seamless wind tunnel. Maintaining the minimum volume 2.5 m (W)x 6 m (L)x 2.1 m (H) inside the pavilion as a covered parking space, the morphed surface utilizes the front entrance as the parabolic inlet while the outlet is dynamically changed by the variables.



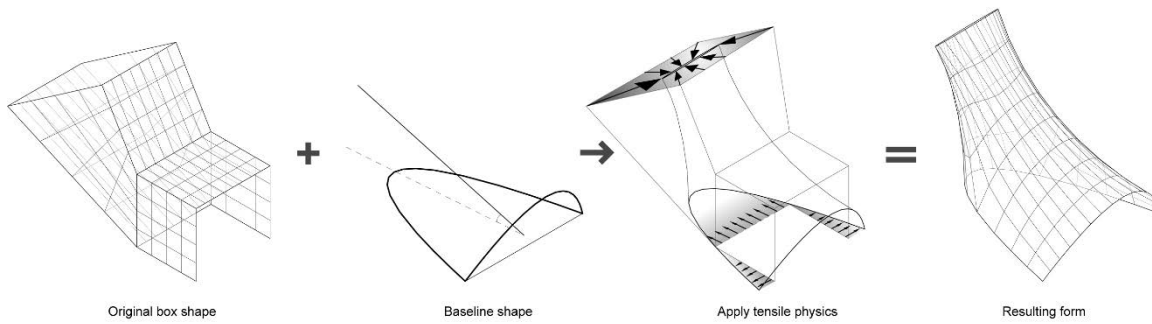


Figure 2: The principle of geometry morphing.

Regarding the geometry control variables, the four agent variables are utilized for the morphing process, as shown in Figure 3. The following four agent variables are set to reduce the complexity of the controlling geometry: 1) an inlet tilt angle for the parabolic entrance, 2) the outlet elongation angle related to the pavilion height, 3) the outlet diameter dimension, and 4) the pavilion orientation angle that determines the pavilion facing the orientation to the wind. The range of the tilt angle at the entrance is between  $-25^\circ$  and  $+25^\circ$ ; for pavilion height, it is between  $10^\circ$  to  $50^\circ$ ; for outlet diameter, it can be between 1.219m to 3.657m; and for rotation, the pavilion can rotate 360 degrees.

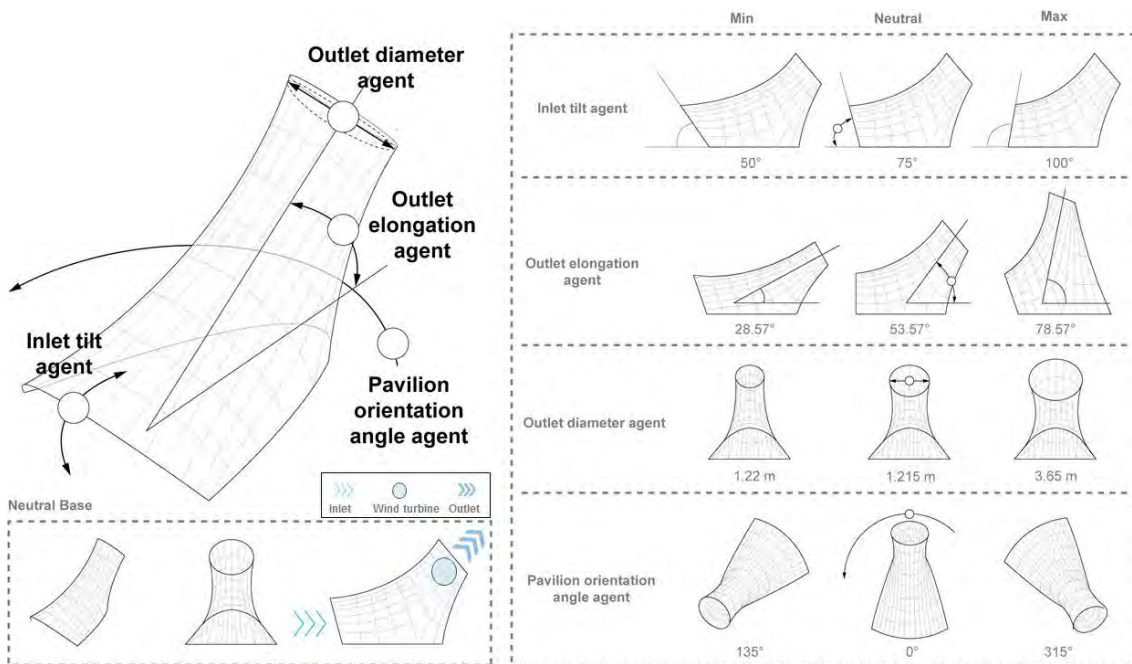


Figure 3: The pavilion geometry's agent variables.

### 3.0 PAVILION OUTLET WIND SPEED PREDICTION

For the wind speed prediction of the pavilion outlet, this study used ANN models to find the relation between the geometry variables and the pavilion outflow wind speed. This process requires generating the ANN training data set from the selected CFD simulations. Moreover, with the collected sample data, the ANN model predicts the pavilion's outlet wind speed.

As shown in Figure 4, the pavilion and outflow wind prediction models are composed of two steps to assemble the ANN training data set and the ANN model training. Four geometry control variables' minimum and maximum value combinations (16 cases) are used to generate the input training data sets, adding to the 16 cases. Another 56 cases are randomly generated between the minimum and maximum range of variables. The overall total of 72 cases is prepared for the input data set for the training. These 72 data sets are simulated with the CFD to find two output variables for the training.

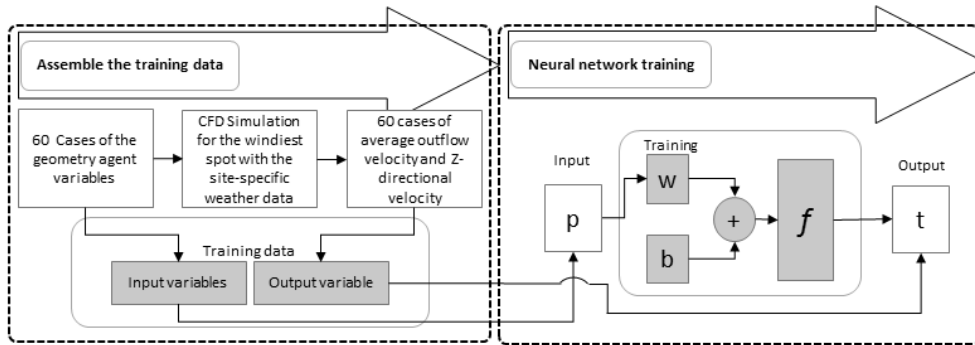


Figure 4: Geometry and outflow wind prediction flow chart.

The CFD simulation to find the outlet wind conditions used Eddy3d (Dogan and Kastner 2021) to find the wind speed and wind direction. Another benefit of using Eddy3d is it is built inside of the NURBS CAD tool that does not require CAD geometry to export to an independent CFD simulation tool. As the four variables change the shape of the pavilion, its revised geometry can be simulated to find the outflow wind speed within the CAD tool using Eddy3d accordingly.

Regarding the CFD setup, the  $k-\epsilon$  Renormalization Group (RNG) model is used for the turbulence modeling, and the SIMPLE algorithm is used for pressure and velocity coupling. The Eddy3d automatically calculates the initial wind speed for different heights. The same cylindrical domain is used for the test (Kastner and Dogan 2020), and the mesh is created by OpenFOAM's (OpenFOAM 2011) blockMesh and snappyHexMesh.

The pavilion CFD model's domain does not account for the site surroundings from this study to generate the high resolution ANN model. The simulation domain is set up with a radius of 91 m, and the height of the domain is set as 34 m, which results in 485,526 mesh cells. A side view of the cylindrical mesh with the pavilion cutout and the one case pavilion CFD simulation result is shown in Figure 5.

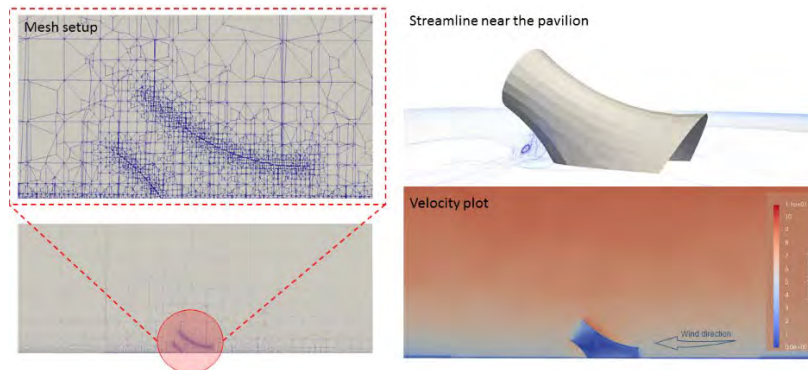


Figure 5: Mesh and CFD simulation result.

Two output variables are calculated from the CFD simulation: the first variable is the average annual hourly wind speed at the proposed location where the wind turbine will be located in the pavilion, and the second variable is the average annual hourly z-direction velocity magnitude. The Eddy3d has a function that can calculate hourly wind speed based on dimensionless wind velocity with the corresponding velocity and wind direction from the weather data for every hour of the year. This can generate a matrix with wind reduction factors, and based on this matrix, the specific measuring points' hourly wind speed can be calculated. The study used this function to calculate the average wind speed of the pavilion outlet area. It can calculate different shapes of the pavilion's outlet wind speed for the whole year. Another measure that we calculated is the annual hourly z-direction velocity magnitude. It is to measure whether or not the winds were heading upward to increase the wind turbine rotation. If the average z-direction velocity magnitude is negative, winds are coming from the opposite direction (from the outside outlet to the inside outlet), which will reduce the rotation of the turbine.

Once the CFD model is set to simulate the different shapes of the pavilion, the ANN model is set up to reduce the number of CFD simulations. Table 1 summarizes the setup for the outflow ANN model training. This paper creates two separate ANN models for outflow wind speed and z-direction velocity magnitude. Both ANN models use the same 72 input sample data set for the training. The number of neurons is defined as 20 for both models. Levenberg-Marquardt backpropagation network training function is used to update weight and bias values. The tangent sigmoid

(TANSIG) transfer function is used to calculate a layer's output from its net input, and the gradient descent with momentum weight and bias learning function (learngdm) is used for calculating the weight change of a neuron. Data are randomly divided for training (70%), validation (15%), and testing (15%), and Mean Squared Error (MSE) is used to check its performance.

Table 1: Set up for pavilion outlet area wind condition ANN models.

ANN		Dataset size	Number of Neurons	No. of Layers	Training Function	Transfer Function
Separated	Average annual hourly wind speed	72	20	2	Levenberg-Marquardt backpropagation algorithm	Tangent sigmoid (TANSIG)
	Annual hourly z-direction velocity magnitude		20		Levenberg-Marquardt backpropagation algorithm	Tangent sigmoid (TANSIG)
Adaptation learning function			Gradient descent with momentum weight and bias learning function (learngdm)			
Data Division			Random			
Performance measure			Mean Square Error			

Table 2 and Figure 6 show the two ANNs models' regression analysis. Once each model is trained and tested to compare the trained model's prediction with fully simulation results, both ANN models show the average accuracy of R-value at 0.89, 0.93, respectively. Overall, the regression value indicates that a trained model is reasonable to use for predicting the pavilion outflow wind speed and direction.

Figure 2 shows the principle of variables that can change the geometry. The morphed surface reacts to the geometry baseline from the primitive box shape. Giving the given tensional force to the original shape upon the baselines, the number of subdivisions in each surface determines the level of fragmentation of the morphed model. To convert the segmented straight lines into continuous curves, the Non-Uniform Rational Basis Spline (NURBS) Computational Aided Design (CAD) tool is used to arrange the lines' vertexes to create a series of interpolated curves composed of the patch of network surfaces. Points on the curved surfaces created by the UV coordination were utilized to position the normal vectors of panelized flat surfaces.

ANN Model	Regression value	
Average annual hourly wind speed	Training	0.93
	Validation	0.87
	Test	0.73
	All	0.89
Annual hourly z-direction velocity magnitude	Training	0.93
	Validation	0.97
	Test	0.92
	All	0.93

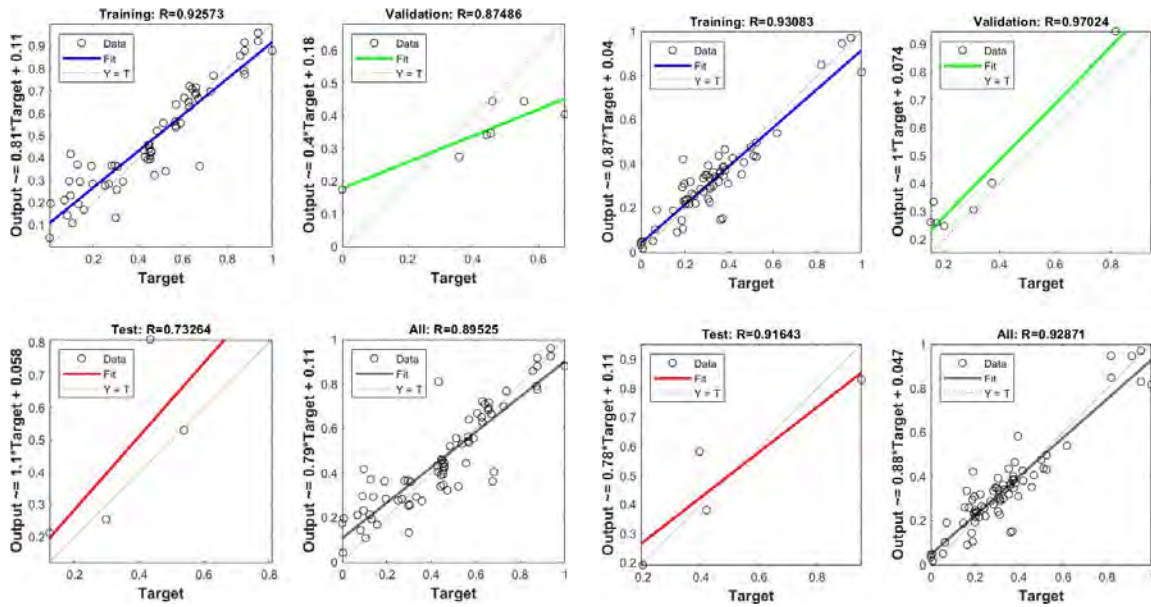


Figure 6: Wind speed regression analysis plot (Left: Average annual hourly, Right: Annual hourly z-direction).

Table 3 shows the sample comparison between ANN prediction and the CFD simulation result with the same configuration. The difference between ANN and CFD for average annual hourly wind speed is 0.137 and for annual hourly z-direction velocity magnitude is 0.155. Similar to regression analysis, wind speed prediction was a little more closer to the CFD measure; however, the sample size is limited, that requires further study to be generalized the outcome.

Table 3: Comparison between ANN and CFD results.

Average annual hourly wind speed (normalized value)	ANN	CFD	Difference
CASE 1	0.328	0.440	0.112
CASE 2	0.194	0.491	0.297
CASE 3	0.657	0.620	0.037
CASE 4	0.622	0.798	0.176
Average	0.450	0.587	0.137
Annual hourly z-direction velocity magnitude (normalized value)	ANN	CFD	Difference
CASE 1	0.407	0.658	0.250
CASE 2	0.187	0.432	0.244
CASE 3	0.388	0.624	0.236
CASE 4	0.302	0.192	0.110
Average	0.321	0.476	0.155

Figure 7 shows the CFD results of 8 different orientation wind of CASE 1. The result shows an increase of speed around inside of pavilion when pavilion inlet opening is facing wind direction, for this case, inlet is facing 45 degrees, an increase of wind can be found when the wind is coming from 0,45, and 90 degrees.



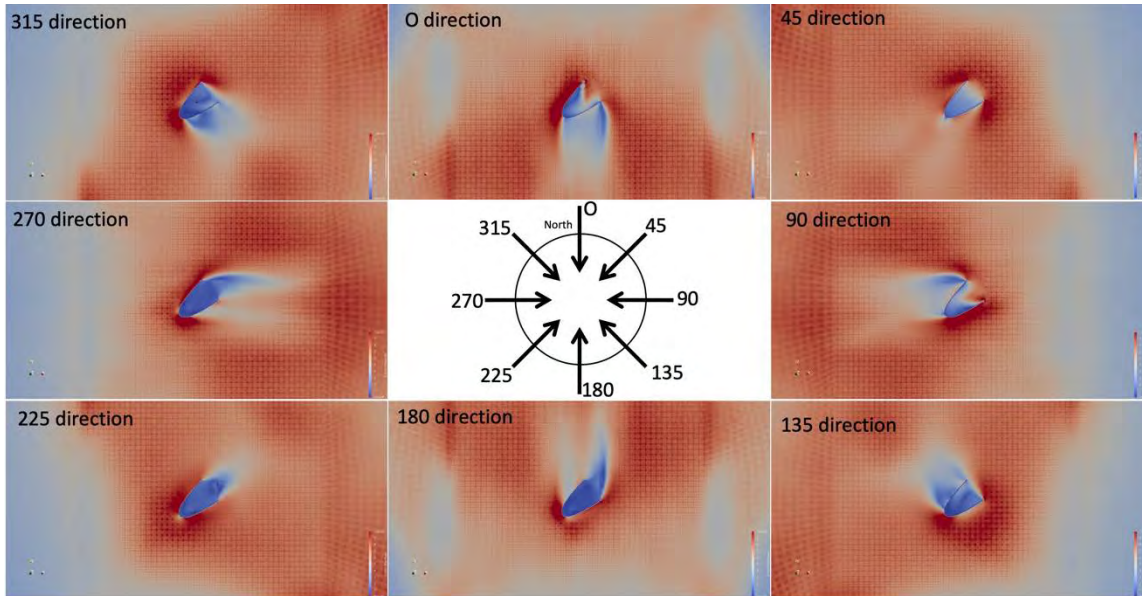


Figure 7: Case one CFD simulation result (Top view).

#### 4.0 DISCUSSION

This study started by researching how to apply the early architectural design process to overcome the negative effects of current wind power generation and supply more efficient electricity to urban areas. For the solutions to those concerns, this paper has provided methods of generating the site-specific wind data and the optimal pavilion form by using CFD and ANN methods. The outcome shows the potential method to improve the pavilion's wind performance prediction that maximizes the surrounding wind condition.

For the geometry shape, four geometry control variables are used to change the pavilion's shape for optimization. To gain a more flexible control geometry and reduce the variables for the optimization, a parametric model was developed using the Agent-based Geometry Control System (AGCS). Once the AGCS geometry is modeled, it is connected with CFD simulation tools to find the wind conditions around the pavilion's outlet. Because conducting multiple CFD simulations is needed for the next optimization process, this study used another ANN model to reduce the CFD simulation for finding the outflow wind speed around the pavilion's outlet. The ANN model showed a close relationship between the prediction and the simulation result. The average R-value for the annual hourly wind speed was 0.89 and 0.93 for annual hourly z-direction velocity magnitude.

To find out accurate wind conditions with less computational work, we suggest integrating the ANN model with CFD simulation. The both trained ANN models show a close relationship between the prediction and the simulation result so that a trained ANN model can be further utilized for finding more accurate analysis.

#### CONCLUSION

This study is an investigation of the possible use of wind turbines in urban areas. The proposed analysis method suggests the potential to find the optimal pavilion form using advanced computer simulation tools and machine learning methods. The proposed method can extend our current limitations of CFD research for accurate investigation; however, it would be beneficial for this study to investigate the urban wind analysis, including the surrounding building in an urban area.

Since this paper suggests the successful potential of the ANN model that can reduce the CFD workload, the future study needs to consider the urban context for the intensive wind analysis. As the author plans to add more variables such as urban geometries, more accurate weather data, and human safety, the developed ANN model from this paper which considers very limited scopes, cannot be used in the future study. It requires more dataset for new ANN model training as a Black box. Additionally, the integration of ANN with multi-objective optimization also can be considered to generate the optimal pavilion form for future study.

#### ACKNOWLEDGEMENTS

This work was supported by Institute for Sustainability, Energy, and Environment (iSEE)'s Living Lab Research Seed Funding at the University of Illinois at Urbana-Champaign.

## REFERENCES

- Bilir, L., Imir, M., Devrim, Y., and Albostan, A. 2015. "An investigation on wind energy potential and small scale wind turbine performance at İncek region–Ankara, Turkey." *Energy Conversion and Management*, 103, 910-923. <https://doi.org/10.1016/j.enconman.2015.07.017>.
- Dogan, T., and Kastner, P. 2021. "Getting Started." Eddy3d. Accessed January 7, <https://www.eddy3d.com/documentation.html>.
- Drew, D. R., Barlow, J. F., and Cockerill, T. T. 2013. "Estimating the potential yield of small wind turbines in urban areas: A case study for Greater London, UK." *Journal of Wind Engineering and Industrial Aerodynamics*, 115, 104-111. <https://doi.org/10.1016/j.jweia.2013.01.007>.
- FSD blueCAPE Lda. 2017 "User Guides." blueCFD-Core Project. FSD blueCAPE Lda. Accessed January 7, 2021. <http://bluecfd.github.io/Core/UserGuide/>.
- Fu, F. 2018. *Design and analysis of tall and complex structures*. 3<sup>rd</sup> ed. Oxford, United Kingdom: Butterworth-Heinemann. <https://doi.org/10.1016/C2015-0-06071-3>.
- Hemida, H., Šarkić, A., and Höffer R. 2017. "On the understanding of the above roof flow of a high-rise building for wind energy harvesting." International conference on wind energy harvesting, Coimbra, Portugal, 81-86.
- Idriss, A.I., Ahmed, R.A., Omar, A.I., Said, R.K. and Akinci, T.C. 2020. "Wind energy potential and micro-turbine performance analysis in Djibouti-city, Djibouti." *Engineering Science and Technology, an International Journal*, 23(1), 65-70. <https://doi.org/10.1016/j.jestch.2019.06.004>.
- Kageyama, T., Yano, T., Kuwano, S., Sueoka, S., and Tachibana, H. 2016. "Exposure-response relationship of wind turbine noise with self-reported symptoms of sleep and health problems: A nationwide socioacoustic survey in Japan." *Noise & Health A Bimonthly Inter-disciplinary International Journal*, 18(81), 53–61. <https://doi.org/10.4103/1463-1741.178478>.
- Kastner, P. and Dogan, T. 2020. "A cylindrical meshing methodology for annual urban computational fluid dynamics simulations." *Journal of Building Performance Simulation*, 13(1), 59-68. <https://doi.org/10.1080/19401493.2019.1692906>.
- Louie, H. 2011, July. "Experiences in the construction of open source low technology off-grid wind turbines." Detroit, MI: IEEE Power and Energy Society General Meeting, 1-7. <https://doi.org/10.1109/PES.2011.6038924>.
- Musial, W. and Ram, B. 2010. "Large-scale offshore wind power in the United States: Assessment of opportunities and barriers (No. NREL/TP-500-40745)." Golden, CO (United States): National Renewable Energy Lab.(NREL). <https://www.nrel.gov/docs/fy10osti/40745.pdf>.
- OpenFOAM., 2011. "The OpenFOAM Foundation." OpenFOAM. The OpenFOAM Foundation Ltd, January 1, 2021. <https://openfoam.org/>.
- Stathopoulos, T., Alrawashdeh, H., Al-Quraan, A., Blocken, B., Dilimulati, A., Paraschivou, M. and Pilay, P. 2018. "Urban wind energy: Some views on potential and challenges." *Journal of Wind Engineering and Industrial Aerodynamics*, 179, 146-157. <https://doi.org/10.1016/j.jweia.2018.05.018>.
- Tasneem, Z., Noman Al, A., Das K., S., Saha K., S., Islam, Md. R., Ali Md. F., Badal Md. Faisal R., Ahamed Md. H., Moyeen I. S., and Alam F. 2020. "An analytical review on the evaluation of wind resource and wind turbine for urban application: prospect and challenges." *Developments in the Built Environment* 4, 100033. <https://doi.org/10.1016/j.dibe.2020.100033>.



# Energy Performance of Solar-Reflective Building Envelope on Retail Strip Malls - A Case Study

Roja Rastegar<sup>1</sup>, Jae Chang<sup>1</sup>

<sup>1</sup>University of Kansas, Lawrence, KS

**ABSTRACT:** In the United States as with many other countries, building energy consumption has dramatically increased over the past decade due to population growth, increased demand for indoor environmental quality, and global climate change. One of the goals of architectural design is to provide indoor conditions where individuals can carry out their daily activities in a comfortable energy efficient environment. Space conditioning which is greatly impacted by heat transfer through the building envelope makes up a major portion of a building's energy consumption. One method of minimizing heat transfer and reducing solar heat gain is by optimizing the building envelope thermal performance. This can be accomplished by increasing the R-value through more insulation. However, increasing insulation in existing buildings is more difficult than with new construction. Several studies have shown that surface treatments and application of solar-reflective coatings can reduce the solar absorption rate of a building envelope, which may result in the reduction of cooling load in summer.

This paper presents the findings of a study that examined the effectiveness of improving the thermal performance of existing building envelopes without adding thickness to the walls with additional insulation but instead with a thin exterior solar-reflective coating. EnergyPlus was used to simulate the thermal performance of a case study retail strip mall in four different climate zones in the United States. The simulation was performed for two building envelope conditions in each zone. The first condition was without surface treatment and the second condition was with a solar-reflective coating with a solar reflectance value of 0.6. Results showed potential energy savings between 0-10.5% depending on the climate zone. The hot-humid climate achieved the most energy savings while climate zone with cold winters saw no energy benefits and instead were penalized with increased heating.

**KEYWORDS:** Energy saving, solar reflectance, solar absorption, building envelope

## INTRODUCTION

Building envelope solar radiation control is an effective way to decrease building energy demand. Solar-reflective coatings for walls and roofs can reduce the absorption of solar energy through the building envelope. They can decrease the surface temperature and cooling load of a building. However, they may increase the heating load during the cold season. The overall benefit of these coatings depends on several factors such as: climate condition, building location and orientation, building geometry, window to wall ratio, wall-floor area ratio, building type, construction type, and building age.

One of the major areas that solar-reflective coatings can help is in the energy and thermal retrofit of old existing buildings. Older buildings are usually hampered by poor insulation properties and less efficient HVAC systems compared to newer buildings resulting in higher energy demand. In the last few years advanced building envelope materials and techniques, such as solar-reflective coatings have attracted increasing interest since they can improve the thermal performance of a building envelope without major construction work and without increasing the thickness of the walls or roof.

There are many studies (Levinson et al. 2005; Levinson et al. 2010; Suehrcke et al. 2008; Akbari, et al. 2012; Oleson, et al. 2010; Gao et al. 2014; Romeo, et al. 2013; Garg, et al. 2016; Rosado, et al. 2014; Synnefa, et al. 2012; Urban and Roth. 2010; Xu et al. 2012; Hutchinson. 2018; Santamouris, et al. 2014) which have examined the benefits of solar-reflective "cool roofs" covering topics ranging from building energy demand reduction to reducing the urban heat island effect. However, studies on the application of solar-reflective "cool" materials on exterior walls lag behind those for the roof. Zinzi. 2016, studied the energy savings of cool walls on residential buildings located in three cities, Athens, Cairo and Marseille, through computer simulation. Results showed the potential of the technology in improving energy performance and impact on indoor thermal comfort. The average indoor operative temperature was reduced by up to 1.1°C (2°F) in unconditioned buildings during the summer period. The average exterior surface temperature reductions were up to 7.5°C (13.5°F), with peak reductions up to 25°C (45°F), per 0.1 increase in solar reflectance. Moujaes et al. 2003, studied the thermal performance of a highly reflective paint applied sequentially to the outer walls and roof of a simulated residence in a hot and arid region of the southwestern United States. The model focused on the potential

cooling load reduction due to the reduced heat pickup from the inside attic surfaces to the outer surfaces of the supply duct. The simulation showed that a reduction of 33.6% (cooling load) on average is achieved over the base case where no reflective coating is used when the outer surface of the roof and walls are coated. Alternatively, only an 11% reduction would be achieved if the reflective coating is applied only to the roof.

The 2020 U.S. Energy Information Administration (EIA) report shows that commercial buildings which include offices, malls, stores, schools, hospitals, hotels, warehouses, restaurants, and places of worship and public assembly use 18% of total U.S. energy consumption by end-use sector with space conditioning being one of the largest consumers of energy (U.S. Energy Information Administration (EIA) 2020).

This paper quantifies the effectiveness of applying solar-reflective coating to the building envelope of pre-1980 retail strip malls as a means of improving the buildings' energy efficiency without increasing the thickness of the walls and roof with additional insulation. Retail strip malls were selected for the study because the two largest energy-using sectors in the commercial building stock are offices and retail. Research by the ENERGY STAR program supported by the United States Environmental Protection Agency (US EPA) shows that until year 2008 there were approximately 657,000 retail buildings in the U.S., a number that represents about 13.5% of all U.S. commercial space. These buildings include stand-alone facilities, strip malls, and enclosed malls. Together, they consume approximately \$21 billion worth of energy annually (U.S. Environmental Protection Agency 2008). The U.S. Energy Information Administration's (EIA) Commercial Building Energy Consumption Survey (CBECS) revealed that commercial buildings built before 1960 represent 21% of the building stock and those built between 1960 and 1999 account for 54%. So, about 75% of the commercial buildings in the United States were built before 2000 (U.S. Department of Energy 2020), and therefore are good candidates for energy efficiency retrofits. While there are many studies covering the area of improving the energy efficiency of existing office buildings, there are fewer studies examining it for existing retail buildings and specifically strip malls.

## 1.0 RESEACH DESIGN

For the purpose of this study a typical pre-1980s strip mall was modeled for four climate conditions in the United States. The building geometry follows the commercial building benchmark models recommended by U.S. Department of Energy (DOE) for energy simulation (PNNL 2016). The building construction and schedule for each climate zone follows the ASHRAE Standard 169-2013 for energy simulation of pre-1980 strip malls. For each climate zone there are two configurations: a control configuration without the solar-reflective coating on roof and walls and a modified configuration with solar-reflective coating applied to the roof and walls. The annual heating and cooling energy consumption results of the modified configurations for each climate were compared to those of the control configurations to determine if the solar-reflective coating resulted in energy savings or penalties.

### 1.1 Research Objective

The objective of this research was to examine the energy savings or penalties resulting from applying solar-reflective coating to the exterior of pre-1980 strip malls in four different climate zones as an alternative to adding insulation for energy retrofit.

### 1.2 Building Simulation Locations

Four different climate conditions located in four cities in the United States were selected to test the effects of solar-reflective coating on the building envelope (Table 1).

City	State	United States climate zone (USCZ)	Building America climate zone	Location
Miami	Florida	1A	Hot-Humid	25° 46' 31" N 80° 12' 32" W
Phoenix	Arizona	2B	Hot-Dry	33° 27' N 112° 04' W
Nashville	Tennessee	4A	Mixed-Humid	36° 09' 44" N 86° 46' 28" W
Duluth	Minnesota	7	Very Cold	46° 47' 13" N 92° 05' 53" W

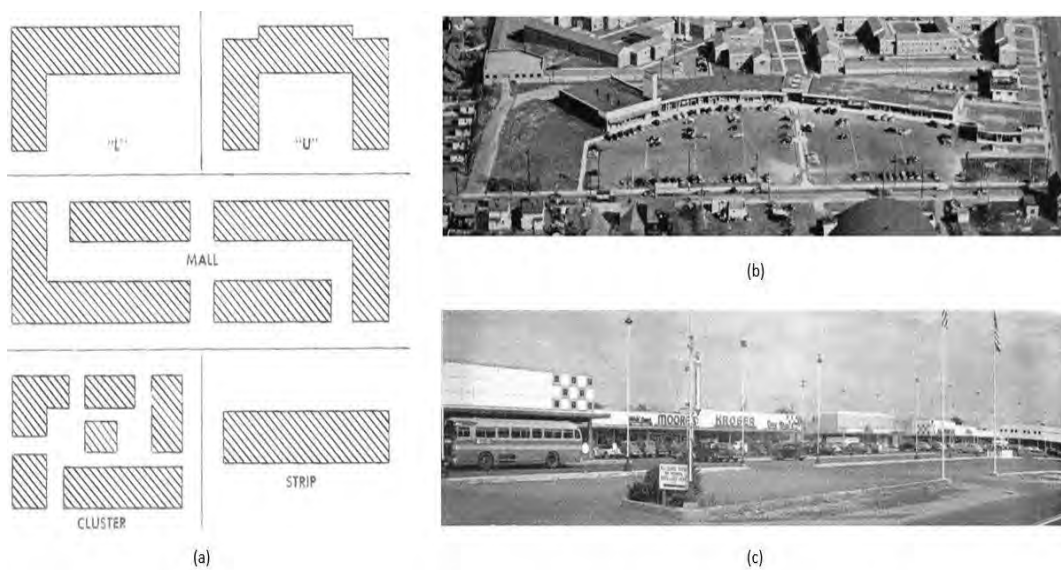
**Table 1:** Cities in the United States used to represent the ASHRAE and Building America climate zones

### 1.3 Building Characteristics and Simulation

Strip malls are a type of service-oriented stores that are found in nearly every city or town in the United States. They were typical shopping centers of the 1950s which provided essential services for nearby residents in suburban neighborhoods (Manning 2009). The Urban Land Institute (ULI) first distinguished the 'strip' in the 1954 edition of the Community Builders' Handbook. The strip was included among four basic shopping center patterns: strip, mall, "U" type, and group or cluster (Urban Land Institute 1954, Manning 2009). By 1968, these typologies had expanded to include the "L" (Fig 1). The "L" and "U" types were considered variations of the strip, a long rectangular form. The strip was defined as:

a straight line of stores tied together by a canopy over the pedestrian walk extending along the entrance fronts to the stores... It is set back from the access street with most of the parking placed between the street and the building. (Urban Land Institute 1968, 320-21)

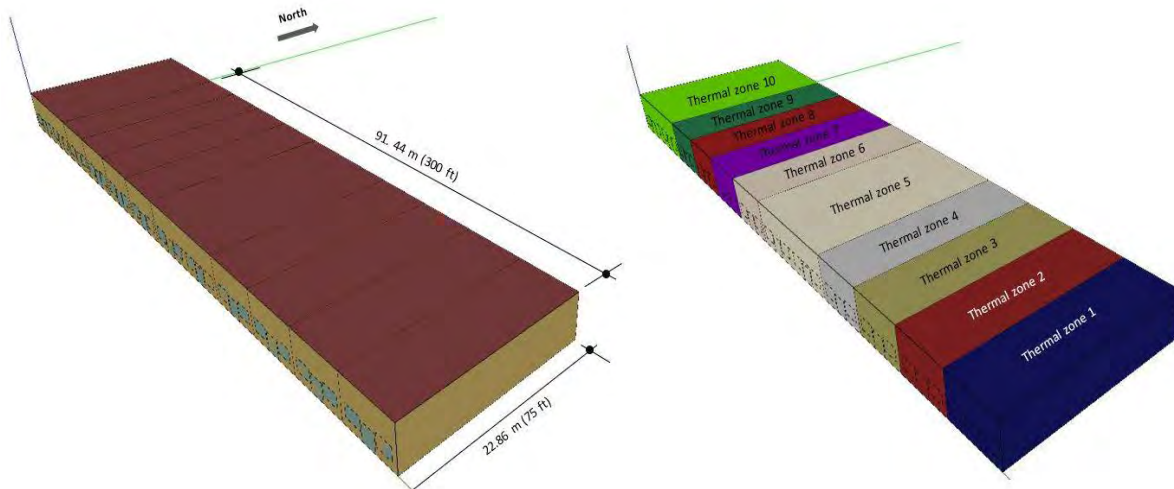
The strip form was considered the cheapest to build and the easiest to adapt to various site conditions (Urban Land Institute 1968, Manning 2009). Strip malls typically range from 464 m<sup>2</sup> (5,000 ft<sup>2</sup>) to 9,290 m<sup>2</sup> (100,000 ft<sup>2</sup>) in floor area.



**Figure 1:** (a) Typical shopping center patterns. (b) Foster Village. Bergenfield, New Jersey. (c) a Don Casto strip shopping center. Source: (Manning 2009)

For this study, the energy simulations of the strip mall retail, test models were conducting using OpenStudio and EnergyPlus. As explained in section 1.0 of this paper, the model test building represents a pre-1980 construction type based on ASHRAE Standard 169-2013 and Department of Energy commercial reference buildings for energy analysis. The stucco finished exterior walls are steel framed with rigid insulation in varying thicknesses to meet climate-zone dependent code requirements of the four different climates used in this study. The roof is a built-up roof with rigid insulation above a metal deck (Table 2).

The strip mall test model has total floor area of 2090 m<sup>2</sup> (22,500 ft<sup>2</sup>) with a floor to ceiling height of 5.2 m (17 ft) (Fig 2). The window to wall ratio is 10.5%, and, all windows are placed in the South. The building is orientated on the east-west axis with the longer facade facing south. The building includes 10 stores. Two stores are larger with the floor area of 348 m<sup>2</sup> (3,750 ft<sup>2</sup>) for each. The other stores each have a floor area of 174 m<sup>2</sup> (1,875 ft<sup>2</sup>).



**Figure 2:** Simulation model of strip mall. (a) Building dimensions. (b) Thermal zones (Each store is considered as one thermal zone)

Each store is considered as a separate thermal zone for the simulation, (Fig 2). Heating, ventilation, and air-conditioning (HVAC) is provided to each store via a single-zone roof top unit (RTU) with constant air volume air distribution, one per store. Thermostat setpoints are set at 24°C (75°F) for cooling and 21°C (70°F) for heating, and, the night setback temperature setpoints are 29°C (85°F) for cooling and 16°C (60°F) for heating. Each store's packaged air-conditioning unit has a coefficient of performance (COP) rating of 3.3. A gas burner with an efficiency of 0.8 inside the packaged air-conditioning unit provides heating. Number of people in each store considered as: 30 people for bigger stores and 15 people for smaller stores.

Location (city, state)	Building Components (exterior to interior)	Overall R-value, h·ft <sup>2</sup> ·°F/Btu	Solar reflectance value (control case)	Solar reflectance value (modified case)
Miami, FL (Case 01)	<u>Wall</u> Stucco 16 mm (5/8 in.) Gypsum board Typical insulation R-2.17 16 mm (5/8 in.) Gypsum board	4.35	0.4	0.6
	<u>Roof</u> Asphalt Typical insulation R-8.88 Metal roof deck	10.0	0.1	0.6
Phoenix, AZ (Case 02)	<u>Wall</u> Stucco 16 mm (5/8 in.) Gypsum board Typical insulation R-2.17 16 mm (5/8 in.) Gypsum board	4.35	0.4	0.6
	<u>Roof</u> Asphalt Typical insulation R-8.88 Metal roof deck	10.0	0.1	0.6
Nashville, TN (Case 03)	<u>Wall</u> Stucco 16 mm (5/8 in.) Gypsum board Typical insulation R-3.44 16 mm (5/8 in.) Gypsum board	5.62	0.4	0.6
	<u>Roof</u> Asphalt Typical insulation R- 10.51 Metal roof deck	11.63	0.1	0.6
Duluth, MN (Case 04)	<u>Wall</u> Stucco 16 mm (5/8 in.) Gypsum board Typical insulation R-5.17 16 mm (5/8 in.) Gypsum board	7.35	0.4	0.6
	<u>Roof</u> Asphalt Typical insulation R- 15.55 Metal roof deck	16.67	0.1	0.6

**Table 2:** Walls and roof construction in each climate zone and solar reflectance values for control and modified cases

### 1.4 Solar Reflectance Value

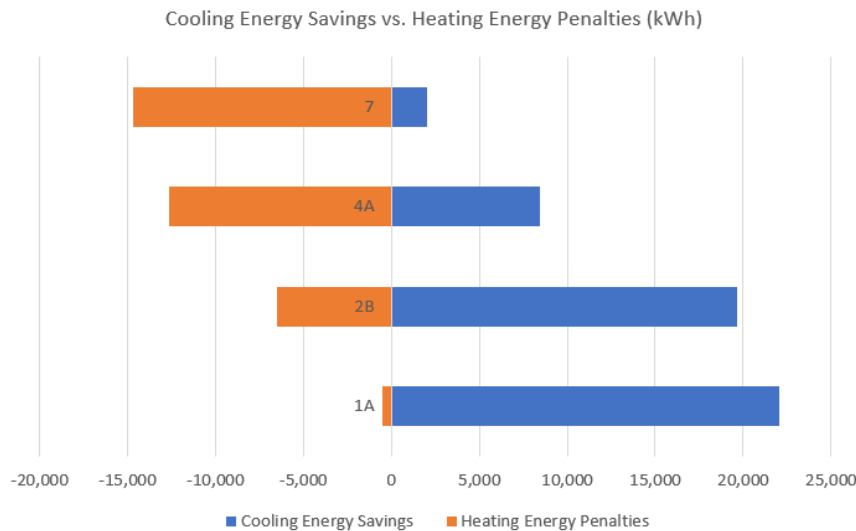
To simulate the impact of solar-reflective coatings on building envelope thermal performance, the control models for all four cases were assigned a solar reflectance value of 0.1 for the asphalt roof and 0.4 for the light to medium colored walls. The modified models for all cases used a solar reflectance value of 0.6 for both the roof and walls. These values were selected based on the research conducted by the Heat Island Group of the Lawrence Berkeley National Laboratory (Rosado, P.J, et al. 2019).

**RESULTS AND CONCLUSION**

This research examined the possibility of applying solar-reflective coatings on walls and roofs as an energy saving retrofit option for existing pre-1980 strip mall buildings in hot-dry (Phoenix, AZ), hot-humid (Miami, FL), mixed-humid (Nashville, TN), and very cold (Duluth, MN) climates. For each location, two cases of the same building but with different solar reflectivity values for the walls and roof were simulated for annual heating and cooling energy consumption. Table 3 and Figure 3 provide summaries of the all cases.

Location	Control Cases		Modified Cases		Heating & Cooling Energy Saving or Penalties	
	Heating kWh (kBtu)	Cooling kWh (kBtu)	Heating kWh (kBtu)	Cooling kWh (kBtu)	Net saving kWh (kBtu)	Net saving percentage
Miami, FL (Case 01)	7,881 (26,890)	197,428 (673,652)	8,364 (28,539)	175,344 (598,300)	21,600 (73,703)	10.5%
Phoenix, AZ (Case 02)	68,711 (234,452)	165,745 (565,544)	75,217 (256,650)	146,067 (498,400)	13,172 (44,946)	6.0%
Nashville, TN (Case 03)	340,586 (1,162,128)	86,331 (294,572)	353,247 (1,205,330)	77,875 (265,721)	-4,208 (-14,357)	-0.9%
Duluth, MN (Case 04)	870,447 (2,970,089)	13,486 (46,017)	885,114 (3,020,134)	11,486 (39,192)	-12,667 (-43,220)	-1.4%

**Table 3:** Annual heating and cooling energy consumption of control and modified cases.



**Figure 3:** Cooling energy savings vs. heating energy penalties (kWh) for the case study climate zones



The simulation results indicated that the application of solar-reflective coatings on the modified cases in hot-humid and hot-dry climates reduced the cooling load compared to the control cases. The net energy savings in the hot-humid climate of Miami, FL was 10.5% and in the hot-dry climate of Phoenix, AZ was 6.0% with solar-reflective coating applied to both the roof and walls of the linear strip mall building. However, in the very cold climate of Duluth, MN the heating penalty was greater than the cooling energy savings resulting in an increase in the overall energy consumption by 1.4%. For the mixed-humid climate of Nashville, TN the overall energy consumption saw a slight penalty with an increase of 0.9%. This shows that in mixed climate depends on the specific location and size and type of the building and construction, the solar-reflective coatings may increase or decrease the overall energy loads by a small amount through the year. The findings of this study indicate that the application of solar-reflective coatings on the walls and roof of existing single-story strip malls is effective in reducing annual energy consumption in hot-dry and hot-humid climates but not effective in cold and mixed-humid climates. For cold and mixed-humid climates, the application of solar-reflective coating with a solar reflectance value of 0.6 results in a slight increase in annual energy consumption due to increased heating load. Future studies should further investigate the application of solar-reflective coatings in more geographic locations.

## REFERENCES

- Akbari, H. Matthews, D., 2012. *Global cooling updates: Reflective roofs and pavements*. Energy and Buildings. Volume 55. Pages 2-6, ISSN 0378-7788, doi.org/10.1016/j.enbuild.2012.02.055.
- ASHRAE 2013. ANSI/ASHRAE Standard 169-2013. *Climatic Data for Building Design Standards*. American Society of Heating, Refrigerating, and Air-Conditioning Engineers, Atlanta, Georgia.
- Gao, Y., Xu, J., Yang, S., Tang, X., Zhou, Q., Ge, J., Xu, T. and Levinson, R. 2014. *Cool roofs in China: policy review, building simulations, and proof-of-concept experiments*. Energy Policy. Volume 74. Pages 190-214. ISSN 0301-4215. doi.org/10.1016/j.enpol.2014.05.036
- Garg, V., Somal, S., Arumugam, R. and Bhatia, A. 2016. *Development for cool roof calculator for India*, Energy and Buildings, Volume 114. Pages 136-142. ISSN 0378-7788. doi.org/10.1016/j.enbuild.2015.06.022.
- Hutchinson, T. 2018. *Cool Roofing Challenging What's Cool*. Eco-structure. Available online at: <http://www.eco-structure.com/cool-roofing/challengingwhats-cool.aspx> (accessed May, 2019).
- Levinson, R. and Akbari, H. 2010. *Potential benefits of cool roofs on commercial buildings: conserving energy, saving money, and reducing emission of greenhouse gases and air pollutants*. Energy Efficiency 3, 53–109. doi: 10.1007/s12053-008-9038-2
- Levinson, R., Berdahl, P., Berhe, A. and Akbari, H. 2005. *Effects of soiling and cleaning on the reflectance and solar heat gain of a light-coloured roofing membrane*. Atmospheric Environment. Volume 39. Issue 40. Pages 7807-7824. ISSN 1352-2310. doi.org/10.1016/j.atmosenv.2005.08.037.
- Manning, M.J. 2009. *The death and life of great American strip malls: Evaluating and preserving a unique cultural resource*. Miami University.
- Moujaes, S. and Brickman, R. 2003. *Thermal performance analysis of highly reflective coating on residences in hot and arid climates*. Energy Engineering-asce. Volume 129. Issue 2.
- Oleson, K.W., Bonan, G.B. and Feddema, J. 2010. *Effects of white roofs on urban temperature in a global climate model*. Geophysical Research Letters. Volume 37. Issue 3. doi:10.1029/2009GL042194
- PNNL, 2016. *Commercial Prototype Building Models*, Pacific Northwest National Laboratory, Richland, WA. Retrieved 2015-10 from [https://www.energycodes.gov/development/commercial/prototype\\_models](https://www.energycodes.gov/development/commercial/prototype_models)
- Romeo, C., Zinzi, M. 2013. *Impact of a cool roof application on the energy and comfort performance in an existing non-residential building. A Sicilian case study*. Energy and Buildings, Volume 67. Pages 647-657, ISSN 0378-7788, doi.org/10.1016/j.enbuild.2011.07.023.
- Rosado, P.J., Faulkner, D., Sullivan, D.P. and Levinson, R. 2014. *Measured temperature reductions and energy savings from a cool tile roof on a central California home*, Energy and Buildings, Volume 80. Pages 57-71, ISSN 0378- 7788, doi.org/10.1016/j.enbuild.2014.04.024.
- Rosado, P.J. and Levinson, R., 2019. *Potential benefits of cool walls on residential and commercial buildings across California and the United States: Conserving energy, saving money, and reducing emission of greenhouse gases and air pollutants*. Energy and Buildings, Volume 199, Pages 588-607, ISSN 0378-7788, <https://doi.org/10.1016/j.enbuild.2019.02.028>.
- Santamouris, M. 2014. *Cooling the cities – A review of reflective and green roof mitigation technologies to fight heat island and improve comfort in urban environments*. Solar Energy. Volume 103. Pages 682-703, ISSN 0038-092X, doi.org/10.1016/j.solener.2012.07.003.
- Suehrcke, H., Peterson, E. L. and Selby, N. 2008. *Effect of roof solar reflectance on the building heat gain in a hot climate*. Energy Build. 40, 2224–2235. doi: 10.1016/j.enbuild.2008.06.015
- Synnefa, A, Saliari, M. and Santamouris, M., 2012. *Experimental and numerical assessment of the impact of increased roof reflectance on a school building in Athens*. Energy and Buildings. Volume 55. Pages 7-15. ISSN 0378-7788, doi.org/10.1016/j.enbuild.2012.01.044.

- Urban, B., and Roth, K. 2010. *Guidelines for Selecting Cool Roofs*. U.S. Department of Energy, Energy, Efficiency and Renewable Energy, Building Technologies, Program.
- Urban Land Institute. Community Builders' Council. 1954. *The Community builders handbook*. Washington. 158.
- Urban Land Institute. Community Builders' Council. 1968. *The Community builders handbook. Anniversary Edition*. Washington. 320-21.
- U.S. Department of Energy (DOE). 2020. *2018 Commercial Buildings Energy Consumption Survey (Preliminary Results)*. U.S. Energy Information Administration Office of Energy Statistics. Washington, DC. available at: <https://www.eia.gov/consumption/commercial>
- U.S. Energy Information Administration (EIA). 2020. *Use of energy explained, Energy use in commercial buildings*, Last updated: September 28, 2018
- U.S. Environmental Protection Agency. 2008. *Energy Star Building Upgrade Manual Facility Type: Retail Chapter 13*. Office of Air and Radiation. 2008 Edition
- Xu, T., Sathaye, J., Akbari, H., Garg, V. and Tetali, S. 2012. *Quantifying the direct benefits of cool roofs in an urban setting: reduced cooling energy use and lowered greenhouse gas emissions*. *Build. Environ.* 48, 1–6. doi: 10.1016/j.buildenv.2011.08.011
- Zinzi, M., 2016. *Exploring the potentialities of cool facades to improve the thermal response of Mediterranean residential*, *Solar Energy*. Volume 135, Pages 386-397. ISSN 0038-092X. doi.org/10.1016/j.solener.2016.06.021.

# A Retrofit Scenario Analysis of Wall Systems and Materials of a Low-Rise Commercial Building

Ash Ragheb<sup>1</sup>

<sup>1</sup>Lawrence Technological University, Southfield, MI

**ABSTRACT:** Buildings are responsible for a significant share of resource and energy use. To quantify the potential for reducing energy and environmental impact, building modelling is commonly used. This focus has expanded to include environmental impacts and life-cycle assessment (LCA). Low impact materials have also become key player towards achieving environmental sustainability in the built environment. Such low impact materials also contribute to cleaner environment, responding to AIA 2030 challenge and many other initiatives by governmental and professional institutions. Building enclosure incorporates many construction materials that contribute to overall embodied energy and environmental impact. It significantly affects building operational energy as a barrier between indoor and outdoor environment. The study method performs a Life Cycle Assessment (LCA) approach to calculate environmental impacts of enclosure systems. The paper models an office building over a service life of 60 years and its implications on the environment from cradle to grave. It also quantifies and compares the total impacts of the assembly systems of this building throughout this life span. The case building is located in the Midwest in zone 5-A, where steel construction is the common method of construction for commercial type in the region. The building is a 3-story high that incorporates few sustainable materials. The study calculates the environmental footprint of the building per unit area (impact to air, water, and land). The study provides an assessment to which building component (structure, walls, floors, roofs) contribute the most to the total building impacts where the worst burden, among its assembly systems, is identified. The outcome tests other materials alternatives to use in the wall system to minimize its impact. The paper employs a retrofit scenario analysis to evaluate replacing high-impact walls materials with alternatives that have less impacts and briefly calculate the reduction in the total impacts against the original construction materials.

**KEYWORDS:** Life Cycle Assessment, Wall Systems, Environmental Impact, Sensitivity Analysis.

## INTRODUCTION

The contribution of buildings to the overall environmental impacts of human activities has been significant and well-documented (EPA 2009, EIA 2015). According to the US Energy Information Administration (EIA 2015), 19% of the world's primary energy is consumed in the U.S. Buildings also contribute 40% to carbon dioxide emissions in the U.S. (EIA 2012) and near 66% of non-industrial solid waste generation (EPA 2009). The building sector in the U.S. constitutes approximately 44% of the total material use as well as roughly 1/3 of the total CO<sub>2</sub> emission identified as one of the main factors of greenhouse gas emissions (U.S.DOE 2002). Life Cycle Assessment LCA represents a quantitative tool for calculating the environmental impacts of buildings at all stages in their life cycle from cradle to grave. Throughout the life cycle of a building, various natural resources are consumed, including energy resources, water, land, and several pollutants are released back to the global/regional environment. These environmental burdens result in global warming, acidification, air pollution, etc., which impose damage on human health, natural resources, and biodiversity. There is no doubt that reducing the environmental burden of the construction industry is crucial to a sustainable world.

Many studies use LCA in assessing the environmental impacts of buildings. For example, Azari et al (2016) utilizes a multi-objective optimization algorithm to explore optimum building envelope design with respect to energy use and life cycle contribution to the impacts on the environment in a low-rise office building. Junnila and Horvath (2003) took the same path to quantify the most significant impacts of a high-end office in Europe. However, this study narrows down to the systems and materials that release most emissions for the studied case in order to test better retrofitting or fit out alternatives as building adapts to its future. Ragheb (2011) concluded that that the walls system has the highest percentage of emissions in building assembly systems, mainly in global warming, acidification, smog, and respiratory effect impacts in a comparative study of 3 office buildings. Tingley et al (2015) have used LCA at the level of construction materials to compare three different insulation materials when applied in a typical dwelling.

Building assembly systems (structural, envelope, floors, and roofs) in commercial buildings are rarely studied on individual or as combined systems in LCA studies. Thus, such information and data indicating the significant impacts by building assembly systems would be of great use in design and management of the building retrofit and maintenance

during its life cycle. The literature also supports that the design process, especially for office buildings, is a continuous process and the retrofit and building adaptation support this fact. Thus, LCA continues to help as a decision-making tool in this ongoing adaptive process of building management. This research findings support these flexible retrofits of systems, and/or materials, with less impacts alternatives.

## 1.0 RESEARCH METHOD AND ASSUMPTIONS

The life cycle assessment (LCA) framework is selected to analyze the environmental impacts of a new office building in the Midwest. Sixty years of use was assumed to be the basic life cycle. LCA is the most beneficial tool for the identification, quantification, and evaluation of the inputs, outputs, of environmental impacts of a product, process, or service throughout its life cycle, from cradle to grave i.e., from raw material acquisition through production and use to disposal [as defined in ISO 14040, 1997]. The LCA had three main phases; inventory analysis for quantifying emissions and wastes, impact assessment for evaluating the potential environmental impacts of the inventory of emissions and wastes, and interpretation for defining the most significant impacts.

LCA is defined as a holistic and systematic process to quantify the environmental burdens associated with a product or process. The process identifies and quantifies energy and material usage and environmental releases of the studied system and evaluates the corresponding impacts on the environment. Identification and quantification of material and energy flows (inputs and outputs) of the case study office building were obtained from the construction drawings and specifications and modeled using series of software listed below.

The quality of the data used in the life-cycle inventory was evaluated with the help of a six-dimensional estimation pedigree recommended by (Heijungs, et al. 2002). The quality target for the LCA was set to be at the level of “good,” which means reliability of a most recent documented data from actual drawings, specs sheets. In life-cycle impact assessment LCIA, the magnitude and significance of the energy and material flows (inputs and outputs) were evaluated. The impact categories included were those identified by EPA (2006) as ‘Commonly Used Life Cycle Impact Categories’. Among the 10 listed categories, the impact categories in this paper include:

- Primary Energy (Fossil Fuel Consumption) **FFC**,
- Resources Use **RU**,
- Global Warming Potential **GWP** (Climate Change),
- Acidification Potential **AP**,
- Eutrophication Potential **EP**,
- Human Health Respiratory Effect Potential **HHREP**,
- Photochemical Ozone Creation Potential **POCP**, or Summer Smog,
- Ozone Depletion Potential **ODP**.

The chosen impact categories are also on the short list of environmental themes that most environmental experts agree to be of high importance in all regions of the world and for all corporate functions (Schmidt and Sullivan, 2002). Furthermore, the used impact categories are consistent with the air and water emissions that the World Bank (1998) has recommended to be targeted in environmental assessments of industrial enterprises. The classification, or assigning of inventory data to impact categories, and the characterization, or modeling of inventory data within the impact categories (ISO 1997), were performed using the ATHENA 4.2 Impact Estimator (2014) which is used to model the building. The program filters the LCI results through a set of characterization measures based on the *mid-point impact assessment* methodology developed by the U.S. Environmental Protection Agency (U.S. EPA); the *Tool for the Reduction and Assessment of Chemical and other environmental Impacts* (TRACI) version 2.2. In the life-cycle interpretation section, the results are also examined from the building assembly systems (foundations, structures, walls, floors, and roof) so that the environmental impact of each system’s life cycle can be quantified.

### 1.1. Case Study Building Details

The case study is a new office building located in zone 5A (per ASHRAE’s classification) in the Midwest of the U.S. Its construction ended in 2014. The targeted use of the building is mainly offices. The building has 30,000 sq.ft. of gross floor area. The building consists of 3 floors above grade and a partial basement. The structural frame is steel W-sections with cast-in-place concrete foundations. The exterior walls are brick veneer with steel studs backing. Interior walls are galvanized steel studs with gypsum board facing to receive paint or wallpaper. The annual energy consumption (operational energy) is modeled/calculated using eQuest 3.65 (2016). The estimated natural gas consumption of the building is 0.1MBtu/sq ft/year (eq. 29 kWh/sq ft/year), mainly for water heating. The estimated electricity consumption is 513,000 kWh/year (17 kW.h/sq.ft/year), which is close to the average in such cold weather in Zone 5. In the study, the life cycle of the building was divided into 5 main phases; building materials manufacturing, construction processes, operation phase, maintenance, and demolition. Transportation of materials was included in each life-cycle phase through the software. The building materials phase included all of the transportation to the wholesaler warehouse. The construction phase included the transportation from the warehouse to the site.

## 1.2. Life Cycle Phases

**Materials Manufacturing:** The following building element categories were included in the study: foundation, structural frame (beams & columns), floors, external walls (envelope), and roofs. Some internal elements e.g., doors, partition walls, and suspended ceilings were modeled but results were separated from the main building assembly systems. The amount of each material used in the building was derived from the bill of quantities generated by the software. However, building modeling was mainly based on input from architectural and engineering drawings, and the architect's specifications.

**Construction Phase:** The construction phase of the building included all materials and energy used in on-site activities. Data were modeled for the use of electricity, construction equipment, and transportation of building materials to the site from an average radius of 100 miles.

**Operation Phase:** The use of the building was divided into mainly heating service (by natural gas) and electrical consumption. For the purpose of energy simulation, the building was estimated to be used 55 hrs/week for 60 years. Energy calculations were performed using eQuest 3.65, a DOE 2 energy simulation program for electricity use and HVAC heating and cooling loads. All building parameters (dimensions, orientation, walls, windows, etc) were modeled.

**Maintenance and Retrofit Phase:** The maintenance phase included all of the life-cycle elements needed during the 60 years of maintenance; use of building materials, construction activities, and waste management of discarded building materials. At the end of life, an estimated 75% of building materials was assumed to go to landfill, and 25% was assumed recovered for other purposes such as recycling.

**Demolition Phase:** The demolition phase included demolition activities on-site, transportation of discarded building materials (75% of the total) to a landfill (100 mi), and shipping of recovered building materials to recycling site (100 miles, on average).

## 2.0 CASE STUDY RESULTS AND INTERPRETATION

To interpret the results for the purposes of design management, an analysis of the result from the building assembly systems perspective is important. Hence, the life-cycle phases are divided into life-cycle elements, the elements belonging to different building assembly systems are grouped together, and the life-cycle impacts of each building system; foundations, walls, structure (columns and beams), roofs, floors, are calculated. Fig.1 shows that the environmental impacts of the office life cycle are divided into 5 building components systems. Three significant systems accounts for the highest environmental impacts of this building. These are structure (columns/beams), the wall system, and floors system respectively.

The results for all impacts had to be normalized per sq meter of building area for fair comparison. However, when comparing the life cycle impacts of assembly systems, it was surprising to find that the wall system has huge impact comparable to building structures and floors. This happen in most impact categories (FFC, GWP, AP, EP, POCP, HHREP). In this study (Fig.1), the result was primarily due to increasing the wall insulation thickness to increase energy efficiency and to comply with ASHRAE 90.1-2007 code. Both fiberglass batt insulation (in the stud cavity) and continuous rigid insulation used (extruded polystyrene XPS), albeit high in R-value per inch (R3 and R5 per inch respectively), both have high embodied energy and have huge emissions during their manufacturing process. Insulation also covers the surface area of the wall and roof systems forming the building enclosure. The other material, causes this huge wall impact, is structural steel (with its massive embodied and transportation energy). These results made energy consumption (embodied + transportation energy) the most dominant impact category in the whole assembly (Fig.1). Resources use is the highest in foundations and floors systems due to the massive concrete weight and wide area both systems cover. GWP is more in walls and roof respectively (due to insulation emissions) than structure. AP is the highest impact in walls assembly due to some materials such as gypsum boards, fiberglass insulation, and vapor barriers which release Sulphur dioxide (SO<sub>2</sub>) and Nitrogen oxides (NO<sub>x</sub>) during manufacturing that contribute to acid rain formation when released to the environment.

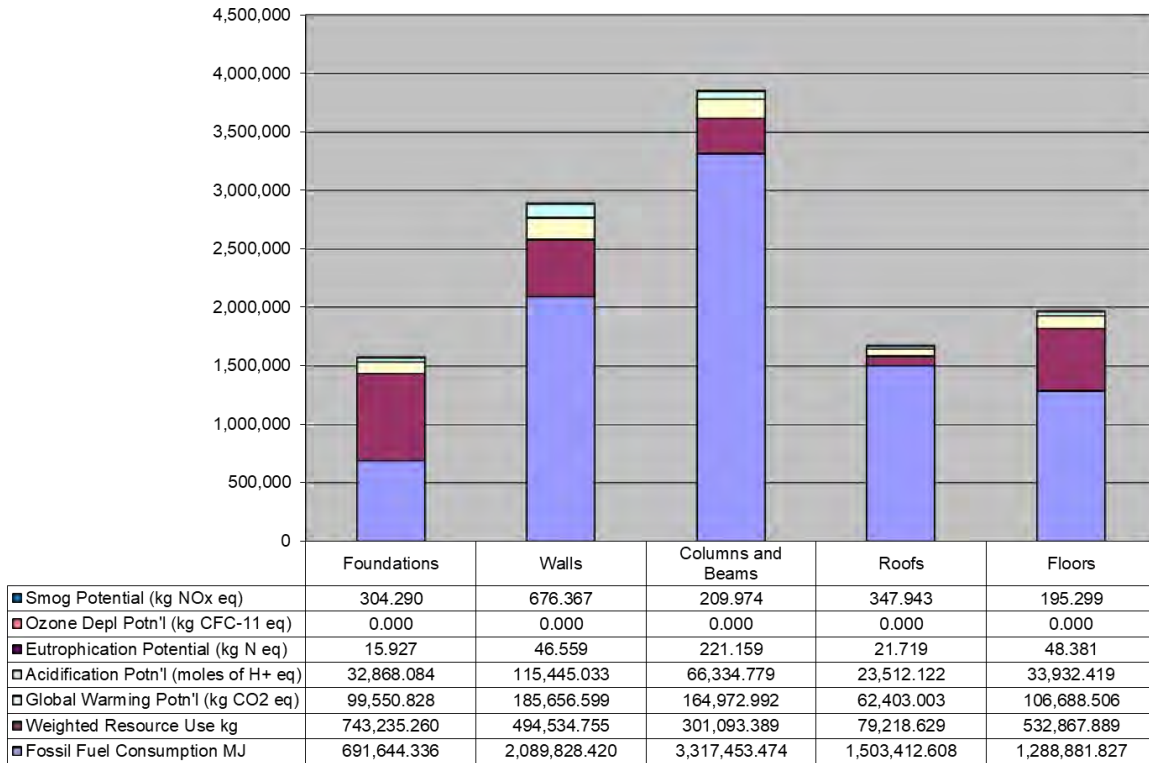


Fig. 1: Environmental Impacts by Building Assembly Systems

### 3.0 RETROFIT SCENARIO ANALYSIS

Sensitivity analysis is typically used to check either the significance of changing key parameters contributing to the overall LCA or key assumptions governing the methodology of the LCA itself. The *what if* scenario is used for sensitivity analysis according to Pesonen et al. (2000). Sensitivity scenarios are used to compare the replacement of materials that have high impacts within the building with more low impact alternatives, and then quantify these changes in the environmental impacts again at the end of the 60 years. From the previous results, the study found that materials such as insulation (batt and rigid) and vapor barrier have huge area, quantities, and potential high impact in many categories. Therefore, *wall* materials were replaced with more low-impact alternatives, then the total impacts are assessed again with these new materials to test how much reduction to the results was achieved. The other systems (foundations, structure, floors) are not changed in this analysis because they are fixed systems (cannot be changed) once building is erected. The wall system is chosen because it represents the highest impacts share by building systems next to structure (Fig. 1). This is consistent with ISO 14043 (1998) to “asses the sensitivity of data elements that influence the results most greatly”.

Table 1: Walls Retrofit Scenario Analysis

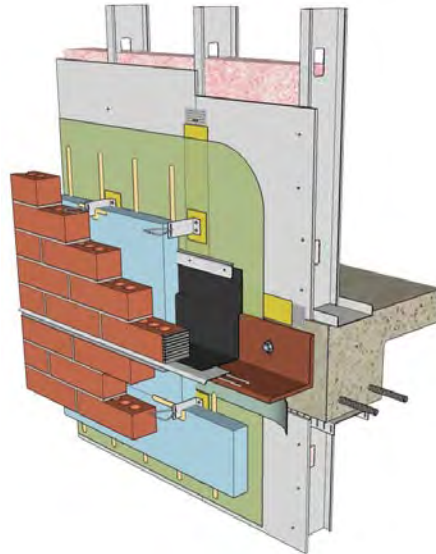
	Stud Cavity Insulation	Continuous Insulation
<b>Existing</b>	6" fiberglass batt insulation w/ R-19	1.5" extruded polystyrene (XPS) w/R-8
<b>Retrofit</b>	6" cellulose batt insulation w/ R-19	2" foil-faced expanded polystyrene (EPS) w/R-8

#### 3.1. Retrofits Assumptions Scenarios

A list of changing variables included in the analysis is shown in (Table 1). The main assumptions for retrofitting was to try alternatives for the wall system since it showed the second highest impact among assembly systems (Fig.1). Expanded polystyrene (EPS) insulation proved to be more environmentally friendly, dries up faster, and retains its R-value longer after exposure to moisture. It gives comparable R-value over similar extruded polystyrene (XPS) insulation but with less environmental impact due to its recycling nature. Since XPS is more durable than EPS, it is important to mention that although durability plays a factor in wall design, it was normalized here (having identical R-value) for the sake of testing and comparing the impact of the 2 alternatives. Insulation replacement is suggested to take place 2



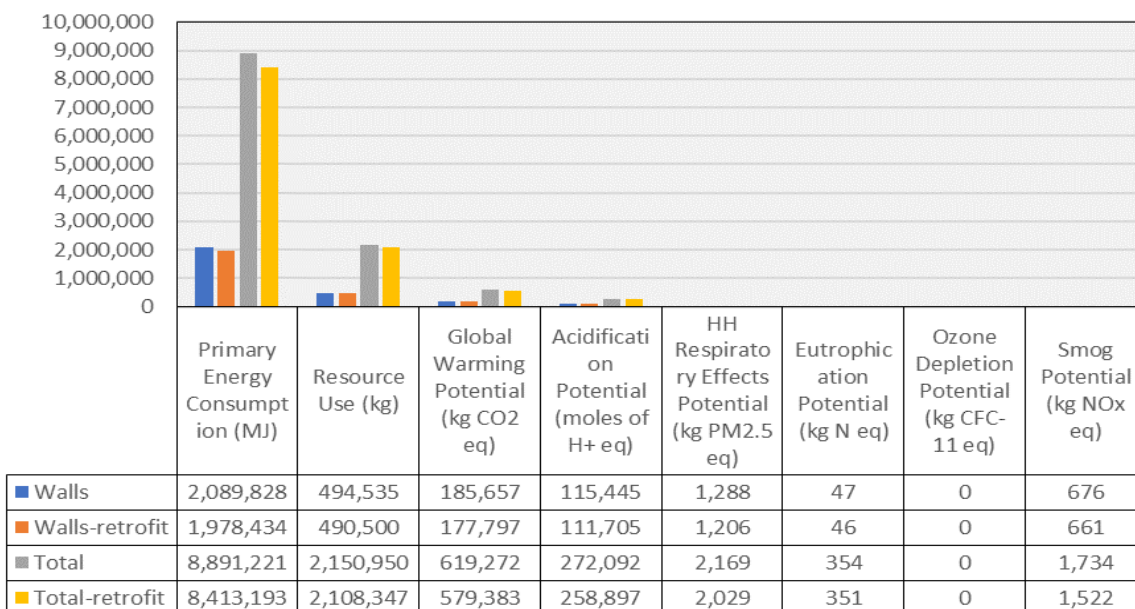
times during 60 years of life (every 30 years). This seems quite reasonable assumption since the life expectancy of an ordinary insulation is around 30 years. Suggested changes are to replace the 6" fiberglass insulation + 1.5" XPS with 6" cellulose insulation (to give the same R-value) + 2" EPS insulation. (Fig. 2) illustrates wall systems assembly prototype used in this case study. Insulation materials chosen to have the most quantity of the wall system due to coverage (surface) area and their possible high emissions during manufacturing. Other materials such as steel studs, fasteners, gypsum board were similar in both comparative assemblies.



**Fig. 2:** The typical wall system used and its components  
(courtesy of Construction Specifier, Construction Specifications Institute CSI)

### 3.2. Retrofit Sensitivity Results

Figure 3 shows results of all impact categories by building assembly systems. The two scenarios are the *existing* calculations scenario and the *retrofit* scenario. Results show that sensitivity scenario with alternative materials has reduced values in all impact categories due to the change of insulation and membrane (Table 1). These reductions range between 6% and 15% in the 8 different impact categories this study has investigated. The retrofit sensitivity also highlights the importance of wall insulation as sensitive materials that have huge quantities within a building. They significantly reduce the whole impacts if chosen carefully by architects.



**Fig. 3:** Environmental Impacts Reduction Due to Retrofitting

## CONCLUSION

The purpose of the study is to quantify and compare the environmental impact caused by an office building's enclosure systems. The study examined the building assembly components that most contribute to its life cycle impact. The study found that wall system to have significant environmental impacts due to the use of insulation and vapor barriers materials. Using more environmentally friendly materials (cellulose batt insulation + expanded polystyrene EPS continuous insulation) in wall assembly rendered a reduction of 6% -15% in different impact categories throughout the entire life cycle. Using EPS with foil facing reduced the annual energy consumption of the building by 11% over 60 years which in turn reduced the total impact. Results have shown the importance of LCA as tool to choose better alternatives during the maintenance and retrofit phase of an office building. Some limitation on impacts include office furniture, computers, construction of infrastructure are not assessed due to the limitation of the modeling software. These were excluded to focus on modeling the building assembly systems not the interior furniture.

LCA results demonstrated that the case study building has overall slightly below average energy consumption rate for an office building in the U.S. This is mainly due to a tighter enclosure. One shortcoming though was the use of XPS and fiberglass insulation without considering the high environmental impact of using such alternatives. This resulted in that the wall system had the highest impact in most categories. The LCA method helped to narrow down to this high-impact system and material choices used (e.g. batt and rigid insulation). Hence, even an energy efficient building complying with code could have a reverse huge impact due to using high-impact materials within its assembly systems. This results in an overall annual energy savings but reversibly has significant high impact of materials that achieve this saving.

One of the limitations of the study relates to the single-case study method used, because wider generalization based on a single case is not possible. However, the results of the study can be interpreted together with the results from previous studies. The findings of this study support previous arguments that operation energy is a major environmental issue in the life-cycle of an office building, and that some building materials e.g. insulation also have significant impact. This is typical for an office building in the U.S. For other countries, it is more difficult to generalize based on the results of this study. There are many regional conditions used in the calculations that could affect considerably the results outside the U.S. Building design, intensity of materials, construction methods, and intensity of energy use in the operation phase are all different. Most importantly, there are differences in electricity generation and energy use (grid mix) especially if a higher proportion of coal is burned in the power plant like the case in the United States. Many other countries that use higher percentage of electricity from hydro power (almost no emissions) and non-fossil fuels. Such grid systems affect the final emissions especially the release of CO<sub>2</sub>, SO<sub>2</sub>, and NO<sub>x</sub> to air. The study is also unique in modeling the building with the U.S. electricity grid which depends on coal as a resource at 25% (DOE, EIA 2020).

## REFERENCES

- ATHENA, Impact Estimator 4.2 (2014). Athena Sustainable Materials Institute, Morrison Hershfield Consulting Engineers. Ottawa; Merrickville, Ontario, Canada.
- Azari, R., Garshasbi, S., Amini, P., Rashed-Ali, H., Mohammadi, Y. (2016). Multiobjective optimization of building envelope design for environmental performance. *Energy and Buildings* 126. pp. 524-534.
- eQuest 3.65 (2016), USDOE interface, the QUick Energy Simulation Tool (eQuest) [software tool]. Available from: <http://www.doe2.com/equest/>
- Heijungs, R. and Suh, S. 2002. Computational Structure of Life Cycle Assessment. Kluwer Academic Publishers, The Netherlands.
- ISO. (1997). "Environmental management, life cycle assessment, principles and framework." *SFS-EN ISO 14040*, Geneva.
- ISO 14043 (1998). *Environmental Management – Life Cycle Assessment - Life Cycle Interpretation*. International Organization for Standardization, Geneva, Switzerland
- Junnila, S. and Horvath, A (2003). "Life-cycle environmental effects of an office building". *Journal of Infrastructure Systems*, Vol. 9, Iss. 4, pp. 157-166.
- Pesonen, H.L., Ekvall, T., Fleischer, G., Huppel, G., Jahn, C., Klos, Z., Rebitzer, G., Sonnemann, G., Tintinelli, A., Weidema, B. P. and Wenzel H. (2000). Framework for scenario development in LCA. *International Journal of Life Cycle Assessment*, Vol. 5, No. 1, pp. 21-30.
- Ragheb, A. (2011). "Towards Environmental Profiling of Office Buildings Using Life Cycle Assessment", A PhD dissertation, University of Michigan, Ann Arbor.
- Tingley, D., Hathway, A., Davison, B. (2015). *An environmental impact comparison of external wall insulation types*. *Building and Environment*, 85: 182-189.
- U.S. Department of Energy. (2002). "Why is sustainable building important?" Technical Rep., [<http://www.ecy.wa.gov/programs/swfa/cdl/Benefits.htm>], Washington Department of Ecology, Washington, D.C.
- U.S. DOE, Energy Information Administration EIA (2020), Electric Power Industry 2020: Year in Review [<https://www.eia.gov/outlooks/aeo/pdf/AEO2020%20Electricity.pdf>], (accessed Jan 2021).
- U.S. EPA, Env. Protection Agency (2009). Buildings and the Environment: a Statistical Summary. <http://ww2.harford.edu/faculty/eaugusti/Environ%20Health/green%20building%20stats.pdf>
- U.S. EPA, Env. Protection Agency (2006), *Life Cycle Assessment: Principles + Practice*, EPA/600/R-06/060 May 2006.
- U.S. EPA, Env. Protection Agency (1993), *Life Cycle Assessment: Inventory Guidelines and Principles*, EPA/600/R-92/245
- World Bank. (1998). "Industrial estates, pollution prevention and abatement handbook." *Draft Technical Background Document*, Environmental Dept., Washington, D.C.

# Cost-Effective Net-Zero Energy Retrofit Measures for Existing Buildings in Cold Climates

Hossam Mahmoud<sup>1</sup>, Ajla Aksamija<sup>1</sup>

<sup>1</sup>University of Massachusetts, Amherst, MA

**ABSTRACT:** Buildings consume 44% of the energy in the U.S. New construction buildings now must abide by stringent building codes, however half of the U.S. buildings were constructed before 1980, when building energy standards were not as stringent. The annual replacement rate of existing buildings by new buildings is only around 1 to 3%. Meanwhile, commercial buildings account for 19% of the total energy used by buildings in the U.S. This study focuses on net zero cost optimization of existing commercial office building in the U.S., particularly in cold climates. The study defined a standardized methodology for optimizing retrofit net zero energy commercial buildings using computer simulation-based optimization and focused on Boston's climate. The multi-parameter optimization considered various options for building envelope parameters, heating, cooling and ventilation systems as well as various sources of renewable energy. The study identified the cost optimal design solutions for typical commercial buildings in this climate. The study is expected to be a guide during conceptual design phase for designers and builders, and to help policy managers, energy efficiency program administrators to identify future energy efficiency measures and renewable energy technologies to support to achieve the net zero energy targets.

**KEYWORDS:** Net-zero buildings, Retrofit, Deep Retrofit, Energy Efficiency, Commercial buildings

## INTRODUCTION

The U.S. Energy Information Administration predicts a 28% increase in global energy consumption by 2040. Fossil fuel demand is expected to grow slower than non-fossil fuels but will still account for more than three-quarters of world energy consumption through 2040 (International Energy Outlook 2017) Such dependence on a limited non-renewable resource will result in increased fossil fuels costs in the future, which will impact the national security of energy importing countries and their global market competitiveness. In addition, the increase in fossil fuel use will further contribute to greenhouse gases in the Earth's atmosphere, causing additional climate change effects that will have future environmental, political and economic implications (Perera 2016).

Buildings make up about 44% of the energy used in the US (International Energy Outlook 2017). An estimate of fifty percent of existing buildings in the U.S. were constructed before 1980 (EIA: CEBCS database, 2012). The annual replacement rate of existing buildings by new buildings is only around 1 to 3% (Zhenjun et al. 2012). Retrofitting existing buildings to be more efficient could result in \$1 trillion of energy savings over the next 10 years (Fulton 2012). The Architecture 2030 Challenge has driven architectural, engineering and construction industry to commit to adopting the goal of reducing the overall energy usage with the target of having net zero energy buildings. Also, more U.S. states and cities are adopting the Challenge, such as the state of California and the City of Cambridge, aspiring to achieve net zero-energy for new construction and major renovations.

Net-zero energy buildings (NZEB) have several definitions. Researchers at the National Renewable Energy Laboratory (NREL) have analyzed the policy and design implications of four common definitions: net-zero annual site energy, net-zero annual source energy, net-zero annual energy cost and net-zero annual emissions (Carlisle, Geet, and Pless 2009). The net-zero annual site energy is the most common type, and includes buildings that are able to produce on-site energy as much as they consume on an annual basis. Buildings can use the electric grid or other fuels, but will need the on-site production of similar amount of energy. The net-zero source energy is more complicated, and it involves the losses that occur at source and during transmission. For example, one unit of electricity at site needs three units at source due to the inefficiencies in production at source and transmission. The net-zero annual cost is based on the idea that the purchased energy is from renewable sources, but the on-site renewable systems are not needed. The net-zero annual emission follow a different concept than previous definitions; no energy production is needed on site. Net-zero emissions can be achieved by purchasing power from a renewable source (RECS) to offset the usage even if the building is not very efficient it still can be achieved.

Increasing energy efficiency goals and NZEB targets requires designing and operating buildings using novel and innovative approaches. The increased importance of building design and operation has amplified the need for evaluating various design options. Manual optimization of design parameters is extremely inefficient and time

consuming (Malin and Boehland 2005). Building geometry, envelope and systems interact, thus requiring the optimization of building design parameters and systems rather than system design on an individual level (Hayter et al. 2001). Building optimization tools have become more readily available and used in several research studies to automate the optimization of building design (Coello and Lamont 2004). The building optimization tools are usually coupled with a building simulation tool or integrated, where users set a single or multi-objective parameters. This method can be used to find solutions and designs that would satisfy several desirable qualities, considering building geometry, structure, comfort, energy conservation or economic features (May-Ostendrop et al. 2011, Corbin, Henze, May-Ostendrop 2013, Candanedo and Athienitis 2011, Hensen, Lamberts and Negrao 2002).

The goal of this study was to analyze commercial office buildings and investigate cost-effective retrofit methods for reaching net-zero energy goals. Research methods included simulations of a common office building prototypes in Boston climate to establish a baseline energy usage, and multiple simulations of low-impact, deep retrofit strategies and on-site renewable energy to find optimal net-zero design. The following research questions were addressed:

- What are the characteristics of existing office buildings in Northeast U.S.?
- What is the baseline energy usage for existing office buildings in the Northeast?
- What are cost-effective design methods for commercial office buildings in cold climate to achieve net zero energy?

## 1.0 LITERATURE REVIEW

NZEB optimization using simulations and optimization software to automate the optimization process has been researched in recent years. Kurnitski et al. researched cost optimal solutions for residential and office buildings (2013). In the case of office buildings, they concluded that a construction concept with a specific heat loss of  $0.33 \text{ W}/(\text{K m}^2)$  and district heating at around  $140 \text{ kWh}/(\text{m}^2 \text{ a})$  is the cost-optimal solution (Kurnitski et al. 2013). The low heat loss shows that in colder climates insulation plays an important part in achieving net zero energy. The authors included labor costs, material costs, overheads and value added tax in the energy performance-related construction costs. They did not, however, take into account maintenance, replacement and disposal costs, as these had a minimal impact on net present value (NPV). Pikas et al. researched cost optimal zero energy buildings solution for offices (2014). Cost effectiveness of high-performance facade solutions was analyzed, and smaller triple glazing and 200 mm insulation was cost optimal in a cold climate, with most economic NZEB was achieved with cost optimal façade and photovoltaic panels. The study deducted that higher energy prices and reduced investment costs can make NZEB cost optimal (Pikas et al. 2014).

Congedo et al. developed a methodological framework to identify cost-optimal solutions in warm climates for new construction office buildings (2015). The cost-optimal configuration obtained from a financial analysis presents  $60.99 \text{ €/m}^2$  cost reduction from the reference building. The cost-optimal configuration deriving from a macroeconomic analysis shows a global cost lower than  $62.4 \text{ €/m}^2$  (Congedo et al. 2015).

Model input parameters can influence results, such as reference building properties and climatic conditions, as investigated by Leutgob et al. (2014). Kapsalaki and Santamouris developed a methodology using MATLAB for cost effective design of residential buildings, the methodology was tested in three climates (2011). The study concluded that the most expensive NZEB design had three times more expensive initial cost than the cheapest design solution. The study showed that mild winter climates have significantly cheaper optimal NZEB compared to cold winter climates (Kapsalaki and Santamouris 2011). Research also shows that a PV system plays a key role in nearly and net zero building energy balance (Becchio et al. 2015).

A multi-stage methodology to optimize design for single-family houses has been developed. The method takes into consideration heating/cooling systems, energy envelopes, costs, energy efficiency measures and renewable energy sources to find the optimal design (Hamdy, Hasan and Siren 2013). Hasan et al. combined simulation and optimization to minimize the life-cycle cost (LCC) of a single-family detached house. The study investigated a wide range of wall, roof, and floor insulation levels, two types of windows, and two types of ventilation-heat recovery units. However, no heating alternatives were addressed (Hasan et al. 2008). Alanne et al. (2007) considered the selection of a residential energy-supply system as a multi-criteria decision-making problem involving both financial and environmental issues. The study analyzed the competitiveness of micro-CHP as 1 of 10 alternative heating systems for a Finnish single-family house. The analysis showed that the micro-CHP is a reasonable alternative to traditional systems, particularly from the environmental point of view. (Alanne et al. 2007).

Hakrous et al. investigated multi objective for net zero design building in different climate zone in Lebanon and Paris (2017). They developed a methodology that uses non-dominated sorting genetic algorithm in order to minimize thermal, electric and life cycle cost (LCC). These studies cannot be applied to office buildings, as residential buildings serve a different function and have different performance characteristic, but the methods developed can be used as a reference (Hakrous et al 2017).

Mohamed et al. developed a methodology to assess the performance of net zero energy office buildings in Finland (2015). Small scale generation technologies were investigated to achieve cost optimality. Biomass CHPs with high

overall efficiency and low P/H ratio are economically viable. Extending the cost-optimal solutions by PV system yields NZEB with minimum LCC. In this study, 143 building EEM combinations are proposed to improve the energy performance of the pre-defined reference office building. The proposed building EEMs are categorized into building envelope measures and building service system package (BSSP). The building envelope measures include (i) insulation level of external wall, (ii) window type, (iii) infiltration level. The building was modeled on using IDA-ICE software and Matlab for post processing of the annual demand and life cycle cost analysis and renewable energy implementation (Mohamed et al. 2015).

Bucking et al. have used automated building optimization to quantify economic risks (2013). They used a genetic algorithm coupled with EnergyPlus to reach the optimal designs, and a Monte Carlo analysis was used to quantify the economic risk. The economic risk is not positively correlated to decreasing net energy use intensity as one might expect. This is likely due to the income generating potential of PV, which moderates the added technology costs throughout the life cycle (Bucking, Zmeureanu, and Athienitis 2013).

The existing research is mainly focused on new construction residential and office buildings in Europe. The research showed that achieving optimal cost design during the building life cycle for NZEB is possible in most cases, albeit in some cases financial incentives will be needed. The existing research did not feature a standardized research procedure; a variety of different manual iterations, methods and software packages have been used, such as MATLAB coupled with EnergyPlus, BEopt, and TRNSYS coupled with MOBO. Most research did not compare multiple renewable energy sources, and did not consider CHP measures.

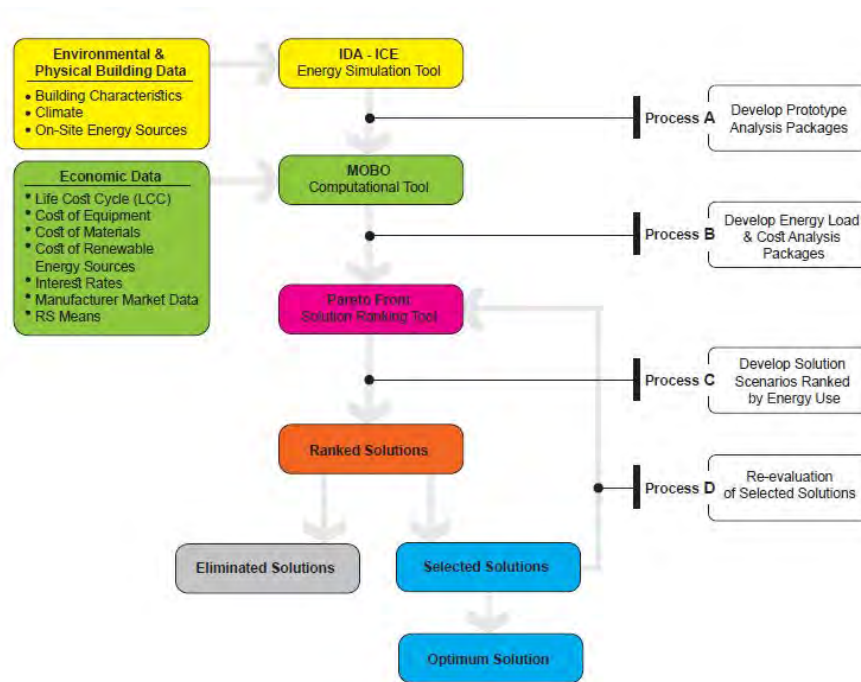
The existing research demonstrates that in most cases the most efficient design solution is not the cost optimal solution, and an optimization is between the cost of additional energy efficiency measures and renewable energy generation.

## 2.0 METHODOLOGY

Due to many challenges, practitioners are hoping to be able to use design guides and simpler tools in the conceptual design phase to be able to optimize NZEB designs (Attia, S 2013 ). While many NZEB building optimization design studies target residential sector, commercial buildings represent 19% of U.S. energy usage (International Energy Outlook 2017). This study focuses on commercial office NZEB retrofit design optimization in the U.S., considering net-zero energy site approach.

The research methodology process is shown in Figure 1. The initial step was to determine characteristics of existing commercial buildings, and to determine baseline energy consumptions. Commercial Building Energy Consumption Survey (CBECS) database was used to determine characteristics of typical commercial office buildings, including area, building systems, materials, construction methods, etc. (EIA: CBECS database, 2012). The mean area for office buildings in the U.S. varies between 929 m<sup>2</sup> to 2,322 m<sup>2</sup> (EIA: CBECS database, 2012). Office building models used for simulations in this study considered a building with 1,858 m<sup>2</sup> floor area (to represent the average floor area of the existing office building stock). The baseline considered for existing office buildings was a square shape geometry. CBECS commercial building data was used to analyze and determine the most common building components and materials in the Northeast region of the U.S. Building characteristics that were considered include:

- Building frame
- Exterior wall construction materials and components
- Roof construction materials and components
- Natural air infiltration
- Window to wall ratio
- Internal and external shading



**Figure 1:** Methodology to optimize NZEB.

The most common building equipment were determined using CEBECS database and local codes. Building equipment characteristics included:

- HVAC equipment characteristics
  - Heating equipment type and size
  - Cooling equipment type and size
  - Ventilation equipment type and size
  - HVAC controls
- Lighting system characteristics
  - Lighting type and intensity
  - Lighting controls
- Miscellaneous loads
  - Electronic equipment types and quantity.

After the baseline building's characteristics and equipment were established, IDA-ICE simulation software program was used to model existing building's baseline, shown in Figure 2. Moreover, several energy efficiency packages were identified and established. The energy-efficiency measures considered changes to one or more of the building parameters, such as building envelope design, HVAC system, lighting, etc. The site and roof information were defined on IDA-ICE to determine the on-site energy generation of solar photovoltaics and wind power. Building parameters used are as follows:

- Wall R-value
- Roof- R-Value
- Windows
- ACH
- Lighting
- Plug Loads controls
- Shading
- Heating Plant
- Cooling Plant
- ERV
- EMS controls
- Night Setback
- Photovoltaics
- Wind Turbine



Lastly, the cost of high efficiency equipment, material and renewable energy systems was obtained from manufacturers, market research and RS means. The existing interest rate, energy prices (adjusted for future inflation) was used for optimization. MOBO tool was then coupled with IDA-ICE for optimization with the objective of optimal cost NZEB designs. The MOBO tool produced a Pareto Front with multiple solutions. The solutions were ranked based on primary energy use and cost.

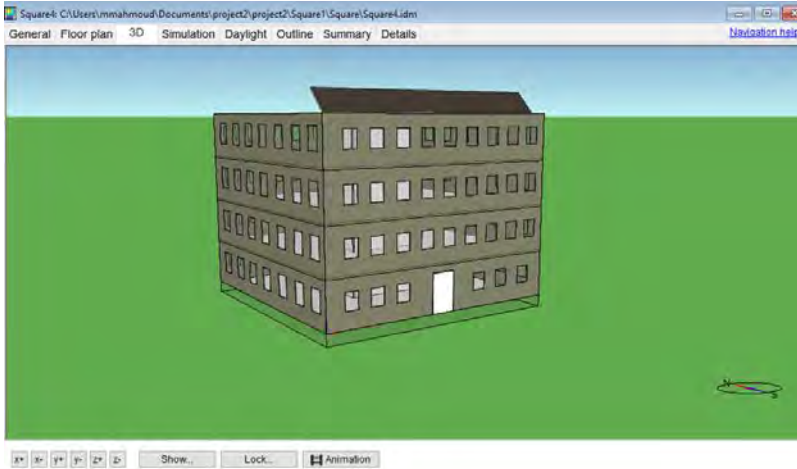


Figure 2: Building model in IDA ICE.

### 3.0 RESULTS

A total of 600 simulations were run using MOBO and IDA ICE software. The simulation resulted in 63 net-zero energy solutions. The simulation results are divided into three main categories, shown in Figure 3. The results were categorized based on the considered retrofit strategies. The low impact strategies also resulted in lower costs. The second category includes deep retrofit strategies that had a significant impact on decreasing the building energy use beyond the no cost and low-cost measures. These measures have the tendency to be higher in cost. Lastly, the deep retrofit measures, coupled with renewable energy sources, would reach net-zero energy goals (or neat net-zero).

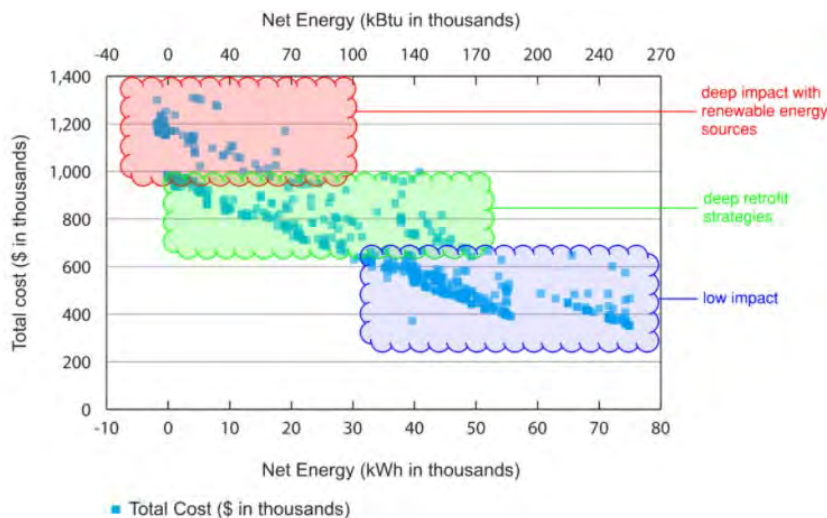
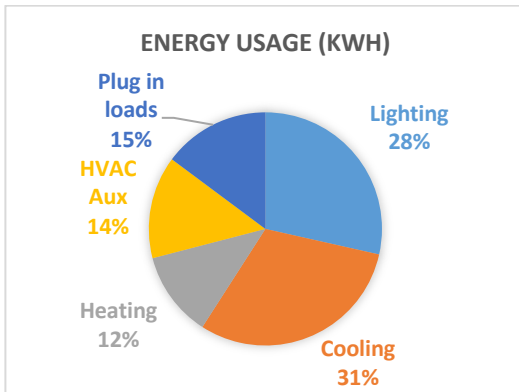


Figure 3: Modelling results, indicating cost-implications of different design strategies.

The 63 net-zero simulations were ranked by cost. The optimum solution was the solution that achieved ne-zero energy goals at the lowest cost. The optimum solution energy usage breakdown is shown in Figure 4. The breakdown shows that improvements in building weatherization and building controls, in addition to existing building's internal loads, have resulted in the building being cooling-dominated despite being located in a heating dominated climate.

Moreover, it shows significant plug load energy use. As shown in Table 1, the plug load controls were used in optimum design to minimize plug load use.



**Figure 4:** Optimum solution energy breakdown.

Measure	Baseline	Optimum Design
Wall RSI-value	1.5 $m^2 \cdot K/W$	3.1 $m^2 \cdot K/W$
Roof- RSI-Value	2.6 $m^2 \cdot K/W$	7.5 $m^2 \cdot K/W$
Windows	double pane windows	Triple pane argon Window
ACH	0.4	0.2
Lighting	Florescent Lighting	LED Lighting and controls
Shading	No Shades	No Shades
Heating Plant-	Standard efficiency gas boiler	High Efficiency VRF system
Cooling Plant	Standard efficiency RTU	High Efficiency VRF system
ERV	No existing ERV	Counter Flow ERV
EMS controls-	Basic standalone control	EMS w/ DCV
Night Setback	No night setback	Implement Night Setback
Photovoltaics	0 $m^2$	297 $m^2$
Wind Turbine	0 $kW$	0 $kW$
Plug Loads controls	No existing controls (10W/ $m^2$ )	Controls added

**Table 1:** Baseline and optimum solution building parameters.

The optimum design solution parameters in Table 1 show that improvements in lighting, HVAC and building controls are essential to reach net-zero energy goals. Maximum roof insulation R-value was utilized, however the wall RSI-value optimum design was at RSI-3.1  $m^2 \cdot K/W$  compared to a maximum wall insulation of RSI-3.7  $m^2 \cdot K/W$ . Additionally, the building air sealing was improved from 0.4 ACH to 0.2 ACH. Windows needed improvement to the best available windows parameter utilizing triple pane Aragon windows. HVAC was upgraded to high efficiency VRF system with the addition of ERV for ventilation. Building controls were also improved from standalone controls with no setback to an energy management system with demand control ventilation (DCV). In addition to the energy management system controlling the HVAC system, lighting control with day light harvesting capabilities and plug load control were added. Lighting was upgraded to LED from fluorescent. Shading, however, was not added to the optimum design.

The 63 solution shows that shading was required in 61 out of the 63 solution to reach net-zero energy goals. Nevertheless, adding shading add significant cost to the project, resulting in less than optimal design.

## CONCLUSION

Using multi-parameter optimization to asses and identify optimal net-zero solutions for office retro-fit buildings results in the identification of multiple net-zero building solutions. Utilizing IDA ICE coupled with MOBO provides a methodology where simulation can be run using a set of boundaries to identify the Pareto front. The results show that achieving net-zero energy goals in commercial office buildings is possible, but with significant building improvements and implementation of deep retrofit strategies. In Boston's heating dominated climate, improvements in weatherization and building temperature controls are critical to achieve net-zero goals. Moreover, controls for lighting and plug loads are necessary. The simulations demonstrated that without building controls achieving net-zero energy was not

possible. Shading on the other hand was not essential in a heating dominated climate. This might not be the case in hotter climates. Additional research and simulation will be conducted for mixed and hot climates. The optimum design is expected to change with the change of dominant loads. Additionally, behavioural impact on retrofit net-zero buildings performance should be assessed in future research.

## REFERENCES

- Alanne, K., Salo, A., Saari, A. and Gustafsson S. 2007. *Multi-criteria Evaluation of Residential Energy Supply Systems*. Finland: Energy and Buildings 39.
- Attia, S., Hamdy M., O'Brien W., and Carlucci, S. 2013. *Assessing Gaps and Needs for Integrating Building Performance Optimization Tools in Net Zero Energy Buildings Design*. Switzerland: Energy and Buildings 60.
- Bucking, S., Radu, Z., and Andreas A. 2013 *An Information Driven Hybrid Evolutionary Algorithm for Optimal Design of a Net Zero Energy House*. Canada: Solar Energy 96.
- José, C., and Andreas, A. 2011. *Predictive Control of Radiant Floor Heating and Solar-source Heat Pump Operation in a Solar House*. Canada: HVAC&R Research 17.
- Becchio, Cristina, Dabbene, P., Fabrizio, E., Monetti, V., Filippi, M. 2015. *Cost Optimality Assessment of a Single Family House: Building and Technical Systems Solutions for the NZEB Target*. Italy: Energy and Buildings 90.
- Congedo, M., Baglivo, C., Dagostino, C., and Zacà, I. 2015. *Cost-optimal Design for Nearly Zero Energy Office Buildings Located in Warm Climates*. 2015. Italy: Energy 91.
- Coello, C. , and Lamont, B. 2004. *An Introduction To Multi-Objective Evolutionary Algorithms And Their Applications*. Mexico: Applications of Multi-Objective Evolutionary Algorithms Advances in Natural Computation.
- Corbin, C., Henze, G., and May-Ostendorp, P. 2013. *A Model Predictive Control Optimization Environment for Real-time Commercial Building Application USA: Journal of Building Performance Simulation* 6.
- Fulton, M. 2012. *United States building energy efficiency retrofits market sizing and Financing Models March 2012*. USA: Rockefeller Foundation.
- Hamdy, M., Hasan, A., and Siren, K. 2013. *A Multi-stage Optimization Method for Cost-optimal and Nearly-zero-energy Building Solutions in Line with the EPBD-recast 2010*. Finland: Energy and Buildings 56.
- Hasan, A., Vuolle, M., and Sirén, K. 2008. *Minimisation of Life Cycle Cost of a Detached House Using Combined Simulation and Optimisation*. Finland: Building and Environment 43.
- Harkouss, F., Fardoun, F., and Biwole, P. 2018. *Multi-objective Optimization Methodology for Net Zero Energy Buildings*. France: Journal of Building Engineering 16.
- Hensen, J., Lamberts, R., and Negrao, C. 2002. *Building Performance Simulation at the Start of the 3rd Millennium*. USA: Building and Environment 37.
- Kurnitski, J., Saari, A., Kalamees, T., Vuolle, M., Niemelä, J. and Tark, T. 2013. *Cost Optimal and Nearly Zero Energy Performance Requirements for Buildings in Estonia*. Estonia: Estonian Journal of Engineering 19
- Kapsalaki, M., Leal, V., and Santamouris, M. 2011. *A methodology for economic efficient design of net zero energy buildings*. Portugal: Energy Build, 43.
- Leutgob, K., Pagliano, L., and Zangheri, P. 2014. *Cost-optimality – brake or accelerator on the way towards nearly zero energy buildings*. European union: European council for an energy efficient economy (ECEEE) proceedings.
- May-Ostendorp, P., Gregor, P., Henze, C., Corbin, D., Rajagopalan B., and Felsmann, C. 2011. *Model-predictive Control of Mixed-mode Buildings with Rule Extraction*. USA: Building and Environment 46
- Zhenjun, M., Cooper, P., Daly, D. and Ledo, L. 2012. *Existing Building Retrofits: Methodology and State-of-the-art*. Australia: Energy and Buildings 55.
- Ayman, M., Hamdy, M., Hasan, A. and Sirén, K. 2015. *The Performance of Small Scale Multi-generation Technologies in Achieving Cost-optimal and Zero-energy Office Building Solutions*. Applied Energy 152
- Nadav M., and Boehland, J. 2005. *Getting to Zero: The Frontier of Low-Energy Buildings*. Finland: Environmental Building News volume 14.
- Perera, F. 2016. *Multiple Threats to Child Health from Fossil Fuel Combustion: Impacts of Air Pollution and Climate Change*. USA: Environmental Health Perspectives 125.
- Pikas, E., Thalfeldt, M. and Kurnitski J. 2014. *Cost Optimal and Nearly Zero Energy Building Solutions for Office Buildings*. Finland: Energy and Buildings 74.
- Hayter, S., Torcellini, P., Hayter R. B., Judkoff, R. 2001. *The Energy Design Process for Designing and Constructing High-Performance Buildings* Italy: Clima 2000/Napoli 2001 World Congress.
- “International Energy Outlook 2017.” Data Accessed January 19, 2021. [https://www.eia.gov/outlooks/ieo/pdf/0484\(2017\).pdf](https://www.eia.gov/outlooks/ieo/pdf/0484(2017).pdf)
- “U.S. Energy Information Administration - EIA - Independent Statistics and Analysis.” Energy Information Administration (EIA)- Commercial Buildings Energy Consumption Survey (CBECS) Data. Accessed January 19, 2021. <https://www.eia.gov/consumption/commercial/data/2012/>.



# Assessment of Deep Façade Retrofit Solutions for Housing

Ming Hu<sup>1</sup>

<sup>1</sup>University of Maryland, College Park, MD

**ABSTRACT:** Knowledge and research tying the environmental impact to operating energy efficiency improvement is a largely unexplored area in higher performance retrofit projects. It is a challenge to choose the façade renovation option that represents the optimal trade-offs among different performance objectives. This paper aims to test a multi-objective envelope optimization method to quantify and compare the deep retrofit façade techniques and their induced environmental impact. An integrated life cycle energy (LCE), life cycle assessment (LCA) and thermal comfort model (TCM) framework is proposed and used. Seven building façade retrofit options were studied to evaluate the operating energy saving, embodied energy increase and potential environmental impact. This project aims to better understand the pros and cons and trade-offs of different façade renovation options. The analysis results shows three findings: (a) the building construction method and the materials play equally important roles in the environmental impact; (b) the life cycle approach highlights the fact that energy saving alone is not sufficient when comparing different façade renovation technologies; and (c) for most renovation options, meeting thermal comfort requirements without mechanical cooling is more problematic than meeting them without heating. In addition, we noted that the tested integrated multi-objective optimization method can be applied to the renovation of other building systems, and the analysis results provide decision makers with the most comprehensive information.

**KEYWORDS:** façade retrofit, house, life cycle assessment

## INTRODUCTION

In Europe, the existing building stock is more than 50 years old, and about 40% of the existing residential buildings were constructed before the 1960s, when building regulations for energy consumption limited [i]. In the United States, majority existing houses were built before the establishment of the Building Energy Codes Program in 1992, by the U.S. Department of Energy (DOE) [ii]. These older buildings represent about 68% of the national residential building stock and are typically energy inefficient due to air leakage and inadequate insulation [2]. The National Renewable Energy Laboratory (NREL) has identified approximately 34.5 million homes with wood stud that have no wall insulation [iii]. Meanwhile, in the United States, the residential remodeling market continues to grow at a fast pace, and around 50% of home renovations involve different façade retrofit strategies. Replacing windows and doors and adding insulation were identified as the most invested energy efficiency retrofit strategies by homeowners [2]. Façade retrofit is defined as an intervention in the building envelope through the addition, replacement, or substitution of new or modernized materials, systems, or components to an existing building [1]. Deep façade retrofit (DFR), when done correctly, can significantly improve the energy performance of a building's thermal envelope and the indoor environment quality [2].

It is important to conduct research at an early design stage of the renovation project, so the research results can serve as an instrument to inform the stakeholders involved, allowing for informative decisions to be made on time [iv]. There are typically multiple stakeholders involved in the renovation project—building owners, contractors, a regulatory agency, designers, and engineers—and they all have different concerns and priorities. Hence, a comprehensive analysis of energy saving, environmental impact reduction, and indoor environmental comfort can potentially facilitate a smooth and optimized process for the renovation project, ultimately satisfying the stakeholders. However, there are limited studies and consensus on the appropriate strategies and technologies for a deep façade retrofit, or façade modernization [v]. Accordingly, this study aims to provide a method to assess different façade deep retrofit strategies, with a focus on life cycle energy saving, life cycle environmental impact potential, and thermal comfort. Seven different strategies were used to test the validity of the method.

## 1.0 MATERIALS AND METHOD

This study balances the environmental impact induced (by the production of insulation and other materials), embodied energy added, and operating energy saved (by an energy demand reduction) through applying seven façade retrofit options to a US reference house located in the state of Maryland. The reference house is derived from the ResStock national database. ResStock was developed by the US National Renewable Energy Laboratory and supported by the U.S. Department of Energy; it combines large public and private data sources, statistical sampling, and detailed

subhourly building simulations and includes more than 350,000 representative buildings primarily made of wood stud frames. To date, it is the largest housing stock data in the United States [vi]. In this database, for the state of Maryland, 16% of houses have a size between 232 m<sup>2</sup> and 325 m<sup>2</sup>, 43% of houses have a size between 139 m<sup>2</sup> and 232 m<sup>2</sup>, 32% of houses have a size smaller than 139 m<sup>2</sup>, and 9% of houses have a size bigger than 325 m<sup>2</sup> (illustrated in figure 1). Furthermore, 50% of existing houses do not have insulation, 7% have R-7 insulation, 29% have R-11 insulation, 8% have R-15 insulation, and 6% have R-19 insulation. The current building code requirement for residential buildings varies from R-13 to R-20; it can be found in Table S.1 in the supplementary documents.

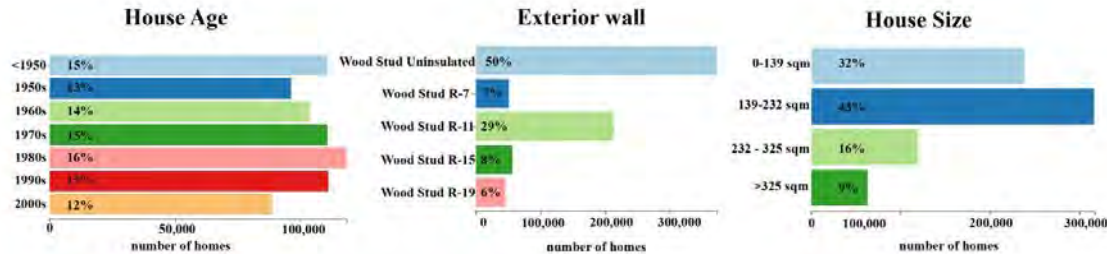


Figure 1: Housing baseline conditions

The reference house used in this study is a one-story single-family detached house of 160 m<sup>2</sup>, 9 m long, 15.6 m wide and 5 m high, mainly oriented in a SW-NE direction, located in a suburban setting in Maryland. Built in 1968, its construction system includes 5.08 x 15.24 cm (2 x 6 in) wood studs and no insulation, a wood siding façade panel, and single-glazed windows. There have been no major renovations, and the house represents the typical condition of residential units in Maryland. Additional details about the reference building can be found in figure 1 in the supplementary document.

### 1.1 Goal and scope of assessment

The primary goal of this case study was to analyze the energy saving and environmental impacts of different building façade retrofit options and compare their impacts to occupants' thermal comfort. The environmental impact assessment included the whole building life cycles defined in the Environmental Product Declarations (EPD EN 15978), A1-D: raw material extraction (A1-A2), manufacturing (A3), on-site construction (A4-A5), maintenance/repair/replacement (B2-B5), demolition and deconstruction (C1-C4), and benefit and load beyond the building life cycle through reuse, recycling, recovery (D). The total assumed building façade life is 65 years. The five impact categories are ozone depletion potential (ODP) in kg CFC-11 eq, global warming potential (GWP) in kg CO<sub>2</sub> eq, smog formation potential (SFP) in kg O<sub>3</sub> eq, acidification potential (AP) in kg SO<sub>2</sub> eq, and eutrophication potential (EP) in kg Neq [vii]. Operating energy includes the energy used during the use phase (B1), measured in megajoule (mj). It includes the energy consumed by the mechanical system, lighting system, plumbing system, water system, security systems, and all other building systems in operation. Embodied energy includes the energy consumed through the life cycle of a building as well as the energy expended for raw material extraction, the manufacturing of materials, and transportation to the construction site; the building construction, maintenance, repair, and replacement of building components during operation; and the demolition, transportation of materials, and their end-of-life management [viii ix].

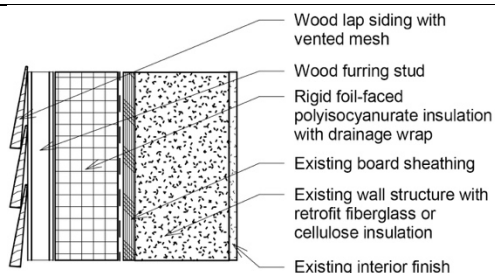
### 2.0 FAÇADE RETROFIT MODEL SETUP

Currently, the most commonly used technique in a building envelope retrofit is the addition of insulation to existing wood stud walls by blowing dense pack fiberglass or cellulose insulation into the cavities between the studs. The benefits of an exterior wall insulation retrofit are twofold. The first benefit is there is minimal disruption to the interior condition, so it is possible for homeowners to remain in the house during the construction. The second benefit is that from the outside, it is possible to provide a continuous air barrier and insulation to prevent heat transfer, without the obstruction of interior studs [x]. Continuous rigid insulation can reduce the possibility of thermal bridging [xi] and leads to a higher insulation value. Adding insulation from the outside is currently achieved by drilling small holes into the existing wall. It is relatively affordable and creates minimal disturbance to the existing occupants since most work can be done from outside. The problem with this method is that adding insulation does not address the thermal bridge and thermal leakage [xii], hence reducing the effectiveness of energy saving. Even after completion, the drill-and-fill wall system is still under-insulated according to current building energy standards (R13-19 for residential buildings) and only achieves an R-value of around R-10 [xiii]. In order to mitigate the problems, other deep façade renovation options without thermal leakage have been extensively studied by research institutions and industry partners. The Pacific Northwest National Laboratory, Oak Ridge National Laboratory, and the University of Minnesota are conducting a three-year, joint study of residential retrofit wall assemblies funded by the Department of Energy. The team identified seven exterior wall retrofit strategies for wood stud houses; the assembly make-up can be found in in table 1 [2]:



**RE1: R value (hr/ft<sup>2</sup>.°F/Btu) = 30**

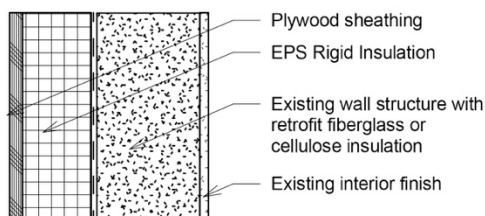
Layers	Materials	Dimension (cm)
External layer	Wood lap siding with vented mesh	3.8
Layer 2	Wood furring stud	2.54 x 7.62 (1x3 inch)
Layer 3	Rigid foil-faced polyisocyanurate insulation with drainage wrap (as air barrier)	10.16 (4 inch)
Layer 4	Existing board sheathing	
Layer 5	Existing wall structure with retrofit fiberglass or cellulose insulation	15.24 (6 inch)
Internal layer	Existing interior finish	Varies



RE 1

**RE2: R value (hr/ft<sup>2</sup>.°F/Btu) = 25.7**

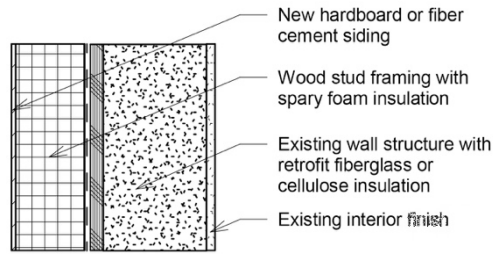
External layer	Plywood sheathing	
Layer 2	Rigid un-faced expanded polystyrene board (EPS)	3.2 (1.25inch)
Layer 3	Existing wall structure with retrofit fiberglass or cellulose insulation	15.24 (6 inch)
Internal layer	Existing interior finish	Varies



RE 2

**RE3: R value (hr/ft<sup>2</sup>.°F/Btu) = 25** Spray foam retrofit

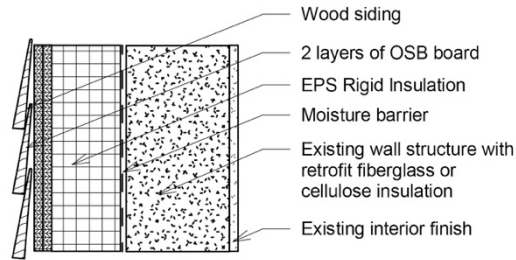
External layer	New hardboard or fiber cement siding	1.27
Layer 2	Wood stud framing with Spray foam insulation	5.08 x 10.16 (2x4 inch)
Layer 3	Existing wall structure with retrofit fiberglass or cellulose insulation	15.24 (6 inch)
Internal layer	Existing interior finish	Varies



RE 3

**RE4: R value (hr/ft<sup>2</sup>.°F/Btu) = 18** Retrofit Insulated Panel (RIP)

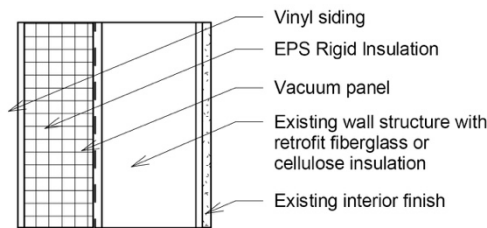
External layer	Wood lap siding with drainage wrap (as air barrier)	3.8
Layer 2 (RIP panel)	2 layers of OSB board	2.54
Layer 3	EPS Rigid insulation	10.16 (4 inch)
Layer 4	Existing wall structure with retrofit fiberglass or cellulose insulation	15.24 (6 inch)
Internal layer	Existing interior finish	Varies



RE 4

**RE5: R value (hr/ft<sup>2</sup>.°F/Btu) = 10** Vacuum Insulated Siding Panel

External layer	Vinyl siding	1 cm (0.5 inch).
Layer 2	Rigid foam insulation	2.54 cm (1 inch).
Layer 3	Vacuum panel	40 x 60 (16x24 inch)
Layer 4	Existing wall structure	15.24 (6 inch)
Internal layer	Existing interior finish	Varies



RE 5

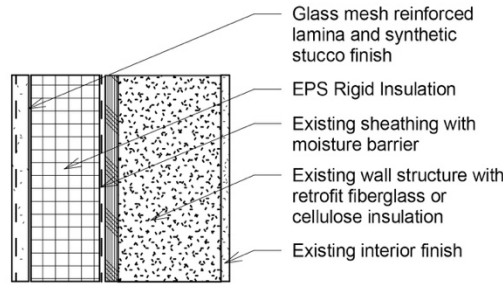
**RE6: R value (hr/ft<sup>2</sup>.°F/Btu) = 19** Exterior insulation and finish systems (EIFSs)

External layer	Glass mesh reinforced lamina and synthetic stucco finish	2.54 cm (1 inch)
Layer 2	EPS Rigid insulation	7.42 – 15.24 (3-6 inch)
Layer 3	Existing sheathing with moisture barrier	2.54 cm (1 inch).
Layer 5	Existing wall structure with retrofit fiberglass or cellulose insulation	15.24 (6 inch)

Internal layer

Existing interior finish

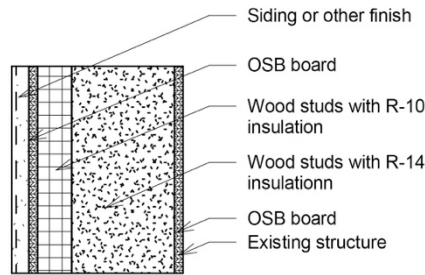
Varies



RE 6

RE7: R value (hr/ft<sup>2</sup>.°F/Btu) = 25 EnergiesProng prefabricated panels

External layer	Siding or other finish	Varies
Layer 2	OSB board	0.95 cm (3/8 inch) OSB
Layer 3	Wood studs with R-10 insulation in cavities	5.08 x 5.08 cm (2x2 inch)
Layer 4	Vertical wood studs with R-14 insulation in cavities	5.08 x 10.16 cm (2x4 inches)
Layer 6	OSB board	0.95 cm (3/8 inch) OSB
Layer 7	Existing wall structure	Varies



RE 7

### 3.0 RESULTS

#### 3.1 Overall results of energy saving

##### 3.1.1 Operating energy reduction

Regarding potential operational energy saving, compared to existing buildings, the operating energy saving ranges from 41.3% to 46.8%. Figure 3 shows RE1 as having the highest saving potential and RE5 having the lowest. Carbon emissions reduction is related to operating energy saving; therefore, it follows the same trend. The operating saving is directly related to the added R-value in the façade.

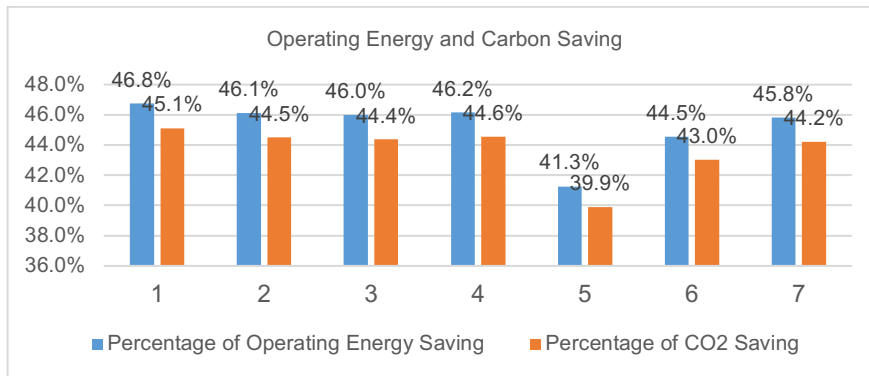
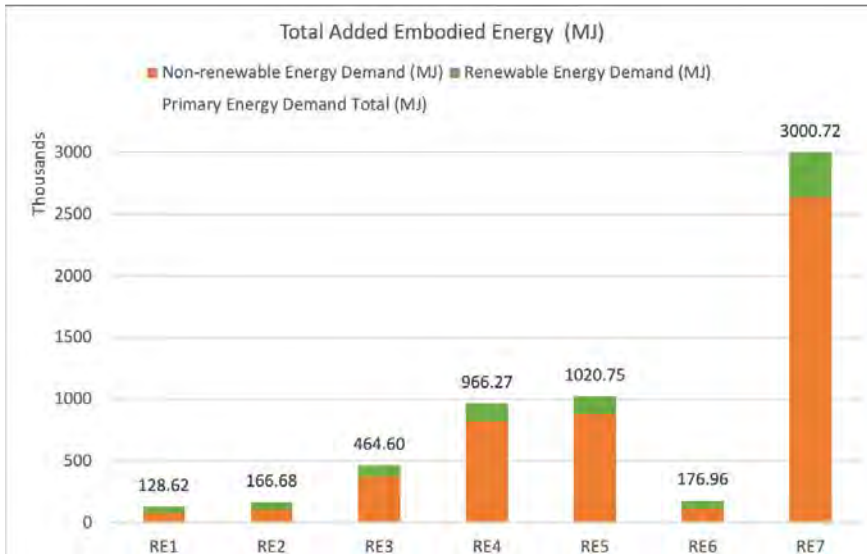


Figure 3: Operating energy and carbon saving

### 3.1.2 Embodied energy increase

Figure 4 shows the embodied energy results by the MasterFormat division of the Construction Specifications Institute (CSI). Among all options, RE7 has the highest embodied energy increase, with 88% being from non-renewable sources, whereas RE1 has the lowest embodied energy increase, with only 62% being from non-renewable sources. In RE7, Division 6, Wood/Plastics/Composites (Div 6), materials contribute to 98% of the embodied energy, and in RE1, Wood/Plastics/Composites, materials contribute to 54% of embodied energy (refer to table S2 in supplementary material for detailed analysis results).



**Figure 4:** Embodied energy added

The observation of an increase of embodied energy from different life stages of a building allowed for two patterns to emerge. In RE4, RE5, and RE7, during the entire building's life span, maintenance and replacement (B2-B5) contributes the most added embodied energy: about 64%, for RE1, RE2, RE3, and RE6, with the biggest contributor to an embodied energy increase being the product stage (A1-A3), 55%-77% (refer to table S3 in the supplementary material). The commonality among RE4, RE5, and RE7 is that they are prefabricated panels made off-site. Manufacturing façade panels in a factory allows for better management of the resources and the waste stream, with more efficient use of materials, more careful storage, and the possibility of design to suit standard sizes. In addition, any waste that occurs can be easily collected and reused or recycled. Many off-site manufacturing plants have recycling facilities installed, as this reduces the costs of disposal of waste [xiv]. Therefore, during the product stage, prefabricated panels demand less embodied energy. However, one of the perceived problems of prefabricated façade panels is their quality and potential needs for repair and maintenance. At present it is unclear how durable the new types of prefabricated panels are. There are three common quality problems in prefabricated panels: First, the insulation layer can easily break [xv], and cracks often occur during the transportation and lifting process of laminated plates, which will shorten the life span of the panel [34]. Second, if the quality of the sandwich panel is poor, it can cause high thermal conductivity and moisture leakage [xvi], and moisture and condensation can reduce the panel's service life. Third there may be connection problems between the panels. All together, these problems can reduce a prefabricated panel's life span, hence increasing the frequency of replacement and repair. Also, when a prefabricated panel needs to be repaired, normally, the entire panel must be replaced, unlike the on-site constructed façade system where only the portion damaged requires replacement. This can explain why RE4, RE5, and RE7 have the highest embodied energy increase for maintenance and replacement, while the rest of the renovation options have different results.

### 3.2 Overall Environmental Performance Analysis

Three general findings can be concluded from figure 5. First, the quantity of materials (mass) is correlated with the environmental impact categories GWP, AP, and EP, but not ODP. The next sections will take a closer look at each impact category to identify the major contributors. Second, RE 7 is the option with the highest environmental impact in three categories: AP, EP, and GWP; RE3 performed the worst in the ODP category. Among the other renovation options, RE1 and RE2 seem to be optimized options that can be considered for future development; however, RE5 performed the worst across all categories (RE 5 also performed the worst in operating energy saving). Third, the impact to ODP from façade renovation should be examined separately to understand why its trend and outcome differ greatly from the rest of the environmental categories.

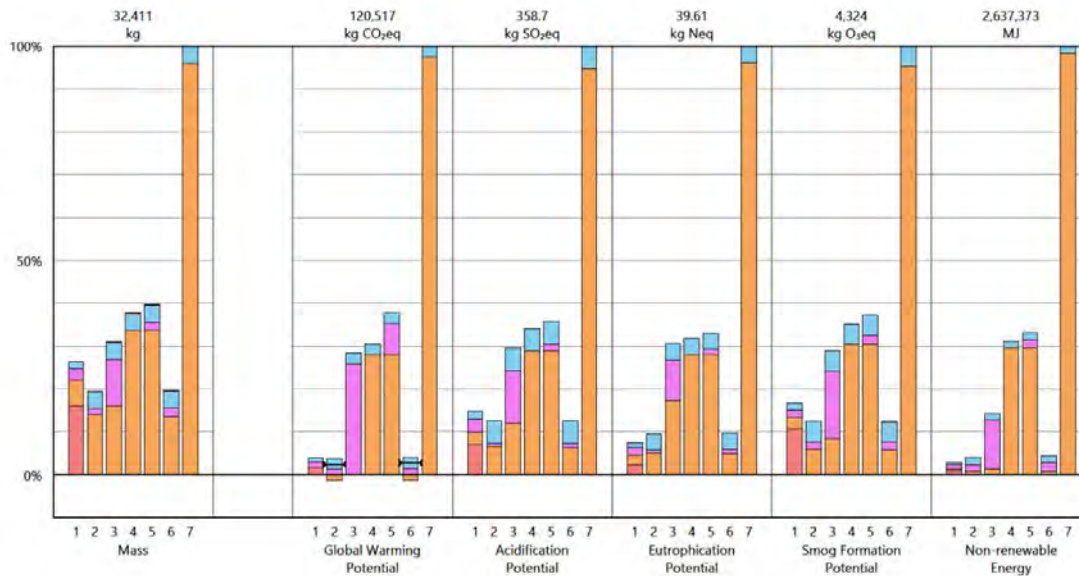


Figure 5: Façade renovation options: environmental performance comparison

### 3.3 Environmental impact summary

Overall, Div6, Wood/Plastic/Composite products are the main contributor to acidification potential and eutrophication potential. Alternative sustainable products should be studied and further developed since there are currently no other options. The primary contributor to ozone depletion potential is stainless hardware and aluminum, which jointly contribute more than half of the ozone depletion potential from façade renovation. These two materials are the most commonly used materials, particularly for window frames and façade connectors. Global warming potential is the most complicated environmental impact category, and its performance is influenced by all types of building materials and components. There is no single building material, division, or material that can be identified as a main contributor. This suggests that in order to reduce GWP, a holistic approach needs to be implemented, with attention given to all the building façade assemblies instead of the individual layers or components.

### 3.4 Thermal Comfort

The assessment of thermal comfort is based on only ventilation without mechanical cooling and heating. Maryland is located in climate zone 4: mixed-humid (1500 < CDD10°C < 3500, 2000 < HDD18°C ≤ 3000). Without a mechanical system, none of the renovation options completely meet the thermal comfort standard based on ASHRAE 55. Figure 6 shows that a higher thermal property in the façade does not directly lead to better thermal comfort. Instead, RE2, with the second highest insulation value, leads to better thermal comfort, meeting the requirement 65% of the time. During the other 35%, RE2 does not meet the thermal comfort requirement, with 26% of the occupied hours being too hot and 9% of the hours too cold. For most renovation options, attempting to meet the thermal comfort requirements without mechanical cooling is more problematic than trying to meet the requirements without heating in the wintertime.

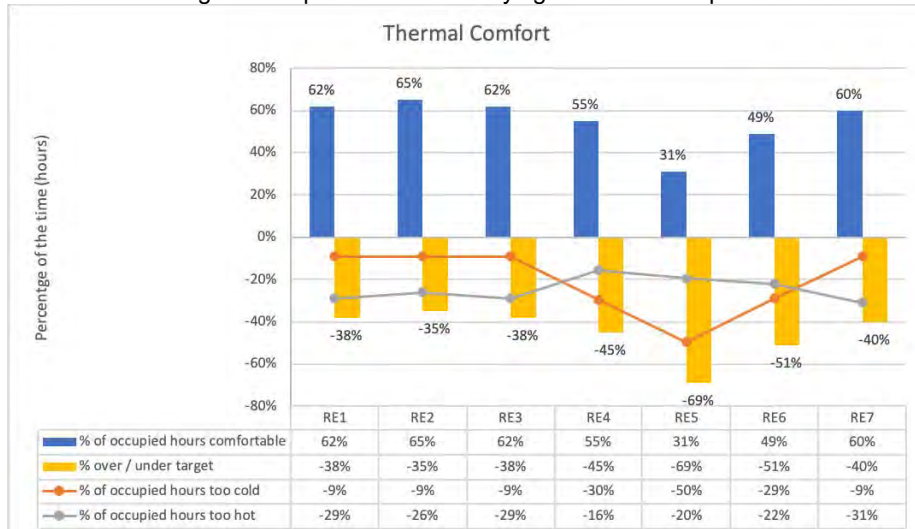


Figure 6: Thermal comfort comparison

## CONCLUSION

This study provides a basis for further research on façade renovation technologies in the residential sector. Seven different façade renovation options are analyzed with the goal of an overall carbon emissions reduction. The main conclusions are listed below:

- In comparing the life cycle energy saving and environmental impact reduction, it is clear that insulation types, quantity, and quality have a significant impact on global warming potential and other environmental categories. Different insulation types have impact on different environment categories.
- The common perception of creating super-insulated houses to reduce energy use and environmental impact has been proven incorrect, which aligns with some previous studies of houses in Denmark [36], Canada [xvii], and Madrid [xviii]. The life cycle approach highlights the fact that energy saving alone is not sufficient when comparing different façade renovation technologies.
- The consequential environmental impact analysis demonstrates that even some façade renovation options do not result in the highest life cycle energy saving. However, when considering various environmental impacts, including global warming potential, those options can be chosen as an optimized solution because they prevent a wide range of environmental impacts, such as ozone depletion and acidification.

## REFERENCES

- 1 Zuhaib124, S., Hajdukiewicz124, M., Keane124, M., & Goggins1234, J. (2016). Facade modernisation for retrofitting existing buildings to achieve nearly zero energy buildings.
- 2 Antonopoulos, C. A., Metzger, C. E., Zhang, J., Ganguli, S., Baechler, M. C., Nagda, H., & Desjarlais, A. (2019). Wall Upgrades for Residential Deep Energy Retrofits: A Literature Review (No. PNNL-28690). Pacific Northwest National Lab.(PNNL), Richland, WA (United States).
- 3 Wilson, E. J., Harris, C. B., Robertson, J. J., & Agan, J. (2019). Evaluating energy efficiency potential in low-income households: A flexible and granular approach. *Energy policy*, 129, 710-737.
- 4 Staljanssens, J., Mangé, S., Van Den Bossche, N., & Moens, J. (2015). Facade retrofit strategies. Case study of the building complex K12 of the university hospital Ghent. *Energy Procedia*, 78, 961-966.
- 5 Martinez, A., Patterson, M., Carlson, A., & Noble, D. (2015). Fundamentals in façade retrofit practice. *Procedia engineering*, 118, 934-941.
- 6 National Renewable Energy lab. "ResStock National Baseline (EFS v2)." Accessed June 8, 2020. [https://resstock.nrel.gov/dataviewer/efs\\_v2\\_base](https://resstock.nrel.gov/dataviewer/efs_v2_base)
- 7 USGBC, LEED V4 for building design and construction, US Green Building Council, Washington, DC, 2014
- 8 Chastas, P., Theodosiou, T., & Bikas, D. (2016). Embodied energy in residential buildings-towards the nearly zero energy building: A literature review. *Building and Environment*, 105, 267-282.
- 9 Hu, M. (2020). The Embodied Impact of Existing Building Stock. In *Examining the Environmental Impacts of Materials and Buildings* (pp. 1-31). IGI Global.
- 10 Lstiburek, J. W. (2007). The perfect wall. *Ashrae Journal*, 49(5), 74.
- 11 Jackson, R. K., Kim, E. J., Roberts, S., & Stephenson, R. (2012). *Advancing Residential Retrofits in Atlanta*. ORNL-TM488. Oak Ridge, TN.: Oak Ridge National Laboratory.
- 12 Theodosiou, T. G., Tsikaloudaki, A. G., Kontoleon, K. J., & Bikas, D. K. (2015). Thermal bridging analysis on cladding systems for building facades. *Energy and Buildings*, 109, 377-384.
- 13 Desjarlais, A., Biswas, K., & Smith, D. Seeking Solutions to Cost-Effectively Insulate an Existing Wall Assembly. Assessed May 26,2020. <https://iibec.org/wp-content/uploads/2019-cts-desjarlais.pdf>
- 14 Gorgolewski, M.T. "Prefabrication and sustainability in UK housing. Accessed June 9, 2020. [https://web.ornl.gov/sci/buildings/conf-archive/2004%20B9%20papers/174\\_Gorgolewski.pdf](https://web.ornl.gov/sci/buildings/conf-archive/2004%20B9%20papers/174_Gorgolewski.pdf)
- 15 Sun, J. (2019). The Common Quality Problems and Preventive Measures of Prefabricated Building Construction.
- 16 Knyziak, P., Krentowski, J. R., & Bieranowski, P. (2017). Risks of the durability of large-panel buildings elevations in reference to the conclusions from technical conditions audits. In *MATEC Web of Conferences* (Vol. 117, p. 00080). EDP Sciences.
- 17 Pedinotti-Castelle, M., Astudillo, M. F., Pineau, P. O., & Amor, B. (2019). Is the environmental opportunity of retrofitting the residential sector worth the life cycle cost? A consequential assessment of a typical house in Quebec. *Renewable and Sustainable Energy Reviews*, 101, 428-439.
- 18 Pajek, L., Hudobivnik, B., Kunič, R., & Košir, M. (2017). Improving thermal response of lightweight timber building envelopes during cooling season in three European locations. *Journal of Cleaner Production*, 156, 939-952.



## ENDNOTES

- i Zuhaib124, S., Hajdukiewicz124, M., & Goggins1234, J. (2016). Facade modernisation for retrofitting existing buildings to achieve nearly zero energy buildings.
- ii Antonopoulos, C. A., Metzger, C. E., Zhang, J., Ganguli, S., Baechler, M. C., Nagda, H., & Desjarlais, A. (2019). Wall Upgrades for Residential Deep Energy Retrofits: A Literature Review (No. PNNL-28690). Pacific Northwest National Lab.(PNNL), Richland, WA (United States).
- iii Wilson, E. J., Harris, C. B., Robertson, J. J., & Agan, J. (2019). Evaluating energy efficiency potential in low-income households: A flexible and granular approach. *Energy policy*, 129, 710-737.
- iv Staljanssens, J., Mangé, S., Van Den Bossche, N., & Moens, J. (2015). Facade retrofit strategies. Case study of the building complex K12 of the university hospital Ghent. *Energy Procedia*, 78, 961-966.
- v Martinez, A., Patterson, M., Carlson, A., & Noble, D. (2015). Fundamentals in façade retrofit practice. *Procedia engineering*, 118, 934-941.
- vi National Renewable Energy lab. "ResStock National Baseline (EFS v2)." Accessed June 8, 2020. [https://resstock.nrel.gov/dataviewer/efs\\_v2\\_base](https://resstock.nrel.gov/dataviewer/efs_v2_base)
- vii USGBC, LEED V4 for building design and construction, US Green Building Council, Washington, DC, 2014
- viii Chastas, P., Theodosiou, T., & Bikas, D. (2016). Embodied energy in residential buildings-towards the nearly zero energy building: A literature review. *Building and Environment*, 105, 267-282.
- ix Hu, M. (2020). The Embodied Impact of Existing Building Stock. In *Examining the Environmental Impacts of Materials and Buildings* (pp. 1-31). IGI Global.
- x Lstiburek, J. W. (2007). The perfect wall. *Ashrae Journal*, 49(5), 74.
- xi Jackson, R. K., Kim, E. J., Roberts, S., & Stephenson, R. (2012). *Advancing Residential Retrofits in Atlanta*. ORNL-TM488. Oak Ridge, TN.: Oak Ridge National Laboratory.
- xii Theodosiou, T. G., Tsikaloudaki, A. G., Kontoleon, K. J., & Bikas, D. K. (2015). Thermal bridging analysis on cladding systems for building facades. *Energy and Buildings*, 109, 377-384.
- xiii Desjarlais, A., Biswas, K., & Smith, D. Seeking Solutions to Cost-Effectively Insulate an Existing Wall Assembly. Assessed May 26, 2020. <https://iibec.org/wp-content/uploads/2019-cts-desjarlais.pdf>
- xiv Gorgolewski, M.T. "Prefabrication and sustainability in UK housing. Accessed June 9, 2020. [https://web.ornl.gov/sci/buildings/conf-archive/2004%20B9%20papers/174\\_Gorgolewski.pdf](https://web.ornl.gov/sci/buildings/conf-archive/2004%20B9%20papers/174_Gorgolewski.pdf)
- xv Sun, J. (2019). The Common Quality Problems and Preventive Measures of Prefabricated Building Construction.
- xvi Knyziak, P., Krentowski, J. R., & Bieranowski, P. (2017). Risks of the durability of large-panel buildings elevations in reference to the conclusions from technical conditions audits. In *MATEC Web of Conferences* (Vol. 117, p. 00080). EDP Sciences.
- xvii Pedinotti-Castelle, M., Astudillo, M. F., Pineau, P. O., & Amor, B. (2019). Is the environmental opportunity of retrofitting the residential sector worth the life cycle cost? A consequential assessment of a typical house in Quebec. *Renewable and Sustainable Energy Reviews*, 101, 428-439.
- xviii Pajek, L., Hudobivnik, B., Kunič, R., & Košir, M. (2017). Improving thermal response of lightweight timber building envelopes during cooling season in three European locations. *Journal of Cleaner Production*, 156, 939-952.



# Performative Environments of Alliesthesia: Thermal Perception in Solar Screened Offices Under Different Sky Conditions

Niyati Naik<sup>1</sup>, Ihab Elzeyadi<sup>2</sup>, Virginia Cartwright<sup>3</sup>

<sup>1,2,3</sup> University of Oregon, Eugene, OR

**ABSTRACT:** Through this work, the researchers explored occupant's thermal perception inside thermally nonuniform, indoor environments of solar screened perimeter office spaces. They examined the potential of static-fixed and dynamic-movable solar screens with geometric patterns to influence the subjective thermal perception of comfort and pleasure inside single-occupancy office set-ups. The investigation comprised of a within-subject experimental design that exposed 15 participants under sunny and 12 others under overcast sky conditions of an east-facing, static and dynamic screened, single occupancy experimental office space set-ups during the summer months in moderate climate of ASHRAE, CZ 4C. Every participant, who was exposed for an hour, carried out office-like tasks and responded to questionnaires on the thermal perception of the indoor environment. Besides the subjective responses, the indoor environmental thermal and visual data of the set-ups were recorded during the experimental period. Subjective data on thermal perception was correlated with indoor environmental data to understand the inconsistencies between predicted and actual thermal comfort, and to identify the thermal and visual parameters influencing thermal pleasure under different sky conditions. It was found that the thermal comfort PMV model over-predicted discomfort in the solar screened building perimeter spaces. Dynamic screens under sunny sky conditions could evoke the highest magnitude of thermal pleasure when the indoor environmental parameters indicated a move from predicted discomfort to comfort. Mean radiant temperature, relative humidity, and horizontal illuminance significantly impacted thermal pleasure perception. Moving beyond the usual practice of making architecture for visual delight, through this work the researchers followed a design approach that employed architecture to offer pleasurable thermal experiences for occupant satisfaction and well-being.

**KEYWORDS:** Solar screens, Perimeter Offices, Thermal Comfort, Thermal Pleasure, Alliesthesia

## INTRODUCTION: INDOOR ENVIRONMENTS FOR OCCUPANT PLEASURE

Buildings' standards and design guidelines prescribed indoor environments are designed to be static, uniform, or neutral; with occupants detached from nature to create "experiential monotony" (Brager et al., 2015; Brager, 2019). Conventional building standards aimed at "reducing the negative" aspects of the indoor environments to provide comfort, deprives occupants of sensory experiences and climate changes. In times, when design decisions are driven by standards, architects and building designers should respond by "enhancing the positives" of the indoor environments by not only making them comfortable but also healthy, engaging, and delightful. These qualities impact the sense of pride in occupants and positively enhance their performance (Elzeyadi, 2009). In designing sensory experiences, the highest goal should be of creating environments that support occupants' "physical, emotional, and social health, and their cognitive function and productivity" (Brager, 2019).

The available thermal comfort standards accept narrow limits of thermal conditions or uniform environments as 'comfortable' (ASHRAE Standard-55; EN15251; ISO 7730). It has been reported, however, that non-uniform thermal conditions like systematic exposures to mild temperature excursions outside the comfort limit may increase occupant acceptance of a wider temperature range (Van Marken Lichtenbelt et al., 2017). This has the potential to impact occupant resilience and adaptability to their surrounding; thus, positively influencing long term health (Brager 2015). Such mildly high or low temperatures in a non-uniform thermal environment may be perceived as pleasurable and could garner higher occupant satisfaction (Brager, 2015; de Dear, 2012). The annual daylighting metrics (IESNA, LM-83, 2012) define thresholds for standardizing daylighting sufficiency and excessiveness respectively; in building indoor spaces. Direct sunlight indicated by horizontal illuminance exceeding 1000 lux; at a point is not allowed for more than 250 hours a year for more than 10% of space. While this step limits solar penetration to prevent visual discomfort inside buildings, occupants generally welcome it. Hence, preventing it would promote "dull spaces" (Reinhardt, 2015; Boubekri et al., 1991). Moreover, sunlight and associated higher illuminance levels impact occupants' emotional well-being, reduces psychological distress, and treats seasonal affective disorder (Golden et.al, 2005; Partonen & Lonnqvist, 2000; Abboushi et. al, 2019).

The field of biophilic design is based on the central idea that aims at providing a higher level of “experiential delight” or pleasure to occupants. The literature on biophilic design offers evidence about its impact on sensory pleasure (Ryan & Browning, 2020). Human perception of thermal pleasure under exposure to indoor thermal environmental variability has its physiological basis in the concept of alliesthesia (Parkinson & deDear, 2015). Alliesthesia also explains the physiological basis for delight perceived by other types of sensory experiences (Cabanac, 1971). For this study, the authors explored thermal alliesthesia and resulting thermal pleasure in building perimeter offices shaded by perforated solar screen window shading. The solar screen designs were inspired by biophilic vernacular solar screens.

## 1.0 SOLAR SCREEN SHADING AND THERMAL PERCEPTION

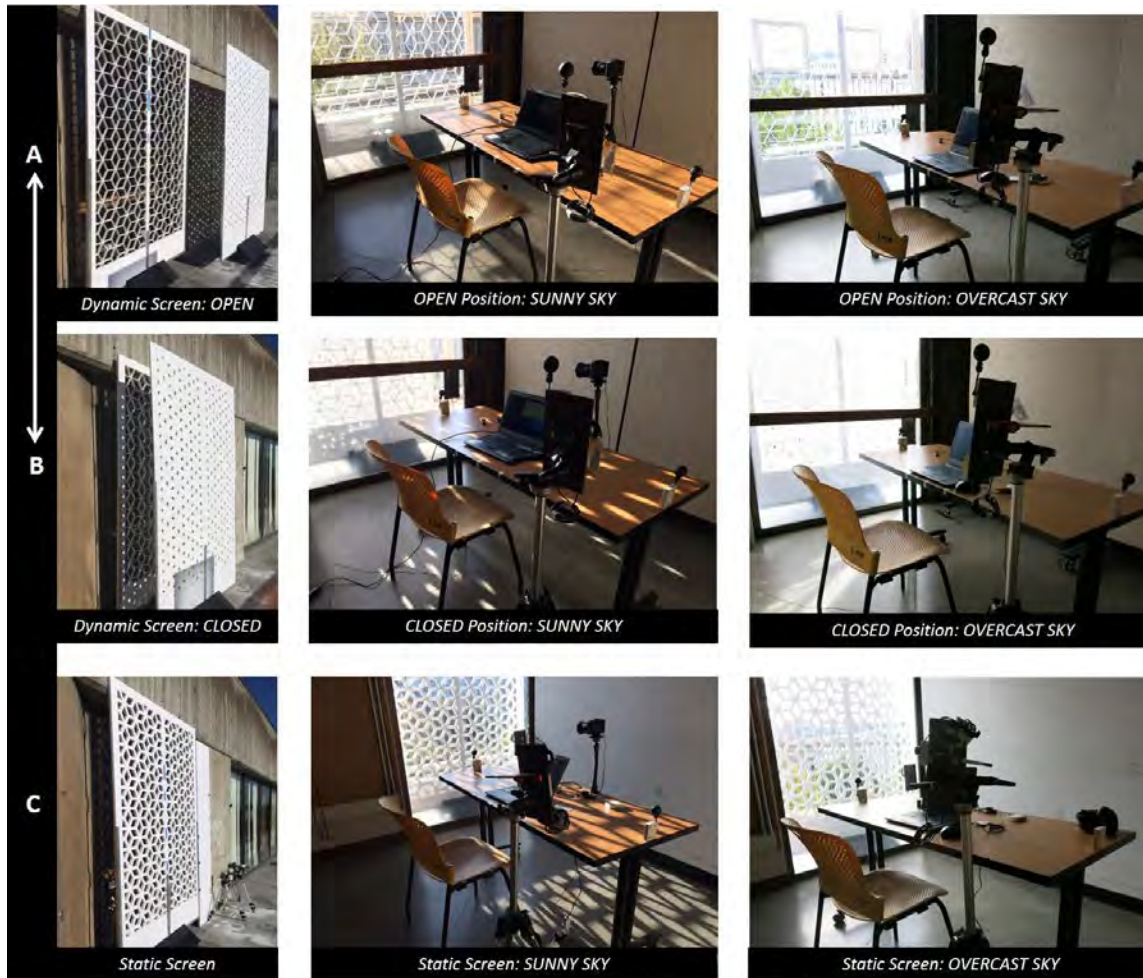
Solar screens with geometrically patterned perforations typical of vernacular buildings in the Middle East, have a strong architectural significance. It is a continuing trend of borrowing those patterns in contemporary façade shading in static/fixed and dynamic/movable modes of operation. The geometric properties like; patterns, perforation ratios (PR = % of opening), depth ratios (DR = hole depth/hole width), and panel thickness; of static screens are optimized to respond to extreme solar conditions in a climatic setting. Whereas those dynamic screens can be changed to respond to outdoor environmental changes and/or occupant demands in a climatic setting.

Vernacular solar screens constructed out of stone, masonry, or wood are massive structures. In distinction contemporary screens are lightweight structures that are manufactured using composite materials. Contemporary screens with 70 to 90% PR and DR within 0.5 to 1 were found to achieve optimum daylighting and cooling energy savings compared to non-shaded conditions (Sabry et.al, 2014; Sherif et al., 2012). But the recommended geometric parameters resulted into a light-weight façade with large and deep openings that did not perform very well at managing glare (Lai et.al, 2017; Chi et.al, 2017; Emami and Giles, 2016). Higher distribution of smaller perforation openings in 1” (3 cm) to 3” (8 cm) thick panels increased diffused daylight and reduced glare (Emami and Giles, 2016). For hot-dry, hot-arid, and hot-humid climates, screens with 30 to 50 % PR and 1” (3 cm) to 3” (8 cm) panel thicknesses were recommended for achieving thermal comfort (Alawadhi, 2018; Chi et.al, 2017; Elzeyadi & Batool, 2017; Gandhi et al., 2014). Further, screen geometric patterns formed by rhombus as a basic shape offered better daylighting performance compared to square, triangular, circular, hexagonal, or octagonal shapes (Oghazian & Mahdavinejad, 2017). While the application of contemporary solar screens is continuously being researched for tropical climates; their presence prevails on buildings in other climate types (Naik & Elzeyadi, 2020b). For moderate climate types, it was identified that their application could increase occupant comfort hours by 9-13% (Elzeyadi et al., 2016).

As shown in Figure 1, the researchers tested the performance of two types of solar screens in the summer months of the moderate climate of ASHRAE Climate Zone 4C. Of those two types, one was a static screen; the geometric parameters of which were optimized for extreme summer conditions. The other was a dynamic screen, which was designed to switch between OPEN and CLOSED positions, which brought changes in the screen geometric parameters that were higher and lower than its optimized values. The design and fabrication of the prototypes were informed by a sensitivity study of different combinations of their geometric parameters on predicted thermal performance in a computational environment (Naik & Elzeyadi, 2020b). The screened set-ups were arranged as single-occupancy offices that were physically isolated inside an east-facing, open plan studio at Lawrence Hall, University of Oregon. Volunteers participating in the experiment reported their thermal perception at regular intervals during their exposure period. In this work, the researchers reported the impact of the two screen prototypes on the indoor thermal-visual environment and corresponding human thermal perception inside single occupancy perimeter spaces. Trends between indoor thermal and visual environment and subjective thermal perception of pleasure were compared and correlated.

## 2.0 EXPERIMENTAL SET-UP AND DATA COLLECTION

Experiments involving human participants inside the solar screened set-ups were carried out between 8:00 AM to 10:30 AM in the months of August-September in Eugene, Oregon (ASHRAE CZ 4c). An equal number of male and female participants within an age group of 21-50 years participated. As shown in Figure 2 (A), the experimental design led to the exposure of 15 participants under sunny and 12 under overcast sky conditions to the east-facing static and dynamic screened set-ups. The total participation time for each person’s exposure was 1.5 hours, which required one to arrive thirty minutes before the 1-hour screened exposure. In these initial thirty minutes of pre-exposure, participants were made to occupy a thermally comfortable conditioned space and were familiarized with the type of questionnaires and tasks to respond to during the screened exposure. The program of their 1-hour screened exposure is illustrated in Figure 2(B). It shows the time intervals when the participants responded to thermal perception questionnaires and did assigned tasks. Moreover, the time intervals at which the dynamic screen changed from OPEN and CLOSED positions is also highlighted.



**Figure 1:** Single occupancy set-ups shaded by static and dynamic solar screens under different sky conditions. Dynamic screen prototype was operable and transited between OPEN and CLOSED positions; A-B. Static screen, C, was fixed.

## 2.1 Subjective and Indoor Environmental Data Collection

Participants' responses were recorded in an automated and timed, online-based survey. The response-seeking items consisted of a thermal questionnaire (Q1), a general environmental questionnaire (Q2), and an office-like performance task sequence. Q1 sought participant responses on their thermal perception (pleasure, sensation, comfort, preference, and local body sensation) within five minutes of the screen's opening or closing (Figure 2B). While investigating the participants' thermal perception using the questionnaire Q1, the key questions posed using seven-point, standardized, and categorial Likert scales were how pleasant or unpleasant they felt, how cold or hot they felt, how cold or hot they felt at local body parts on its left and right sides, what type of thermal condition was preferred by them at that moment, and what was their perception on thermal comfort at that moment? The question on thermal pleasure was asked thrice; at the beginning, middle, and end during the five minutes of Q1. The general questionnaire Q2 appeared in the final 10-minutes of the exposure. All the performance tasks were of medium-level difficulty. The details of those tasks and analysis of participants' performance on them are not within the scope of this paper.

Indoor thermal and visual data were also logged every minute during every participant's 1-hour screened exposure. The screened set-ups had pre-programmed data loggers to measure air temperatures, relative humidity, globe temperatures, vertical, and horizontal illuminance. Data-loggers to measure the thermal environment were placed as per ASHRAE-55 specifications for conditions involving seated occupants. Details on indoor thermal environmental thermal sensing equipment and its placement in the set-ups have been described in (Naik & Elzeyadi, 2020c). The measured indoor environmental thermal data and each participant's data related to their clothing and metabolic rate were used to compute the Predicted Mean Vote (PMV) values for each minute of a person's screened exposure. Fanger's PMV model built-in as a function in R package 'comf' was used to calculate the PMV values (Fanger, 1970; Schweiker, 2016). The preprogrammed data logging units to measure horizontal and vertical illuminance (lux/foot-candles) consisted of a calibrated photometer sensor (LI-COR LI-210R) connected to a calibrated transconductance amplifier (UTA for LCORTM sensors) and a data logger (Onset-HOBO U-12).

The logged output was converted to Lux, using Eq. (1):

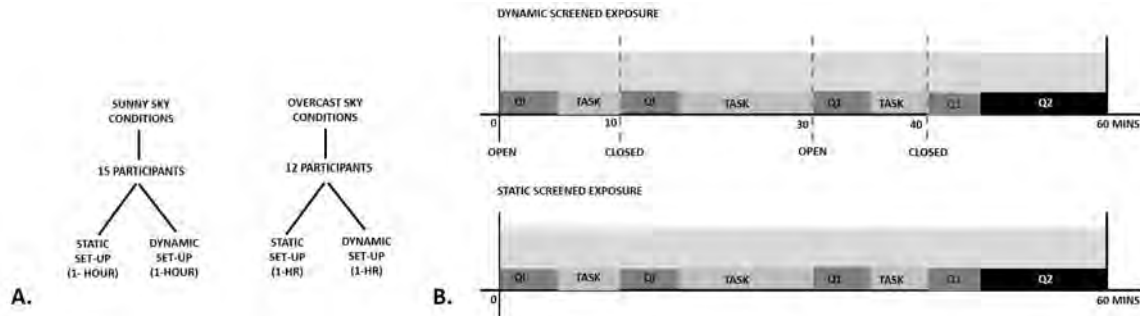
$$\text{Light level (Lux)} = V \times [K1 / K2] \times 1000 \quad (1)$$

Where,

V= HOBO output (volts)

K1 = 3.13 (klux per  $\mu\text{Amp}$ ) is the calibration multiplier from LI-210R (hypothetical, sensor dependent) and

K2 =0.056 (volts per  $\mu\text{Amp}$ ) HOBO gain based on 2.5 volts full-scale output at 41.667  $\mu\text{Amp}$  input



**Figure 2:** (A) Design of experiments involving human participants. (B) Program of 1-hour exposure to static and dynamic screened set-ups

### 3.0 DATA ANALYSIS AND FINDINGS

The findings reported in this paper are focused on; (i) highlighting the difference between predicted and actual thermal comfort (Figure 3), (ii) noting participants' thermal pleasure response and understanding its relationship with their thermal sensation (Figure 4), (iii) observing the change in the visual environment and its relationship with thermal pleasure, and (Figure 5) (iv) quantifying relationships of thermal and visual environmental variables with subjective reporting of thermal pleasure (Figure 6).

The PMV values between (1) and (-1) predict occupant thermal sensation between slightly warm and slightly cool, indicating the indoor thermal conditions to be comfortable. As shown in Figure 3, PMV trends for static and dynamic set-ups under sunny sky conditions, predicted the thermal environment of the set-ups as thermally discomforting, towards the warmer side (Figure 3 - A,B). Whereas the actual subjective thermal sensation was reported to be transiting between slightly warm and slight cool, within the comfort zone. The PMV trends for static and dynamic screened set-ups under overcast sky conditions predicted the indoor thermal environment to be between slightly warm and neutral (Figure 3- B,C). But the participants sensed these thermal environmental conditions between neutral and slightly cool. This visual analysis reinforces the observations in previous studies that the predicted mean vote (PMV) metric over-predicts an occupant's thermal discomfort.

A participant's reporting of thermal pleasure was dependent upon (i) his/her base case thermal sensation and (ii) change in his/her thermal sensation from that of the base case feeling (Figure 4). For the dynamic screened set-up under sunny sky conditions, the base case thermal condition was sensed to be slightly warm (Figure 4 - A). When the screen CLOSED from OPEN position, participants sensed the change in the indoor thermal environment from slightly warm to slightly cool, which is when they reported thermal pleasure. Similarly, for dynamic set-up under overcast sky conditions (Figure 4 - C) and static set-up under sunny sky conditions (Figure 4 - D), the base case thermal environment was sensed as slightly cool. A higher magnitude of thermal pleasure was reported when transition in the indoor environment was sensed from slightly cool towards neutral when the screen changed to OPEN from a CLOSED position(Figure 4- C).



TECHNOLOGICAL PERFORMANCES  
Thermal Perception, Boundaries and Comfort Assessment

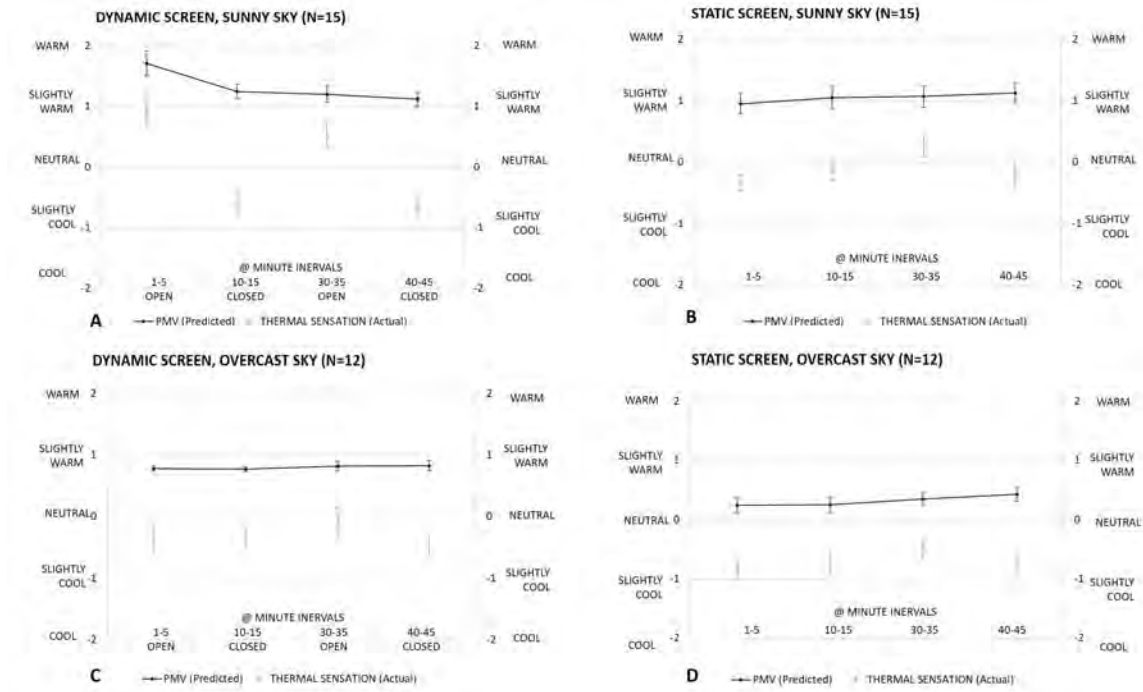


Figure 3: Difference between predicted and actual thermal sensation

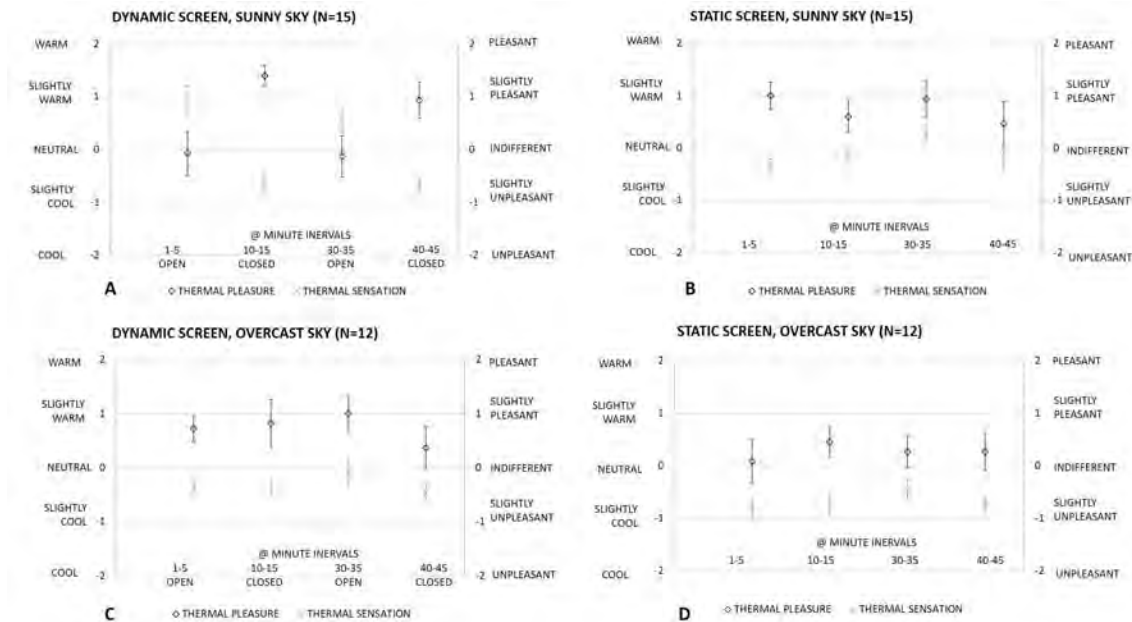
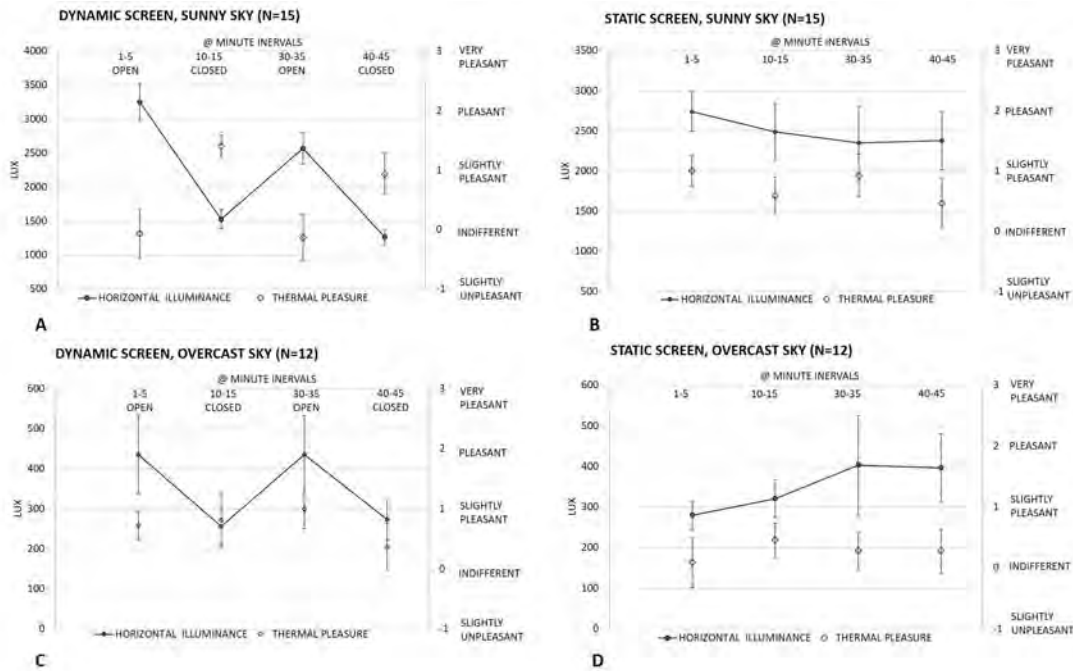
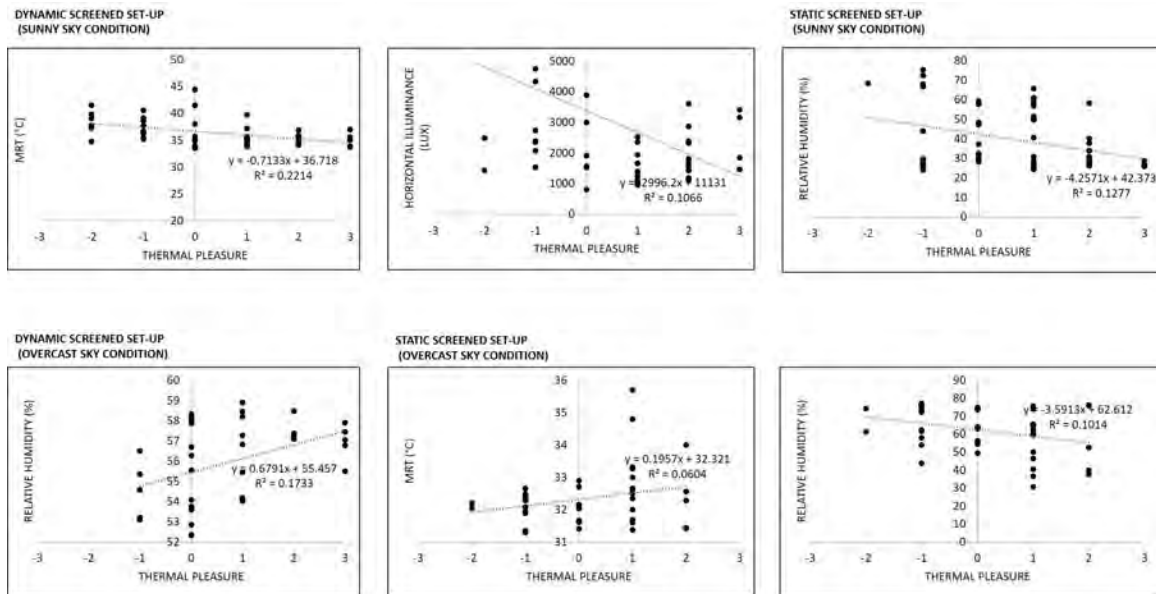


Figure 4: Participants' thermal sensation and its relationship with their thermal pleasure reporting

Irrespective of the sky conditions, the comprehensive analysis of responses from all the participants inside static and dynamic screened set-ups revealed that thermal pleasure reporting had a significant co-relation with the PMV values; for static set-up  $r^2= 0.36$  ( $p<0.05$ ) for dynamic set-up  $r^2=0.24$  ( $p< 0.05$ ). A deeper analysis was conducted to identify the variables; among the ones that determined PMV values; which impacted thermal pleasure reporting in both the set-ups under different sky conditions.



**Figure 5:** Trend of change in horizontal illuminance and participant reporting of thermal pleasure at regular intervals



**Figure 6:** Relationships that were found significant between indoor thermal-visual variables of the set-ups with respective thermal pleasure responses inside each

The mean radiant temperature significantly impacted thermal pleasure responses inside dynamic screened set-up under sunny sky conditions ( $r^2 = 0.22$ ,  $p < 0.001$ ) and inside the static set-up under overcast sky conditions ( $r^2 = 0.10$ ,  $p < 0.05$ ) (Figure 6). The relative humidity significantly impacted thermal pleasure responses in static screened set-up under sunny sky condition ( $r^2 = 0.12$ ,  $p < 0.005$ ) and dynamic screened set-up under over-cast sky condition ( $r^2 = 0.17$ ,  $p < 0.05$ ) (Figure 6). After visualizing the trend in horizontal illuminance inside the set-ups along-side participants' reporting on thermal pleasure (Figure 5), its relationship with the visual environment was also quantified. It was found that horizontal illuminance also had a significant impact on thermal pleasure inside dynamic screened set-up under sunny sky conditions (Figure 6).

#### 4.0 CONCLUSIONS AND LIMITATIONS

A strong and significant relationship found between thermal pleasure and horizontal illuminance under sunny sky conditions showed that visual environmental changes did impact people's thermal pleasure perception. PMV >1 inside the dynamic screened set-up under sunny sky conditions predicted thermal discomfort (Figure 3-A). When the screen CLOSED from the OPEN position, the drop in PMV values predicted a transition from thermal discomfort towards comfort. Moreover, a sharp drop in horizontal illuminance values from around 3000 lux (300 fc) to lower values indicated a potential reduction in thermal stress associated with higher illuminance. The transition from discomfort/stress to comfort/destress, as understood by the concept of alliesthesia explained participants' reporting on thermal pleasure inside the set-up under sunny sky conditions. Pleasurable thermal sensations "come from the dynamic component of thermoreceptors of skin" (Brager, 2019). The relationship of skin temperature contrasts with thermal pleasure in the screened conditions has been analyzed and reported in a separate forthcoming paper.

Through this study, it was intended to focus on testing the applicability of dynamic screens in moderate climates following the work by Elzeyadi (2017). However, its design intent is universally important and applicable. It pointed towards an approach of creating an occupant-centric façade design for thermal pleasure, in the direction of provision for "experiential delight". Thermal pleasure reporting under overcast sky conditions did not respond to the choreographed movement of the dynamic screen as much as that observed under sunny sky conditions. This may suggest that designing dynamic screens for thermal pleasure could be a more appropriate design application for buildings in hot climates. However, that does not negate the possibility of dynamic screen applications to buildings in moderate and cold climates. While the dynamic screens can provide for thermal pleasure during warm summers in such climates, their designs can be directed to target visual pleasure and a sense of privacy simultaneously. The authors are working on publishing detailed reporting of this study in a scientific journal. Dissemination of findings from the current work will help secure resources to expand this study to other climate zones, screen prototypes, and space types like home offices in post-COVID-19 era.

#### REFERENCES

- Abboushi, Belal, Ihab Elzeyadi, Kevin Van Den Wymelenberg, Richard Taylor, Margaret Sereno, and Grant Jacobsen. 2020. *Assessing the visual comfort, visual interest of sunlight patterns, and view quality under different window conditions in an open-plan office*. LEUKOS : 1-17.
- Alawadhi, Esam M. 2018. *Double solar screens for window to control sunlight in Kuwait*. Building and Environment 144: 392-401.
- ASHRAE 55, Thermal Environmental Conditions for Human Occupancy. 2017. ASHRAE Standard 55-2017, American Society of Heating, Refrigerating and Air-Conditioning Engineers, Atlanta, Georgia
- Bluyssen, Philomena M., Sabine Janssen, Linde H. van den Brink, and Yvonne de Kluizenaar. 2011. *Assessment of wellbeing in an indoor office environment*. Building and Environment 46, no. 12: 2632-2640.
- Boubekri, M., Hull, R. B., & Boyer, L. L. 1991. *Impact of window size and sunlight penetration on office workers' mood and satisfaction: A novel way of assessing sunlight*. Environment and Behavior, 23(4), 474-493
- Brager, G., Zhang, H., & Arens, E. 2015. *Evolving opportunities for providing thermal comfort*. Building Research & Information, 43(3), 274-287.
- Cabanac, Michel. *Physiological role of pleasure*. Science 173, no. 4002 (1971): 1103-1107.
- Chi, D. A., Moreno, D., Esquivias, P. M., & Navarro, J. 2017. *Optimization method for perforated solar screen design to improve daylighting using orthogonal arrays and climate-based daylight modelling*. Journal of Building Performance Simulation, 10(2), 144-160.
- Chi, Doris A., David Moreno, Paula M. Esquivias, and Jaime Navarro. 2011. *Optimization method for perforated solar screen design to improve daylighting using orthogonal arrays and climate-based daylight modelling*. Journal of Building Performance Simulation 10, no. 2: 144-160.
- De Dear, Richard. 2011. *Revisiting an old hypothesis of human thermal perception: alliesthesia*. Building Research & Information 39, no. 2: 108-117.
- Elzeyadi, I. 2009. *Architectural Pride and Environmental Prejudice: The Effect of Personal Status, Historical Value, and Indoor Décor on Occupants Indoor Environmental Quality in Offices*. In the proceedings of 24<sup>th</sup> Passive and Low Energy Architecture conference, Quebec City, Canada, June. 22-24.
- Elzeyadi, I. 2017. *The impacts of dynamic façade shading typologies on building energy performance and occupant's multi-comfort*. Architectural Science Review, 60(4), 316-324.
- Elzeyadi, I. M., & Batool, A. 2017. *Veiled Facades: Impacts of Patterned-Mass Shades on Building Energy Savings, Daylighting Autonomy, and Glare Management in Three Different Climate Zones*. Proceedings of International Building Performance Simulation Association Conference, San Francisco, CA.
- Elzeyadi, Ihab, B. Abboushi, H. Hadipour, and I. Riviera. 2016. *HIGH PERFORMANCE FAÇADES: Measuring the Impacts of Dynamic Shading Prototypes on Indoor Environmental Quality Using Yearly Simulations and Field Tests*. PLEA Cities, Buildings, People: Towards Regenerative Environments, Proceedings: 1023-1032
- Emami, N., & Giles, H. 2016. *Geometric Patterns, Light and Shade: Quantifying Aperture Ratio and Pattern Resolution in the Performance of Shading Screens*. Nexus Network Journal, 18(1), 197-222.

- Equation (1) Reference: [https://www.emesystems.com/uta/documents/UTA\\_ver2A\\_120407.pdf](https://www.emesystems.com/uta/documents/UTA_ver2A_120407.pdf)
- Gandhi, D., Garg, V., Rawal, R., Smith, M. 2014. *The Stone Jaali, a critical inquiry into daylight performance*. Indian Architect and Builder
- Golden, R. N., Gaynes, B. N., Ekstrom, R. D., Hamer, R. M., Jacobsen, F. M., Suppes, T., ... & Nemeroff, C. B. 2005. *The efficacy of light therapy in the treatment of mood disorders: a review and meta-analysis of the evidence*. American Journal of Psychiatry, 162(4), 656-662
- IESNA – Daylight Metrics Committee. (2012, October). Lighting Measurement #83, spatial Daylight Autonomy (sDA) and Annual Sunlight Exposure (ASE)
- ISO 7730, Ergonomics of the Thermal Environment - Analytical Determination and Interpretation of Thermal Comfort Using Calculation of the PMV and PPD Indices and Local Thermal Comfort Criteria (2005)
- ISO, E. (1998). 7726. Ergonomics of the Thermal Environment-Instruments for Measuring Physical Quantities (ISO, 7726, 1998).
- Kingma, B. R. M., M. Schweiker, A. Wagner, and W. D. van Marken Lichtenbelt. 2017. *Exploring internal body heat balance to understand thermal sensation*. Building Research & Information 45, no. 7: 808-818.
- Lai, K., Wang, W., & Giles, H. 2017. *Solar shading performance of window with constant and dynamic shading function in different climate zones*. Solar Energy, 147, 113-125.
- Mousa, W. A. Y., Lang, W., & Auer, T. 2017. *Assessment of the impact of window screens on indoor thermal comfort and energy efficiency in a naturally ventilated courtyard house*. Architectural Science Review, 60(5), 382-394.
- Naik, N. & Elzeyadi, I. 2020 a. *Investigating the impacts of Solar Screens on Occupant's Thermal Comfort: An Observational Field Study*. In proceedings of American Society of Heating Refrigeration and Air Conditioning Engineers Winter Conference, ASHRAE Transactions, Volume 126, Part 1
- Naik, N. & Elzeyadi, I. 2020 b. *External Dynamic Screens for Thermal Delight and 'Alliesthesia'*. In the proceedings of Associate Collegiate Schools of Architecture 108th Annual Meeting, San Diego, CA, USA.
- Naik, N. & Elzeyadi, I. 2020 c. *The Impact of Static and Dynamic Solar Screens on the Indoor Thermal Environment and Predicted Thermal Comfort*. In the proceedings of 35th Passive and Low Energy Architecture conference, A Coruna, Spain, Sept. 1-3.
- Nicol, J. F., & Roaf, S. 2017. *Rethinking thermal comfort*.
- Ortiz, M. A., Kurvers, S. R., & Bluysen, P. M. 2017. *A review of comfort, health, and energy use: Understanding daily energy use and wellbeing for the development of a new approach to study comfort*. Energy and Buildings, 152, 323-335.
- Parkinson, T., & De Dear, R. 2015. *Thermal pleasure in built environments: physiology of alliesthesia*. Building Research & Information, 43(3), 288-301.
- Partonen, T., & Lönnqvist, J. (2000). *Bright light improves vitality and alleviates distress in healthy people*. Journal of Affective disorders, 57(1), 55-61
- Reinhart, Christoph. 2015. *Opinion: Climate-based daylighting metrics in LEEDv4-A fragile progress*. Lighting Research and Technology 47, no. 4: 388
- Ryan, Catherine O., and William D. Browning. *Biophilic design*. Sustainable Built Environments (2020): 43-85.
- Sabry, H., Sherif, A., Gadelhak, M., & Aly, M. 2014. *Balancing the daylighting and energy performance of solar screens in residential desert buildings: Examination of screen axial rotation and opening aspect ratio*. Solar Energy, 103, 364-377.
- Schweiker M. 2020. *Rethinking resilient comfort-definitions of resilience and comfort and their consequences for design, operation, and energy use*. In the proceedings of 11th Windsor Conference: Resilient Comfort :34–46. ISBN 978-1-9161876-3-4
- Sherif, A., Sabry, H., & Rakha, T. 2012. *External perforated Solar Screens for daylighting in residential desert buildings: Identification of minimum perforation percentages*. Solar Energy, 86(6), 1929-1940.
- Traylor, C., Zhao, W., & Tao, Y. X. 2019. *Utilizing modulating-temperature setpoints to save energy and maintain alliesthesia-based comfort*. Building Research & Information, 47(2), 190-201
- van Marken Lichtenbelt, W., Hanssen, M., Pallubinsky, H., Kingma, B., & Schellen, L. 2017. *Healthy excursions outside the thermal comfort zone*. Building Research & Information, 45(7), 819-827

# Shape-Shifters: Mobile Thermal Boundaries for Variable Occupancies in Native American Homes

Malini Srivastava<sup>1</sup>

<sup>1</sup>University of Minnesota, Twin Cities, MN

**ABSTRACT:** Zero-H, a research project supported by a NSF Planning grant, integrated community focus groups to develop design concepts for affordable, high-performance single family residence design concepts for Native American communities in the Dakotas. Per the 2010 US Census, 39.8% of Native Americans in North Dakota live below the poverty line. Poverty exacerbates the energy burden. To add to these problems, per the Energy Information Administration, North Dakota has the highest energy expenditure per person in the nation. Additionally, from focus group discussions, the research team learned that variable family structures that can shrink or grow rapidly in a matter of hours (range from 4-19 household occupants in the focus group), are a common phenomenon and not addressed by inadequate one-size-fits-all housing solutions.

The goal for the architectural team within the research group was to develop concepts of affordable high-performance housing where initial construction costs and ongoing operational costs are substantially lowered. The team used the Passive House criteria as a way to reduce operational energy costs by 80%. In addition, the architecture team developed the concept of interior, mobile, super-insulated wall systems which perform as variable internal thermal boundaries that can be adjusted to variable occupant loads. The hypothesis tested was that the Passive House design with mobile thermal boundaries that allowed enclosed volume to be made proportional to the occupant load, is more efficient than the same Passive House design without mobile internal thermal boundaries. Simulation tests with WUFI energy modeling included multiple occupancy loads and volumes in design configurations with and without mobile interior thermal boundaries. The preliminary results of this research showed that the Passive House design with internal thermal boundaries which can be adjusted to occupant load performs better than the Passive House of comparable treated internal volume without internal thermal boundaries.

**KEYWORDS:** Energy burden, Passive House, Mobile Thermal Boundaries, Native American Housing, North Dakota.

## INTRODUCTION

In 1996, with the passage of the Native American Housing and Self-Determination Act (NAHASDA), it was anticipated that the undersized, cookie-cutter HUD housing era would end since tribes were granted the authority over HUD funds. In 2010-2011, the Intertribal Council on Utility Policy (COUP) conducted a survey of tribal interest in green homes, designed to stimulate a national conversation among tribes on building codes. Of the 39 tribes that responded 34 reported that they were aware they can adopt their own codes when building with federal funds. However, 23 tribes worried that existing codes do not reflect cultural values. In response to a question on tribes' hopes for new codes, reductions in energy consumption and healthy indoor air quality were the first and second responses (Seltenrich 2012). In the Seldenrich NIH report, it was noted that, "in 2001 that at least 320 homes in a single housing development on North Dakota's Turtle Mountain Indian Reservation were contaminated with mold, two-thirds of them so severely that they had to be destroyed. Exposure to indoor mold has been strongly linked to asthma symptoms and hypersensitivity pneumonitis in sensitive people as well as wheeze, cough, and upper respiratory tract symptoms. There also is evidence exposure may contribute to asthma development, lower respiratory illness, mucous membrane irritation, immune diseases, neurologic and gastrointestinal problems, skin symptoms, shortness of breath, and lung bleeding among infants....In 2010 the prevalence of asthma in Native and Black adults was 10.5%, compared with 7.8% in white adults. Among Native children, asthma prevalence in 2004–2005 was 9.9%, compared with 7.9% in whites and 12.9% in blacks (more recent data are unavailable)."

In 2011, a National Tribal Green Building Codes Summit created a commitment that. "We, the participants of the National Tribal Green Building Codes Summit, recognize the dire need for healthy, affordable homes and high performance, sustainable buildings in Indian Country. Native Nations have high levels of; homelessness, severely crowded homes, a lack of adequate water and sanitation systems, poor indoor air quality, a high percentage of poorly insulated, and non-electrified homes... It is estimated that well over 200,000 housing units are needed to provide adequate housing in tribal areas. While there is an urgent need to supply more housing, it is recognized that homes must be built in such a way to meet the environmental, social and cultural priorities of Tribal people." (EPA 2011)

## 1.0 PHASE 1: LISTENING TO THE COMMUNITY VOICE

Having the community voice lead the problem definition and solution priorities was imperative for the research team. Phase 1 of the research included community engagement conducted in two stages. Stage 1 included interviews of a group of key stakeholders which included directors and managers of Housing Authorities, faculty and administrators in Tribal colleges, community leaders (pastor, artist, community organizers). Based on the stakeholder interviews, Stage 2 was developed and implemented which included an artist-mediated community focus group around a structured set of specific questions. Stage 2 focus group conversations were conducted by [name of faculty member, not author] and [name of faculty member, not author] on the research team.

### 1.1. Stakeholder Interviews and focus groups

The community stakeholder interviews revealed two key problems and suggested some key approaches as being fundamental to the success of housing programs, especially those focused on energy efficiency. First, housing needs in the North Dakota tribal areas are greatly underserved both in quantity and in quality. For example, the Housing Authority in Fort Yates maintains 1000+ units while 400+ prospective homeowners remain on the waiting list. The poor condition of the existing housing included holes in walls, waterline breaks, inadequate insulation, black mold, moisture in basements and bathrooms, vandalism such as broken windows that are too frequent to be maintained on the Housing Authority budget. Second, most stakeholders made note of overcrowding in homes with as many as 18+ occupants in homes. Also noted was that numbers of occupants may change frequently and drastically. These variable occupancies are not adequately served by the most common 3-4 bedroom home.

Using an art mediated activity that included a photography and group mapping exercise, the key problems that were identified by the focus group members belonged in two categories. First, the inadequacy of housing for certain demographics and second, the complexities of accessing financing due to market barriers. The key issues identified were that severe housing gaps exist for single women and single mothers, and that numbers of occupants can shift rapidly due to family changes and can result in severe overcrowding at times. The home designs don't adequately address rapid shifts in occupant loads. Access to adequate financing from open markets due to complexity of building on fee lands and rust lands were identified as creating considerable financial barriers.

Some of the housing inadequacies related to demographic groups or family sizes were also confirmed by a study commissioned by the Housing and Urban Development Authority (Figure 1) which indicated larger percentage of American Indian and Alaskan Native (AIAN) households are single parent households as compared to the Non-American Indian and Alaskan Native Households (non-AIAN). Using 2009–2011 ACS 3-year estimates, the U.S. Census Bureau found that AIAN households have a larger share of families living in multigenerational households (about 11 percent) than the total population (5.6 percent) (Lofquist, 2013). They also reported that, "In 2010, the percentage of AIAN households that consisted of single-parent families (17 percent) was much higher than that of non-AIAN households (9.5 percent)...Overall, 12 percent of AIAN households consisted of female-headed families with children compared with 7.1 percent of non-AIAN households. The relatively high share of AIAN female-headed households is of particular concern because they are more likely to experience housing hardship and instability than married parents (Manning and Brown, 2006). From literature research, focus groups, stakeholder interviews, the research team grouped the housing problems in two broad categories. First, the structural work that needs to be done in order to create effective economic and employment partnerships to address the housing barriers on native lands such as land ownership, access to financing, development of expertise and qualified personnel in or near the native lands through robust training programs, building homeowner engagement and investment in housing. Second problem was the housing gaps within various types of family structures in Native communities which was also supported by Pindus et al (2017) findings of American Indian and Alaskan Natives household types. This paper focuses on the problem of design solutions for variable occupant loads that are affordable and lead to lowering of operational energy costs.

In the literature, this variability is typically addressed most commonly as overcrowding. According to the Pindus et al (2017) study commissioned by HUD, 15.9% American Indian and Alaskan Native (AIAN) households were experiencing overcrowding versus 2.2% households in the general US population. This study generally confirmed what has become the conventional wisdom about homelessness in Indian Country; namely that, in tribal areas, homelessness mostly translates into overcrowding rather than having people sleeping on the street. The study estimated that, at the time of the household survey in 2013–2015, between 42,000 and 85,000 people in tribal areas were staying with friends or relatives only because they had no place of their own; that is, they were homeless. According to the study, it was generally understood that AIAN families in tribal areas who do have housing tend to take in family members and others who do not have a place to stay. According to the household survey, 19 percent of household heads said they had more household members than could live in their unit comfortably (somewhat more than the 16 percent that were overcrowded by the HUD standard) and 17 percent said they did have some household members that were there only because they had no other place to stay. Very few of the heads of these households (19 percent) said they would ask these people to leave, but the vast majority (80 percent) of the people involved would like to get a place of their own if they could. This 17 percent of households represents the first sample-based estimate ever



made related to this form of homelessness in tribal areas nationwide. Further, this study estimates that the number of people in these households with no place else to stay (that is, the doubled-up homeless) totaled between 42,000 and 85,000—between 3.6 and 7.2 percent of the total 2013–2015 AIAN population in tribal areas.”

The most common solution proposed in the literature is to construct more quantities of quality housing. Targeting larger quantities of housing with limited funding does not address fundamental systemic problems and may even exacerbate problems such as poor quality of construction and all the resulting health impacts of poor quality of design and construction. This research proposes that while greater quantities of housing are needed, providing cost-effective, better quality homes that accommodate variable family structures, which dramatically reduce operating costs due to drastic reductions in energy use might be a more robust short- and long-term solution, while more systemic, economic work is done in addressing root causes such as poverty and homelessness which in turn need to address economic and educational structures.

**2.0 PHASE 2: DESIGN OF VARIABLE INTERIOR THERMAL BOUNDARIES**

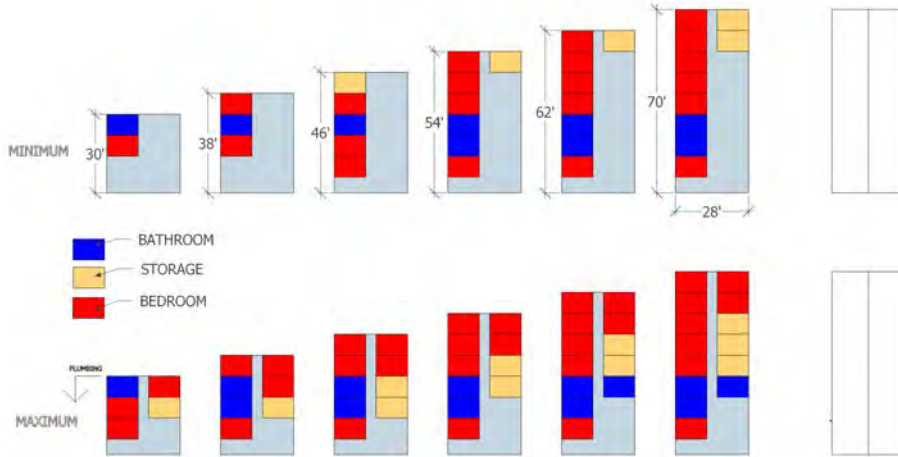
Drawing inspiration from the longhouse (recognizing that communities living on North Dakota native lands will not be served by literal translations of the longhouse and that the Iroquois longhouse from the northeast is not vernacular to the North Dakota tribes), which is a common housing type built to house up to twenty or more families with some family linkages. Longhouses were a combination of extended and nuclear family spaces delineated by log or split-log interior walls. While the exterior walls and roofs were made weatherproof with strips of woven bark woven through log constructions and exterior roofs were made weatherproof with leaves and grasses on framed structures, the houses were built in a manner that there was no permanent fastening, parts of the buildings were held in place by rocks or tying. Thus as the families migrated or moved seasonally, the planks, logs etc. were untied or untethered and moved. Extended and nuclear families were accommodated with hearths that could be both communal for the extended family and distributed for the nuclear group.

This research proposes a simple 2-storey residential design that meets the criteria for Passive House<sup>1</sup> performance criteria for Passive House International United States (PHIUS) 2015+ in Climate Zone 7 in Fargo, ND. PHIUS anticipates that the average increase in cost to meet Passive House standard over building code ranges from an additional 5-10%. The standard design (Figure 1, Residence A) for the test diagram has a rectangular footprint which incorporates two or more bedrooms, two or more full bathrooms, kitchen, large open living area, full laundry, storage space and mechanical room. If the exterior envelope design is based on Passive House two important factors emerge. First, ventilation air is adequate to meet the heating demands of the occupants. Second, the occupants are counted and modeled as internal heat sources. Thus the number of occupants and their resulting heat output becomes proportional to the enclosed volume. In other words, more occupants can heat up larger enclosed volumes, fewer occupants can heat up smaller volumes. Therefore, inspired by the longhouses and Passive House principles, this research proposes the addition of interior partition walls that are super-insulated internal mobile thermal boundaries with unchanging exterior envelope volumes (Figure 2, Residence B). When there are fewer occupants the internal thermal boundaries can be moved to decrease the enclosed volume. When additional occupants join the household, the internal boundaries can be moved to enclose larger volumes, proportional to occupant thermal output and the space needs. The team’s conjecture was that the internal thermal walls that are adjusted based on variable occupancy can be more energy efficient since they make the conditioned volume proportional to the occupant load, essentially allowing the house to internally “shift shape” based on the occupancy. Further, our (untested) conjecture for future research is that since these interior mobile walls are internal boundaries that do not need the typical control layers (moisture retarders, vapor retarders etc.), they can be constructed inexpensively and can be lightweight. When not in use, the walls could be stacked up against the North wall or other exterior walls of the residence, to provide additional insulation potentially providing additional efficiency. In all these examples (Residence A and B), the exterior thermal boundaries of the house are insulated to meet Passive House standard in order to ensure that heating requirements can be met with ventilation air. We conducted energy modeling calculations using WUFI software for the following area and volume configurations (Table 3):

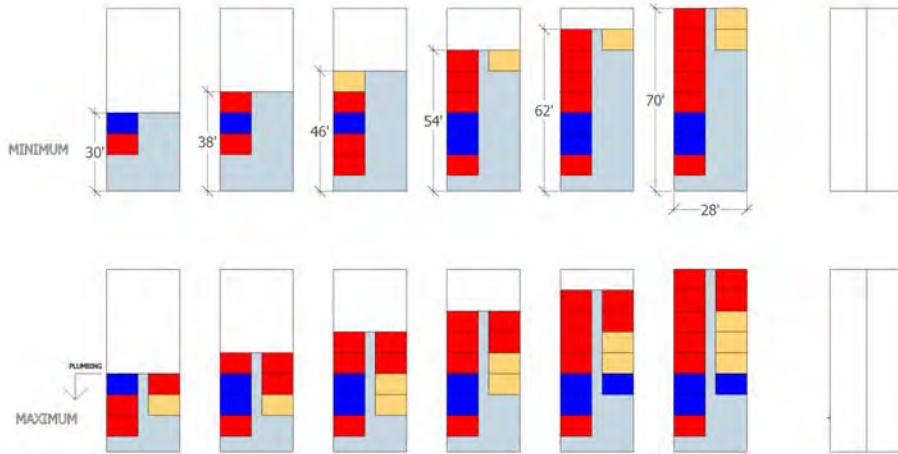
**Table 1:** Area and volumes of Residence A and Residence B

<i>Length [ft]</i>	30	38	46	54	62	70
<i>Width [ft]</i>	28	28	28	28	28	28
<i>Height [ft]</i>	9	9	9	9	9	9
<i>Area [ft<sup>2</sup>]</i>	840	1,064	1,288	1,512	1,736	1,960
<i>Volume [ft<sup>3</sup>]</i>	7,560	9,576	11,592	13,608	15,624	17,640

Figure 1 describes Residence Type A where the external thermal boundary defines the volume and area of space being heated or cooled for comfort purposes as would be the case in any typical design. In comparison, Figure 2 shows Residence Types B, where the exterior envelope remains constant (white rectangle), and the conditioned volume is defined by a mobile internal thermal boundary. In Residence Type A there is no provision for variable occupancy. In Residence Type B the mobile internal thermal boundaries can be changed to adapt to functional and thermal requirements.



**Figure 1** Residence A: Floor plan line diagram showing minimum and maximum occupancy/program. Each size configuration is designed for a specific occupancy range between programmatic minimum and maximum



**Figure 2** Residence B: Floor plan line diagram showing minimum and maximum occupancy/program. Constant external boundaries that remain fixed with variable internal boundaries configured to a range of occupancy between programmatic minimum and maximum (these can be configured based on occupant loads)

**Table 2:** Minimum/Maximum Occupancy based on number of bedrooms and length

Length	Bedrooms	Code		PHA		WUFI - with PV		WUFI - without PV	
	Min / Max	Min	Max	Min	Max	Min	Max	Min	Max
	0			1	1				
30'	1	1	6	1	4	3	6	4	6
38'	2	2	8	2	6	4	8	5	8
36'	3	3	10	4	8	5	10	5	10
54'	4	4	12	6	10	6	12	6	12
62'	5	5	14	8	12	6	14	7	14
70'	6	6	16	10	14	7	16	8	16

**2.1 PHASE 3: PRELIMINARY RESULT COMPARISON OF RESIDENCE A and B**

Several test scenarios were conducted in WUFI modeling. Minimum and maximum occupancy scenarios (Table 2) were tried for the various conditioned volumes. Table 2 describes the occupancy ranges for the homes which was determined based on three criteria: (a) design based on building code; (b) Occupancy based on PHA (Public Housing Authority) values are from Chapter 5 of the Housing Choice Voucher Program Guidebook; (c) Occupancy based on WUFI energy modeling (values with photovoltaic solar and without). Variables included testing with and without solar array and testing with or without tempering or heating of the space beyond the interior thermal boundary in Residence B design.

TEST CASE 1: Minimum Occupancy, with no solar energy.

**Table 3:** Test Case 1a: In Residence B, the unoccupied space beyond the interior thermal boundary is not tempered or heated.

MINIMUM Length (ft)	RESIDENCE B						Target Length (ft)	RESIDENCE A					
	30'-0"	38'-0"	46'-0"	54'-0"	62'-0"	70'-0"		30'-0"	38'-0"	46'-0"	54'-0"	62'-0"	70'-0"
Heating Demand	5.57	5.18	5.55	5.39	5.23	5.07	8.00	5.62	5.22	5.58	5.40	5.28	5.11
Cooling Demand	1.45	1.18	0.81	0.69	0.62	0.60	2.20	1.46	1.19	0.81	0.69	0.62	0.58
Heating Load	5.68	5.38	5.17	5.06	4.97	4.91	6.00	5.69	5.38	5.17	5.06	4.97	4.89
Cooling Load	1.73	1.57	1.37	1.23	1.16	1.11	4.20	1.74	1.58	1.37	1.24	1.16	1.10
Source Energy	5,272	5,496	6,049	5,900	5,818	5,717	6,200	5,284	5,506	6,059	5,923	5,825	5,758
Site Energy	40.54	40.38	38.74	38.28	38.02	37.80		40.71	40.52	38.85	38.41	38.10	37.70
BEDROOM	1	2	3	4	5	6		1	2	3	4	5	6
WUFI Occ	4	5	5	6	7	8		4	5	5	6	7	8
DESIGN Occ	1	3	4	5	6	7		1	3	4	5	6	7

The results of the WUFI energy modeling for Passive House performance, reveal that for a minimum occupancy with no solar array, and with or without the tempering or heating of the enclosed but unoccupied space beyond the interior thermal boundary; in most cases (variations in size, area, volume), the heating demand, heating load, source energy and site energy are marginally lower in Residence B than Residence A. The only exception is the cooling demand and cooling load are marginally higher for the largest homes of 62'-0" and 70'-0" lengths in Residence B in Test Case 1a. In Test Case 1b, the cooling demand, heating load and cooling load are marginally higher for the largest home of 70'-0" length in Residence B.

**Table 4:** Test Case 1b: In Residence B, the unoccupied space beyond the interior thermal boundary is tempered or heated.

	RESIDENCE B							Target <i>t</i>	RESIDENCE A						
	30'-0"	38'-0"	46'-0"	54'-0"	62'-0"	70'-0"	30'-0"		38'-0"	46'-0"	54'-0"	62'-0"	70'-0"		
<b>MINIMUM</b>															
Heating Demand	4.73	5.00	4.97	4.97	4.83	4.69	8.00	5.53	5.22	5.58	5.48	5.45	5.19		
Cooling Demand	1.46	1.01	0.81	0.68	0.62	0.60	2.20	1.50	1.19	0.81	0.69	0.58	0.56		
Heating Load	5.33	5.03	4.94	4.85	4.80	4.75	6.00	5.69	5.38	5.17	5.05	4.97	4.89		
Cooling Load	1.76	1.57	1.39	1.25	1.17	1.12	4.20	1.76	1.58	1.37	1.25	1.12	1.08		
Source Energy	5,076	6,070	5,880	5,724	5,696	5,611	6,200	5,311	5,506	6,059	5,889	5,723	5,734		
Site Energy	37.50	36.69	36.63	36.51	36.45	36.40		40.66	40.52	38.85	38.45	38.06	37.79		
BEDROOM	1	2	3	4	5	6		1	2	3	4	5	6		
WUFI Occ	4	4	5	6	7	8		4	5	5	6	7	8		
DESIGN Occ	1	3	4	5	6	7		1	3	4	5	6	7		

TEST CASE 2: Minimum & Maximum Occupancy, with 1000kWh/yr solar array.

Given the community's interest in achieving Net Zero with photovoltaics, the team tested the design concept with a 1000 kWh solar array for minimum and maximum occupancies. As in Test Case 1, Residence A is the typical Passive House design. Residence Type B is where the exterior envelope always remains constant, and there are mobile internal thermal boundaries. In Residence Type A there is no provision for variable occupancy. In Residence Type B the mobile internal thermal boundaries can be changed to adapt to functional and thermal requirements. In Residence B, the unoccupied space beyond the interior thermal boundary was tested as both tempered or heated and not tempered or heated.

**Table 5:** Test Case 2a: Minimum occupancy, unoccupied space beyond the interior thermal boundary is not tempered or heated.

	RESIDENCE B							Target <i>t</i>	RESIDENCE A						
	30'-0"	38'-0"	46'-0"	54'-0"	62'-0"	70'-0"	30'-0"		38'-0"	46'-0"	54'-0"	62'-0"	70'-0"		
<b>MINIMUM</b>															
Heating Demand	6.14	5.69	5.55	5.36	5.61	5.39	8.00	6.19	5.73	5.58	5.37	5.66	5.42		
Cooling Demand	1.24	1.00	0.81	0.67	0.52	0.53	2.20	1.25	1.00	0.81	0.68	0.52	0.51		
Heating Load	5.60	5.32	5.17	5.07	4.94	4.87	6.00	5.60	5.32	5.17	5.07	4.94	4.85		
Cooling Load	1.74	1.55	1.37	1.20	1.12	1.11	4.20	1.75	1.55	1.37	1.21	1.11	1.10		
Source Energy	5,968	5,963	5,796	5,713	6,184	6,025	6,200	5,984	5,976	5,806	5,736	6,167	6,073		
Site Energy	37.83	37.93	37.68	37.40	36.62	36.57		38.01	38.08	37.80	37.53	36.67	36.50		
BEDROOM	1	2	3	4	5	6		1	2	3	4	5	6		
OCCUPANT	3	4	5	6	6	7		3	4	5	6	6	7		

**Table 6:** Test Case 2b: Maximum occupancy, unoccupied space beyond the interior thermal boundary is not tempered or heated.

	RESIDENCE B							Target <i>t</i>	RESIDENCE A						
	30'-0"	38'-0"	46'-0"	54'-0"	62'-0"	70'-0"	30'-0"		38'-0"	46'-0"	54'-0"	62'-0"	70'-0"		
<b>MAXIMUM</b>															
Heating Demand	4.63	3.94	3.26	2.63	2.53	2.30	8.00	4.67	3.98	3.29	2.65	2.61	2.34		

<i>Cooling Demand</i>	2.03	1.93	2.04	2.19	2.13	2.18	2.20	2.04	1.94	2.05	2.19	2.09	2.11
<i>Heating Load</i>	5.96	5.67	5.58	5.54	5.41	5.35	6.00	5.96	5.67	5.59	5.54	5.41	5.32
<i>Cooling Load</i>	1.72	1.67	1.57	1.47	1.53	1.54	4.20	1.73	1.67	1.57	1.48	1.50	1.52
<i>Source Energy</i>	4,132	4,375	4,265	4,323	4,354	4,431	6,200	4,139	4,380	4,269	4,325	4,299	4,443
<i>Site Energy</i>	43.03	45.03	47.20	49.56	49.42	50.12		43.19	45.15	47.30	49.64	49.07	49.70
<i>BEDROOM OCCUPANT</i>	3	4	5	6	7	8		3	4	5	6	7	8
	6	8	11	14	16	18		6	8	11	14	16	18

**Table 7:** Test Case 2c: Minimum Occupancy, unoccupied space beyond the interior thermal boundary is tempered or heated.

RESIDENCE B							<i>Target</i>	RESIDENCE A					
<i>MINIMUM</i>	30'-0"	38'-0"	46'-0"	54'-0"	62'-0"	70'-0"		30'-0"	38'-0"	46'-0"	54'-0"	62'-0"	70'-0"
<i>Heating Demand</i>	5.26	5.00	4.97	4.86	5.17	5.00	8.00	6.19	5.73	5.58	5.37	5.66	5.42
<i>Cooling Demand</i>	1.25	1.01	0.81	0.67	0.52	0.53	2.20	1.25	1.00	0.81	0.68	0.52	0.51
<i>Heating Load</i>	5.24	5.03	4.94	4.87	4.77	4.72	6.00	5.60	5.32	5.17	5.07	4.94	4.85
<i>Cooling Load</i>	1.77	1.57	1.39	1.21	1.13	1.12	4.20	1.75	1.55	1.37	1.21	1.11	1.10
<i>Source Energy</i>	5,690	5,754	5,627	5,571	6,038	5,901	6,200	5,984	5,976	5,806	5,736	6,167	6,073
<i>Site Energy</i>	34.64	35.41	35.57	35.61	35.01	35.13		38.01	38.08	37.80	37.53	36.67	36.50
<i>BEDROOM OCCUPANT</i>	1	2	3	4	5	6		1	2	3	4	5	6
	3	4	5	6	6	7		3	4	5	6	6	7

**Table 8:** Test Case 2d: Maximum Occupancy, unoccupied space beyond the interior thermal boundary is tempered or heated.

RESIDENCE B							<i>Target</i>	RESIDENCE A					
<i>MAXIMUM</i>	30'-0"	38'-0"	46'-0"	54'-0"	62'-0"	70'-0"		30'-0"	38'-0"	46'-0"	54'-0"	62'-0"	70'-0"
<i>Heating Demand</i>	3.86	3.36	2.81	2.28	2.22	2.03	8.00	4.67	3.98	3.29	2.65	2.61	2.34
<i>Cooling Demand</i>	2.04	1.94	2.05	2.19	2.14	2.18	2.20	2.04	1.94	2.05	2.19	2.09	2.11
<i>Heating Load</i>	5.56	5.39	5.35	5.34	5.24	5.19	6.00	5.96	5.67	5.59	5.54	5.41	5.32
<i>Cooling Load</i>	1.75	1.69	1.59	1.49	1.54	1.55	4.20	1.73	1.67	1.57	1.48	1.50	1.52
<i>Source Energy</i>	4,018	4,293	4,211	4,284	4,320	4,402	6,200	4,139	4,380	4,269	4,325	4,299	4,443
<i>Site Energy</i>	40.30	42.95	45.60	48.32	48.34	49.18		43.19	45.15	47.30	49.64	49.07	49.70
<i>BEDROOM OCCUPANT</i>	3	4	5	6	7	8		3	4	5	6	7	8
	6	8	11	14	16	18		6	8	11	14	16	18

All four cases in Test 2 revealed consistent results in the WUFI energy modeling for Passive House performance. In all cases (variations in size, area, volume, tempering or heating of unoccupied spaces in Residence B, minimum and maximum occupancies), the heating and cooling demand, heating and cooling load, source and site energy are marginally lower in Residence B than Residence A. The only exceptions were in the largest 62'-0" and 70'-0" lengths for Residence B, the cooling demand and cooling loads were marginally higher. In the tests where Residence B area beyond the internal thermal boundary was not heated or tempered, the largest lengths (62'-0" and 70'-0") had either the same or marginally higher heating load. For Case 2d, the cooling load was lower for all sizes of homes for Residence A than Residence B in this case.

## CONCLUSION

This research contends that to be culturally and environmentally responsive is not an added question or burden to the problem of Native homeownership but a solution. However, to accomplish this, further research and field studies are necessary. There is considerable need for a detailed housing study for cultural practices and family structures that are

prevalent and desired, using ethnographic methods. Moreover, the research needs to record the current state of housing with regards to condition, maintenance and any potential health impacts, addressing the energy burdens of the households. Further this study would provide the analysis of potential education-industry partnerships, and the economic potential of green jobs related to the housing sector with the savings implications for health costs.

Further this research shows that potentially cost-effective interior thermal boundaries have generally better performance in Residence B (variable interior thermal boundaries option meeting Passive House performance) than Residence A (typical design meeting Passive House performance) with the exception of cooling load and demand for the largest homes especially for maximum occupancy. Moreover, in Residence Type A there is no provision for variable occupancy whereas Residence Type B specifically addresses the issue of variable family structures and resulting overcrowding problems through the mobile internal thermal boundaries that can be changed to adapt to functional (more square footage) and thermal requirements.

Based on these promising preliminary and early findings, further testing with adjustments in multiple variables and with other performance standards, is needed. Few such variables are the relative R-value configurations and construction types of exterior and interior thermal boundaries, ease of mobility and sealing of internal thermal boundaries, ratio of ideal temperature settings of conditioned enclosed space for human comfort and tempered space beyond the occupied internal thermal boundary but within the exterior enclosure, and lastly, the cost implications of creating internal thermal boundaries and their return on investment.

### ACKNOWLEDGEMENTS

This research was made possible by a Planning Grant from the National Science Foundation. [name of research assistant] as the Graduate Research Assistant on this project conducted the Passive House modeling and testing using WUFI energy modeling software. Additionally, Prof Dominic Fischer (NDSU) and Dr. Rajesh Kavasseri (SDSU) conducted the art-mediated focus group activities that set up the conditions for the research.

### ENDNOTES

1. The Passive House standard for buildings is based on super-insulation, minimizing thermal bridging, airtight construction, and balanced heat- and moisture-recovery ventilation. This standard was used to model for minimizing the operational energy needs for the design solution.

### REFERENCES

- Lofquist, Daphne. "Multigenerational households." In *Annual Meeting of the American Sociological Association, Working Paper*, vol. 20. 2013.
- Manning, Wendy D., and Susan Brown. 2006. *Children's Economic Well Being in Married and Cohabiting Parent Families*. *Journal of Marriage and Family* 68 (2): 345–362.
- Pindus N., Kingsley T G., Biess J., Levy D., Simington J., Hayes C. 2017. *Housing Needs of American Indians and Alaska Natives in Tribal Areas: A Report from the Assessment of American Indian, Alaska Native and Native Hawaiian Housing Needs*. Prepared for the US Department of Housing and Urban Development, Office of Policy Development and Research, Washington DC.
- <https://www.huduser.gov/portal/sites/default/files/pdf/HNAIHousingNeeds.pdf>
- Seltenrich N. 2012. *Healthier tribal housing: combining the best of old and new*. *Environmental health perspectives*, 120(12), A460–A469. doi:10.1289/ehp.120-a460
- <https://www.ncbi.nlm.nih.gov/pmc/articles/PMC3548302/>



# Thermal Preference and Comfort Assessment: Historic Buildings in Hot and Humid Climates

Ezgi Bay<sup>1</sup>, Antonio Martinez-Molina<sup>2</sup>

<sup>1</sup>Illinois Institute of Technology, Chicago, IL

<sup>2</sup>University of Texas, San Antonio, TX

**ABSTRACT:** Research on Post-Occupancy Evaluation (POE) in historic buildings has increased exponentially in recent years. Religious structures are a critical asset to the heritage building stock and a significant field of study due to the particular occupancy patterns and the impact of indoor microclimate on the occupants' thermal comfort satisfaction. Based on recent research literature, this paper compares a quantitative and qualitative study performed to assess the thermal comfort conditions using occupants' surveys, results of a calibrated energy simulation model, and Predicted Mean Vote (PMV) and Percentage of Dissatisfied (PD) calculations. The study was carried out in a UNESCO world heritage site over a 5-month period. Gathering over 221 questionnaires and data from a 12-data logger network logging air temperature and relative humidity values every 15 minutes, the indoor conditions of an 18th century church in San Antonio were monitored. The PMV and Predicted Percentage of Dissatisfied (PPD) were then calculated using Povl Ole Fanger's method. Using the software IES-VE, the energy simulation model results and the PMV and PD values are compared with real occupants' subjective opinions. The results show a difference among the three calculation methods, particularly during the summer months when the indoor-outdoor thermal leap is larger. Additionally, the comparison reveals that the thermal comfort predictions using computational energy models are more accurate than utilizing Fanger's method. The findings will inform architects, engineers, and researchers in their efforts to promote more efficient and healthy historic spaces and to run POEs of existing religious buildings.

**KEYWORDS:** Thermal comfort; Post-Occupancy Evaluation; Historic building; Energy simulation; Fanger's method.

## INTRODUCTION

Researchers working on historic buildings have acknowledged the positive impact of traditional design and construction techniques in passively controlled environments (Fabbri et al., 2014; Zivković et al., 2015). The well-known environmental metabolism of historic structures is not only about physical characteristics of construction materials, but also to a style and layout, which helps the building's self-control (through elements such as under-roof cavities or other transitional spaces acting as buffers) and, consequently, a more stable response to outdoor environmental variations (Belpoliti et al., 2017). Some additional recent articles have also studied thermal comfort and have monitored the indoor air temperatures and relative humidity levels. A project in Cyprus showed the outcomes from middle-age religious buildings and presented the variations in interior temperatures, relative humidity levels and levels of pollutants exceeding recommended values (Loupa et al., 2006). Varas-Muriel et al. (Varas-Muriel et al., 2014) created and operated a three-dimensional datalogger network to measure heat alterations in a church in Spain. The article determined that traditional heating techniques worked to gather heat in the upper levels of a church while keeping cold air at occupant's height. The gap between standards and reality was argued by Martins and Carlos (Martins et al., 2014), who presented the challenge of keeping temperature control and creating ideal levels of thermal standards in a religious building in Lisbon. In order to evaluate energy performance, the researchers carried out an external wall's assessment with indoor surface sensors. Therefore, the analysis showed that during the summertime, the external walls performed well to minimize the heat flow into the building and the indoor temperature and humidity levels were consequently stable. Nevertheless, during the wintertime the walls could not have been relied on for maintaining thermal comfort levels. The authors then recognized that further actions, such as replacing double-glazed windows and improving heat gains on the south façade, should be taken to guarantee the occupants' thermal comfort in the winter. Research on this topic has grown considerably, especially in the last twenty years (Martinez-Molina et al., 2016). Moreover, the scientific community has found a research niche analyzing indoor environmental conditions of historic buildings due to the number, distribution, occupancy rate and environmental quality of these unique structures (Martinez-Molina et al., 2020; Martinez-Molina et al., 2017; Martinez-Molina et al., 2018). In fact, some papers have recently pointed out that Fanger's method is not very accurate when applied to historic buildings (Teli et al., 2012; Mors et al., 2011; De Giuli et al., 2012).

This manuscript examined and reviewed the outcomes of the research on a historic religious building in San Antonio, Texas, where visitors were actively engaged in gaining an understanding of their satisfaction with the thermal environment during the summer Sunday services. A quantitative objective process with sensors was used to gather

indoor environmental data in order to support the calculation of the Predicted Mean Vote (PMV) and the Predicted Percentage of Dissatisfied (PPD) for the church occupants' thermal comfort measurement. Additionally, another quantitative method via a building energy simulation software was used in order to calculate PMV and PPD as well. Then, these indicators were compared with the feedback from the surveys (the qualitative subjective method). The outcomes and correlations of this paper can be used to determine an accurate thermal comfort assessment in historic buildings and inform potential retrofit interventions in order to improve occupants thermal comfort satisfaction.

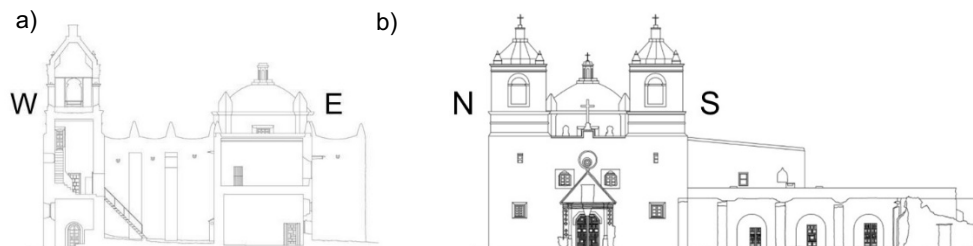
### 1.0 DESCRIPTION OF CASE STUDY

The case study of this paper is the oldest unrestored church in the United States, built in 1755. It is located at Mission La Purisima Concepción de Acuña which was a self-sustained religious complex in San Antonio, Texas. It has been the part of the San Antonio Missions National Historical Park since 1978 and later it became a UNESCO World Heritage Site in 2015. This historic building was constructed from local materials such as limestone for its 84-cm-thick exterior walls and 60-cm-thick interior walls (covered by a white lime-based plaster). This material also used for the 6-meter-tall and 1.5-meter-thick surrounding walls of the complex. A rubble stone fill is seen in the center of the building walls. As shown in Figure 1, the church has a small and limited number of openings. These are wood framed windows, molding with single pane glass and wood panel doors. Martínez-Garrido et al. (Martínez-Garrido et al., 2014) using two networks of wireless dataloggers (indoor and outdoor air temperature and relative humidity monitoring) assessed the differences in relative humidity values along the walls and different heights of a church in Spain. The outcomes displayed that a longer thermal lag in particular wall areas helped to indoor thermal comfort by emitting at night the heat absorbed during the day.



**Figure 1:** Appearance of the church showing the main façade (above) and nave from the main door (below). Source: (Antonio Martínez-Molina, 2019)

As depicted in Figure 2, the main entrance of the church is located in the center of two 18 m tall bell towers. The Tower room is under the left tower when the Baptistry is located under the right one. The Nave of the church holds 11 rows of pews, and two Transepts. The right transept leads into the Sacristy providing access to the back entrance. The only operable windows of the building are located on the north-west façade above the entrance, in the balcony area. The building is naturally ventilated with massive infiltrations due to the very low airtightness. The mechanical system was installed in the 90s and consists of a split system heat pump with a scroll air-conditioning compressor assembly and air-cooled coil, propeller-type condenser fans, and a control box. Since the church is open to visitors between 9:00 and 17:00 daily, the cooling system is working during this period with a constant setpoint of 23°C. Additionally, mass services are conducted weekly on Sundays from 10:00 to 12:00, and the mechanical system is working during these two events as well.



**Figure 2:** Longitudinal section (a) and elevation (b) of the church.

### 1.0 LOCAL CLIMATE

The experiments were carried out in San Antonio, a city located at latitude 29° 25' 26" N, longitude 98° 29' 35" W. San Antonio is 240.5 meters (m) above sea level and has a Cfa-Humid Subtropical Climate but bordering on the west of the

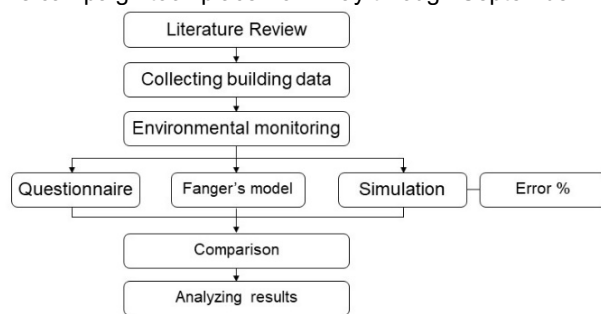
city with a Bsk-Semi-Arid Climate according to Köppen classification. Additionally, according to the ASHRAE climate zones classification, this historic structure is also located in the zone 2A, hot and humid. Average temperatures in summer almost reach 35°C, and average relative humidity levels are above 55% most summer months (Table 1).

**Table 1.** Monthly air temperature and precipitation summary of San Antonio (usclimatedata.com)

	May	June	July	August	September
Average Low Temperature [°C]	18.65	22.09	23.32	23.15	20.48
Average High Temperature [°C]	30.12	33.34	34.84	34.87	32.20
Average Relative Humidity [%]	63.70	66.49	56.91	52.96	55.63
Average Precipitation [mm]	120	0.19	52	65	76

## 2.0. METHODOLOGY

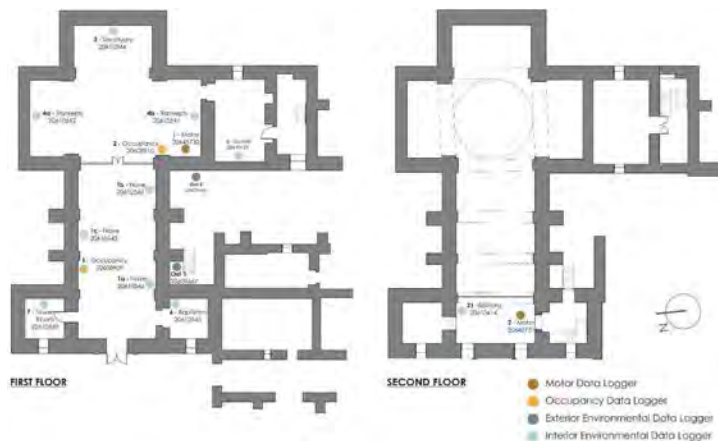
This study was conducted in a religious building equipped with an air-cooling system, for maintaining comfortable building temperatures during summertime. A very detailed data collection campaign was performed combining qualitative (occupants' satisfaction) and quantitative (environmental monitoring and energy simulation) data (Figure 3). This campaign took place from May through September 2019.



**Figure 3:** Flow chart of the research methodology.

### 2.1. Environmental monitoring

A total of 12 data loggers (2 outdoor and 10 indoor data loggers) were evenly distributed in the building to determine air temperature (°C) and relative humidity (%) in order to understand both, indoor and outdoor environments during the monitoring period (May through September 2019). The data-loggers were located away from light fixtures or windows to avoid misleading temperature readings resultant from the additional heat, and as directed by the position prescriptions of ASHRAE 55 (1.10 m for seated occupants and at least 1 m far from external walls) and the requirements of ISO 7726. In order to get a broad range of air temperature and relative humidity values, the sensors were programmed to obtain readings every fifteen minutes. This also enabled the methodology to identify any severe variations during the testing period of each day. Additionally, 2 motor sensors monitored the operation of the HVAC unit and 2 motion sensors recorded occupancy patterns.



**Figure 4:** Motor, occupancy, and environmental data loggers' locations.

### 2.2. Questionnaire

In order to understand what type of thermal comfort opinion occupants had of the indoor environment, the researchers used an investigative qualitative method with surveys as the main instrument. The survey included multiple-choice

together with a brief description of the research project in order to explain any potential doubt and get the most reliable questions (using Likert-type scales) and an open-ended field. The survey was designed based on Fanger's Model (Fanger, 1970) and the ASHRAE 55 (ASHRAE, 2013). Questionnaires were handed out to visitors at the arrival, outcomes. Of the 2,109 visitors during the research period (May through September 2019), 224 filled out surveys. The survey was intended with the goal of obtaining sincere and reliable answers with the following considerations in mind: brevity and simplicity. Indeed, it was improbable that visitors would have filled out the survey if it were too difficult to comprehend, and replies would not have reflected the real experience.

### 2.3. Fanger's model

Fanger's model integrates six elements divided in human (2) and environmental (4) aspects. Environmental parameters (air temperature, radiant temperature, air velocity and relative humidity) were either measured or estimated. However, the human factors such as clothing insulation (*clo*) and metabolic rate (*met*) were calculated according to the ASHRAE 55. A set of outfits that most usually worn in a hot and humid climate was generated and utilized for the diverse outfit choices for occupants, based again on ASHRAE 55 *clo* values. Once the different occupants' outfit combination was gathered through the survey, the final clothing insulation value was calculated. Moreover, over 98% of visitors stated that they got to the building using motorized transportation, not affecting their metabolic rate inside the building. Instead, a 1.2 *met* rate (seating and standing, relaxed) was used for the purpose of Fanger's model calculations.

### 2.4. Energy simulation

In order to model and run the required energy simulation using the IES-VE software (IES-VE 2019), authors collected detailed data consisted of weather information, site data settings, geometry, envelope materials, window profiles and occupants' profile. In particular, the Typical Meteorological Year (TMY) weather data of the city was obtained from the San Antonio Airport Weather Station. The prepared model underwent solar shading analysis and dynamic thermal simulation to attain indoor temperatures, relative humidity, PMV values and occupants' dissatisfaction. Specifically, the Apache module of the software, a Dynamic Simulation Module (DSM), was used for the energy simulation analysis.

The geometry of the structure was modelled in the software based on existing blueprints and observation of the building which helped to conduct in-situ surveys. Despite the impossibility of accurately verifying thicknesses of some architectural elements such as some materials, thicknesses and thermal conductivity of the envelope were estimated in the simulation model. Due to its current conditions such as the direct opening of the northern tower to the outside, this structure was considered very leaky and the infiltration rate was defined as 2.032 l/(s.m<sup>2</sup>). It was assumed that the church's windows had a thermal transmittance (*U<sub>w</sub>*) of 1.2 W/m<sup>2</sup>K. The building's elements assemblies, thicknesses and conductivity of materials can be seen in Table 3. The thermal conductivity of the building envelope has provided relatively constant indoor temperatures due to the building's heat storage capacity, since limestone is the main material for the structure with a porosity of n=0-40% and density of 1760-2160 kg/m<sup>3</sup>, at least until the mechanical system was installed. Despite its high sun exposure during the summer months, solar radiation does not have a significant impact on the northern and southern walls, compared to other facades and the roof. Additionally, a poor 4% window-to-wall ratio is an effective determinant factor for the building to prevent the transmission of solar radiation in this climate. Since the majority of the building occupancy is expected on Sundays, the comparison of calculated and measured user dissatisfaction was done on these days. Based on in-situ observations, lighting, people and equipment were defined as internal loads. Over 200 people were defined in the chancel during the mass period that is between 11am and 1pm. Weekly cooling operation profile of the building was created between 9am and 7pm with a cooling setpoint of 24.4°C (76°F). Also, for humidity control, the percentage of saturation lower and upper limits was set as 55% and 65%, respectively. Finally, the energy model was validated by using a typical summer design day. Based on the relative errors between measured and simulated indoor air temperature and relative humidity values, the model was considered successful.

**Table 3:** Thickness and conductivity of the building envelope and openings

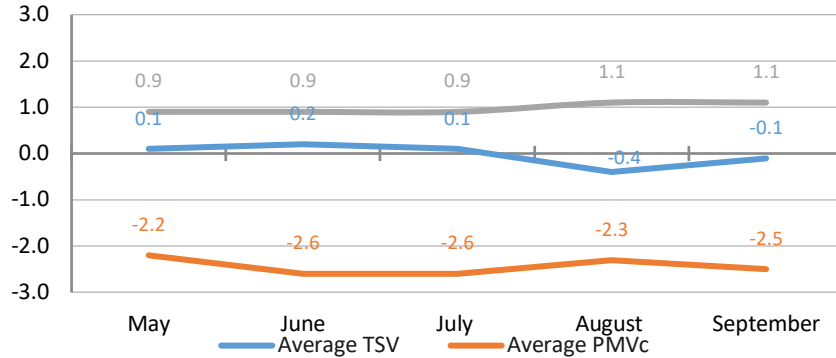
Building components	Material	Thickness [m]	Conductivity [m <sup>2</sup> K/W]
<i>Walls</i>	Limestone	1.04	0.0595
<i>Partitions</i>	Limestone	1.04	0.0595
<i>Roof</i>	Concrete	0.1	0.05
<i>Ground floor</i>	Concrete	0.304	0.08
<i>Windows</i>	Single glazing	0.006	0.7793

### 3.0. OUTCOMES

This section presents the results and comparison of the products of the qualitative analysis through surveys, quantitative data monitoring through data loggers and the simulation results, in order to evaluate visitors' thermal opinion with the indoor environment and its accuracy with real data. These outcomes are divided in two sections: thermal satisfaction through Thermal Sensation Vote (TSV) and Predicted Mean Vote (PMV); and Predicted Percentage of Dissatisfaction (PPD).

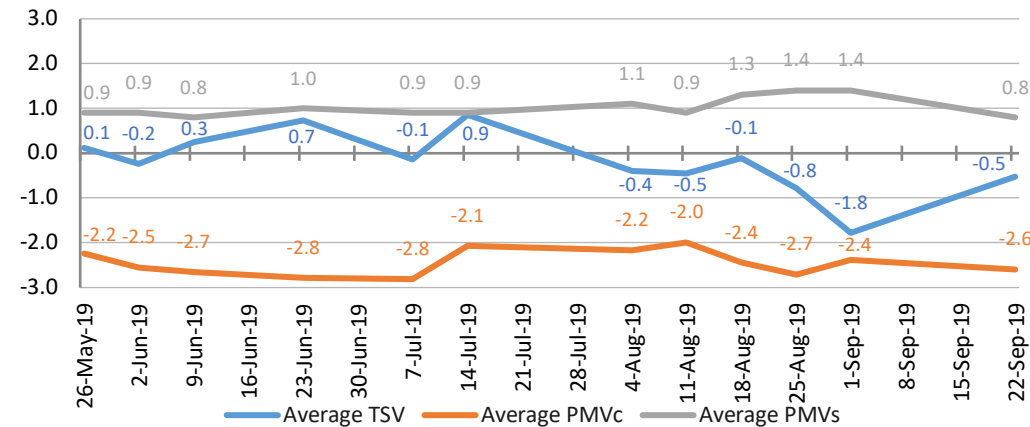
**3.1. Comparison of measured, calculated and simulated Predicted Mean Vote PMV.**

Overwhelmingly, visitors’ answers (TSV), calculated (PMVc) and simulated (PMVs) regarding indoor thermal conditions did not align, as shown in Figure 4. TSV and PMVs values have a slight difference of approximate 1 unit or less, resulting higher the simulated parameters (between 0.9 and 1.1) than the real visitors answers (between -0.4 and 0.2). Therefore, the TSV values always fall within the comfortable parameters accepted by the ASHRAE 55 (between -0.5 and +0.5), making all the simulation results unacceptably hotter, even slightly. On the other hand, the calculated average monthly values are consistently below the satisfactory scope, ranging between -2.2 in May and -2.6 in June and July. The most obvious case of this was in June and July, which are two of the three hotter months of the timeframe studied (Table 1). Hence, we can assume that the differences in the PMVc were affected only by outdoor temperatures and, therefore, by the difference between indoor and outdoor temperatures (thermal leap). As relative humidity values became lower over the end of the summer months (August and September), reports of the indoor conditions being colder increased to vaguely get closer to the PMVs.



**Figure 5:** Comparison between TSV, PMVc and PMVs average values by month.

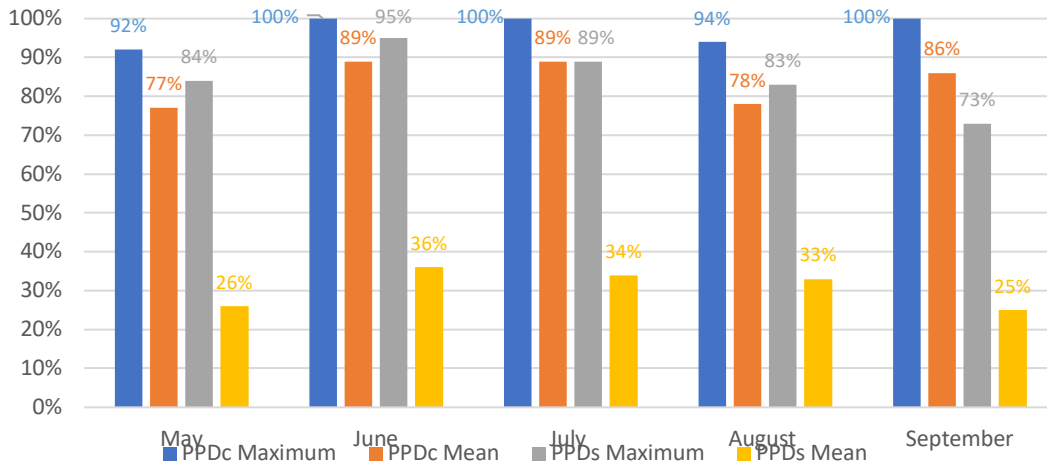
The mean simulated Predicted Mean Vote, The mean calculated Predicted Mean Vote and mean measured Thermal Sensation Vote (TSV) for each day visitors were surveyed is compared in Figure 5 for all the Sunday services analyzed. Sundays were chosen since these days are the time when the church is more populated with almost 200 people attending to service. The average TSV values ranged almost consistently in the neutral area (-1, 0, +1) while average PMVc values remained in the cooler bands (-2, -3). The exception to this is the first two assessed days in September in which TSV values fell into the cooler bands as well reaching -1.8 and -1.3 on September 1 and September 8, respectively. Throughout these two dates, the TSV and PMVc values were more closely related than any other in the studied period. On the other side, PMVs aligns with the TSV values ranging in the warm area of +1, however, during September dates PMVs remains consistent while TSV answers fell into the colder area as explained above.



**Figure 6:** Comparison between TSV, PMVc and PMVs average values daily (service days).

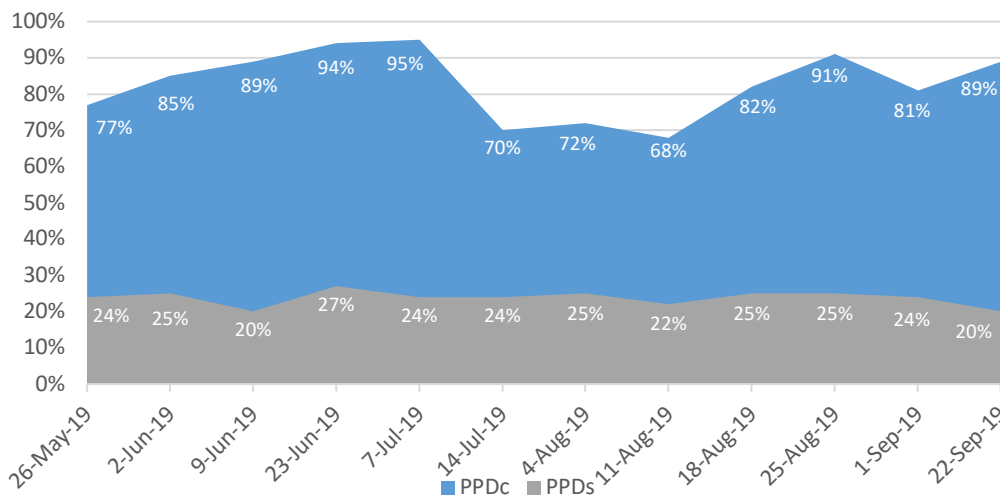
**3.2. Comparison of calculated and simulated Percentage of Predicted Dissatisfaction PPD**

In order to evaluate thermal dissatisfaction of occupants, data from Fanger’s model and simulation results were analyzed. Calculated (PPDc) and simulated (PPDs) dissatisfaction percentages regarding indoor thermal conditions are documented monthly, as shown in Figure 7. PPDc and PPDs maximum values show similar trends with over 75% dissatisfaction level during the selected months. However, PPDc and PPDs mean values have a significant difference of approximate 50%. It is worth mentioning that the PPDs outcomes (between 25% and 35%) are lower than the TSV (between 70% and 90%).



**Figure 7:** Comparison between PPDC and PPDs maximum and mean average values monthly.

Surprisingly, the highest PPDC value was obtained with 100% of dissatisfied visitors in June, July, and September. For the other two months of May and August, the PPDC didn't drop under 92% showing very high values of dissatisfied people using the calculated method. With lower percentages, the simulated thermal dissatisfaction values showed a very similar trend that the calculated results. September was the month when occupants showed the lowest dissatisfaction with 73% maximum value. Although PPDs maximum values were in the range of 73% - 95%, the same profile but lower percentages in the range of 25% - 36% was observed in the PPDs mean values.



**Figure 8:** Comparison between PPDC and PPDs average values daily (service days).

The mean calculated Predicted Percentage of Dissatisfied (PPDC) and the mean simulated Predicted Percentage of Dissatisfied (PPDs) for each day are compared in Figure 8 for all the Sunday services. It was observed that the calculated thermal dissatisfaction rate was in the range of 68% and 95% as the lowest and highest values on August 11 and July 7, respectively. The percentage of dissatisfied occupants for simulation results was not higher than 27% in these analyzed 12 service days. PPDs values never dropped under 20% as it was seen on June 9 and September 22.

**CONCLUSION**

It is significant to determine the conditions of historic buildings as a heritage for future generations. These structures that are still actively used, need to be protected and modified with appropriate interventions such as efficient mechanical systems for humidity and temperature control. While accomplishing this indoor microclimatic stability, user satisfaction is also essential to take into consideration with thermally comfortable indoor environments. The indoor microclimate in this 18<sup>th</sup> century religious building has been affected only by the outdoor climate until the mechanical system was installed in the 1990s. This paper analyzes the user dissatisfaction level in a historic church through three different methodological steps: real, calculated, and simulated data. These results were compared to understand the accuracy of each used method. The monitored indoor environmental conditions during the study period showed that the current

internal parameters did not meet the occupants thermal comfort expectations. The obtained TSV and calculated PMV and PPD values during the cooling season, were compared with the same simulation results of IES-VE software.

The main results of the research are:

- comparison between TSV and PMVc: The indoor temperature generally increases due to the rising occupant density that did not influence the thermal sensation of visitors. Since ambient temperature mainly affects the occupants' thermal sensation, the TSV values stayed within the comfortable range accepted by the ASHRAE 55 (between -0.5 and +0.5). However, average PMVc values remained in the cooler bands (-2, -3) due to the thermal leap. It is found that the comfort sensation calculated by the PMV model was lower than simulated results and real opinion of occupants.
- comparison between TSV and PMVs: The occupants' thermal sensation values acquired from the questionnaire and simulated PMV votes are aligning. Based on this result, accuracy of simulation values on thermal sensation are better than the Fanger's model in a historic building in a hot and humid climate region. Overall PMV model failed to predict thermal comfort in this case during warm days.
- comparison between PPDc and PPDs: The significant difference in results of people dissatisfaction between calculated and simulated data showed us that this evaluation is not accurate enough in predicting the thermal comfort in this building type. Thermal comfort in historic spaces largely depends on the occupant number and characteristics. Results show that average simulated values assume a higher number of people satisfy their thermal environment. On the other hand, calculated data found that each month only less 25% of visitors found the space thermally acceptable. There are two reasons for the result, the relatively low cloth insulation of visitors due to high outdoor temperatures and inefficient humidity control of the HVAC system.

This manuscript proposes that Post-Occupancy Evaluation, through a mixed quantitative and qualitative analysis (including users' feedback), is an essential technique for defining which causes affect occupants' thermal satisfaction, and for understanding the opportunities for performance improvement. While providing a strategy for the upgrading of a building's thermal performance is an important action for securing indoor thermal comfort, the heritage value of the building needs to be taken into account in order to achieve a heritage-sensitive upgrading. Therefore, in order to implement an accurate intervention a mixed method approach is required when evaluating a historic building performance.

## ACKNOWLEDGEMENTS

This research would not have been possible without the co-operation of the Archdiocese of San Antonio, Ford, Powell and Carson Inc., and the valuable contribution of the Mission Concepción de Acuña staff. This research has been supported by the Centre of Cultural Sustainability (CCS) of the University of Texas at San Antonio (UTSA). The authors would like also to acknowledge Kelsey Williamson, Mayra Landin and Molly Padilla for their support in the research.

## REFERENCES

- ASHRAE, Thermal Environmental Conditions for Human Occupancy, ANSI/ASHRAE Standard 55–2013.
- Belpoliti, V., Bizzarri, G., Boarin, P., Calzolari, M. and Davoli, P., A Parametric Method to Assess the Energy Performance of Historical Urban Settlements. Evaluation of the Current Energy Performance and Simulation of Retrofit Strategies for an Italian Case Study, *Journal of Cultural Heritage*, pp. 1–13, accessed November 9, 2017, from <http://dx.doi.org/10.1016/j.culher.2017.08.009>, 2017. DOI: 10.1016/j.culher.2017.08.009
- Fabbri, K., Pretelli, M. and Professor, A., Heritage Buildings and Historic Microclimate without HVAC Technology: Malatestiana Library in Cesena, Italy, UNESCO Memory of the World, *Energy and Buildings*, vol. 76, pp. 15–31, accessed May 23, 2017, from [http://ac.els-cdn.com.ezproxy.auckland.ac.nz/S0378778814001650/1-s2.0-S0378778814001650-main.pdf?\\_tid=4884d0c6-3f46-11e7-9fc9-0000aacb35f&acdnat=1495495857\\_e00537a84117a938c48cf051bebf641c](http://ac.els-cdn.com.ezproxy.auckland.ac.nz/S0378778814001650/1-s2.0-S0378778814001650-main.pdf?_tid=4884d0c6-3f46-11e7-9fc9-0000aacb35f&acdnat=1495495857_e00537a84117a938c48cf051bebf641c), 2014. DOI: 10.1016/j.enbuild.2014.02.051
- Fanger, P. O., Thermal Comfort: Analysis and Applications in Environmental Engineering, McGraw-Hill, 1970.
- Giuli, V. De, Pos, O. Da and Carli, M. De, Indoor Environmental Quality and Pupil Perception in Italian Primary Schools, *Building and Environment*, vol. 56, pp. 335–45, from <http://dx.doi.org/10.1016/j.buildenv.2012.03.024>, 2012. DOI: 10.1016/j.buildenv.2012.03.024
- Integrated Environmental Solutions, <https://www.iesve.com/software/virtual-environment>, 2019.
- Loupa, G., CHARPANTIDOU, E., KIOUTSIOUKIS, I. and RAPSOMANIKIS, S., Indoor Microclimate, Ozone and Nitrogen Oxides in Two Medieval Churches in Cyprus, *Atmospheric Environment*, vol. 40, no. 39, pp. 7457–66, accessed June 5, 2014, from <http://www.sciencedirect.com/science/article/pii/S135223100600731X>, December 2006. DOI: 10.1016/j.atmosenv.2006.07.015
- Martinez-Molina, A. and Alamaniotis, M., Enhancing Historic Building Performance with the Use of Fuzzy Inference System to Control the Electric Cooling System, *Sustainability (Switzerland)*, vol. 12, no. 14, 2020. DOI: 10.3390/su12145848



- Martinez-Molina, A., Boarin, P., Tort-Ausina, I. and Vivancos, J.-L., Assessing Visitors' Thermal Comfort in Historic Museum Buildings: Results from a Post-Occupancy Evaluation on a Case Study, *Building and Environment*, vol. 132C, pp. 291–302, from <http://linkinghub.elsevier.com/retrieve/pii/S0360132318300696>, February 2018. DOI: 10.1016/j.buildenv.2018.02.003
- Martinez-Molina, A., Boarin, P., Tort-Ausina, I. and Vivancos, J.-L., Post-Occupancy Evaluation of a Historic Primary School in Spain: Comparing PMV, TSV and PD for Teachers' and Pupils' Thermal Comfort, *Building and Environment*, vol. 117, pp. 248–59, from <http://linkinghub.elsevier.com/retrieve/pii/S0360132317300963>, May 2017. DOI: 10.1016/j.buildenv.2017.03.010
- Martínez-Molina, A., Tort-Ausina, I., Cho, S. and Vivancos, J.-L., Energy Efficiency and Thermal Comfort in Historic Buildings: A Review, *Renewable and Sustainable Energy Reviews*, vol. 61, pp. 70–85, from <http://linkinghub.elsevier.com/retrieve/pii/S1364032116002537>, 2016. DOI: 10.1016/j.rser.2016.03.018
- Martins, A. M. T. and Carlos, J. S., The Retrofitting of the Bernardas' Convent in Lisbon, *Energy and Buildings*, vol. 68, pp. 396–402, accessed June 4, 2014, from <http://www.sciencedirect.com/science/article/pii/S0378778813006129>, January 2014. DOI: 10.1016/j.enbuild.2013.07.087
- Mors, S. ter, Hensen, J. L. M., Loomans, M. G. L. C. and Boerstra, A. C., Adaptive Thermal Comfort in Primary School Classrooms: Creating and Validating PMV-Based Comfort Charts, *Building and Environment*, vol. 46, no. 12, pp. 2454–61, 2011. DOI: 10.1016/j.buildenv.2011.05.025
- Teli, D., Jentsch, M. F. and James, P. a B., Naturally Ventilated Classrooms: An Assessment of Existing Comfort Models for Predicting the Thermal Sensation and Preference of Primary School Children, *Energy and Buildings*, vol. 53, pp. 166–82, from <http://dx.doi.org/10.1016/j.enbuild.2012.06.022>, 2012. DOI: 10.1016/j.enbuild.2012.06.022
- Varas-Muriel, M. J., Martínez-Garrido, M. I. and Fort, R., Monitoring the Thermal–Hygrometric Conditions Induced by Traditional Heating Systems in a Historic Spanish Church (12th–16th C), *Energy and Buildings*, vol. 75, pp. 119–32, accessed May 27, 2014, from <http://www.sciencedirect.com/science/article/pii/S0378778814001108>, June 2014. DOI: 10.1016/j.enbuild.2014.01.049
- Zivkovic, V. and Džikić, V., Return to Basics—Environmental Management for Museum Collections and Historic Houses, *Energy & Buildings*, vol. 95, pp. 116–23, accessed May 12, 2017, from [http://ac.els-cdn.com/S0378778814009542/1-s2.0-S0378778814009542-main.pdf?\\_tid=bdbd4fea-36c6-11e7-92d6-00000aab0f01&acdnat=1494561467\\_b70149814a5a66c74459f9dc744021fe](http://ac.els-cdn.com/S0378778814009542/1-s2.0-S0378778814009542-main.pdf?_tid=bdbd4fea-36c6-11e7-92d6-00000aab0f01&acdnat=1494561467_b70149814a5a66c74459f9dc744021fe), 2015. DOI: 10.1016/j.enbuild.2014.11.023

# Impacts of Buildings' Energy Data Adjustment on CBECS-benchmarking Evaluations

Mahsa Farid Mohajer<sup>1</sup>, Ajla Aksamija<sup>1</sup>

<sup>1</sup>University of Massachusetts, Amherst, MA

**ABSTRACT:** To evaluate buildings' energy performance, one predominant approach is by benchmarking their annual energy usage against the representative baseline peers. In this study, six buildings from various categories, all located at the University of Massachusetts Amherst, were used as case study buildings. The principal building activities included education, food service, health services (outpatient), lodging, office, and public assembly. To benchmark energy data of the case study buildings against CBECS baselines, first, monthly energy data (i.e., steam and electricity) of the case study buildings from 2016 to 2018 was collected. The raw energy data was then adjusted, using weather-normalization and/or three-year average, depending on the applicability of each method. The adjusted energy data was used to calculate case study buildings' energy usage intensities (EUIs), which resulted in three potential EUIs for each case study building (i.e., weather-normalized, average, and/or adjusted EUIs). The case study buildings' EUIs were then used for CBECS benchmarking evaluation. It was found that the raw energy data adjustment methods had a significant impact on benchmarking results. For instance, for the health services case study building, deviation of the weather-normalized EUI from the base EUI was -18%, while the average-EUI deviation was 11%, indicating a significant energy performance difference. Additionally, for the lodging and public assembly building typologies, the adjusted-EUI deviations were, respectively, 13% and -5%. Whereas, the average-EUI deviations were 54% and 8%. Moreover, separate energy intensity benchmarkings (i.e., electricity vs. gas intensities) determined that for the case study buildings with positive EUI-deviation, a specific type of energy (electricity vs. gas) results in a more significant increase in EUI. This is specifically helpful in prioritizing potential future retrofitting considerations, with the objective to identify the most strategic and effective energy-efficiency measures.

**KEYWORDS:** CBECS, energy usage intensity, weather normalization, energy benchmarking, energy consumption

## INTRODUCTION

There are two categories of energy data sets for the U.S. commercial buildings: surveys and simulation-based (Ye et al. 2019). The former data set is based on the data collected by surveying building respondents, energy providers, building meters, and/or utility bills (Ye et al. 2019). The latter data set is generated based on the results of building energy simulation programs, where model developers collect model inputs from survey data, expert knowledge, and energy standards to run the simulations (Crawley et al. 2008; Ye et al. 2019). Survey data are divided into national and local data sets, such as Commercial Buildings Energy Consumption Survey (CBECS), California Commercial End-Use Survey (CEUS), and Building Performance Database (BPD) (Berger et al. 2016; LBNL 2014; EIA 2015). CBECS is a national, comprehensive, and in-depth data source of U.S. commercial buildings' energy usage and building characteristics, such as geometry, schedules, and end-use energy usage (EIA 2015). CEUS is an in-depth local data source of California's commercial buildings' energy data (CEC 2006). BPD does not contain in-depth information about individual building's characteristics and energy data. Rather, it is one of the largest national data sets, with a large-scale building sample, which contains several key building characteristics and energy data (Berger et al. 2016; LBNL 2014).

In the built environment, data sets are used to assess energy performance of buildings through benchmarking. For most of building types, reference data can be extracted from CBECS database, which is the data source used in this study. CBECS defines commercial buildings as properties that are larger than 93 m<sup>2</sup> (1000 ft<sup>2</sup>), whose principal activities do not include residential, agricultural, and industrial functions. Therefore, CBECS database includes information about commercial office buildings, but also educational, healthcare, retail, public assembly, and religious facilities.

For benchmarking purposes, one critical step is the analysis and adjustment of raw energy data that results in more reliable benchmarks, used for depiction of buildings' energy performance. One of the most common methods for energy data adjustment is weather-normalization. In this approach, regression of energy vs. degree-days is plotted to quantify the effects of outside temperature on buildings' energy use. However, this method solely considers dry-bulb temperature, while it ignores other climate variables (Eto 1988). Moreover, depending on buildings' internal loads, impact of outside temperature can be less influential. In this study an imperative existed to separately investigate applicability of weather-normalization method for each case study building. If weather-normalization was not

appropriate in some cases, another method that was used to remove the impact of one specific year's weather condition on energy data was averaging multiple years' energy data. The outcomes of the two approaches, with their significance on benchmarking evaluations, prove the vital impact of data adjustment methods.

## 1.0 LITERATURE REVIEW

Two energy benchmarking methods of top-down and bottom-up were comparatively evaluated in a study (Hong et al. 2013). The top-down method referred to deriving benchmarks based on building-level energy performance evaluation, expressed as EUI. In the U.S. there are top-down approaches used with complex models, such as multiple regression to identify buildings' energy use determinants (Monts and Blissett 1982). On the other hand, in the bottom-up approach, whole building energy benchmark (expressed as EUI) is calculated based on the aggregated energy performance of the individual systems, like ventilation system (Hong et al. 2013). Electricity use in office buildings was benchmarked against CBECS database in another study (Sharp 1995). In this study, step-wise linear regressions were used to identify determinants of EUIs in office buildings, using several CBECS variables and building characteristics. Results were used to develop models for energy use estimation. It was found that beyond floor-area, other factors (such as the number of workers and personal computers, occupancy schedule, operating hours, and the presence of an economizer or chiller) have significant impacts on energy performance indicators (Sharp 1995).

In another study, variations in weather and occupancy of individual buildings were identified as factors that improved level of comparability between individual buildings and their baseline counterparts (CIBSE 2009). Benchmarking comparability improvements were further investigated, where the impacts of building characteristics on the pattern of energy performance of schools were evaluated (Hong et al. 2014). In the U.S., cities with mandated building energy benchmarking are required to use the Environmental Protection Agency's Energy Star Portfolio Manager (Mims et al. 2017). However, since Energy Star's models are based on the national database (CBECS), its capability to capture local conditions (e.g., weather, building codes, and urban heat island effect) is limited (Roth et al. 2020). Due to the limitations of Energy Star, building energy benchmarks in cities were investigated, examining the feasibility of using city-specific public data sources (Roth et al. 2020). Results of the analysis were then compared to CBECS-based benchmarks. It was shown that building characteristic information, such as building area, property type, conditioned area, and water usage were the most critical ones to collect and use in benchmarking (Roth et al. 2020).

## 2.0. RESEARCH OBJECTIVES AND METHODS

For the purpose of this study, several existing buildings, located at the University of Massachusetts Amherst (UMass Amherst), were used as case studies. The case study buildings included six principal building activities: education, food service, health care (outpatient), lodging, office, and public assembly buildings, aiming to represent all institutional building categories/activities available through CBECS data sources. Research objectives were (i) to evaluate the impacts of the two methods for energy data adjustment (i.e., weather-normalization or averaging) on the analysis of CBECS-benchmarking outcomes and (ii) to develop a guideline on how to evaluate Energy Usage Intensity (EUI) benchmarks of the case study buildings by separately investigating their electricity and gas intensities. This study was carried out using the following steps. Initially, the actual energy data (i.e., monthly steam and electricity consumption) was collected from 2016 to 2018. Next, energy data was adjusted, using the two methodologies of weather-normalization and/or averaging. Once raw data was adjusted, energy usage intensities (including gas, electricity, and total use) of each case study building were compared against their corresponding value on CBECS database. Lastly, the impacts of each data adjustment methodology on benchmarks were evaluated.

### 2.1. Case study buildings introduction

The principal building activities within the CBECS database were considered, and the case study buildings were divided into six categories: academic (for educational activities), dining hall (food service), health services (health care), residential (lodging), administrative (office), and recreational (public assembly) buildings. For the academic building category, Marcus Hall, which was built in 1966 and has an area of 5,873 m<sup>2</sup> (63215 f<sup>2</sup>), was selected. It includes dry lab spaces, classrooms, meeting rooms, and office spaces. In the dining hall category, Berkshire Dinning Commons, built in 1968 and with an area of 4,520 m<sup>2</sup> (48658 f<sup>2</sup>), was selected. The University Health Services, which was built in 1973 and has an area of 5,435 m<sup>2</sup> (58506 f<sup>2</sup>), was selected for the health services category. Moore House that was built in 1968 and has an area of 5,418 m<sup>2</sup> (58319 f<sup>2</sup>), was selected as the residential case study building. Goodell Building, which was built in 1960 and has an area of 12,055 m<sup>2</sup> (129765 f<sup>2</sup>), was the selected administrative case study building. It includes office spaces, meeting rooms, and some dry lab spaces. And lastly, Recreation Center, built in 2009 and with an area of 14,882 m<sup>2</sup> (160191 f<sup>2</sup>), was selected for the recreational building category. In Fig. 1, the selected case study buildings are illustrated.



Marcus Hall



Berkshire Dining Commons



University Health Services



Moore House



Goodell Building



Recreation Center

**Figure 1:** Selected case study buildings, located at the University of Massachusetts Amherst (UMass Amherst).

## 2.2. Energy data collection

For the selected case study buildings, monthly energy data (i.e., electricity and steam use) was collected, over the three successive years of 2016 to 2018 (Scholarworks UMass Amherst n.d.). At UMass Amherst, steam is generated by the Central Heating Plant (CHP) and is delivered to campus buildings for heating and hot water provision. To compare steam data with CBECS gas database, given the 77% efficiency of the CHP's boilers, central steam use was converted to local gas consumption, by adding 23% to the total energy use.

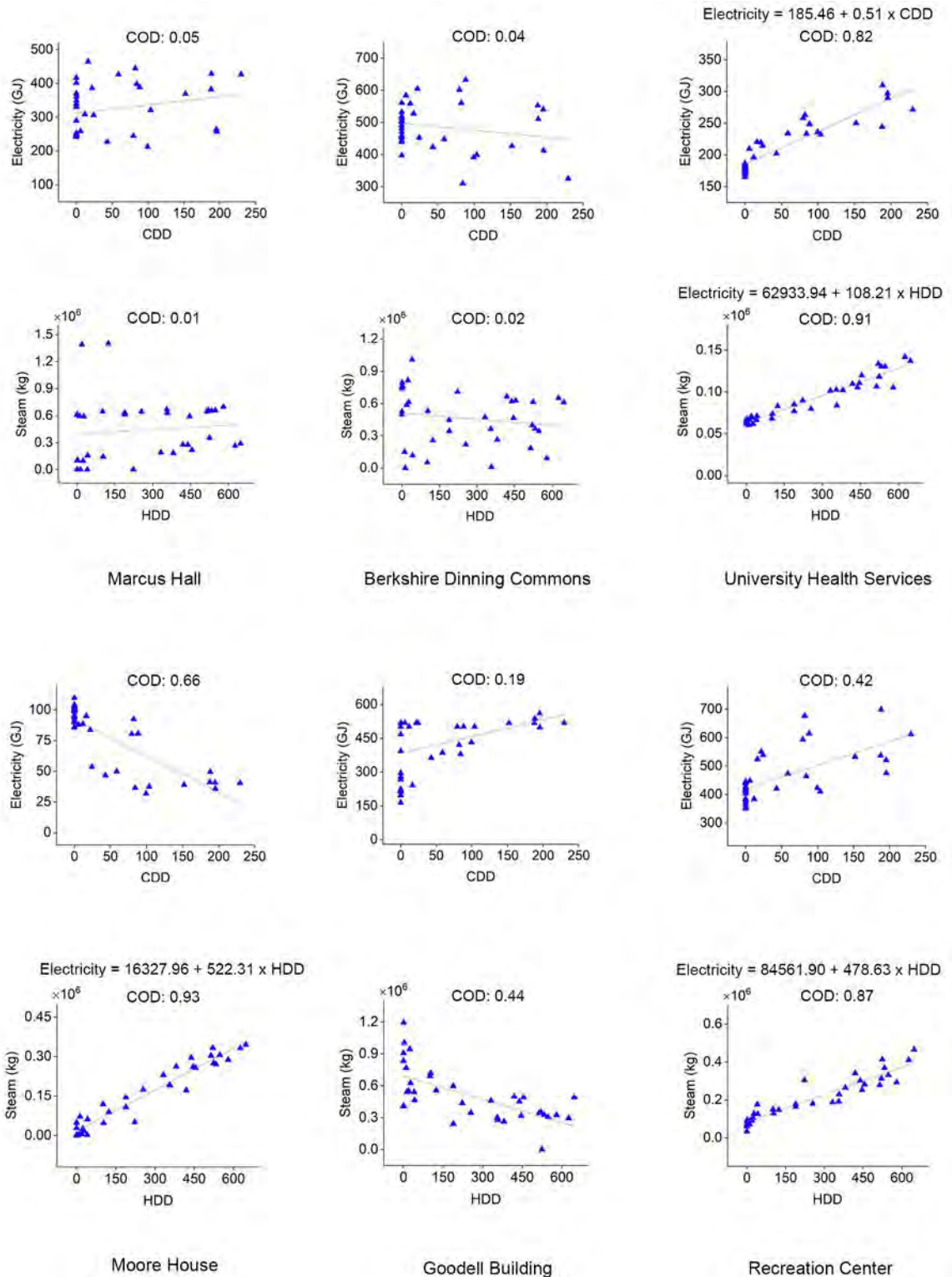
## 2.3. Adjustment of energy data

To compare the actual energy data against CBECS baselines, first, the raw energy data was adjusted so that it was representative of the actual condition and not affected by a specific year's weather condition. To do so, two methods for adjusting energy data (i.e., weather-normalization and three-year averaging) were used, given their applicability for each of the case study buildings. Adjustment methodologies are discussed in detail in the following sections.

## 3.0. RESULTS AND ANALYSIS

### 3.1. Linear regression analysis

The impacts of weather conditions on the energy data, specifically the outside dry bulb temperature, were investigated using regression of monthly energy data (i.e., electricity or steam) on the monthly degree-days (i.e., heating or cooling degree-days). This is shown in Fig. 2. To calculate monthly HDDs/CDDs, first, the average outside daily temperatures were calculated, using the lowest and the highest daily outside temperatures, provided by UMass Computer Science Weather Station (UMass Amherst Computer Science n.d.). Next, daily HDDs/CDDs were computed by calculating the difference of the average temperature from the base temperature of 18.33°C (65°F), which were then summed up to calculate the monthly HDDs/CDDs of the three successive years (2016 to 2018).



**Figure 2:** Case study buildings' energy vs. degree-days regressions.

For case study buildings where linear regression was the surrogate for all impacts, climatic or otherwise, on energy consumption, a satisfying coefficient of determination (COD) was considered to be equal to or higher than 0.73 (Lee 2008). Here, weather-normalization was used for adjusting the energy data.



### 3.2. Weather-normalization of energy data

For the case study buildings that showed a satisfying COD in their regression scatter plot, weather-normalization was implemented on energy data for the year 2018. Weather-normalization model that correlated monthly energy consumption with monthly degree-days is shown in Equation 1, where “a” was non-weather-sensitive component (i.e., hot water, lighting, ventilation, cooking, refrigeration, equipment, and/or computing), “b” was weather-driven component (heating or cooling load), and “x” was regression coefficient (HDD or CDD) (Makhmalbaf, Srivastava, and Wang 2013).

$$\text{Monthly energy use} = a + bx \tag{1}$$

First, the Typical Metered Year’s (TMY<sub>3</sub>) H/CDDs of the closest weather station, located in Chicopee, was collected (EnergyPlus 2020). In order to keep consistency between H/CDDs (with the base temperature of 18.33°C/65°F) and the TMY<sub>3</sub>’s DDs (with the base temperature of 18°C/64.4°F), the latter were converted to H/CDDs with the base temperature of 18.33°C, by adding 0.6 DDs to daily DDs of each month to calculate the monthly H/CDDs, as shown in Table 1.

**Table 1:** TMY<sub>3</sub>’s monthly H/CDDs, with base temperature of 18°C and 18.33°C.

	TMY <sub>3</sub> ’s HDD (Base T: 18°C)	TMY <sub>3</sub> ’s CDD (Base T: 18°C)	Number of days (2018)	TMY <sub>3</sub> ’s HDD (Base T: 18.33°C)	TMY <sub>3</sub> ’s CDD (Base T: 18.33°C)
Jan.	569	0	31	587.6	18.6
Feb.	536	0	28	552.8	16.8
Mar.	495	0	31	513.6	18.6
Apr.	323	0	30	341	18
May	159	9	31	177.6	27.6
Jun.	33	54	30	51	72
Jul.	2	132	31	20.6	150.6
Aug.	13	81	31	31.6	99.6
Sep.	103	29	30	121	47
Oct.	220	5	31	238.6	23.6
Nov.	385	0	30	403	18
Dec.	512	0	31	530.6	18.6

TMY<sub>3</sub>’s DDs removed the effect of one specific year’s weather condition on the case study building’s energy data. Considering that the non/weather-sensitive values were obtained from the regression analyses, by inserting the TMY<sub>3</sub>’s DDs in Equation 1, weather-normalized energy data (i.e., gas or electricity) of each case study building was calculated.

### 3.3. Average of energy data

For the case study buildings where weather-normalization was not an applicable method for energy data adjustment, average energy data of the three successive years (2016 to 2018) was used. The reason for using average data was to prevent potential unpredicted weather circumstances or metering errors of a specific year to impact energy data, as the meters may infrequently go off or become inaccurate. The weather-normalized and/or average monthly energy data of the case study buildings are shown in Table 2.

**Table 2:** Weather-normalized and average energy data of the case study buildings.

Case study building	Annual electricity use (GJ)		Annual gas use (GJ)	
	W-N	Ave.	W-N	Ave.
Marcus Hall	N/A	3893.72	N/A	17855.30
Berkshire Dinning Commons	N/A	5833.09	N/A	18979.36
University Health Services	2378.13	2547.66	2228.80	3694.46
Moore House	N/A	921	4207.92	6047.03
Goodell Building	N/A	5069.69	N/A	20799.80
Recreation Center	N/A	5569.03	6709.70	8395.03

### 3.4 CBECS baselines and benchmarking evaluations

To benchmark energy intensities of the case study buildings, depending on the buildings’ typology, their electricity and gas intensities were compared against 2012 CBECS’s energy intensities, as shown in Table 3 and 4 (EIA 2015). The reason for collecting 2012 CBECS data was the fact that this data collection period was the last survey information released by the Energy Information Administration (EIA). The next data collection period was 2018, but EIA has not released it yet.

**Table 3:** 2012 CBECS electricity intensity of buildings with various principal activities. Source: (EIA 2015)

Principal building activity	Electricity intensity (GJ/m <sup>2</sup> /y)							
	Total elec. intensity	Cool.	Vent.	Ligh.	Cook.	Refr.	Equi.	Comp.
Education	0.32	0.09	0.06	0.07	N/A	N/A	0.02	0.07
Food services	1.91	0.20	0.19	0.12	0.61	0.71	0.05	0.03
Health care (Outpatient)	0.55	0.07	0.23	0.13	N/A	N/A	0.03	0.08
Lodging	0.37	0.08	N/A	0.08	0.05	0.06	0.08	0.01
Office	0.49	0.09	0.15	0.10	N/A	N/A	0.03	0.12
Public assembly	0.45	0.20	0.05	0.07	0.02	0.06	0.02	0.03

**Table 4:** 2012 CBECS gas intensity of buildings with various principal activities. Source: (EIA 2015)

Principal building activity	Gas intensity (GJ/m <sup>2</sup> /y)		
	Total gas intensity	Space heating	Water heating
Education	0.38	0.30	0.08
Food services	0.83	0.38	0.44
Health care (Outpatient)	0.49	0.44	0.04
Lodging	0.46	0.16	0.30
Office	0.29	0.05	0.34
Public assembly	0.42	0.40	0.02

For each case study building, the most appropriate method for actual data adjustment was used to quantify and compare electricity and gas intensities against the baseline data. As shown in Table 5, average energy intensities were calculated for all case study buildings. However, for the ones that weather-normalization was an applicable method for data adjustment (i.e., University Health Services), the latter approach was taken into account, as it provided the most accurate results. For two case study buildings (i.e., Moore House and Recreation Center) average method was used for electricity intensity and weather-normalization was utilized for gas intensity calculations. For these cases, EUI was adjusted by summing up the average electricity and the weather-normalized gas intensities, as illustrated in Table 5.

**Table 5:** Weather-normalized vs. average electricity, gas, and energy usage intensities.

Case study building	Electricity intensity (GJ/m <sup>2</sup> /y)		Gas intensity (GJ/m <sup>2</sup> /y)		WN EUI (GJ/m <sup>2</sup> /y)	Ave. EUI (GJ/m <sup>2</sup> /y)	Adj. EUI (GJ/m <sup>2</sup> /y)
	W-N	Ave.	W-N	Ave.			
Marcus Hall	N/A	0.66	N/A	3.04	N/A	3.70	N/A
Berkshire Dinning Commons	N/A	1.29	N/A	4.20	N/A	5.49	N/A
University Health Services	<b>0.44</b>	0.47	<b>0.41</b>	0.68	<b>0.85</b>	1.15	N/A
Moore House	N/A	<b>0.17</b>	<b>0.78</b>	1.12	N/A	1.29	<b>0.95</b>
Goodell Building	N/A	0.42	N/A	1.73	N/A	2.15	N/A
Recreation Center	N/A	<b>0.37</b>	<b>0.45</b>	0.56	N/A	0.94	<b>0.83</b>

EUI of the case study buildings was then compared against CBECS baseline, capturing each case study building's EUI deviation. As shown in Table 6, raw data adjustment methods had a significant impact on benchmarking evaluations. For instance, in the University Health Services case study, weather-normalized-EUI deviation from the baseline was -18.20%, whereas the average-EUI deviation was 10.83%. The average-EUI deviation of Moore House was 53.59%, while its adjusted-EUI deviations was 13.06%. Additionally, Recreation Center had -5.30% of adjusted-EUI deviation, whereas its average-EUI deviation was 7.70%. Results indicated that weather-normalized- and adjusted-EUIs deviations were lower than their corresponding average-EUI deviations.

**Table 6:** EUI-deviations from the CBECS baselines.

Case study building	CBECS EUI (GJ/m <sup>2</sup> /y)	EUI deviation from the CBECS baseline		
		WN EUI (GJ/m <sup>2</sup> /y)	Ave. EUI (GJ/m <sup>2</sup> /y)	Adj. EUI (GJ/m <sup>2</sup> /y)
Marcus Hall	0.70	N/A	426.90%	N/A
Berkshire Dinning Commons	2.74	N/A	100.64%	N/A
University Health Services	1.04	<b>-18.20%</b>	10.83%	N/A
Moore House	0.84	N/A	53.59%	<b>13.06%</b>
Goodell Building	0.83	N/A	158.37%	N/A
Recreation Center	0.87	N/A	7.70%	<b>-5.30%</b>



In addition to quantifying EUI deviations, case study buildings' electricity and gas intensities were compared against the baseline data. In Table 7, weather-normalized and average electricity and gas intensities and their deviation from CBECS data are shown.

**Table 7:** Electricity and gas intensities deviation from the CBECS baselines.

Case study building	Electricity intensity (GJ/m <sup>2</sup> /y)		Gas intensity (GJ/m <sup>2</sup> /y)		Electricity and gas intensities deviations from the baseline			
	W-N	Ave.	W-N	Ave.	W-N elec.	Ave. elec.	W-N gas	Ave. gas
Marcus Hall	N/A	0.66	N/A	3.04	N/A	105.87%	N/A	698.38%
Berkshire Dinning Commons	N/A	1.29	N/A	4.20	N/A	-32.39%	N/A	407.59%
University Health Services	<b>0.44</b>	0.47	<b>0.41</b>	0.68	<b>-20.49%</b>	-14.83%	<b>-15.61%</b>	39.89%
Moore House	N/A	0.17	<b>0.78</b>	1.12	N/A	54.55%	<b>67.64%</b>	140.90%
Goodell Building	N/A	0.42	N/A	1.73	N/A	-13.45%	N/A	400.61%
Recreation Center	N/A	0.37	<b>0.45</b>	0.56	N/A	-16.58%	<b>6.68%</b>	33.48%

The purpose of break down EUIs into electricity and gas intensities was (i) to quantify how energy performance, specifically gas intensity, of the case study buildings could vary depending on the implemented data adjustment method and (ii) to capture the impact of each source of energy (i.e., electricity vs. gas) on the overall energy performance of the case study buildings. As shown in Table 7, in all the cases, gas usage was the most influential factor for the EUI deviation, due to its higher and positive deviation from CBECS baselines.

Additionally, for the case study buildings that gas data was weather-normalized, average gas intensity showed a higher deviation from the baseline. For instance, while in the health service category (i.e., University Health Services building) the average gas intensity was 39.89% deviated, but the weather-normalized gas intensity had -15.61% deviation, proving the significant energy performance difference. In the lodging category (i.e., Moore House), even though the average gas intensity was 140.90% deviated, the weather-normalized gas intensity had a 67.64% deviation. Lastly, in the case of public assembly activity (i.e., Recreation Center building) average gas intensity showed 33.48% deviation, but weather-normalized gas intensity indicated 6.68% deviation.

## CONCLUSION

This study found that buildings' EUI is significantly influenced by the data analysis methods, making it a critical factor in CBECS benchmarking evaluations. The first crucial step to enable reliable energy data analysis is to divide energy information based on the sources of energy (e.g., gas vs. electricity). Division of the energy data will benefit benchmarking evaluation in two different ways: (i) determining whether regression analysis of energy vs. degree-days is an applicable method on case-by-case basis and (ii) depicting which energy sector has the most dominance on the overall energy performance of the case study buildings.

The former (i.e., evaluation of regression analysis applicability) determines what data analysis method results in the most precise benchmarking evaluation. For buildings where monthly energy use does not show a strong correlation with monthly degree-days, averaging energy data should be adopted as a reliable analysis approach. On the other hand, if one source of energy (e.g., gas or electricity) indicates a strong regression correlation with the degree-days, while the other does not, the adjusted EUI (i.e., weather-normalized EUI of the first and average EUI of the second source of energy) should be taken into consideration.

The latter benefit (i.e., determining the most influential energy source on building energy performance) depicts which energy sector had the most dominance on the building overall energy performance by dividing EUIs into two subcategories of electricity and gas intensities. Data breakdown is specifically useful in identifying and deciding on the retrofitting measures. As such, decisions about whether to focus building improvement and retrofitting on reduction of electricity or gas can shift direction, depending on the EUI's breakdown data. For the investigated case study buildings, which are located in a heating-dominated climate, reduction of gas use (by improving boiler's efficiency and/or decreasing envelope's heat losses through the reduction of window to wall ratio, etc.) is prioritized over electricity use reduction (by changing lighting fixtures and/or improving building envelope's thermal resistance to reduce cooling loads).

Next step of this research is to identify strong determinants of energy use in the case study buildings that did not indicate a significant relation with the outside dry-bulb temperature. Considering the significant factors, the raw energy data of 2018 will then be normalized and energy performance benchmarks will be compared to the average data. The outcomes of the research will be used to develop building-specific methods for actual data adjustment and accurate energy performance indicator, which will eventually result in more robust and reliable benchmarking evaluations.

## REFERENCES

- Berger, Michael A., Paul A. Mathew, and Walter Travis. 2016. "Big Data Analytics in the Building Industry." *ASHRAE Journal* 58 (7). <https://buildings.lbl.gov/publications/big-data-analytics-building-industry>.
- California Energy Commission (CEC). 2006. "California Commercial End-Use Survey."
- Chartered Institution of Building Services Engineers (CIBSE). 2009. *CIBSE TM47 Operational Ratings and Display Energy Certificates*. London: CIBSE.
- Crawley, Drury B., Jon W. Hand, Michael Kummert, and Brent T. Griffith. 2008. "Contrasting the Capabilities of Building Energy Performance Simulation Programs." *Building and Environment* 43 (4): 661–73. <https://doi.org/10.1016/j.buildenv.2006.10.027>.
- EnergyPlus. 2020. "Weather Data." 2020. <https://www.energyplus.net/weather>.
- Eto, Joseph H. 1988. "On Using Degree-Days to Account for the Effects of Weather on Annual Energy Use in Office Buildings." *Energy and Buildings* 12 (2): 113–27. [https://doi.org/10.1016/0378-7788\(88\)90073-4](https://doi.org/10.1016/0378-7788(88)90073-4).
- Hong, Sung-Min, Greig Paterson, Esfandiar Burman, Philip Steadman, and Dejan Mumovic. 2013. "A Comparative Study of Benchmarking Approaches for Non-Domestic Buildings: Part 1 – Top-down Approach." *International Journal of Sustainable Built Environment* 2 (2): 119–30. <https://doi.org/10.1016/j.ijbsbe.2014.04.001>.
- Hong, Sung-Min, Greig Paterson, Dejan Mumovic, and Philip Steadman. 2014. "Improved Benchmarking Comparability for Energy Consumption in Schools." *Building Research and Information* 42 (1): 47–61. <https://doi.org/10.1080/09613218.2013.814746>.
- Lawrence Berkeley National Laboratory (LBNL). 2014. "DOE Buildings Performance Database." 2014. <https://www.energy.gov/eere/buildings/building-performance-database-bpd>.
- Lee, Wen-Shing. 2008. "Benchmarking the Energy Efficiency of Government Buildings with Data Envelopment Analysis." *Energy and Buildings* 40 (5): 891–95. <https://doi.org/10.1016/j.enbuild.2007.07.001>.
- Makhmalbaf, Atefe, Viraj Srivastava, and Na Wang. 2013. "Simulation-Based Weather Normalization Approach to Study the Impact of Weather on Energy Use of Buildings in the U.S." In *13th Conference of the International Building Performance Simulation Association*, 1436–44.
- Mims, Natalie, Steven R. Schiller, Elizabeth Stuart, Lisa Schwartz, Chris Kramer, and Richard Faesy. 2017. "Evaluation of U.S. Building Energy Benchmarking and Transparency Programs: Attributes, Impacts, and Best Practices." *LBNL*. <https://escholarship.org/uc/item/3170j728>.
- Monts, James K., and Marlan Blissett. 1982. "Assessing Energy Efficiency and Energy Conservation Potential Among Commercial Buildings: A Statistical Approach." *Energy* 7 (10): 861–69.
- Roth, Jonathan, Benjamin Lim, Rishree K. Jain, and Dian Grueneich. 2020. "Examining the Feasibility of Using Open Data to Benchmark Building Energy Usage in Cities: A Data Science and Policy Perspective." *Energy Policy* 139 (January): 111327. <https://doi.org/10.1016/j.enpol.2020.111327>.
- Scholarworks UMass Amherst. n.d. "Sustainable UMASS: Campus Data." Accessed May 10, 2020. [https://scholarworks.umass.edu/sustainableumass\\_data/](https://scholarworks.umass.edu/sustainableumass_data/).
- Sharp, Terry. 1995. "Energy Benchmarking in Commercial Office Buildings." In *Proceedings of the ACEEE Summer Study on Energy Efficiency in Buildings*, 7996:321–29. <http://scholar.google.com/scholar?hl=en&btnG=Search&q=intitle:Energy+Benchmarking+In+Commercial+Office+Buildings#0>.
- U.S. Energy Information Administration (EIA). 2015. "Commercial Buildings Energy Consumption Survey (CBECS): Consumption and Expenditures." 2015. <https://www.eia.gov/consumption/commercial/data/2012/index.php?view=consumption>.
- UMass Amherst Computer Science. n.d. "MONTHLY CLIMATOLOGICAL SUMMARY." Accessed May 10, 2020. <http://weather.cs.umass.edu/tabular.html?report=NOAA/NOAA-2019-01.txt>.
- Ye, Yunyang, Wangda Zuo, and Gang Wang. 2019. "A Comprehensive Review of Energy-Related Data for U.S. Commercial Buildings." *Energy and Buildings* 186: 126–37. <https://doi.org/10.1016/j.enbuild.2019.01.020>.

# Push and Pull of Policy: Qualified Allocation Plans and the Design of Subsidized Dwellings

Christina Bollo<sup>1</sup>

<sup>1</sup>University of Illinois Urbana-Champaign, Urbana, IL

**ABSTRACT:** This archival research project inventories the organizational performance of state-level housing agencies in dictating the dwelling-design decisions of affordable housing architects. The design regulations for Low Income Housing Tax Credit financed apartments are not uniform across the country; each state agency allocates the credits to projects through policies set in Qualified Allocation Plans (QAPs), which are crafted through local stakeholder and political input. This is the first quantitative research project investigating the design direction from QAPs for tax credit financed housing in the US. The data for this study are the 50 QAPs and 20 related Design and Construction Standard documents published most recently. The research method is a conceptual content analysis of the design directives and an inventory of the guidance found in the policy instruments. Results show that more than half of the states provide direction at the scale of the dwelling including guidance on minimum, maximum, and target dwellings sizes and bathroom ratios. Slightly less than half the states include guidance at the room scale and unit layout, including minimum dimensions for bedrooms and living rooms; proportional direction on kitchen and dining room arrangements; and both quantitative and qualitative direction on furnishings. This inventory provides a foundation for future qualitative studies in this research area.

**KEYWORDS:** Housing Design, Housing Policy, Low Income Housing Tax Credits, Content Analysis

## INTRODUCTION

The Low-Income Housing Tax Credit (LIHTC) provides partial funding for approximately 100,000 affordable rental units in the United States each year. The design regulations for these apartments are not uniform across the country, however. Each state agency allocates the credits to projects through policies set in Qualified Allocation Plans (QAPs), which are crafted through local stakeholder and political input. Each QAP is unique and is the primary mechanism to incentivize and/or enforce design and development priorities. This archival research project evaluates the organizational performance of state-level housing agencies in dictating the design decisions of affordable housing architects. Understanding how and to what degree state housing agencies stipulate the design of affordable housing is the critical first step of revealing the status of the field, across the country, regarding dwelling design guidance within the QAPs

Section 42 of the Internal Revenue Service (IRS) code details the steps that each state must take in setting its priorities to create or rehabilitate housing units affordable to families with incomes less than 60% of the area median. The IRS directs each state to create a QAP to explicate the state's priorities and expectations and to revise it annually. The QAP governs both the non-competitive and competitive tax credit allocations through requirements and optional points that can help to make an application more competitive. The priorities from the QAPs that are germane to this study's examination of the influences on dwelling size are "project characteristics" and "tenant populations of individuals with children." In addition to the QAP, twenty states also publish – as an addendum, appendix, or separate document – Design and Construction Standards (DCS), with more detailed guidance.

Recent scholarly work analysing Qualified Allocation Plans focuses on the impact of project siting and location incentives, including access to jobs and transit (Lens 2014) and resultant racial segregation (Robinson 2019, Horn and O'Regan 2011); resident health (Shi et al 2020, Ports et al 2018); and green building and environmental sustainability practices (Fuhry and Wells 2013). The most recent inventory of QAPs that surveyed the building characteristic regulations was prepared by the Urban Land Institute (ULI) for the US Department of Housing and Development HUD in 2002 (Gustafson and Walker). The ULI/HUD study (2002) found that those states with building characteristic preferences –such as unit size and number of units in the building – moved from vague preferences in 1990 to more precise requirements in 2001. This paper provides a closer look at the apartment characteristics required and incentivized by the QAPs.

This paper investigates two scales of dwelling-specific design directives present in the policy instruments. At the dwelling scale, this is manifest in minimum, maximum, and/or target unit sizes for a given unit type. At the room scale, this is manifest in room size requirements, such as minimum floor area or minimum dimensions. At the intersection of unit size and room size are requirements related to creating proportional space distribution. In this paper, the term

“dwelling type” or “unit type” is defined by the number of bedrooms the dwelling has. The term “dwelling size” or “unit size” is defined as the net floor area, reported in square feet or in linear dimensions.

This paper presents findings related to the dwelling design direction across scales. The analysis reveals a broad assortment of subjective and objective criteria, with an architect’s signature all that is required for some of the most subjective preferences. There are three clearly defined groups of states: those with high levels of precise and explicit direction at both scales; those with limited guidance at the room scale, but explicit direction for unit size; and those with no dwelling-design guidance. The final section of the paper discusses specific recommendations for each distinct group to further enhance the dwelling design guidance given to architects and developers of buildings financed with Low-Income Housing Tax Credits (LIHTC).

## 1.0 METHOD

The primary method for this study is conceptual content analysis (Krippendorf 1980). The goal of the study is to identify the intentional design guidance of the LIHTC-allocating bodies across the United States. The coding focuses on implicit terms since the differences in explicit terms between organizations is not germane to understanding the priorities about dwelling design. To allow flexibility on iterative readings of the documents, categories can be added through the coding process. This content analysis codes for the *existence* of each concept within each state’s QAP and related documents, and codes for *frequency* of topic across states. The coding and memoing process borrows from constructivist grounded theory (Charmaz 2006) though the intention of this research is not yet to create an emergent theory about the state of dwelling design guidance in tax credit housing policy.

The steps taken to carry out this research are as follows:

1. Collect most recent Qualified Allocation Plan (QAP) from each state’s allocation authority.
2. *First examination of documents*: Skim QAPs and highlight design guidance. Begin code book based on first examination. Create validity through consistent translation and use of synonyms.
3. Note reference within QAP to Design and Construction Standards (DCS) and collect these documents from state allocation authority website.
4. Search each allocation authority website for past and present DCS documents.
5. *Second examination*: Using qualitative coding software (MAXQDA), read and code all QAPs and DCS documents. Use first code book as a base and develop additional emergent codes.
6. Memo each set of codes to develop themes and concepts. Combine similar codes into one.
7. *Third examination*: Reread relevant documents to add evidence to themes and concepts. Focus on general trends and patterns.
8. *Fourth examination*: Carefully reread QAPs with no design guidance found on previous reads.
9. Write final memos on each code. Draw thematic connections between codes.

The final code book contains the following categories and codes:

Policy Type	Dwelling Scale	Room Scale
DCS Required	Unit Size Minimum	Bedroom Size
QAP Required	Unit Size Maximum	Kitchen Size
QAP Points	Unit Size Target	Living Room Size
QAP Set-aside	Bathroom / Bedroom	Proportional Spaces
		Furnishings
		Unit Layout

The availability of design guidance within the documents ranges from quite obvious (e.g. subtitles in the Table of Contents such as “Unit layout requirements for all tax credit projects”) to hidden in unlikely places, such as the list of deliverables for application submission. For some states, design and development standards are within the QAP itself, in an appendix. The iterative approach outlined above allowed for a rigorous and methodical sifting of thousands of pages of information to find the text most relevant to the goals of this study.

To understand the frequency of dwelling design policy instruments in the QAPs and DCS documents across states, descriptive statistics such as mean, median, and mode are employed, specifically when the policy is quantitative in nature such as minimum unit size or minimum bedroom size. To understand the overall commitment to dwelling design direction, each state is scored on the existence of content at each of the scales and on the comprehensiveness of its direction at the room scale.

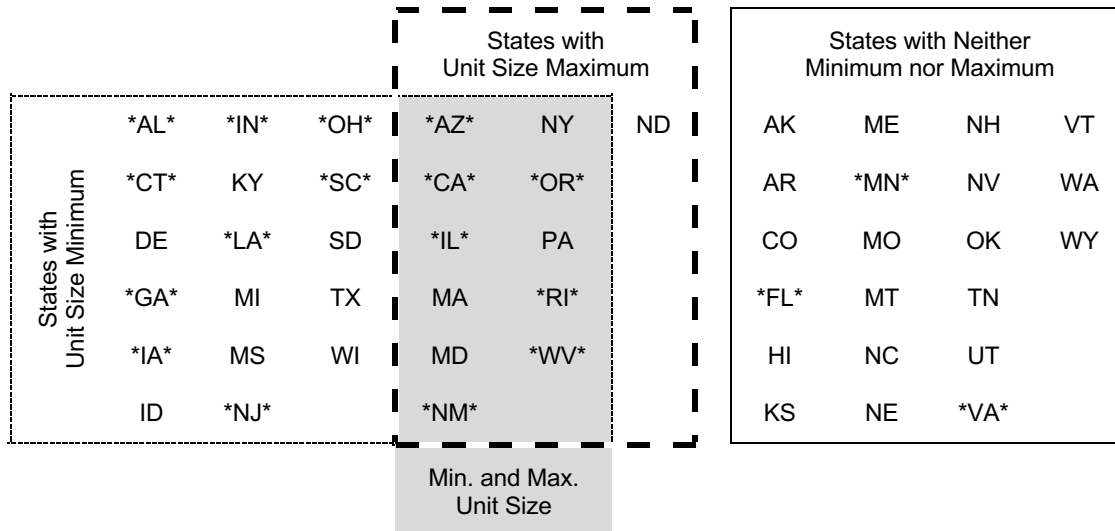
## 2.0. FINDINGS

The conceptual content analysis of the state policy instruments reveals two categories of scale: *dwelling scale* minimum and maximum size requirements, including prescriptive bathroom/bedroom ratios; and *room scale* requirements such as floor area or minimum dimensions for individual rooms of the dwelling. Within each of these categories exist both performance and prescriptive criteria, and, depending on the state, both explicit and implicit direction. The following

subsections will present the results for each category of scale in turn. The final subsection will present the results from the aggregate analysis of these categories to set the stage for recommendations made in the discussion section.

### 2.1. Guidance at the Dwelling Scale

At the dwelling scale, there are two categories of guidance: direction on floor area and direction on the number of bathrooms for a given type of dwelling (studio, one-bedroom, etc). States that institute unit-size and bathroom ratio minimums also state intentions about resident well-being. The intentions behind unit-size and bathroom provision maximums are related to cost conservation. Dwelling size guidance varies considerably from state to state. Figure 1 shows the frequency of dwelling size and bathroom ratios across the fifty states.



**Figure 1.** Diagram showing the dwelling scale guidance across states: unit size minimum, maximum, both minimum and maximum, and bathroom ratio by dwelling type. \*XX\* designates state with bathroom ratio guidance

#### 2.1.1. Dwelling Size Minimums

*Dwelling size minimums* are the most common type of design direction. Twenty-eight states include dwelling size minimums, either alone or in combination with maximum permitted areas. These minimums are a requirement for all LIHTC financed dwellings within the jurisdictions, with the exception of West Virginia, whose dwelling size minimums are part of the competitive point system within the Qualified Allocation Plan (QAP). All states with minimum dwelling size guidance include a table or paragraph with the quantitative requirements.

On occasion a state will also include more subjective language, such as Georgia’s Design and Construction Standard: “Submissions that appear to violate the spirit and intent of these (dwelling size) minimums may be considered a poor use of resources.” New Jersey and Illinois set minimums with alternate policy mechanisms that reward increasing the size, through QAP points. New York accommodates the differing expectations between residents in New York City and smaller cities by allowing a reduction of 50 square feet per dwelling for projects within the City.

#### 2.1.2. Dwelling Size Maximums and Targets

There are twelve states with dwelling size maximums in their QAP or DCS. Only one state, North Dakota, has unit size maximums with no minimums. This is consistent with other guidance found in their QAP, such as cost and overall building efficiency. The eleven other states have both minimums and maximums. The required range in size for each dwelling type can be quite wide and accommodating, such as Pennsylvania which has as much as 400 square feet between minimum and maximum, to a more common 250 square foot range for Rhode Island, West Virginia, Arizona, and Oregon. Massachusetts’ QAP requires unit “target sizes,” noting that “units much larger or smaller than these targets will be questioned in terms of livability or excess cost.” Maryland’s very narrow (less than 100 square feet) range between minimum and maximum unit sizes also functions as a target, albeit with more objective and enforceable standards than Massachusetts.

In Figure 2, below, the minimum and maximum unit sizes are plotted for comparison for the three most common dwelling types: one-, two- and three-bedroom. This diagram makes intuitive an understanding of the mode and median for each dwelling type. It also reveals idiosyncrasies: e.g. Maryland’s maximum two-bedroom dwelling size (720 square feet) is less than South Carolina’s minimum one-bedroom size (750 square feet). The ranges between minimum and maximum mentioned in the following paragraph are also manifest in this diagram.

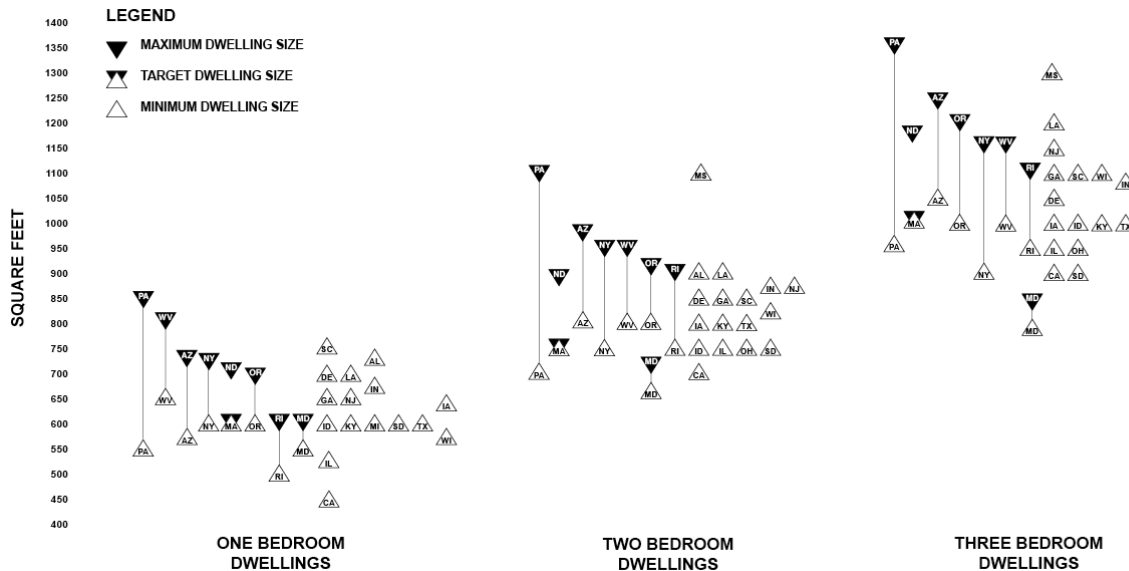


Figure 2: Dwelling size minimums, maximums, and targets for 28 states with guidance.

### 2.1.3 Bathroom/Bedroom Ratios

Typical bathroom requirements relate to the number of bathrooms and fixture types (tub or shower) for each unit type. After *unit size minimum*, this is the most frequently coded guidance across states: 19 provide direction. The most common ratio is a full bath for one- and two-bedroom units and two full baths for three- and four-bedroom units. Allowing a shower and a bath (1.75 baths) for three-bedrooms also appears. Most of the relevant states provide bathroom/bedroom ratios as *targets*, without opportunity for the developer and designer’s choice. However, Virginia sets the ratio as a minimum and Oregon allows a choice between 1 and 1.5 baths for two-bedroom units and 1.75 and 2 baths for three-bedroom units.

## 2.2. Guidance at the Room Scale

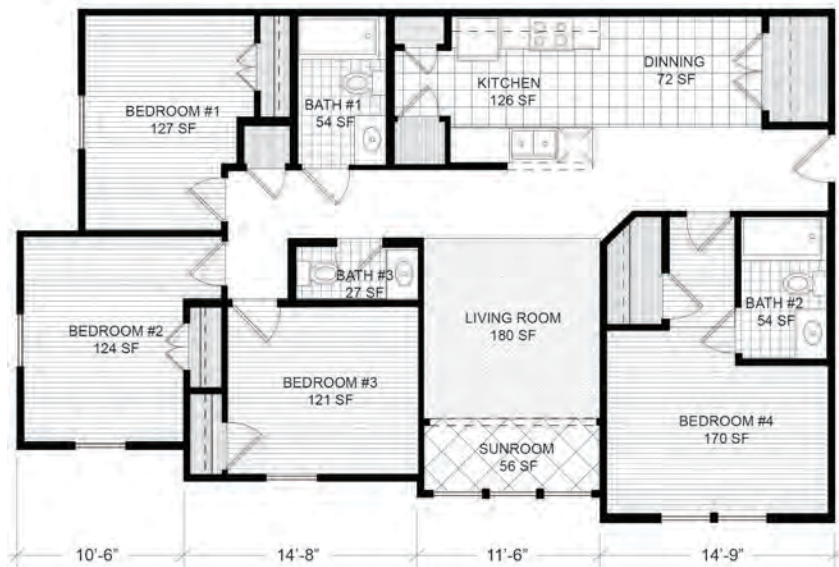
Unit minimum sizes are not the only means to encourage or require livability for the residents of the LIHTC-financed dwellings. Connecticut has limited guidance on unit size but requires specific furniture to be accounted for in the unit plan drawings. Maine has no guidelines for overall unit sizes but has highly specific requirements for bedroom sizes and room combination sizes (such as an eat-in kitchen, or a living/dining room arrangement.)

### 2.2.1. Room Sizes

Twenty-one states provide explicit, quantitative guidance on room dimensions within the dwelling. The most common room is the bedroom; twenty states mandate either a minimum floor area or minimum clear wall dimensions for at least one bedroom. Eleven states enhance this direction, providing both minimum floor area and minimum linear dimensions for all bedrooms, differentiating between primary and secondary bedrooms. For the primary bedroom, the median minimum floor area is 117 square feet and the mode is 120 square feet; for the secondary bedrooms, the median and mode are both 100 square feet. At the high end, and a clear outlier, South Carolina requires a primary bedroom of 170 square feet and a secondary bedroom of 120 square feet (Figure 3).

The living room is governed half as frequently as the bedrooms: ten states regulate the floor area, the dimensions, or both. The median and mode for the living room area is 150 square feet; Connecticut has the smallest minimum area at 121 square feet. The Massachusetts guidance is the most detailed: they require a 12’ minimum clear dimension along an exterior wall with access to natural light and a 10’ clear minimum dimension on the opposite wall.

States employ very different ways of directing and calculating kitchen size: countertops length, overall kitchen dimensions, overall kitchen area, appliances. When a state includes any guidance on kitchen, they are also highly likely to include proportional space guidance (i.e., the countertop length changes with dwelling type). For example, from Minnesota, “Kitchen counter work minimum area must be 6’-0” for one-bedroom Dwelling Units, 7’-0” for two- and three-bedroom Dwelling Units and 8’-0” for larger Dwelling Units.” This idea of proportional space is described in more detail in the following paragraph.



**Figure 3:** LIHTC financed four-bedroom dwelling in South Carolina as demonstration of QAP guidance on room sizes.

### 2.2.2. Proportional Space

The code *proportional space* is utilized when the guidance differentiates room requirements based on dwelling type: the documents from fifteen states were tagged with this code. Arizona articulates this intention clearly in their QAP: “The areas of common spaces of units, living area, kitchen, dining, etc., shall increase in proportion to the number of bedrooms.” Bathroom and kitchen direction frequently takes into account the dwelling type. Six states—Arizona, California, Massachusetts, Maine, Oregon, New York—include the living room in the list of the rooms that must get larger as the overall dwelling size increases. While many states have strong intentions, some of the guidance lacks specifics and is open to interpretation. California’s QAP, for example, has this clause: “living areas shall be adequately sized to accommodate families based on two persons per bedroom.” Finally, the proportional space given to dining is cross-coded with “furniture” as it relies on the inclusion of an appropriately sized table and number of chairs.”

### 2.2.3. Furnishing

The QAP and DCS documents from ten states give direction on furnishability. This direction ranges from purely performance based to highly prescriptive, with some hybrid approaches in between. At the performance end of the continuum is Maryland’s, which simply states: “(Ensure) the layouts are efficient, with practical traffic flow, and provide adequate space for furniture placement.” Michigan states their expectations with this language: “The adequacy of the design of dwelling units shall, for the greatest part, be measured by the dwelling units ‘furnishability’ and the inclusion of several key components.” Rhode Island dwelling sizes are also evaluated on a performance basis. Determining factors are the placement of furniture, tenant circulation, functional livability and adequate storage. Oregon and Mississippi provide performance guidance with the designer as the clearly intended audience. Like Massachusetts and Connecticut, Oregon requires the tax credit application to include furnished dwelling plans.

During the analysis, furniture walls emerged as a code for three of the states. As defined here, a furniture wall is a wall without door or window obstruction. This is a prescriptive requirement that can be objectively checked on the plans. Maine’s DCS notes: “Primary bedrooms shall have at least one wall of at least 10 feet uninterrupted by openings less than 44 inches above the floor.” New York requires, “A minimum of one wall, preferably two, should be provided with no fenestration or interfering doorways to allow for adequate furniture placement.” Rhode Island defines a furniture wall as a “wall without windows” and requires two in the living rooms, two in each bedroom and one in the dining room.

At the most prescriptive end of the spectrum, six states – Connecticut, Massachusetts, Michigan, Minnesota, Oregon, and New York – specify exact pieces of furniture for rooms in the dwelling. Connecticut, Michigan, and Massachusetts are the most prescriptive and the most comprehensive: each state lists pieces of furniture and their dimensions for dining room, living room, and bedroom. Oregon, New York, and Minnesota are very specific, but less comprehensive, issuing dimensions for the bedroom only (New York and Oregon) or dining room only (Minnesota).

### 2.2.4 Dwelling Layout

The *dwelling layout* code is used to denote qualitative guidance from the states on the configuration of the dwelling, as opposed to the quantitative direction such as minimum area or length of a room. *Dwelling layout* is found in the *room scale* set of codes because it describes the relationships between the rooms more than the overall floor area of the dwelling. Nine states have qualitative language in the DCS or QAP related to unit layout. Nearly all of the guidance



is qualitative, and much of it is subjective. The nine states with this code include some aspect of circulation within the dwelling. There is also frequent crossover with the code, *furnishing*; many examples referenced in the previous section were also coded with *dwelling layout*. In addition to these patterns, there are unique priorities. Mississippi’s QAP directs architects to “consider how rooms can be arranged to accommodate working at home.” Massachusetts’s DCS states: “Locate living and dining areas in the corner of the building in corner units to benefit from windows facing multiple directions.”

### 2.3. Guidance Across States: Trends and Patterns

After each code instance is analyzed for frequency across states, the data reveal three distinct levels of dwelling design guidance (Table 1). Every state in Group ‘A’ provides explicit direction at the room scale and dwelling scale. The Group ‘B’ QAPs address one of the two scales, though the guidance on room scale attributes from this group is very limited. Group ‘C’ QAPs do not address room scale nor dwelling scale attributes.

**Table 1.** Intensities of Guidance at the Room Scale and Dwelling Scale Across States.

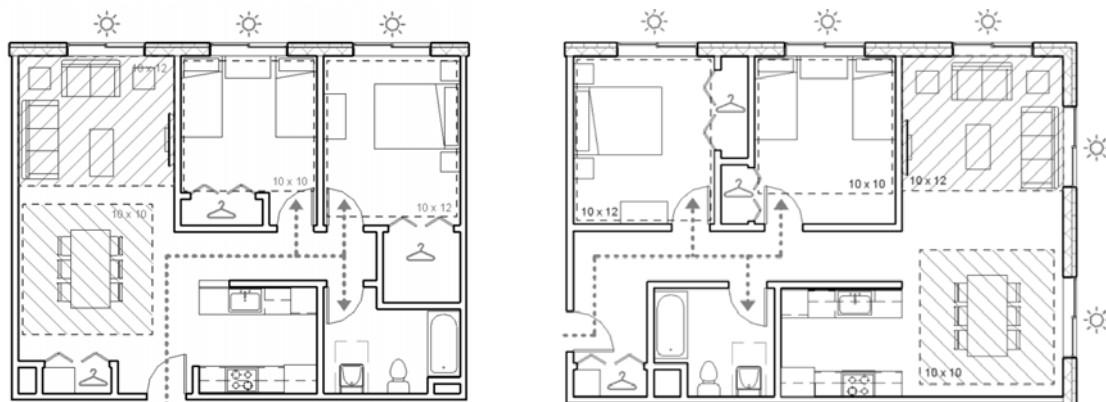
Group A: Comprehensive			Group B: Moderate			Group C: No Guidance		
State	Room Scale	Dwelling Scale	State	Room Scale	Dwelling Scale	State	Room Scale	Dwelling Scale
AL	••	••	DE		•	AK		
AZ	•	•••	FL		•	AR		
CA	•	•••	IA		••	CO		
CT	•	••	ID		•	HI		
GA	•••	••	IN		••	KS		
IL	••	•••	KY		•	MO		
MA	••	••	LA		••	NC		
MD	•	••	ME	•••		NE		
MI	••	•	MT	•		NH		
MN	••	•	ND		•	NV		
MS	••	•	OK	•		TN		
NJ	••	••	PA		••	UT		
NM	•	•••	SD		•	VT		
NY	•	••	TX		•	WA		
OH	•	••	VA		•	WY		
OR	•	••	WI		•			
RI	•••	•••	WV		•••			
SC	•••	••						

While there may be a temptation to numerically rank the states based on the dwelling design direction in their QAPs, the subjective nature of some of the categories and the overlap between criteria means the method of sorting into groups is more reliable, more valid, and more useful. Should Maine, with dimensional and floor area criteria for every room but lacking a dwelling size minimum, score higher than Minnesota which addresses each scale, but with limited direction? Such comparisons would require false equivalency. Analysis of each of these groups and within each group is more productive for assessing the usefulness of the direction in designing housing using the tax credits. These group assignments will inform the discussion of future research in the following section.

## DISCUSSION

The results from this study reveal a range of direction from state housing tax credit allocation authorities on the design of dwellings for people with low incomes in the United States. Each state, presumably through a stakeholder input process, has created guidance for architects that reveals the state’s priorities on livability and cost effectiveness. Whether or not this guidance directs the design attributes of the dwelling and its rooms varies by state and thus the analysis process grouped the states into three general categories. The concerns raised by the research are specific to each group of states.

States in Group A such as Massachusetts, whose DCS goes as far as to provide example floor plans (Figure 4) may be operating at the risk of replicating problematic units if the constructed projects do not undergo post-occupancy evaluation. If they haven’t already done so, Group A states are to encouraged commission research to test the assumptions and requirements.



**Figure 4:** Floor plans of exemplary, furnished, two-bedroom dwellings provided in the Massachusetts Department of Housing and Community Development DHCD's Design Requirements 2020-2021.

Group B states with unit size minimums but not maximums could look at the units built within the minimum to understand if there is a natural ceiling, and if a maximum would be beneficial. States have two existing pools of data that can be analyzed to create evidence-based guidance: the existing tax credit dwellings and the market studies of nearby non-tax credit financed dwellings that are a requirement of all QAPs. Group B states would be well-served to investigate room size minimums and furnishing requirements to ensure a standard of livability for the residents.

The states in Group C do not provide explicit guidance; instead they give full authority to approve the designs of applicants' projects to staff members at the agency. For example, New Hampshire states in the DCS, "Acceptable dwelling unit and room sizes shall be evaluated by Authority Staff or designee." This top-down review process is opaque to the designer as compared to the clear guidance in a document such as Maine issues. This process is problematic because it rewards "insiders" to the process, the same architects and developers who have likely made successful applications in the past.

This is the first quantitative research project investigating the design direction from QAPs and DCS documents for tax credit financed housing in the US. This inventory provides a foundation for future studies in this research area. There are clear qualitative directions for future research that can build on this research.

Research moving "upstream" can be guided by research questions such as: How are these policies developed and set by the stakeholders? What is the process? What are the histories of specific directives? For states without minimum or maximum dwelling size requirements, why or why not? How do these directives affect the architects designing the buildings? Do these constraints hinder or enhance the design process? How do the density expectations of the geographical location of the housing affect the direction, e.g., New York City's smaller dwelling size? Primary research investigating the well-being of families in the dwellings, even just to test the assumptions about furniture, would provide more evidence for the direction passed down from the government.

The creation, implementation and application of the QAP design guidelines have social, spatial, economic, and political implications. This research is relevant to architects of affordable housing for both pragmatic and positivist reasons. First, understanding the specific requirements for a given state can ease and enhance the design process. This is especially true for architects new to this project type, or those transitioning from other housing design work with less restrictive guidance. Second, understanding the guidance across states, in particular states with clear, evidence-based recommendations, can enrich the design of affordable dwellings nationwide. Similarly, the findings from this research will impact future developments in affordable housing by revealing the best practices to planners, policy makers and designers, allowing each group to appropriately advocate for dwellings that enhance the quality of life for the residents. Change in housing design relies on change in housing policies.

## CONCLUSION

This study inventories the Qualified Allocation Plans and Design and Construction Standards for the Low- Income Housing Tax Credit allocation authorities of all fifty states. Using the methods of a Conceptual Content Analysis enables a broad understanding of the types and frequencies of the direction given to designers of the dwellings created through this policy mechanism. The guidance revealed by the analysis is qualitative and quantitative, subjective and objective in nature. More than half of the states provide direction at the scale of the dwelling, including: minimum, maximum, and target dwellings sizes and bathroom ratios. Slightly less than half the states include guidance at the room scale and unit layout, including: minimum dimensions for bedrooms and living rooms; proportional direction on kitchen and dining room arrangements; and both quantitative and qualitative direction on furnishability.

Overall, states fall into three general groups on how much direction they provide: those with a high amount and specificity of direction across all scales and categories; those with a moderate amount, across fewer scales or categories; and the fifteen states with no guidance on dwelling design. Through the content analysis, this study established the stylized facts of this group of policy documents. Future research will investigate why and by which stakeholders the policies were implemented and how the design decisions affect the families who live there.

## ACKNOWLEDGEMENTS

Yue Shi, graduate student at UIUC contributed valuable graphic production assistance on this project.

## REFERENCES

- Charmaz, K. (2006). *Constructing Grounded Theory: A Practical Guide Through Qualitative Analysis*. Pine Forge Press.
- Fuhry, L., and W. Wells. "Green goes mainstream in low-income housing." *Planning* 79, no. 9 (2013): 31-35.
- Gustafson, Jeremy, and J. Christopher Walker. *Analysis of state qualified allocation plans for the low-income housing tax credit program*. US Department of Housing and Urban Development, 2002.
- Horn, Keren M., and Katherine M. O'Regan. "The low income housing tax credit and racial segregation." *Housing Policy Debate* 21, no. 3 (2011): 443-473.
- Krippendorff, K. (1980) *Content Analysis: An Introduction to its Methodology*. Sage, Thousand Oaks, California.
- Lens, Michael. "Employment accessibility among housing subsidy recipients." *Housing Policy Debate* 24, no. 4 (2014): 671-691.
- Ports, Katie A., Whitney L. Rostad, Feijun Luo, Michelle Putnam, and Elizabeth Zurick. "The impact of the low-income housing tax credit on children's health and wellbeing in Georgia." *Children and youth services review* 93 (2018): 390-396.
- Robinson III, John N. "Fair Housing After "Big Government": How Tax Credits Are Reshaping the Legal Fight Against Racial Segregation." *Housing Policy Debate* 29, no. 5 (2019): 752-768.
- Shi, Marc, Abigail Baum, and Craig E. Pollack. "Perspectives on Integrating Health Into The Low-Income Housing Tax Credit: A Qualitative Study: Study examines perspectives of housing sector stakeholders on the opportunities and obstacles of including health-related criteria in Low-Income Housing Tax Credit funding decisions." *Health Affairs* 39, no. 4 (2020): 622-630.

# Kawneer's "Machines for Selling" Modernism in the Post-war United States

Tait Johnson<sup>1</sup>

<sup>1</sup>University of Illinois at Urbana-Champaign, Urbana, IL

**ABSTRACT:** A "Machine for Selling" prototype was developed by Kawneer, a manufacturer of architectural storefronts, shortly after World War II. Not a machine in the traditional sense, this was instead a comprehensive store system designed to spur interest in renovation by merchants and appeal to shoppers in the postwar period. Significantly, Kawneer envisioned mass-renovation of storefronts using the prototype by designing entire blocks at a time. The downtown of Niles, Michigan, as Kawneer's hometown, in effect served as a test site.

Storefronts were covered in aluminum cladding and remodeled with storefront systems over many decades, showcasing the company's evolving product lines as they were deployed on independent, merchant-owned stores. By the late twentieth century, this resulted in a unified, brown, corrugated aesthetic stretching across blocks of the downtown district. This paper examines the history of Kawneer and shows how its use of a commercial district as a marketing landscape was a function of translating the company's ideas into modernity and prosperity - two terms resonant with postwar capitalism and a rapidly expanding economy.

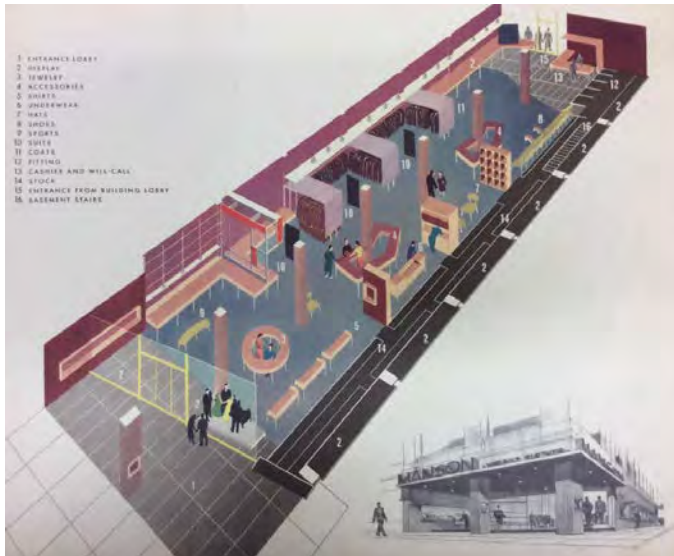
Kawneer organized a formal design department immediately after World War II as part of its overall corporate structure. The company, founded by architect Francis Plym in 1906 to initially manufacture storefront window systems, expanded to embrace aluminum and glass as principal design elements. Working closely with architects like Ketchum, Gina & Sharp, and advised by Mies Van Der Rohe and William Lescaze, Kawneer's ambitions broadened from storefronts to the renovation of entire districts. Niles' downtown served as a feedback loop for the company's ideas, wherein not only did the company try new products, but it also deployed marketing concepts locally before expanding nationally.

Niles became a marketing landscape for Kawneer in which terms such as "modern" and "prosperity" were used, which were also found in marketing messages by other manufacturers eager to focus a buyer's attention on a potential bright, shining future after the ravages of World War II. Drawing from the archives of Kawneer in comparison with other aluminum manufacturers such as Reynolds, this paper suggests the need for increased scrutiny on the impact of manufacturers like Kawneer on the development of modern architecture. Twentieth-century manufacturers deeply affected the built environment, not only by associating themselves with famous architects who could amplify their impact, but also through attempts to organize the commercial landscape itself as a marketing landscape.

**KEYWORDS:** History, Modernism, Materiality, Manufacturing, Prefabrication

## INTRODUCTION

A Machine for Selling was a prototype store designed by the architectural products manufacturer Kawneer to sell their products and improve the profitability of the merchant who bought into the store design recommendations. (Fig. 1) It included a facade design, product layout scheme and floor plan. By extension, claimed Kawneer, not only the merchant but also the entire community would be more prosperous. This paper examines the history of Kawneer and shows how its postwar product planning and marketing initiatives, collaborating with famous modernist architects, significantly influenced twentieth-century architectural modernism. Because the consumer sphere was the locale in which most Americans experienced modernism, Kawneer helped define it in the United States.



**Figure 1** A Machine for Selling. Source: Machines for Selling, 1946.

Modernism did not come to the United States with Walter Gropius - it was already here. Widely taught is the influence of concrete grain elevators on Avant-garde European architects, but less studied is the other home-grown modernism that emerged in the small towns and Main Streets of America. Architectural historian Gabrielle Esperdy argues convincingly that the architecture of mid-twentieth-century commercial districts was not a borrowed modernism but was instead a fully realized modernism.<sup>i</sup> Modernism, however, emerged much earlier in the United States as a decentralized and distributed set of beliefs and approaches not only tied to the major seats of intellectual and financial capital, but also to the everyday commercial landscapes of common commercial districts. Kawneer played a defining role in architectural modernism with the deployment and subsequent spread of its earliest product - a resilient metal window frame, which facilitated the use of increasingly large panes of display windows eschewing ornament for rational and minimalist storefronts of glass and metal.

### 1.0 FOUNDING KAWNEER

In 1907, Kawneer was founded by Francis J. Plym to develop a patent that improved the fastening of glazing to a frame. (Fig. 2) Responding to the widespread deterioration of wood storefront window frames due to moisture retention from condensation on the window interior, Plym developed what the company called a “rustless” metal façade. The system consisted principally of resilient metal framing – first copper and after World War I, Aluminum – as well as metal cladding above and below the storefront window. Finding increasing sales, Plym moved the corporation from a shop in Kansas City to Niles, Michigan in 1907, soon growing to include factories in Niles and Berkeley, California, bolstered by dozens of sales offices across the country. Although the window frame patent was the initial product, the company soon grew into a nationwide manufacturing corporation of frames, doors, windows and facade systems.



**Figure 2** “Metal Sash No. 30.” One of Kawneer’s first products was a copper clamping system that formed a sash around storefront windows. Source: Kawneer Store Fronts, 1912.

### 2.0 THE MODERN STOREFRONT

After World War Two, Kawneer positioned its marketing messages around the prospect of prosperity enabled by the *Machine for Selling*. Before the war, however, it was concerned principally with defining the storefront as *modern*.<sup>ii</sup> The company claimed they sold the “first truly modern store front” in 1906 to a merchant in Holdredge, Nebraska. Materiality

likely constituted a central place in Kawneer's definition of modernity, as Kawneer celebrated the store's large windows and metal frame in the lore of company history.

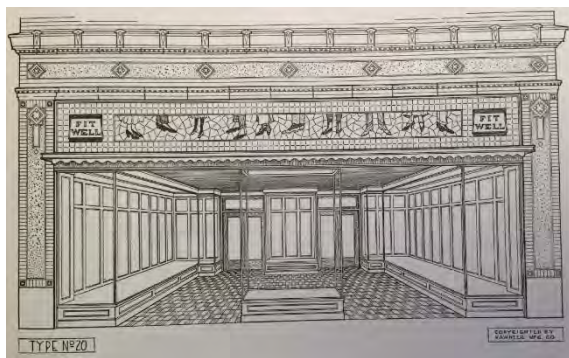
Beyond materiality, Kawneer marketed the benefits of their storefront system in terms of *profit*, signaled by an early slogan about its store front system, "It stays and pays." Profitability was a function of materiality, they argued, due to the resistance to deterioration and rot of their resilient metal framing. Furthermore, profitability was argued as a time-dependent function, wherein higher expenses incurred with the Kawneer system would yield future dividends despite higher up-front costs.<sup>iii</sup>

Profitability is not solely a condition of modernity. Yet, Kawneer believed profit for the merchant, and by extension the corporation, would result through the construction and renovation process they frequently termed "modernization." A catalog from 1917 announced, "People of the smaller towns, as well as those in the rural districts, demand modern retailing — many times travel miles to trade under modern conditions."<sup>iv</sup> This catalog, entitled, "Boosting Business," claimed that to be modern was to make stores profitable.

Kawneer grew rapidly in the 1920s, preceded by over 56,000 Kawneer storefronts sold in the United States at the beginning of the decade. During this decade, Kawneer still focused on the façade, not yet considering the store as a unified system. The company employed its own designers to develop storefronts for merchants, guided by a belief that "excellence in design" accompanied "absolute absence of all bulky and cumbersome parts." This translated into a large display windows which minimized the mullions and maximized the display space. The designers understood the need for "sales-producing" as a central "store front problem," in which the central issue was to facilitate the merchant's product sales.<sup>v</sup>

### 3.0 A FOCUS ON MODERN DESIGN

Francis Plym initially saw his endeavor as a technical problem, but it grew increasingly focused on design after the 1920s. As the company focused on design as a means to profit, it embraced the aesthetics emblematic of modernism. Although Plym secured over 100 patents for solutions to various technical problems in material assembly, he was first educated as an architect first and sought to position Kawneer's image as a design-focused company. "Each part [is] designed in harmony with every other," said one brochure. Before World War II, design was an activity undertaken by the company itself rather than outside designers. In the company's first decades, Kawneer found that architects were largely unaware of the company's offerings, which led the company to market not to architects as much as it marketed to merchants themselves. Merchants were encouraged to sketch their ideas and send them to the nearest Kawneer branch office to "develop a store front for you."<sup>vi</sup> As the volume of Kawneer products increased, architects became increasingly knowledgeable about the company's products leading to marketing activity directed towards architects in addition to merchants. In the 1930s, Kawneer reflected this change of audience, imploring merchants to "consult your architect for a store front exactly suited to your needs."<sup>vii</sup>



**Figure 3** Kawneer Design Type no. 20 Source: Kawneer Portfolio of Designs, 1917.

Kawneer's emphasis on the frame, accentuated by its functional purpose of transparency to highlight the merchant's products within the store had aligned it with an aesthetic of minimalism from its earliest founding. Advertising in 1912, for instance, it wrote, "Every feature incorporated in Kawneer is there because it is needed. There are no unnecessary parts built in to cause complication."<sup>viii</sup> (Fig. 3) Although Kawneer had long claimed to be a founder of modern store front design (recall their assertion that they developed the "first truly modern store front,") eschewing ornamentation and embracing a minimalist aesthetic, the company did incorporate decorative design elements during the 1920s, as can be seen above the entrance of prototype store designs such as "Kawneer Design Type no.20." Such facades included colored, decorative tile and brick juxtaposed with thin metal frames and large plate-glass windows at the entrance, devoid of ornamental pretensions.

With decades of focus less on ornament and more on transparency and a claimed modern identity, by the late 1930s the company's designs fully embraced the increasingly popular International Style aesthetic. The sleek, ornament-free facades of the International Style aligned easily with the standardized, extruded and rolled metal components produced at Kawneer's factories.<sup>ix</sup> The company amplified its focus on aesthetic modernity when it switched from copper, brass and other metals to aluminum. By the 1930s, aluminum was solidly associated with modernism through the marketing efforts of Alcoa.<sup>x</sup> In 1937, Kawneer maintained it was the largest user of aluminum for architectural applications.<sup>xi</sup> After Francis Plym's son Lawrence took over the company, he promoted a slogan which included the phrase, "Keep it simple, keep it in aluminum."<sup>xii</sup>



**Figure 4** All Metal Store Front in Lausanne, Switzerland. Source: The Kawneer Book of Store Fronts, 1936.

Beyond aesthetic minimalism and materiality, the company also sought to associate its storefront designs with avant-garde glass and aluminum facades in Europe, such as the "All-metal store front in Lausanne, Switzerland" by Alberto Sartoris, with a ribbed metal planar façade through which are punched openings for a door and display window. (Fig. 4) Accompanying these European examples were storefronts with Kawneer systems to strengthen the association between modern architecture and Kawneer.

Kawneer found the association of modernity with profit to be advantageous in marketing, and this association formed the underpinning of arguments put forth to merchants: "The Modern Kawneer store front gets results with today's customers."<sup>xiii</sup> The results Kawneer spoke of were written about in rational terms, wherein the company believed that profit could be honed "scientifically" by developing the store as a comprehensive system.<sup>xiv</sup> The first step, in Kawneer's formula, was to enhance the storefront at the sidewalk. The second was to attract customers into the store, get them to buy, and then eject them for a "quicker turn-over."<sup>xv</sup> This was envisioned as a mechanical process. Although there were no empirically-robust studies comparing the profitability of a Kawneer storefront to a traditional storefronts, Kawneer maintained "proof" could be had if one were to simply "Look around you," talks to merchants with Kawneer storefronts "and prove it to yourself."<sup>xvi</sup> Elements of the formula included a façade that was "sensible, modern design" with large metal letters overhead, reflecting an "age of speed." With bright lighting and display of goods, an "impressive spectacle" was the desired outcome.<sup>xvii</sup> The hometown of Kawneer, Niles, Michigan, served as a testing ground for this "proof," wherein 73 of the town's businesses had Kawneer store front products by 1923. This town would become the deployment site envisioned for Kawneer's *Machines for Selling* initiative after the war.

#### 4.0 POST-WAR STOREFRONT PLANNING

During World War Two, Kawneer's plants turned to war production, building gun turrets and airplane parts for the United States military. Toward the close of the war, like many industrial producers and manufacturers, executives began planning a postwar recovery of the company, anticipating an expanding consumer economy. Their strategy was to associate with famous architects to promote the company brand to architects and buyers. A precursor to the *Machines for Selling* initiative was the "The Store Front of Tomorrow." This 1943 competition for students and professionals was juried by well-known modern architects such as Mies Van Der Rohe and William Lescaze, and chaired by Morris Ketchum, Jr. (Fig. 4) Out of this competition came recommendations that any storefront planning should be comprehensive: not a single storefront but a group of stores designed together. The second significant recommendation was that stores be designed beyond the front façade, to include the entire store within. The jury was impressed by one particular design which pushed the front façade deep within the store's volume, extending the outdoor space underneath the upper stories above to merge public and private showroom space into one flowing continuum.





**Figure 4** Left to right: Members of the jury, Roland Wank, Morris Ketchum Jr., Samuel Lunden, Frederick Bigger, Mies Van Der Rohe. Source: The Kawneer Front, 1943

Emboldened by associations with famous modern architects and inspired by the “Store Front of Tomorrow” suggestions, Kawneer established a formal Design Department tasked to “create and develop, through research and design, modern ideas in stores” whereby these ideas “are guides to architects, distributors, and designers and increase the public interest in good design and good materials.”<sup>xviii</sup> In 1945, this department began planning the *Machine for Selling*.

### 5.0 A MACHINE FOR SELLING

As an output of the Design Department, there was not a singular machine, but multiple machines developed for a range of typologies: a pharmacy machine, shoe store machine, and department store machine, among others. Such *Machines* could be manifest as new construction, or like Reynold Hardware in Niles, deployed as a renovation of an existing façade. The prototypes of these machines were rendered in elevation and elaborate perspective plans to show comprehensive design synergy between storefront and floor plan. (Fig. 5) Hand in hand, a store became a machine when it was comprehensively modernized: “Store-front, interior and all the hidden gears and levers of trade...from sidewalk to service alley.” Kawneer outlined three main functional goals. First, “catch the eye” of customers to exemplify the merchant’s goods behind the glass. Second, like a stage, show and dramatize the merchandise to induce a customer’s desire to buy. Third, invite shoppers from the sidewalk into the store.<sup>xix</sup>



**Figure 5** Reynolds Department store. Source: *Machines for Selling*, 1946.

The Design Department worked with the architecture firm of Ketchum, Gina, and Sharp to design the 53 prototypes. The storefront was designed to encompass both the ground level and any stories above. Where a building was to be renovated, the “modernization” was to span “from top to bottom” with a slipcover of aluminum covering up any existing brick, stone, or ornamental details with corrugated sheets of metal. Behind the façade the design emphasized flexibility for displays, backgrounds, lighting, and advertising elements that could be dynamically changed with new marketing campaigns.

Recalling the suggestions of the “Store Front of Tomorrow” project, Ketchum, Gina, and Sharp extended the machine from the single store to the entire street front. (Fig. 6) Niles was envisioned as a future commercial landscape of marketing in which every store was simultaneously redesigned. Kawneer intended this to be a modernization project to cause the final result: prosperity. Modernization was the process, the machine was the project, and prosperity was supposed to be the outcome.

The two conditions of *modernity* and *prosperity* resonated with an expanding, postwar economy in consumer landscapes like downtown “Main Streets.” Coupled with the fervor for postwar planning, Kawneer combined the ideas into a brochure entitled, “A Plan for Modernizing Mainstreet,” where “a prosperous community is a better community.” Kawneer urged townspeople to organize together and demand new storefronts to spur prosperity and define the downtown as a shopping center. Rather than piecemeal, Kawneer suggested such groups collaborate with architects to “make designs for the first block – all at one time.” Not only did these instructions mirror the “Store Front of Tomorrow’s” suggestion for a block-wide approach, it also echoed the larger momentum in the commercial, industrial, institutional, and even familial spheres toward post war planning as a horizon beyond war and economic depression.

xx



**Figure 6** Ketchum, Gina & Sharp, Main Street Block renovation, Niles, Michigan, promoted as “typical American city.”  
Source: Remodeled Main Street, Niles, Michigan, 1945.

## 6.0 COVERED IN KAWNEER

Townspeople in Niles did not organize together in the way Kawneer hoped. While individual merchants did continue to purchase Kawneer products in a piecemeal fashion, the all-encompassing comprehensive project did not come to fruition in the immediate postwar period. Kawneer expanded beyond store fronts in the prosperous 1950s and 1960s, developing cladding systems for high-rises and a range of expanded architectural products that served an expanding postwar economy.<sup>xxi</sup> Yet, Kawneer capitalized on a developing threat to downtowns - the regional mall – and successfully argued to decisionmakers in Niles that the comprehensive project should finally be implemented. In 1972, amid beliefs that regional malls were stealing customers away from downtowns across America, dozens of stores along Main Street in Niles were “covered in Kawneer” with a product called *Shadowform*.<sup>xxii</sup> (Fig. 7) This corrugated brown metal spanned from the top of the façade to the top of the glazed storefront at street level, simultaneously emulating modernist facades of new regional shopping centers and covering up facades, protecting them from further deterioration by the elements.



**Figure 7** Shadowform on a block of buildings, Main Street, Niles, Michigan, installed 1972.  
Source: Nicolina Curcuru, Herald Palladium.

*Shadowform* fell out of favor as the Preservation Movement found wider acceptance grants became available to renovate downtown facades with federal, state and local funding. In 2002, reflecting a merchant’s belief that “they need to fix this town up, and make it look like it did at the turn of the century,” decisionmakers and merchants in Niles implemented the “Big Brown Take Down” to remove the Shadowform panels. By this time, Kawneer had moved its headquarters to Georgia and closed the local factory. (Fig. 8) After removal, the Governor gave the town a historic preservation award.<sup>xxiii</sup>

## 7.0 KAWNEER'S MODERNITY

The experience of modernity, to Kawneer, was synonymous with the experience of prosperity. Increased shopping was envisioned to cause increased commerce and by extension, increased profitability of townspeople. Modernization, as the process by which Kawneer believed this was to come about, was more than a function of economics. The image-making capacity of the storefronts was a visible outcome meant advertise Kawneer's products both when visitors saw the facades, but also when the facades were photographed and distributed in sales materials. Thus, Niles became a marking landscape, and the image of modernity was the visible marker of Kawneer's argument that modernization was an advantageous process.



**Figure 8** Main Street, Niles, Michigan, 2016.  
Source: Author, 2016.

Collaboration with famous architects was also an acutely strategic marketing project in image-making. Association with names such as Mies and Lescaze was a vector through which the brand could find an audience in influential trade publications and through the sponsored competitions, build brand recognition with professionals and students.

Kawneer's growth, strategies and projects in the early- and mid-twentieth century shows the extent to which manufacturers, in addition to architects, could be key drivers of architectural modernism in the United States.<sup>xxiv</sup> Rather than backwaters of modernism, small towns and Main Streets in the United States were generators of architectural modernism rooted to a range of scales. On the one end, the scale of the detail – the resilient metal window frame – facilitated a glazed storefront devoid of ornament to put merchandise on display. Kawneer took what they learned on Main Street and deployed this experience as products specified by architects on projects beyond shopping districts, even before the spread of the International Style. On the other end, the scale of the comprehensively designed shopping district perpetuated aesthetics of modernism as an image. These images were the scenes of modernism experienced by everyday Americans. Thus, it was the storefront, along with the image of other forms of modernism in the media, that formed American's experience of modernity. In addition to the role of star architects and iconic buildings, Kawneer's deployment of Niles as a testing site for modernism suggests increased scrutiny of twentieth-century manufacturers.

## REFERENCES

- "75 Kawneer Years...Only a Beginning," supplement to *Daily Star* (Niles, Michigan,) July 29, 1981.  
*Boosting Business with Kawneer Store Fronts*. Niles, Mich.: Kawneer Manufacturing Company, n.d.  
Church, Fred L. "The New Kawneer," *Modern Metals*, April 1956, pp. 1-12, Kawneer File. Citations refer to the Kawneer Company reprint.  
Cohen, Lizabeth. *A Consumers' Republic: The Politics of Mass Consumption in Postwar America*. New York: Vintage Books, 2004.  
Esperdy, Gabrielle. *Modernizing Main Street: Architecture and Consumer Culture in the New Deal*. Chicago: University of Chicago Press, 2008.  
Friedel, Robert. "The Psychology of Aluminum," working paper, 1975, Department of Science, Johns Hopkins University, Baltimore, MD., folder 2, box 51, Records of the Aluminum Company of America.  
*Kawneer Store Fronts: It Stays and Pays*. Niles, Mich.: Kawneer Manufacturing Company, 1912.  
*Machines for Selling: Modern Store Designs by Kawneer*. Niles, Michigan: Kawneer Company, 1946.  
Mumford, Lou. "Kawneer Hits Century Mark." *South Bend Tribune*, May 14, 2006.  
*Portfolio of Designs*. Niles, Mich.: The Kawneer Company, 1917.  
Sagon, Erica. "Reviving Downtown." *South Bend Tribune*, May 21, 2002, A5.  
Schatzberg, Eric. "Symbolic Culture and Technological Change: The Cultural History of Aluminum as an Industrial Material." *Enterprise & Society* 4, no. 2 (2003): 226-27.  
Shanken, Andrew M. *194X: Architecture, Planning, and Consumer Culture on the American Homefront*. Minneapolis: University of Minnesota Press, 2009.  
*The Kawneer Book of Store Fronts*. Niles, Mich.: The Company, 1936.

- 
- <sup>i</sup> Gabrielle Esperdy, *Modernizing Main Street: Architecture and Consumer Culture in the New Deal* (Chicago: University of Chicago Press, 2008).
- <sup>ii</sup> Storefront designs were explained as modern early in Kawneer's business operations. See *Kawneer Store Fronts: It Stays and Pays* (Niles, Mich.: Kawneer Manufacturing Company, 1912), 7.
- <sup>iii</sup> Quotes from *Kawneer Store Fronts: It Stays and Pays*.
- <sup>iv</sup> *Boosting Business with Kawneer Store Fronts* (Niles, Mich.: Kawneer Manufacturing Company, n.d.), p. 19, Kawneer File, Niles District Library.
- <sup>v</sup> *Portfolio of Designs* (Niles, Mich.: The Kawneer Company, 1917), 4.
- <sup>vi</sup> *Portfolio of Designs*, 4.
- <sup>vii</sup> *The Kawneer Book of Store Fronts* (Niles, Mich.: The Company, 1936), 18.
- <sup>viii</sup> *Kawneer Store Fronts: It Stays and Pays*, 5.
- <sup>ix</sup> For a retrospective of Kawneer's history, see "75 Kawneer Years...Only a Beginning," supplement to *Daily Star* (Niles, Mich.) July 29, 1981, 6.
- <sup>x</sup> For an explanation about the shifting image of aluminum, see Robert Friedel, "The Psychology of Aluminum," working paper, 1975, Department of Science, Johns Hopkins University, Baltimore, MD., folder 2, box 51, Records of the Aluminum Company of America; Eric Schatzberg, "Symbolic Culture and Technological Change: The Cultural History of Aluminum as an Industrial Material," *Enterprise & Society* 4, no. 2 (2003).
- <sup>xi</sup> "75 Kawneer Years...Only a Beginning," 10.
- <sup>xii</sup> Fred L. Church, "The New Kawneer," *Modern Metals*, April 1956, p. 2, Kawneer File, Niles District Library. Citations refer to the Kawneer Company reprint, 1.
- <sup>xiii</sup> *The Kawneer Book of Store Fronts*, 2.
- <sup>xiv</sup> Kawneer claimed a "scientific application was made" in their approach to designing storefronts. See *Boosting Business with Kawneer Store Fronts* (Niles, Mich.: Kawneer Manufacturing Company, n.d.), p. 3, Kawneer File, Niles District Library.
- <sup>xv</sup> *Boosting Business with Kawneer Store Fronts*, 18.
- <sup>xvi</sup> *Ibid.*, 6.
- <sup>xvii</sup> *The Kawneer Book of Store Fronts*, 55.
- <sup>xviii</sup> *Machines for Selling: Modern Store Designs by Kawneer* (Niles, Mich.: Kawneer Company, 1946).
- <sup>xix</sup> *Machines for Selling*.
- <sup>xx</sup> The interaction between architecture and postwar planning in the United States is explained in Andrew M. Shanken, *194X: Architecture, Planning, and Consumer Culture on the American Homefront* (Minneapolis: University of Minnesota Press, 2009).
- <sup>xxi</sup> Lizabeth Cohen argues a "complex shared commitment" between government and private industry took place after World War Two, reinforcing mass consumption. See Lizabeth Cohen, *A Consumers' Republic: The Politics of Mass Consumption in Postwar America* (New York: Vintage Books, 2004).
- <sup>xxii</sup> Lou Mumford, "Kawneer Hits Century Mark," *South Bend Tribune*, May 14, 2006.
- <sup>xxiii</sup> Erica Sagon, "Reviving Downtown," *ibid.*, May 21, 2002, A5.
- <sup>xxiv</sup> Two studies show the interaction of architectural product manufacturers and twentieth century architecture with architectural modernism. See Shanken, *194X*; Esperdy, *Modernizing Main Street*.

# From Perception to Design: Daylight Glare Mitigation in Architectural Spaces

Tasbeeh Alaqtum<sup>1</sup>, Altaf Engineer<sup>1</sup>, Colby Moeller<sup>2</sup>

<sup>1</sup>University of Arizona, Tucson, AZ

<sup>2</sup>AIA, LEED AP, Tucson, AZ

**ABSTRACT:** Daylight glare is one of the most intricate and dynamic phenomena to work with when designing architectural spaces. It has been researched across diverse fields including ophthalmology, photometry, architecture, environmental sciences, materials engineering, etc. Finding a comprehensive approach that interconnects these disciplines to inform real-world architectural practice, however, has proven elusive. Glare is defined as the excessive amount of light or high luminance ratios as perceived by the eye according to the Illuminating Engineering Society (IES 2018). Quantifying excessive light or luminance ratios, however, is challenging due to the eye's adaptability and constantly changing outdoor illumination. Daylight discomfort glare can be assessed using different methods addressed in previous research studies such as: luminance contrast ratio, daylight glare probability (DGP), vertical eye illuminance, etc. In this study, we synthesize findings through systematic literature review from ophthalmology and photometry to understand the structure of the eye and glare occurrence to assist architects and researchers conducting glare simulations. We analyze glare in an indoor space by performing various daylighting computer simulations and demonstrate how to mitigate it via different design strategies. A computer model of the space is created in Rhino and simulated in DIVA to obtain horizontal illumination data, and DGP metrics. In this study, we use a mixed methodological approach which includes selecting an existing library space and analyzing it via: (1) in-person field visits and collecting horizontal illumination data using a luminance meter, (2) performing two-level baseline simulations: [a] horizontal illuminance at 30" above finish floor level, and [b] a DGP analysis, (3) validating computer-simulated horizontal illuminations with corresponding field-measured data discussed in step 1, (5) assessing and evaluating the baseline and its glare conditions (6) proposing glare-mitigation strategies based on published studies, and (7) presenting an improved design case simulation which incorporates glare control and mitigation with daylighting strategies.

**KEYWORDS:** Daylight discomfort glare, horizontal illuminance, vertical eye illuminance, field of view, library space design

## INTRODUCTION AND RESEARCH GOALS

In the last few decades, daylighting has been approached in research and architectural practice from a building performance perspective. Daylighting strategies were utilized to reduce energy consumption; however, no proper considerations were made to occupants' visual comfort. With the widespread adoption of curtain walls in modern buildings, discomfort glare became an urgent issue, especially when windows were not shaded adequately. In response, many human-subject research studies have been conducted to develop a reliable metric for assessing daylight discomfort glare, such as those done by Wienold and Christoffersen (2006), Osterhaus (2005), and Velds (2002). Daylight glare probability (DGP), which was developed by Wienold and Christoffersen (2006), is the latest and most reliable glare rating under daylighting conditions according to Suk, Schiler and Kensek (2017). The rating spans from 0% to 100%, and can be classified into four categories: imperceptible (0-35%), perceptible (35-40%), disturbing (40-45%), and intolerable (45-100%). DGP's score represents the number of people who were not satisfied in the initial experiment. We, therefore, adopt the guideline developed by Wienold and Christoffersen in this paper, and define daylight discomfort glare as any daylight glare that occurs in indoor spaces causing the eye's discomfort and has rating of perceptible or higher on the DGP scale, i.e. DGP is 35% or higher. As a result, DIVA plugin based upon the DGP metric was selected for simulation. DIVA, developed by the Graduate School of Design at Harvard, is a reliable and validated tool that utilizes a user-friendly interface without the need for writing programming code. It links validated performance simulation engines to Rhino such as: Radiance, Daysim, Evalglare, and EnergyPlus. These engines were previously validated in research studies such as: (Mardaljevic 1995), and (Reinhart and Walkenhorst 2001). We also highlight the importance of expanding the definition of adequate daylighting to include glare mitigation strategies and controls in addition to implementing daylighting strategies. We conduct field measurements of horizontal illuminance data to get a good idea of existing daylighting conditions in the space, and validate this measured data with the horizontal illuminance data from the computer model. The validation ensured that lighting distribution in the computer model is close to the real situation, while the horizontal illuminance data allows for assessment of the overall daylighting condition. After validation, we rely only on computer simulations to assess glare. We also include summaries on daylight glare in medical and engineering disciplines and discuss how they may inform architectural practice.



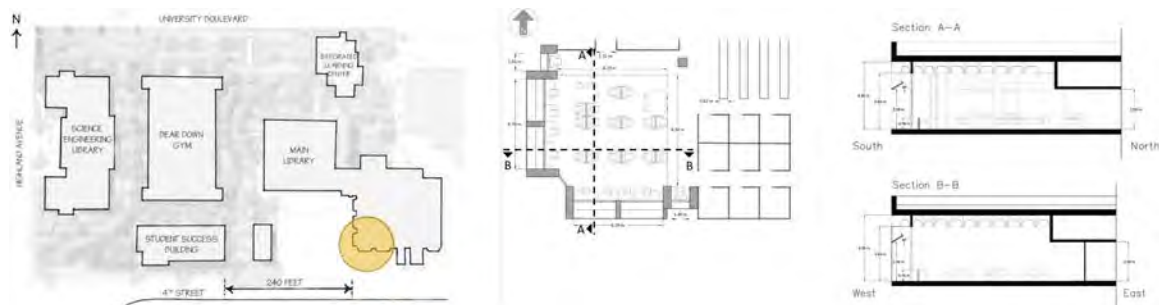
Adequate daylighting in spaces has proved to be beneficial for occupants' health and wellbeing. Research has shown that adequate daylighting decreases employees' eyestrain, headaches, and other vision-related symptoms in office spaces. Experiments by Hedge (2018) revealed that occupants seated within 10 feet of a window could experience 84% decrease in eyestrains given the fact that windows do not have glare. Brainard, et al. (2015), and Wright Jr, et al. (2013) showed that proper daylighting exposure and connections with outdoor environments through windows are essential for maintaining natural circadian rhythms. Daylighting can also reduce energy consumption in buildings. Gordon (2012) found that providing schools with sufficient daylighting and eliminating glare contributed to an annual energy reduction of 24% in Los Angeles. Research by Ihm, Nemri and Krarti (2009) showed that annual energy savings of up to 60% are achievable if daylighting strategies are utilized. In addition, the U.S. EPA's greenhouse gas equivalencies calculator (2020) revealed that one kilo-watt-hour savings of energy consumption in buildings can save 707 grams of carbon dioxide presuming the energy is originally generated from non-renewable resources.

Literature review findings revealed how we perceive, interpret and simulate glare. The human eye can receive and adapt to a wide range of illumination between 0.01 -10,000 lux, and luminance values between one-micron to one-hundred billion cd/m<sup>2</sup> (Kunkel, et al. 2016 and Damberg, et al. 2007). At any given time, however, the eye can only operate under a fraction of this enormous range. The eye's retina contains two photoreceptors: rods and cones that operate optimally under nighttime conditions and daylighting conditions, respectively. Cones are less numerous than rods while rods are extremely sensitive to light to facilitate vision in dark environments. Thus, it is important to consider whether a daylighting design is for workplaces, photographing, or for low-illuminated environments. Further, the human eye is more tolerable to glare resulting from daylight when compared to artificial lighting. Suk (2019) summarized the acceptable thresholds of different metrics linked to glare. Any surface's luminance in an indoor scene should not exceed 2420 cd/m<sup>2</sup>, and vertical illuminance at the eye's position should not exceed 1250 lux from a human comfort and performance perspective. The same study recommends the maximum contrast ratio between the luminance of the task area and the glare source to be 1 to 11.7. Our study utilizes this contrast ratio as an optimal setting in our design recommendations which is equivalent to a DGP threshold of 35% or higher to define daylight discomfort glare in simulations as mentioned previously, and the IESNA Lighting Handbook (2000) threshold of acceptable horizontal illuminance of 300-500 lux at the desk level in library spaces. We present only the DGP results since it is more comprehensive and already covers the contrast ratio method.

## 1.0 METHODS AND DATA COLLECTION

### 1.1. Case study location and existing design

A reading room in the University of Arizona Main Library located in Tucson, AZ was selected for a case study. Tucson is part of the Sonoran Desert, a hot-arid region which extends across the U.S and Mexico. The library building is composed of one floor level below grade, and four floors above, with views to surrounding mountains, adjacent campus buildings and outdoor landscape that can be seen from the top floors. The selected space is a reading room on the top floor in the southwest corner as shown in **Figure 1**. Its west elevation is 73m (240'-0") away to the east from an adjacent building. The space is 8.2m (27'-0") wide and 8.3m (27'-3") long with fixed seating spaces for 32 people. It has a clear height of 4.4m (14'-5") measured from the finish floor level to the bottom of the ceiling waffles. It contains existing overhangs on the south and west windows tilted at 30°. The windows have a clear height of 3.6m (11'-11") from the finished floor.

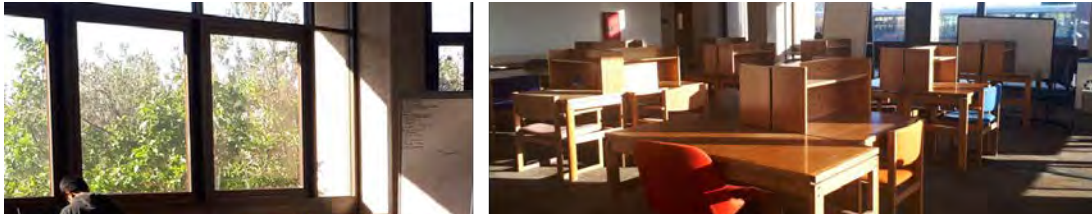


**Figure 1:** Location of the library space (left), interior floor plan (middle), and sectional drawings (right). Source: authors.

### 1.2. Field observations

Field visits were carried out on different days over the year and different times of the day to document a variety of glare scenarios. Selected photographs of these glare conditions are shown in **Figure 2**. We noticed that students were sitting close to windows to be closer to the outside views or for more privacy while studying. During several occasions, direct sunlight penetrated deeply into the space. It was observed coming from the south window during the winter months (September through February) in the morning hours, and throughout the year from the west window in the afternoon hours. These observations indicate that if the sun's altitude angle is low, it would enter the space directly through the

windows and cause discomfort. Further discussions of glare with sketches are included in section 2.3. Sunlight was found to create very bright environments either by rendering high light intensities on horizontal reading surfaces, or by causing luminance levels at windows to exceed the acceptable threshold for visual comfort. Horizontal illuminance on the desk level under direct sunlight can vary from a few thousand to tens of thousands lux despite the fact that 1000 lux is the maximum acceptable horizontal illuminance threshold according to the method published by the Illuminating Engineering Society (LM 2013). The maximum acceptable vertical eye illuminance is 1250 lux (as discussed earlier). Vertical eye illuminance with direct sunlight in the field of view could be up to tens of thousands of lux which inherently generates glare regardless of the contrast ratios of the scene. This glare situation happens due to the high luminance value of the sunlit desks that dominate the impact of contrast ratio (Suk, Schiler and Kensek 2013).



**Figure 2:** Photographs of the reading space showing excessive glare conditions at windows and desk surfaces on Feb. 14, 2020 at 09:50 a.m. (left), and on Jan. 31, 2020 at 05:00 p.m. (right). Source: authors.

### 1.3. Field measurements for horizontal illuminance

Field measurements were conducted to collect horizontal illuminance data in order to have an overall understanding of the daylit environment of the space and to validate the horizontal illuminances data that will be obtained from the simulation process described in later sections. This method is cost and time-effective utilizing simple hand tools when compared to luminance measurements that need CCD cameras and other potentially expensive technology. The horizontal illuminance intensities were captured on March 17<sup>th</sup>, 2020 at height of 30" (the work surface height) above the finish floor level, as shown in **Figure 3**. The measurements were collected at four different times that same day: 9:00 a.m., 12:00 p.m., 3:00 p.m., and 5:00 p.m. They were conducted manually with a digital luxmeter shown in figure 3, with an error percentage of 5%. We took measurements under clear sky conditions since Tucson has clear skies for more than 75% of the year on average. The luminance (lux) meter is composed of a photo sensor and data reader, which was attached on a 1m (40") wood bar to minimize interference from the person holding it and the photo sensor. The sensor readings were taken on a grid of 1m (40") by 1m (40") which is equivalent to 2 of the carpet tiles installed in the space. Measurements were taken from the southeast corner moving towards the west in the same row, and then moving from one row to the other, i.e. one block to the north, until the northeast corner of the space was reached.

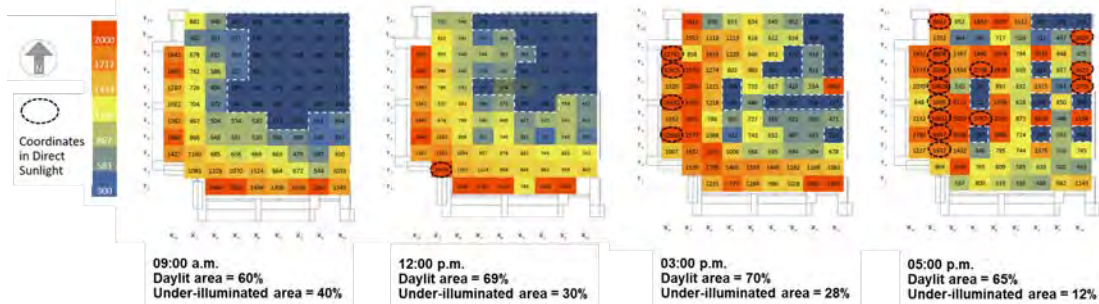


**Figure 3:** From left to right: Floor plan showing grid of measurement locations; partial sectional drawing showing height of measurements at the work surface level; light-meter tool used to measure illuminance; light meter with extension rod for sensor; light meter with extension rod held 30 inches above the floor finish. Source: authors.

### 1.4. Assessment of horizontal illuminance levels

All the horizontal illumination measurements taken on site on March 17, 2020, are presented in **Figure 4**. A color scale is assigned to the readings, with red representing illumination levels of 2000 lux or more, and blue representing illumination levels 300 lux or below. The baseline used for recommended light intensities rendered on the desk level were taken from the IES code requirement of 300-500 lux. The under-illuminated areas i.e., ones with illumination levels of less than 300 lux, are shown outlined with dashed polygons and represented in darker blue. The daylit area is any area achieving the minimum requirement of 300 lux or more. The dotted ellipses represent the areas of direct sunlight observed in the space. We observed the extent of under-illuminated areas to be higher in the morning hours since there were no east-facing windows. Excessive direct sunlight was found in the afternoon hours, in areas close to the west windows. Importantly during these hours, there was a combination of about 25% under-illuminated areas as well as direct sunlight. These observations and measurements showed contrasts in horizontal illuminations between adjacent sensor points, which were most likely an indication of daylight inadequacy, i.e., daylighting discomfort glare was occurring at these times as pointed out by Karlsen, et al. (2015). Karlsen's study showed a strong correlation between horizontal illuminance at desk level and occupants' perception of glare.





**Figure 4:** Measured horizontal illuminance at 30" above the finish floor level at 4 different times on the day of Mar. 17th, 2020 at 9:00 a.m., 12:00 p.m., 3:00 p.m., 5:00 p.m. (left-to-right). Source: authors.

## 2.0. DAYLIGHTING SIMULATIONS

### 2.1 Simulation method

We evaluated the baseline daylighting scenario by creating a 3d model of the existing space in Rhino and conducting daylighting analysis utilizing the DIVA software plugin. The model was based on architectural drawings of the space from the University of Arizona's Planning, Design & Construction office. Model elements were assigned to different layers with each layer representing a specific material defined in DIVA's material library to match the real finishes in the space. The light reflecting factors for opaque materials and light visible transmittance of glazing were obtained from the Engineering Toolbox website (Toolbox 2001), and entered into the material setting tool in DIVA, as illustrated in **Table 1**.

**Table 1:** Light reflecting factors for opaque material finishes and visible light transmittance for glazing in DIVA for the daylighting analysis simulation. Source: (Toolbox 2001).

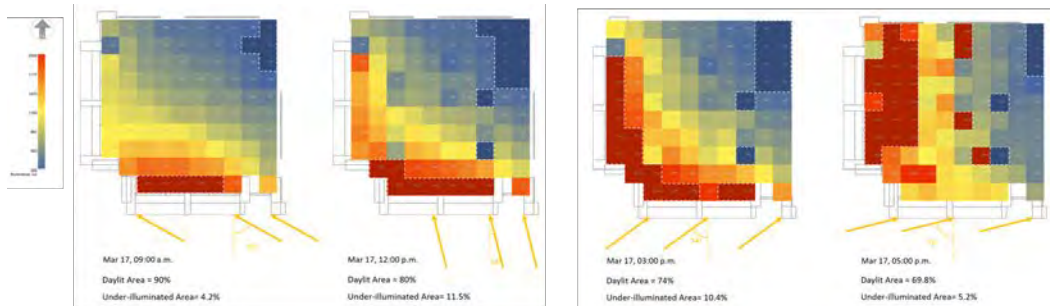
Layer	Assigned material in DIVA library	Lighting reflecting factor (%)	Layer	Assigned material in DIVA library	Lighting reflecting factor (%)	Visible light transmittance (%)
1. Building roof	Generic ceiling	80%	6. Window glazing	Transparent black tinted	-	65%
2. Interior ceiling (waffle blocks)	Concrete	70%	7. Window framing	Platinum aluminium	48%	-
3. Secondary ceiling (dropped)	Light grey glossy painted	75%	8. Furniture-tabletops and chairs	Light cherry oak wood	50%	-
4. Columns	Rough concrete	40%	9. Adjacent buildings	Red brick walls	15%	-
5. Floor	Dark grey carpet tiling 20"X20"	10%				

Two-level simulations were conducted to assess the daylighting design of the space and presence of glare. We started by simulating horizontal illuminance data and correlating the simulated data with the corresponding measurements. Finally, an advanced-analysis of point-in-time glare for the west and south windows was conducted. Results from computer simulations, field visit observations, and field measurements are presented and discussed in the next section.

## 2.2. Results and discussion

### 2.2.1 Simulations of horizontal illuminance measurements

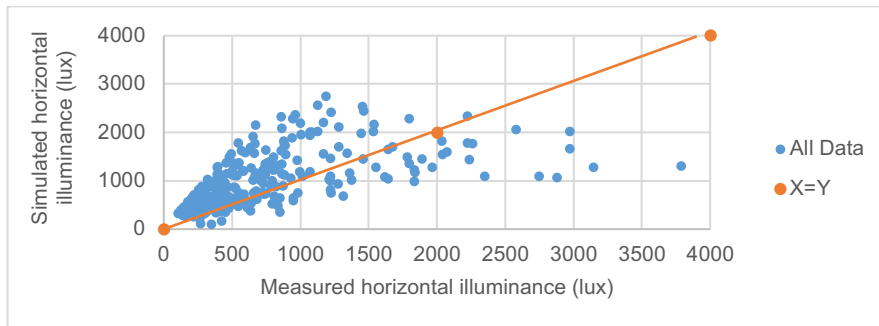
We input the proper weather data file, assign a grid of 1m by 1m nodes of sensor points at 0.76m (desk level), input materials' reflections and glass's visible transmittance, and pick Mar. 17<sup>th</sup> on the four mentioned times of measurements: 09:00 a.m., 12:00 p.m., 03:00 p.m., and 05:00 p.m. Horizontal illuminance simulations were conducted, and the results are shown in **Figure 5**. Red-to-blue color scale is assigned for the illuminations from 2000-300 lux. The dotted polygons refer to either the under illuminated areas of less than 300 lux with dark blue color, or the over illuminated areas of more than 2000 lux with dark red color. Notice that the sun angle for each time of the day matches the color gradation from red to blue which in turn reflects the pattern of overall daylighting distribution and direct sunlight exposure in the simulations. The lighting pattern distributions between the measured data (previously presented in **Figure 4**), and the simulated data below in **Figure 5** are compared to validate the simulation results as described below.



**Figure 5:** Simulated horizontal illuminance at 0.76m (30") above the finish floor level at 4 different times on the day of Mar. 17th, 2020 using Rhino and DIVA software, namely 09:00 a.m., 12:00 p.m., 03:00 p.m., 05:00 p.m. (left-to-right). Source: authors.

### 2.2.2. Validation of simulation-generated horizontal illumination levels

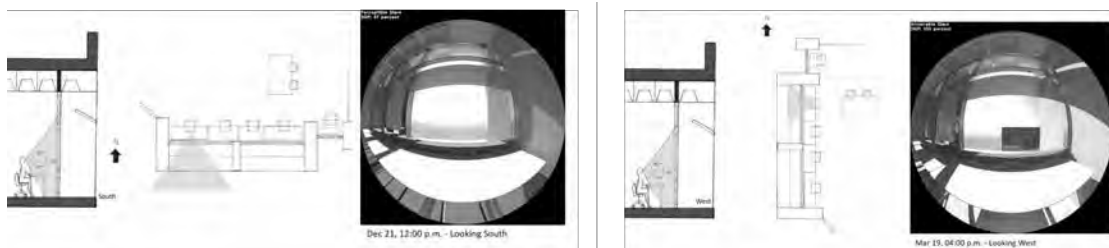
In **Figure 6**, we validate the horizontal illuminance simulations with a Pearson's correlation of the light horizontal illuminations for measured vs. simulated data. In the figure, X=Y line represents Pearson's R-value of 1, which means that measured data exactly matches simulated data. The calculated R-value of our data is 0.84 which demonstrates a strong correlation. For most of the measured data, *i.e.*, 0-1000 lux, we notice that measured and simulated data are consistent. We notice a few extreme outliers in the range above 2500 lux. These samples were located under direct sunlight which explains their inconsistency.



**Figure 6:** Measured vs. simulated horizontal illuminance data on Mar.17, 2020 at 09:00 a.m., 12:00 p.m., 03:00 p.m., and 05:00 p.m. Source: authors.

### 2.2.3. DGP analysis simulations

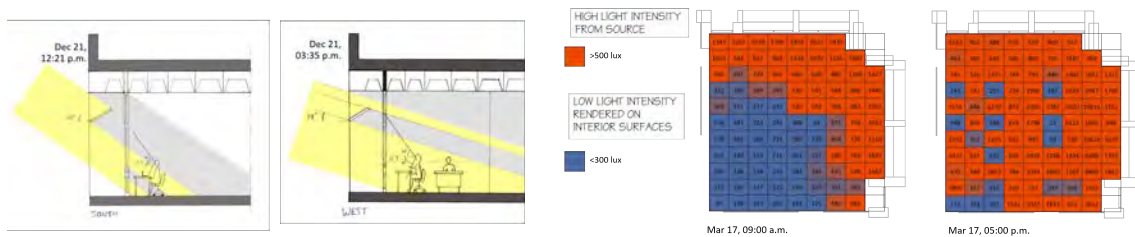
Advanced simulation analysis of daylight glare was performed by using two fish-eye cameras in DIVA, with each one placed in the position of a seated human with a line-of-sight 15° below the horizontal line. Each camera is placed at 0.81m (2'-8") distance from the window to account for the maximum daylight glare situation that was observed in the space. In **Figure 7**, we show schematic drawings of each camera's location and the point-in-time glare analysis result. In the south camera, daylight glare is observed as perceptible with an excessive amount of sunlight rendered on the tabletops close to the windows. This situation is very similar to the one documented on Feb. 14, 2020 at 09:50 a.m. in person and shown previously in **Figure 2**. For the west camera, daylight glare is observed as intolerable, with the presence of the sun in the field of view. Unfortunately, the building located to the west of the main library building does not block any of the sunlight observed in this space.



**Figure 7:** Camera selection points on the south and west facades shown in sectional elevation (first image on the left and fourth image from the left) and plan (second and fifth images from the left), and initial DGP simulations (third image from left, and last image on the right). Source: authors.

### 2.3. Space challenges and study limitations

The daylighting analyses discussed in previous sections reveal the main daylighting challenges in the space to be the direct sunlight penetrating the space at different hours, and resulting high contrast ratios in light intensities rendered on horizontal and vertical surfaces. **Figure 8** illustrates how direct sunlight is present in the field of view while sitting close to the windows. Windows have large variations in their luminance values at sunny portions versus shaded portions creating the presence of relative glare, i.e., daylight glare happening due to the contrast ratios between the glare source (window) and the background. Moreover, direct sunlight in the field of view causes excessive brightness, leading to an absolute glare situation as defined by Suk, Schiler and Kensek (2013). The (improper) design of shading devices on west and south appears to be the biggest contributor to the problem. The existing overhang of 30° tilting angle can fully shade the south window only if the sun altitude angle is 63° or higher, i.e., it can only shade windows from April to October. During the rest of the year, however, the existing south overhang does not provide any form of shade. The shading condition on the west-side is even worse. The overhang does not provide any shade throughout the year since the altitude angles of the sun from the west are always less than 48°. Vertical shading devices are needed, therefore, to counter the low sun angles and maintain a view. Another problem is that most of the space is either over-illuminated or under-illuminated as shown by the measured horizontal illuminations as explained in **Figure 8**. The areas with 2000 lux illumination or higher are shown in red and areas with 300 lux or less are shown in blue. Mixed red and blue color is assigned to the few daylighted areas that have illumination levels in the recommended range of 300-500 lux. In conclusion, the daylighting environment in the existing library space does not satisfy horizontal illumination distribution requirements for most of the year, and it frequently shows a strong presence of daylight glare at different times of the year.



**Figure 8:** Challenges of the daylighting situation in the space, daylight glare presence due to the variations in windows' luminance values at sunny portions versus shaded portions (first and second images from left), under-illuminated areas <300 lux (third image from left), and over-illuminated areas >500 lux (last image on the right). Source: authors.

### 3.0. DESIGN RECOMMENDATIONS AND FUTURE RESEARCH DIRECTIONS

The findings of this study reveal the need to re-design shading devices and account for the solar angles, orientation, and the climate of the Tucson area in order to block direct sunlight. Additionally, there is a need to augment daylighting levels in the back of the space. The combination of side and top daylighting strategies was proposed to balance out the lighting levels. This solution eliminates the issues of high light intensities on the surfaces close to the light source (windows) and the low light intensities on the surfaces at the back of the space. In the next two sections we elaborate more on the proposal and the improvements.

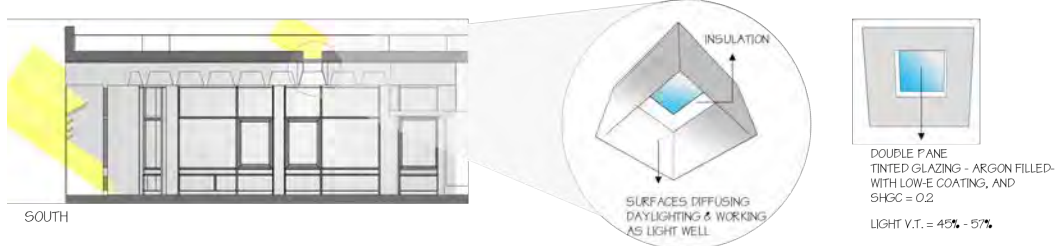
#### 3.1. Recommended strategies

The existing daylighting scenario presents the following challenges: (1) direct exposure to sunlight close to windows, (2) high light intensities rendered on desk surfaces close to windows, i.e., *over-illuminated areas*, and (3) low light intensities rendered on the surfaces at the back of the space, i.e., *under-illuminated areas*. These low light intensities occur because of the relatively large dimensions of the floor plate -- 8.2m (26'-10") wide by 8.3m (27'-3") long -- which makes it very hard for the windows to illuminate the entire space. Therefore, the design strategies that mitigate daylight glare and transmit or reflect some daylight to the back should include the following considerations: (1) strategies to block direct sunlight, (2) strategies to reduce high luminance levels close to the source, and (3) strategies to augment daylighting away from the source. Based on previous studies and built examples mentioned in Lechner's book (2014) and Freewan's research study (2014), proper shading devices informed by solar angle calculations could accomplish the first two goals, while skylights could accomplish the third goal resulting in a mitigation of discomfort glare.

#### 3.2. Final design proposal and future work

The final design proposes adding stepped louvers that are parallel to the existing overhang on the south window as shown in **Figure 9**. They can also work as light shelves if their bottom surfaces are coated with light reflective color to bounce daylight further from the window. Thin vertical louvers spaced to block the variable horizontal component of the sun in afternoon hours are proposed on the west façade to help in mitigating glare. Additionally, multiple distributed skylights are proposed to address the low illumination levels. Their design allows daylighting while blocking sunlight. To address thermal performance, which is beyond the scope of this paper, they will use double pane tinted glazing with argon fill and low-e coatings to allow for thermal insulation since the building is in a hot region. They can be added to

the top of waffle-shaped ceiling profiles (as shown in figure 9) which would allow them to work as pyramidal shaped light wells to diffuse and soften the daylighting quality and ambience. Finally, we present daylighting improvements in this proposal via DGP analysis in **Table 2**. The DGP values for the proposed design were significantly reduced from the base conditions discomfort glare levels previously discussed in the introduction. In this design proposal, our assumption is that the windows would have a much-reduced, imperceptible, daylight glare, i.e.,  $DGP < 35\%$ . In future research, our goal is to conduct a series of computer simulations to validate these design recommendations and simplify the implementation to aid with the design process in architectural offices. Another level of analysis would include energy consumption as an additional metric for proposed design improvements, and provide daylight spaces with views to the outdoors with limited glare and considering a factor of reality (FR) as mentioned in (Elzeyadi and Abboushi 2019).



**Figure 9:** Sketch of the design case proposal showing the use of shading devices and skylights. Source: authors.

**Table 2:** Point-in-time glare analysis simulations in the base-case (first and second columns from left) and the design case (third and fourth columns from left) considering two different window orientations. Source: authors.

Baseline Scenario		Designcase Scenario	
South-oriented window	West-oriented window	South-oriented window	West-oriented window
DGP= 0.37, perceptible	DGP= 1.00, intolerable	DGP= 0.30, imperceptible	DGP= 0.25, imperceptible

## CONCLUSIONS

This study highlights the most important lessons learned from an interdisciplinary perspective on the topic of daylight discomfort glare. It summarizes the key findings from a mixed-method approach and applies them to an existing library space. The study, thereafter, incorporates these findings into the space, demonstrating a simplified and effective approach to mitigate daylight glare for practitioners and researchers. In the design recommendations, the importance of using a combination of daylighting strategies that can balance out the daylighting design of a space is emphasized. The key findings of this study are:

- Direct sunlight is problematic in workspaces. It creates visual discomfort due to the high illumination rendered at the desk level and the high contrast it creates in the field of view, especially in specific climate regions where clear skies are prevalent most of the year
- Daylight adequacy includes not only the avoidance of daylight glare in spaces but also the even distribution of horizontal illuminations considering contrast and brightness ratios
- Combinations of appropriate side daylighting and top daylighting design strategies with the aid of computer simulation tools should be optimized to create good daylighting solutions which mitigate glare

## ACKNOWLEDGEMENTS

The authors would like to acknowledge the support of University of Arizona Libraries in conducting this research study on their premises.

## REFERENCES

- Brainard, J., Gobel, M., Scott, B., Koeppen, M., and Eckle, T. 2015 "Health implications of disrupted circadian rhythms and the potential for daylight as therapy." *Anesthesiology: The Journal of the American Society of Anesthesiologists* 122, no. 5, 1170-1175.
- Damberg, G., Seetzen, H., Ward, G., Heidrich, W. and Whitehead, L. 2007, May. "3.2: High dynamic range projection systems." *SID Symposium Digest of Technical Papers* 38, (1): 4-7.
- Elzeyadi, IMK., and Abboushi, B. 2019. "Daylighting Performance in Schools between Simulation Predictions and Field Verifications." *The 16th IBPSA Conference*. Rome: IBPSA 4361-4368.

- Freewan, AAY. 2014 "Impact of external shading devices on thermal and daylighting performance of offices in hot climate regions." *Solar Energy* 102 - Elsevier 14-30.
- Gordon, S. 2012. consulting - specifying engineer. Accessed May 5, 2020. <https://www.csemag.com/articles/school-is-in-session/>.
- Hedge, A. 2018. PR Newswire. "Natural Light Is the Best Medicine for the Office." 31 Jan. Accessed Dec 20, 2020. <https://www.prnewswire.com/news-releases/study-natural-light-is-the-best-medicine-for-the-office-300590905.html>.
- IES. 2018. *Illuminating Engineering Society* . 5 Jul. Accessed Dec 21, 2020.
- Ihm, P., Nemri, A., and Krarti, M. 2009. "Estimation of lighting energy savings from daylighting." *Building and Environment* 44, no. 3 - Elsevier 509-514.
- Karlsen, L., Heiselberg, P., Bryn, I., and Johra, H. 2015. "Verification of simple illuminance based measures for indication of discomfort glare from windows." *Building and Environment* 92 615-626.
- Kunkel, T., Daly, S., Miller, S., and Froehlich, J. 2016. "Chapter 15 - Perceptual Design for High Dynamic Range Systems." In *High Dynamic Range Video - From Acquisition to Display and Applications*, 391-430. San Francisco : Academic Press.
- Lechner, N. 2014. *Heating, cooling, lighting: Sustainable design methods for architects*. John Wiley & Sons.
- LM, IES. 2013. "Approved method: IES spatial Daylight autonomy (sDA) and annual sunlight exposure (ASE)."
- Mardaljevic, J. 1995. "Validation of a lighting simulation program under real sky conditions." *International Journal of Lighting Research and Technology* 27, no. 4: 181-188.
- Office, US Department of Energy Building Technologies. "EnergyPlus Weather Data." 2020. <https://energyplus.net/weather> (accessed Nov 17, 2020).
- Osterhaus, WKE. 2005. "Discomfort glare assessment and prevention for daylight applications in office environments." *Solar Energy - Elsevier* 140-158.
- Rea, MS. 2000. *IESNA Lighting Handbook*.
- Reinhart, CF., and Walkenhorst, O. 2001 "Validation of dynamic RADIANCE-based daylight simulations for a test office with external blinds." *Energy and buildings* 33, no. 7: 683-697.
- Suk, JY. 2019. "Luminance and vertical eye illuminance thresholds for occupants' visual comfort in daylit office environments." *Building and Environment - Elsevier* 148: 107-115.
- Suk, JY., Schiler, M., and Kensek, K. 2013. "Development of new daylight glare analysis methodology using absolute glare factor and relative glare factor." *Energy and Buildings* 64- Elsevier 113-122.
- Suk, JY., Schiler, M., and Kensek, K. 2017. "Investigation of existing discomfort glare indices using human subject." *Building and Environment - Elsevier* 113: 121-130.
- Toolbox, Engineering. *The Engineering Toolbox*. 2001. [https://www.engineeringtoolbox.com/light-material-reflecting-factor-d\\_1842.html](https://www.engineeringtoolbox.com/light-material-reflecting-factor-d_1842.html) (accessed May 21, 2020).
- US-EPA. United States Environmental Protection Agency. 2020. <https://www.epa.gov/energy/greenhouse-gas-equivalencies-calculator> (accessed May 5, 2020).
- Velds, M. 2002. "User acceptance studies to evaluate discomfort glare in daylit rooms." *Solar Energy - Elsevier* 95-103.
- Wienold, J., and Christoffersen, J. 2006. "Evaluation methods and development of a new glare prediction model for daylight environments with the use of CCD cameras." *Energy and Buildings* 38 (7): 743-757.
- Wright Jr, KP., McHill, AW., Birks, BR., Griffin, BR., Rusterholz, T., and Chinoy, ED. 2013. "Entrainment of the human circadian clock to the natural light-dark cycle." *Current Biology* 23, no. 16 1554-1558.



# Model Calibration for Circadian Daylighting in ALFA: Developing Empirical Circadian Predictions in Physical Scaled Model

Sara Sahebghalam<sup>1</sup>, Adil Sharag-Eldin<sup>1</sup>

<sup>1</sup>Kent State University, Kent, OH

**ABSTRACT:** Daylight as an important element of sustainability, has a strong impact on human health and well-being. Many studies showed that with access to natural light in the space, the occupants' mood and performance are improved. This is related to human responses to multi-spectral characteristics of daylight and referred as non-visual effects. These effects play an important role in adjustment of the circadian system, sleep quality and alertness levels. This study utilizes a computational tool called Adaptive Lighting for Alertness (ALFA), a plug-in for rhinoceros that can calculate both visual and non-visual effects within a 3D model to predict circadian potential of daylight. To reduce prediction errors, a physical scaled model was built and tested under overcast sky to calibrate simulation model for real conditions. The quantitative Daylight Factor (DF) results of the physical model dataset for a point-in-time measurement are presented in depth and compared with results of 3D model simulation. The conclusions substantially indicate that the ALFA simulation software predicts the levels of daylight in line with outcome of on-site measurement in physical model with 98.89 percent correlation. The prediction result of the software is slightly marginal under-predicts the levels of daylight with 1.0536 calibration coefficient due to some material mismatch in real-world on-site simulation conditions and software simulation settings.

Additionally, this paper examines if physical models can be used for daylight circadian potential predictions while in design stage. For this purpose, the concept of linear regression was adopted to predict the non-visual to visual effects ratio by using the basic information of field measurement such as daylight factor. The simulation results verified that the average absolute relative error is less than %3, which is acceptable in real-world application. In future studies, validation on other parameters can be performed, such as other sky conditions, various window configuration and orientation, to add this consideration in daylighting pre-design evaluation.

**KEYWORDS:** adaptive lighting for alertness (ALFA), physical model, calibration, daylight factor, circadian lighting

## INTRODUCTION

The way buildings are designed has an enormous impact on occupant exposure to daylight (Boubekri, Cheung, Reid, Wang, & Zee, 2014). Simulation tools play a crucial role in appropriate daylight design to assess the illumination system applications in the built environment prior to make informed decisions around window openings, shading and fenestration. Since circadian response of humans to light is dependent on the light that enters the eye, factors such as spectral properties of the light, brightness levels, duration, and timing of exposure should be considered. The light levels must be achieved on the vertical plane, at the eye level of the occupant to simulate the light entering the eye of the user (Lockley, Arendt, & Skene, 2016). Current tools are mainly focused on the intensity levels and availability of daylight in the space with no direct consideration of effects of daylight on occupants' circadian system. Exposure to daylight has been proven to have a substantial impact on mood, circadian health and productivity (Amundadottir, Rockcastle, Sarey Khanie, & Andersen, 2017).

In addition to the required quantity of light for vision, the human body clock and circadian rhythm is affected by the non-visual effects of light. The discovery of a new photoreceptor, intrinsically photoreceptive retinal ganglion cells (ipRGCs), raises the possibility that the spectral sensitivity of non-image-forming (NIF) responses could be fairly different from that of rod- or cone-based vision (Lucas et al., 2014). The human circadian system is most sensitive to light spectrum at 460nm (blue region of the visible light spectrum) and measured as Equivalent Melanopic Lux (EML). On the other hand, the visual system is most sensitive to 555nm (green region of the visible light spectrum), (Brainard et al., 2001), (Rea, Figueiro, Bierman, & Bullough, 2010), (Thapan, Arendt, & Skene, 2001) measured as photopic lux that can be calculated directly by measuring the illuminance of a scene. The photopic luminous efficiency function is actually only one of a wide variety of functions that can be used to characterize the spectral sensitivity of the human visual system. Depending upon the experimental conditions, many spectral response functions can be obtained from the human visual system (Rea et al., 2010). Both Melanopic and photopic are spectral weighting function for non-image-forming

responses (Lucas et al., 2014). The EML measurement offers an estimation of the light that adjusts human body clock for sleep-wake; therefore, influence sleep quality and alertness, while photopic lux evaluates the amount of visual comfort. Based on studies conducted by Berman, it is possible, over a wide range of conditions, to describe the sensitivity of the biophysical response as a function of the photopic light level multiplied by a level-independent spectral weighting factor that is a function of a ratio of melanopic/photopic (M/P) outputs (Berman, 2008). The M/P value is a light property associated with the Spectral Power Density (SPD) and is independent of overall intensity level to the extent that the SPD does not vary with level. The M/P ratio is also useful in its own right for some applications as it provides an estimate of the relative efficiency of different sources at producing a melanopic stimulus at a fixed photopic output, thus providing an immediate path for application in the absence of a melanopic meter (Berman & Clear, 2019).

International WELL Building Institute (IWIB) is the only certification that monitors the impact of light on health and well-being for the use of both electrical and daylighting. One of its preconditions for certification is sufficient melanopic light intensity entitled as *Circadian Lighting Design L03* in the space with combined thresholds for enhanced daylight access under *Daylight Design Strategies L05*, *Daylight Simulation L06*, for visual comfort and glare control considerations. The compliance can be achieved through the use of both electrical lighting and daylighting to meet such requirements. Nevertheless, daylight should be used to the extent possible and supplement insufficiently-daylit zones with appropriate electrical lighting. In a study by Konis, a metric was suggested through various simulation models specifically for daylight and this knowledge of non-visual effects of light during design will help designers to better evaluate and improve the circadian effectiveness of various daylighting strategies (Konis, 2017).

A new simulation tool has been developed by *Solemma* called Adaptive Lighting for Alertness (ALFA) to calculate circadian lighting and melanopic response in accordance to WELL. Unlike most daylighting analysis tools that use either mathematical or CIE sky models, ALFA develops spectral calculation by using physically accurate spectral skies and material. ALFA performs simulation by assigning spectral properties through its built-in library to Rhinoceros 3D model and extended the Radiance lighting engine to render the world in high-resolution, 81-color spectra (Konis, 2019). Spectral raytracing allows ALFA to predict the amount of light absorbed by an observer's non-visual photoreceptors, with a given location and direction of view. It generates daylight modeling through accurate skies using the radiative transfer library libRadtran. This lets ALFA users pull up physically accurate clear, hazy, or overcast skies for any location on the earth. Additional to Melanopic Lux levels it produces photopic and the ratio of Melanopic/Photopic (M/P) which is defined as Alertness. Simultaneously, visual comfort can be evaluated by the 180° fisheye sensors placed on a vertical plane to predict amount of visual comfort along with the amount of work plane illuminance. Alertness potential can be evaluated as if blue enriched (M/P>90), blue depleted (M/P<0.35) and neither (0.35<M/P<0.9) by percentage of the locations ("Solemma- ALFA," 2019).

A significant aspect of daylight simulation is the representation of real sky conditions in mathematical modeling. Hence, one would be expecting a large margin of error when comparing physical model measurement to prediction if a realistic sky conditions are not included. Physical models may be used as tools for calibration of real conditions. Based on the physics of illumination, light behaves closely the same way in a scaled model as it does in a full-scale building. According to Love and Navvab results, the general estimation of daylighting performance in physical models differed by 10 – 50% from that of the real building (full-scale space) depending on the fenestration types and photometer position in the space (Love J.A., Navvab M., 1991).

However, and due to the continuous changes in the light levels, another metric is needed. The ratio of horizontal illuminance at any point to the that measured outdoors remains constant regardless of the light levels outdoors. This ratio is relatively stable because it is a function of the geometry of the room, reflectivity of the surfaces, window location, and proximity to the point of interest. The Illuminating Engineering Society of North America (IESNA) defines this ratio as Daylight Factor. The ratio takes into account the luminous flux from the sky but not sunlight) and is generally used with uniform or under International Commission on Illumination (Commission Internationale de Eclairage, CIE) CIE overcast skies (*Norsk IPR : Norwegian Green Building Council Internasjonal IPR : BRE Global*, 2012). DF method within physical models has been well established between designers, engineers, scientists to calibrate simulation model with a physical model. Like calibration and validation methods, a series of tasks is required to verify software specifications and measure their accuracy. Validation is the overall process of comparing the model and its behavior to the real physical system, while calibration is the iterative process of comparing the model to the real physical system and making adjustments. Depending on the risks involved with the precision and on the functions performed by the program various approaches are introduced.

## 1.0. METHODOLOGY

This study is comparing daylight levels within the physical model of a hypothetical classroom with a simulation model. Results of this comparison would suggest an error factor for calibration purposes and this factor can be used for further extended simulation models and non-visual potential and predictions.



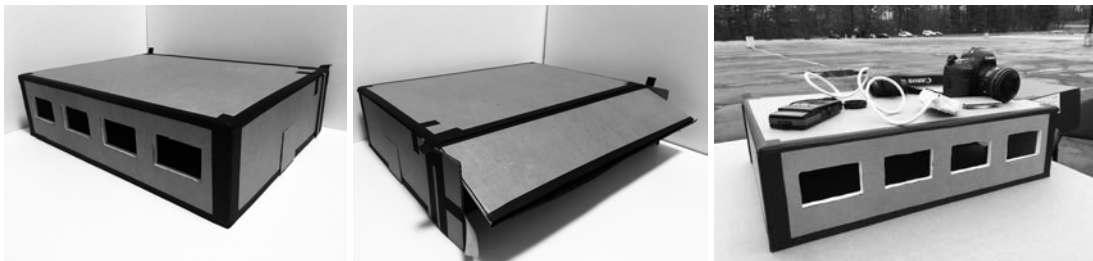
### 1.1. Physical Scale Model Study

A1:20 scaled model for 9m X 12m X 3.2m classroom of 20 students was built. All dimensions were selected according to standard classroom envelope dimensions (Tanner, 2009). The window opening was calculated according to the minimum window to wall ratio of 25% required for school classrooms to meet the minimum daylight factor for classrooms as 2% (Baker N, 2014), divided into four openings through the south wall.

The model was constructed from opaque material measured for light reflectance values shown in (Table 1). For measuring the light reflectance of the model finishes, Equation (1) was applied, considering that the opaque finish layers reflect light equally in all directions, in other words, as a Lambertian diffuser. Where L is the mean luminance of three measured spots measured by Minolta Luminance meter LS-1500 and E is the average of three illuminance spots gathered through Minolta Illuminance Meter T-10.

$$\rho = \frac{\pi L}{E} \quad (1)$$

No glazing elements were used in the window locations in order to reduce the error of glass under consideration. All junctions are black taped to avoid any light leaks penetrating the model. (Figure 1)



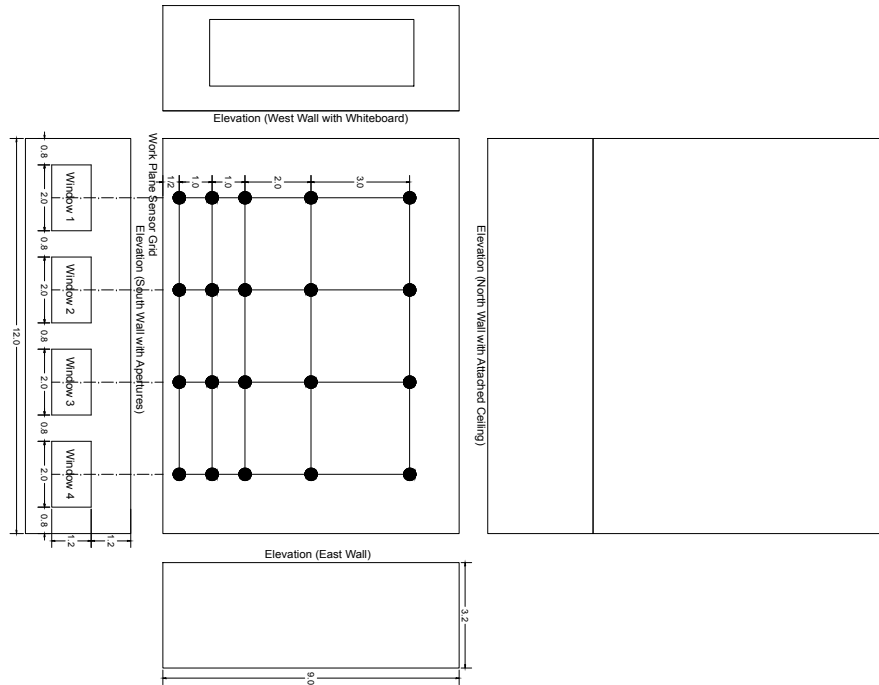
**Figure 1:** Images of the built physical model and on-site location

This experiment was conducted under overcast sky which is the minimum daylight conditions a space can experience. The changes under this sky is less significant compare to other sky conditions and it is the ideal condition for model measurement with less variations and errors for sensor relocations delays (Evans, 1981). The experiment was conducted under overcast sky (Figure 2) in winter Dec 13<sup>th</sup>, at 3:00 PM. The model was placed on a table in an unobstructed open field with consideration of ground element. Consideration of the ground element is particularly important since a high percentage of light entering the model may be reflected from the ground (Reed, 1956). All measured readings were processed to extract DF amount for each sensor point.

**Table 1:** Applied materials in field study

Room Element	Material/Finish	Reflectance (%)
Interior Walls	Museum Board Beige	75%
Floor	Brown Paper	35%
Ceiling	Glossy Foam Board	90%
Whiteboard	Glossy Foam Board	95%

On-site measurements within the physical model were made with a high-quality cosine corrected Minolta T10 illuminance meter with Photocell extensions to measure indoor and outdoor illuminance simultaneously. The photocell sensor was elevated and white taped to a foamboard support to 0.037m offset representing 0.75m above the floor level to measure horizontal interior illuminance levels ( $E_i$ ) in a grid of sensor points (Figure 2). Readings were taken systematically, starting at each window from No.1 grid point and gradually moving to the end at No.5. Simultaneously, outdoor illuminance ( $E_o$ ) was measured at the rooftop of the model to obtain the daylight factor for each sensor point within the grid. For repositioning the sensor, the back wall was reattached to the model and opened for each reading. The photocell wire passed through the precut notch of the side wall and covered by another outer box and black cloth to ensure no light penetrated.



**Figure 2:** Physical model top view with four windows and sensor points location

## 1.2. Simulation with ALFA

*Rhino* 3D modeling was utilized to simulate the classroom and Adaptive Lighting for Alertness (*ALFA*), a new plug-in developed by Solemma, to calculate the circadian lighting levels. *ALFA* extends Radiance engine to conduct spectral back raytracing more than the traditional three red/green/blue channels to 81-color-channel 180° fisheye sensors placed on a vertical plane that can be defined for various view angles. Assigning spectrally accurate properties to the material and skies, allows *ALFA* to create high spectral resolution results. The library includes spectral properties for architectural material and glazing types from the international windows database. Additionally, skies can be generated by radiative transfer library libRadtran for any location on the earth and given time with physically accurate clear, hazy, overcast, and heavy overcast sky conditions.

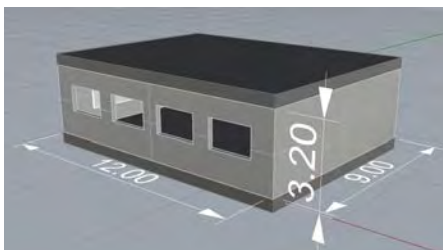
### 1.2.1. Material Reflectance & Spectral Properties

All material selected to match the physical model surface reflectivity to the possible extent, specularity and color (Table 2) from the software material library.

**Table 2:** Simulation material properties from ALFA library

Room Element	Material/Finish	Specularity (%)	Reflectance (%)
Walls	White Paint	0.4%	81.2%
Floor	Interior Flooring	1.1%	38.1%
Ceiling	White Panels	0.5%	84.9%
Whiteboard	Whiteboard	6.7%	87.0%

Sky condition was selected from sky type library to overcast and set to Dec. 13<sup>th</sup> at 3:00PM. All the sensor points defined and recorded for horizontal illumination levels ( $E_i$ ) at the offset of 0.75m. Additional grid set was placed on the roof surface to record the outdoor illuminance ( $E_o$ ) for further process of simulated DF. All recorded readings were processed to extract DF amount for each sensor point.



**Figure 3:** Image of the simulation model

## 2.0. RESULTS & DISCUSSION

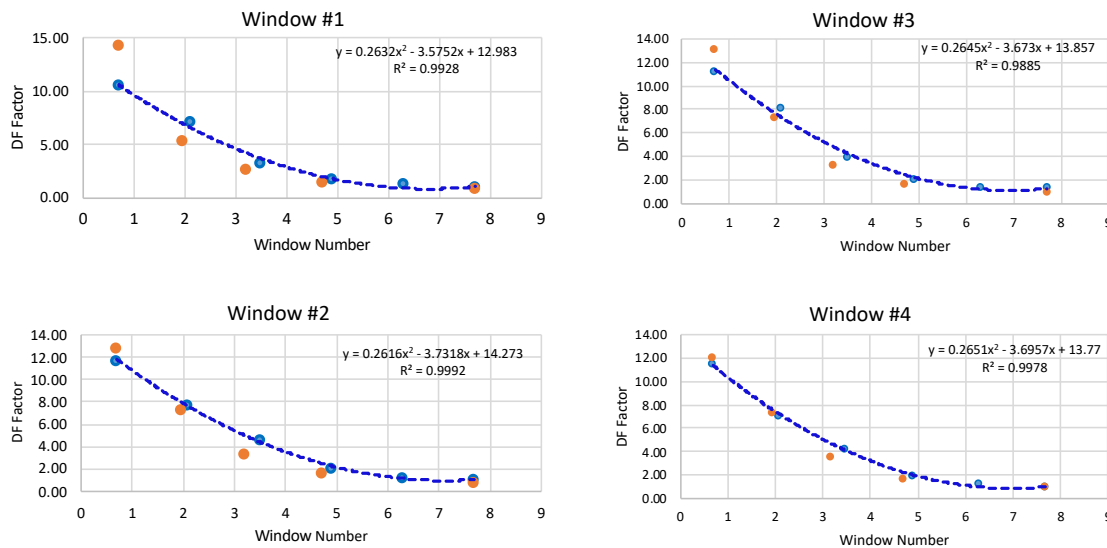
Results from both real measurement and simulation models are processed for comparison and calibration purposes for each window location (Table 3). Data were analyzed after logarithm transformation for a better prediction of the DF curve matching.

**Table 3:** DF Results for Physical Model and Simulation Model

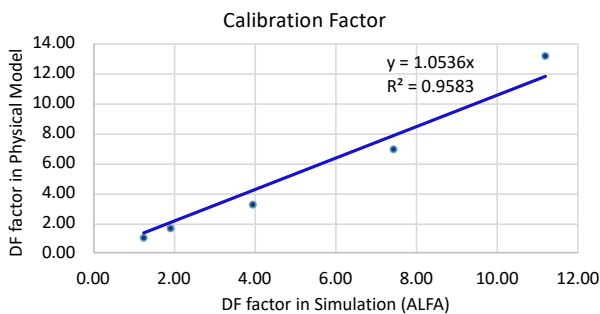
Sensor#	Physical Model DF				Simulation Model DF			
	W#1	W#2	W#3	W#4	W#1	W#2	W#3	W#4
1	14.28	12.75	13.05	11.94	10.50	11.72	11.09	11.43
2	5.26	7.29	7.23	7.27	7.05	7.66	8.09	6.94
3	2.52	3.26	3.23	3.47	3.23	4.56	3.81	4.21
4	1.37	1.65	1.57	1.59	1.74	2.07	2.01	1.88
5	-	-	-	-	1.25	1.15	1.36	1.27
6	0.83	0.83	0.90	0.96	0.91	1.09	1.27	0.91

### 2.1. Calibration

The main intention of this section is to find the calibration factor between simulated daylight factor and calculated daylight factor via field measurement. (Figure 4) shows the daylight factor at each window in both simulation by ALFA and physical model. It can be seen that the value of  $R^2$  is greater than %98 which means the obtained DF factor in physical model and simulation are similar.



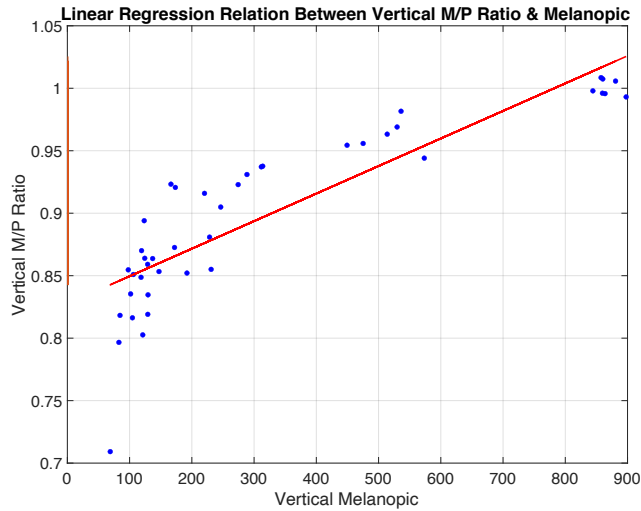
**Figure 4:** Evaluation of daylight factor at each window in both simulation by ALFA and physical model. The calibration also exhibits in (Figure 5) with 0.988963 correlation and 1.0536 calibration factor.



**Figure 5:** Calibration of physical model daylight factor

## 2.2. Linear regression

The main focuses of this part are to predict the M/P ratio at vertical level based on the physical measurement at horizontal measurements. In order to achieve this goal, we utilized the capability of linear regression technique to predict the M/P ratio. To run the linear regression two set of the data has been generated by ALFA software in two levels  $ptZ = 0.76 (m)$  and  $ptZ = 1 (m)$ . The output of the ALFA software in the front view direction is used for the training process of linear regression process. The result of linear regression is shown in (Figure 6) with value of the  $R^2 = \%75.12$  and two coefficients 0.8275, and 0.0002.



**Figure 6:** Linear regression relation between vertical M/P ratio and melanopic

According to the multiple linear regression model the relationship between M/P ratio for each sensor can be explain a linear combination of daylight factor in physical model at horizontal level.

$$\left(\frac{M}{P}\right)_i^{vertical} = 0.8275 + 0.001469 \cdot DF_{i,physical}^{horizontal} \quad (2)$$

To validate the result of our regressed model, we compared the calculated M/P ratio by simulation and physical model in (Table 4). It can be seen that, the results are very close with maximum absolute relative error  $\%7.57844$  and minimum absolute relative error  $\%0.018825$ , and average absolute relative error  $\%2.6597$ .

**Table 4:** Comparison between M/P ratio in ALFA and physical model

Regressed M/P	M/P simulation
1.037218868	0.9930816
0.904764846	0.9049352
0.864569679	0.852101
0.847629234	0.8190656
0.839687021	0.8547105
1.01475693	1.007446
0.934574275	0.95583
0.87533727	0.8550628
0.851737608	0.8940082
0.839717331	0.818233
1.019139045	1.005745
0.933768976	0.9632565
0.875002691	0.9228988
0.850617304	0.8725748
0.840734554	0.8346803
1.002882531	1.008526
0.934320163	0.9440605
0.878503713	0.9371352
0.85086566	0.9206355
0.841605653	0.8509431

## CONCLUSION

We investigated the result of ALFA software with field measurement in a typical physical model of a hypothetical classroom. The results show that simulation model can be calibrated by using a factor of 1.0536 and also the proposed linear regressed model gave most reasonable results with average absolute relative error %2.6597. From this point-in-time measurement we can conclude that physical models can represent real conditions for circadian lighting while in early design stage to enhance the design strategies of window openings, shading and fenestration.

This study is focused on a point-in-time measurement to calibrate the horizontal light levels by recording the photopic lux levels at the work plane for DF comparison that can be developed for annual daylight analysis. More considerations and parameters can be taken in account in future studies to improve the effectiveness of the space to experience higher levels of circadian content from daylight. Furthermore, extensive melanopic/photopic ratio validation can be explored through pixel comparison and luminance maps of an HDR image from a particular view angle to be compared for both real life and simulation model to confirm the suggested factors.

## REFERENCES

- Amundadottir, M. L., Rockcastle, S., Sarey Khanie, M., & Andersen, M. (2017). A human-centric approach to assess daylight in buildings for non-visual health potential, visual interest and gaze behavior. *Building and Environment*, 113, 5–21. <https://doi.org/10.1016/j.buildenv.2016.09.033>
- Baker N, S. K. (2014). *Daylight design of buildings: a handbook for architects and engineers*. Routledge.
- Berman, S. M. (2008). A new retinal photoreceptor should affect lighting practice. *Lighting Research and Technology*, 40: 373.
- Berman, S. M., & Clear, R. D. (2019). A practical metric for melanopic metrology. *Lighting Research and Technology*, 51(8), 1178–1191. <https://doi.org/10.1177/1477153518824147>

- Boubekri, M., Cheung, I. N., Reid, K. J., Wang, C. H., & Zee, P. C. (2014). Impact of windows and daylight exposure on overall health and sleep quality of office workers: A case-control pilot study. *Journal of Clinical Sleep Medicine*, 10(6), 603–611. <https://doi.org/10.5664/jcsm.3780>
- Brainard, G. C., Hanifin, J. R., Greenson, J. M., Byrne, B., Glickman, G., Gerner, E., & Rollag, M. D. (2001). Action spectrum for melatonin regulation in humans: Evidence for a novel circadian photoreceptor. *Journal of Neuroscience*, 21(16), 6405–6412. <https://doi.org/10.1523/jneurosci.21-16-06405.2001>
- Evans, B. H. (1981). *Daylighting in Architecture*. McGraw-Hill Inc.
- Konis, K. (2017). A novel circadian daylight metric for building design and evaluation. *Building and Environment*, 113, 22–38. <https://doi.org/10.1016/j.buildenv.2016.11.025>
- Konis, K. (2019). A circadian design assist tool to evaluate daylight access in buildings for human biological lighting needs. *Solar Energy*, 191(August), 449–458. <https://doi.org/10.1016/j.solener.2019.09.020>
- Lockley, S. W., Arendt, J., & Skene, D. J. (2016). Visual impairment and circadian rhythm sleep disorders. *The Curated Reference Collection in Neuroscience and Biobehavioral Psychology*, 428–437. <https://doi.org/10.1016/B978-0-12-809324-5.01285-2>
- Love J.A., Navab M. (1991). Daylighting Estimation Under Real Skies: A Comparison of Full-scale Photometry, Model Photometry, and Computer Simulation. *LEUKOS The Journal of the Illumination Engineering Society of North America*.
- Lucas, R. J., Peirson, S. N., Berson, D. M., Brown, T. M., Cooper, H. M., Czeisler, C. A., ... Brainard, G. C. (2014). Measuring and using light in the melanopsin age. *Trends in Neurosciences*, 37(1), 1–9. <https://doi.org/10.1016/j.tins.2013.10.004>
- Norsk IPR : Norwegian Green Building Council Internasjonal IPR : BRE Global. (2012).
- Rea, M. S., Figueiro, M. G., Bierman, A., & Bullough, J. D. (2010). Circadian Light Defined. *Journal of Circadian Rhythms*, 8(2), 12180–12180.
- Reed, B. H. (1956). Effects of Nearby Walks and Concrete Areas on Indoor Natural Lighting. *Illuminating Engineering*.
- Solemna- ALFA. (2019). Retrieved from <https://www.solemna.com/Alfa.html>
- Tanner, C. K. (2009). Minimum classroom size and number of students per classroom: Overview of the problem. *Revised Findings and Conclusions*, (1985), 1–2. Retrieved from [https://www.scarsdaleschools.k12.ny.us/cms/lib/NY01001205/Centricity/Domain/1105/2014-11-19 Meeting of Greenacres Building Committee Meeting Handout 3 - Classroom Size Standards.pdf](https://www.scarsdaleschools.k12.ny.us/cms/lib/NY01001205/Centricity/Domain/1105/2014-11-19%20Meeting%20of%20Greenacres%20Building%20Committee%20Meeting%20Handout%203%20-%20Classroom%20Size%20Standards.pdf)
- Thapan, K., Arendt, J., & Skene, D. J. (2001). An action spectrum for melatonin suppression: Evidence for a novel non-rod, non-cone photoreceptor system in humans. *Journal of Physiology*, 535(1), 261–267. <https://doi.org/10.1111/j.1469-7793.2001.t01-1-00261.x>



# A Pilot Study on the Contextual and Environmental Factors Influencing Window Shading Preference

Anupam Satumane<sup>1</sup>, Siobhan Rockcastle<sup>1</sup>

<sup>1</sup> Baker Lighting Lab, University of Oregon, Eugene, OR

**ABSTRACT:** The use of window shading devices can affect building energy use, supplemental lighting demands and occupant well-being related to performance, alertness, and satisfaction. Past studies that have explored the impact of window shading devices on building and occupant performance have been done primarily in the context of office buildings. With the aim of expanding this research to healthcare, hospitality, and educational spaces; this study investigates the influence of program type and sky condition on window shading preferences for a number of shading types. This paper introduces an online survey that recorded participant preferences for eight window shading conditions in the context of six spaces with varying program types. The selected program types represent spaces commonly found in education, hospitality, and healthcare with two levels of privacy; 'high privacy', with a typical maximum occupancy of two people and 'low privacy,' with furniture designed to accommodate a group of people. A questionnaire was circulated on social media platforms to recruit anonymous participants, who were given a brief description of the program types and then exposed to eight images of that space with varying window treatment conditions. Participants were asked to assign a preference rank to each of the eight window shading conditions for each of the six program types included in our study. This was done to determine whether building occupants prefer 'closed' window shading conditions in 'high privacy' and 'open' shading conditions in 'low privacy' spaces. As hypothesized, 'half closed' window shading settings were preferred for program types with 'low privacy' requirement and 'full closed' window shading conditions were preferred for spaces with 'high privacy' requirement. The results from this study showed that contextual factors such as program type and environmental factors such as sky condition impact a participant's preference for window shading types and the degree of preferred occlusion.

**KEYWORDS:** Windows, human behavior, blind-use, window shades, privacy

## INTRODUCTION

Windows play a vital role in the built environment, providing building users with daylight, ventilation, access to views and a visual connection with the outdoor environment. Daylight promotes the visual, emotional, and psychological well-being of building users (Boubekri, Hull, and Boyer 1991) and is a preferred method of indoor illumination by building users and architects (Robbins 1986). In addition to daylight and ventilation, windows promote the psychological health of the occupants by alleviating claustrophobia, monotony, and boredom; they also promote the building's aesthetic and property value (Collins 1975). 'Window blinds' or 'window shades' are common terms for a wide range of devices used to partially or fully cover window openings. They may be part of the building's interiors, located outside the building or integrated within the building envelope. Window shading systems provide building occupants with a certain degree of control over their immediate surroundings. Studies have shown that occupants prefer to have control over physical conditions such as lighting and temperature in the indoor environment (Bell et al. 1996).

Occupant-window blind interaction, henceforth referred to as 'blind use' in this paper, is motivated by numerous factors. Stazi, Naspi, and D'Orazio, 2017 categorized these factors into environmental, contextual and personal factors. Rea, 1984 expanded the environmental and contextual factors to include window orientation, weather conditions, lighting conditions, time of day, geographic location, occupant position relative to the window and occupant habits. A large number of precedent studies have investigated blind-use in relation to environmental factors such as daylight penetration (Newsham 1994) (Boubekri, Hull, and Boyer 1991) (Rea 1984), thermal conditions (Raja et al. 2001) (Haldi and Robinson 2009) (Lindsay and Littlefair 1992), lighting conditions (Sutter, Dumortier, and Fontoynt 2006) (Reinhart and Voss 2003) (Mahdavi and Pröglhöf 2008); and contextual conditions such as window orientation (Inoue et al. 1988) (Eilers, Reed, and Works 1996), occupant distance from the window (Thomas 1967), and occupant behavior (Inoue et al. 1988) (Haldi and Robinson 2009). That being said, research studies investigating the relationship between social factors such as privacy, cultural background, preference *and* contextual factors such as space function and their impact on blind use are relatively scarce. Numerous studies have tried to explain blind use behavior by examining the correlation between singular motivation factors such as lighting conditions or thermal conditions, but they lack the ability to explain or predict blind use in a broad range of space typologies. The wide variation between recorded and correlated factors in precedent studies indicate the presence of blind use triggers that are still missing and need to be identified and studied to accurately predict and understand blind use.

A majority of the precedent studies investigating blind use have been done in the context of office and residential buildings, but there is limited research in the context of broader programmatic uses. Office buildings are typically occupied by adults engaged in professional activities in a formal setting and are occupied during business hours. The blind use patterns and behavior models derived from studying office environments cannot be generalized and applied to healthcare, hospitality and educational settings as they have users with very different behavior, preferences, and privacy requirements. It is therefore critical to investigate blind use in relation to building space function, user demographics, and privacy preference. These factors have the potential to impact blind-use behavior models and preferences toward window shading type that should influence design guidelines for architects.

Windows provide occupants with a visual connection to the outdoor environment; however, this visual connection is often compromised when occupants close window shading devices to increase indoor privacy or to facilitate activities related to the building space function. The study presented in this paper investigated the influence of factors such as program type, privacy setting, and window shading type on window shading preference. With an aim to expand blind use studies to healthcare, hospitality and educational building space functions, six pervasive building spaces were selected to be tested: two for each of the three space function categories. They were selected to be representative of spaces in the education, hospitality, and healthcare sectors and represent two levels of privacy. The first being 'high privacy' spaces with a maximum occupancy of two people at any given time, such as the hotel room, school counsellor's office, and dental clinic. The second being 'low privacy' spaces with a typical occupancy exceeding two people at any given time. This was done to test the hypothesis; 'building occupants prefer 'closed' window shading conditions in the 'high privacy' and 'open' in the 'low privacy' spaces. The authors acknowledge that the factors and program types investigated in this pilot study are limited and additional factors and program types need to be investigated in future studies. The program types investigated in this study were selected to be representative of pervasive spaces in the healthcare, hospitality and educational sectors.

## 2.0 RESEARCH METHODOLOGY

### 2.1. Overview of Methods

This study investigated the influence of factors such as program type, privacy setting, and sky condition on shading condition preferences using an online survey. An indoor space, modelled in Rhino (<https://www.rhino3d.com/>), was used to create ninety-six images which are a combination of the six program types, eight window shading conditions and two sky conditions. Each image was rendered using Twinmotion (<https://www.unrealengine.com/en-US/twinmotion>) with recessed electric lighting fixtures that are turned on independent of external daylight conditions. A questionnaire was designed to record the participant's preference to window shading types and shading conditions in the context of six spaces with varying program types. The questionnaire was circulated on social media platforms (Instagram, Facebook, and LinkedIn) to recruit anonymous participants for the study. No personally identifiable information was recorded, and no incentives were provided to the subjects for participating in the study. The participants were first given a brief description of a space with a well-defined program type and were exposed to eight images of that space with varying window shading conditions. They were then asked to assign a preference rank to each of the eight window shading conditions. This process was repeated for the six program type cases. The ranking system followed a descending order of ranking, with rank 1 for the most preferred window shading condition and rank 8 for the least preferred window shading conditions for example: the image that is preferred less than rank 1 is ranked 2 (rank 1 > rank 2 > rank 3 > rank 4 > rank 5 > rank 6 > rank 7 > rank 8). The ranking data from the participants are represented as 'Preference Ranking Score' and is abbreviated to PRS for the ease of readability in this paper.

### 2.2. Test conditions and variables

The study used a digitally modeled south facing building shell located on the first floor, with a view of a typical urban setting through the South facing window. The South facing window was selected for this study as the sun penetration and influence of time of the day from a South facing window were assumed to be minimal. The building shell was used to simulate six program types as seen in figure 1 and eight window shading condition as seen in figure 2. Furniture was selected to indicate program type in parallel with the space description provided at the beginning of each question set. The six program types selected for this study were: classroom, counsellor office, hotel room, hotel gym, waiting room in clinic and dentist clinic as seen in figure 1. They were selected to be representative of spaces in the education, hospitality, and healthcare sectors and also represent the two levels of privacy under each of the three sectors. The first being 'high privacy' spaces with a maximum occupancy of two people at any given time, such as the hotel room, school counsellor office, and dental clinic. The second being 'low privacy spaces' with a typical occupancy exceeding two people at any given time.



**Figure 1:** Program type variables

The textual description of each of the program types spaces accompanying the images in the questionnaire are listed below

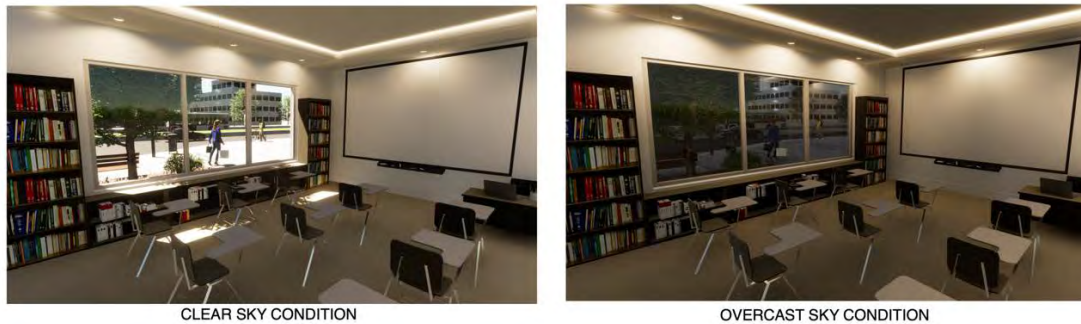
1. *Classroom:* A classroom for school children. Typically used by students, teachers and supporting staff.
2. *Waiting room in clinic:* This space is the room in a private clinic where patients wait to be examined by the Doctor. Typically used by patients and service staff.
3. *Hotel gym:* A Gymnasium attached to a hotel, mainly used by guests for working out. Typically used by hotel guests and service staff.
4. *Counsellor office:* An office and discussion space where the school counselor assists students with their academic and personal issues or concerns. Typically used by the counselor and a student
5. *Dentist clinic:* The room in a dentist's clinic where all dental procedures are performed on the patients. Typically used by the dentist and a patient.
6. *Hotel room:* A typical hotel room with an attached bath that you would occupy for a short duration of time. Typically used by the hotel guest

The eight window shading conditions were created to reflect widely used window shading devices such as curtains, roller blinds and venetian blinds. Two shading conditions were created for each of the three window shading devices; the first being 'half closed' setting where the shading device covers half of the window area providing 50% blind occlusion. The second setting being 'full closed', where the shading device covers the whole of the window area providing 100% blind occlusion. For ease of readability, the 'half closed' setting will be abbreviated to HC and the 'full closed' setting will be abbreviated to FC in this paper. The eight window shading conditions are illustrated in figure 2, six of the eight unique shading conditions were created using curtains, roller blinds, and venetian blinds in semi-open (50% occlusion) and closed settings (100% occlusion). The remaining two being the base case with no shading device and skylight



**Figure 2:** Window shading variables

Two versions of the questionnaire were created; one for each of the two sky conditions, allowing for the effect of weather on window shading preference to be observed. The first condition is a 'clear sky' condition, where the outdoor environment is brightly lit by daylight and the objects and people in the background are clearly visible. The second condition is an 'overcast sky' condition which simulates outdoor lighting during a heavily overcast sky, where objects and people in the background are not clearly visible. For ease of readability, the 'clear sky' condition and 'overcast sky condition' will be abbreviated to CS and OS respectively. The two sky conditions are illustrated in figure 3 for the classroom space.



**Figure 3:** Sky condition variables

The online survey tool randomly assigned participants to one of two versions of the survey, either the clear sky condition version or the overcast sky condition version. Participants were unaware that there were two versions of the survey and the sky condition was not explicitly mentioned. The participants were then asked to rank the 8 window shading conditions through the context of each program type. The total number of completed responses received were  $n=15$  for clear sky conditions(CS) and  $n=15$  for overcast sky conditions(OS). While this is a limited sample population, it serves as a pilot to determine potential effects and lay the groundwork for an extended future experiment.

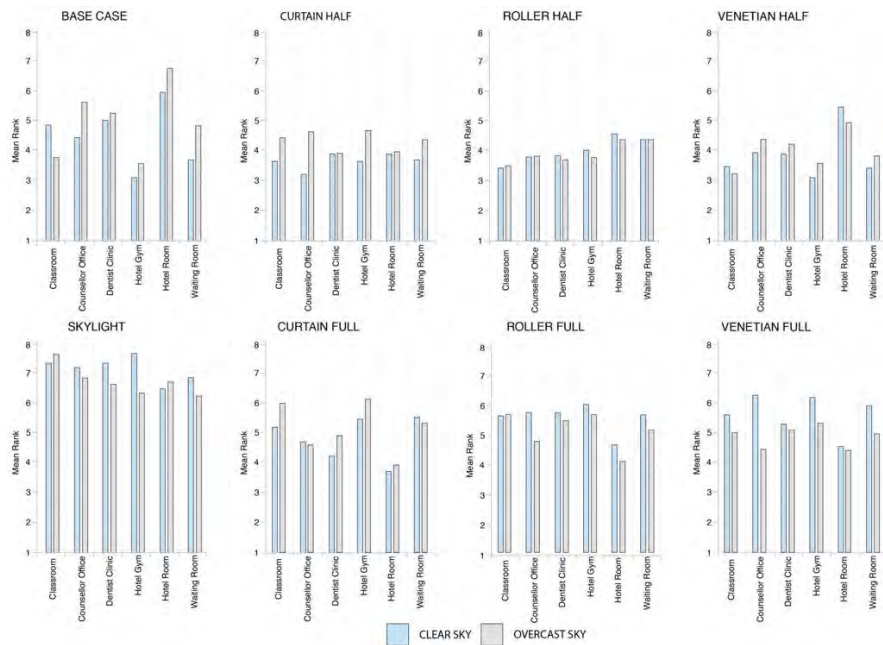
### 3.0 DATA ANALYSIS

#### 3.1. Influence of sky condition and program type on mean preference ranking score

In the first stage of data analysis, the window shading conditions were grouped based on window shading type and average preference ranking score(PRS). The data was split into two categories based on the sky condition to represent both CS and OS conditions with their average PRS, shown in Figure 4. The parallel bar graphs display the average PRS according to sky condition in addition to program type. A broad look at the data suggests that specific window shading types and conditions are preferred in specific space use cases. Curtains, roller blinds, and venetian blinds in the half closed(HC) setting are preferred in classrooms, counsellor office and dentist clinic; suggesting that these spaces require a combination of view to the outdoors and maintained privacy. Curtains in HC and full closed(FC) settings are equally preferred in hotel rooms, indicating that the 'curtain' is most preferred shading type in hotel rooms. Venetian blinds in the HC setting and base case (no shading device) are preferred in the hotel gym suggesting the strong emphasis on the need for a view in this space. For waiting rooms HC venetian blinds, curtains and base case were preferred emphasizing the need for a view in this space. Roller blinds in the HC setting is the most preferred window shading condition across all program types and sky conditions with very less variation between the program types. The mean PRS for this shading condition ranges from a high of 3.5 in the classroom to a low of 4.3 in the waiting room, with a variation between the sky conditions of less than 0.4. Window shading devices in the HC setting (curtain half, roller half and venetian half) were more preferred than the FC setting (curtain full, roller full and venetian full), which indicates that a combination of privacy and view was desired.

As hypothesized, HC shading conditions ranked higher than FC shading conditions for program types with low privacy requirement (classroom, hotel gym and waiting room). The FC shading conditions ranked higher than HC shading conditions for programs with high privacy requirement (counsellor office, hotel room, dentist clinic). This indicates that the degree of blind occlusion is directly related to the privacy requirement of for each program type. The greatest difference between the preferred degree of occlusion can be observed between the hotel gym and hotel room types across each of the three shading types. The highest variability among mean PRS values between the CS and OS sky conditions along the six program types is seen in the base case: with the highest mean PRS of 3 for CS, 3.5 for OS and lowest mean PRS of 6 for CS, 6.7 for OS.





**Figure 4:** Mean preference ranking score of window shading conditions

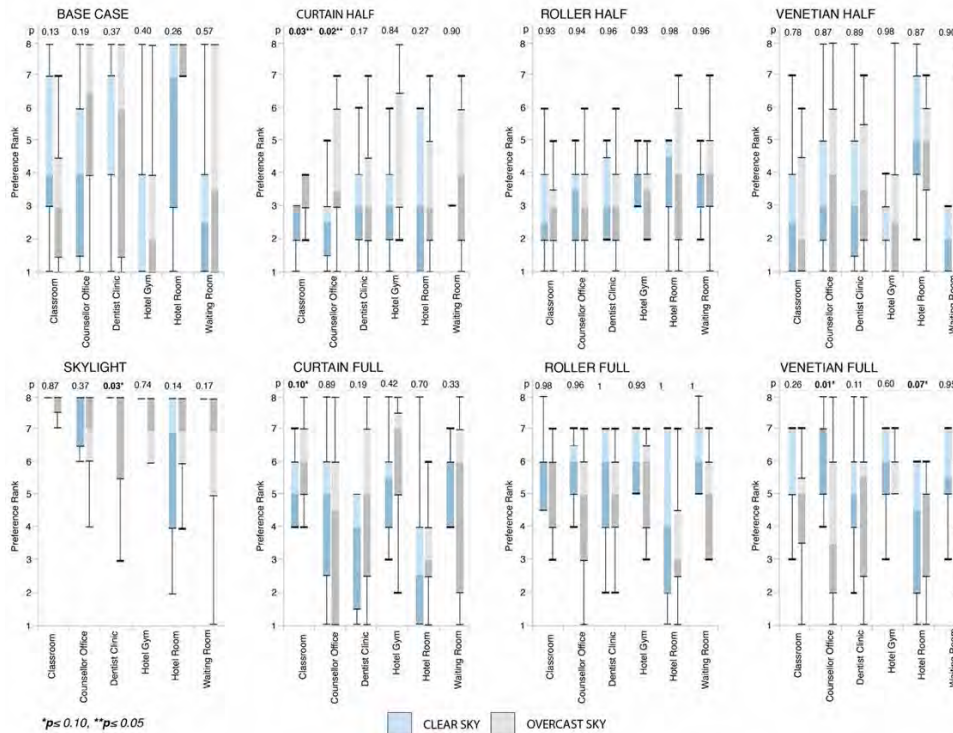
As the base case offers unobstructed views to the outdoor environment, the impact of the weather conditions on the preference ranking decision of the participants are exaggerated, explaining the high variability in the mean PRS between the sky conditions. The skylight is the least preferred window shading condition across all program types and sky conditions. With very less variation between program types. The mean PRS scored by skylight ranges from 6.8 for CS and 6.3 for OS observed in the waiting room to 7.4 for CS and 7.6 for OS in the classroom

### 3.2. Influence of sky condition and program type on distribution of preference ranking score

In the second stage of data analysis, the window shading conditions were grouped based on window shading condition. The distribution of PRS values were then compared for each space typology. A non-parametric two tailed test was used to compare the differences in PRS distribution between the CS and OS sky conditions. As the two groups were independent and the data was not normally distributed the Mann-Whitney U test was selected. The PRS of CS (n=15) was tested against the PRS of the OS (n=15) for each of the six program types and eight window shading conditions. The data distribution for the two groups and the results from the Mann-Whitney U test are shown in Figure 5. The findings demonstrate that the scores are widely distributed in some cases indicating greater variability among the sample scores and are narrowly distributed for other conditions indicating greater consistency.

For the base case shading condition, the PRS is widely distributed for all program types with the upper quartiles extending to the PRS 8 and the lower quarter extending to the PRS 1. The medians for CS and OS within each program type also greatly differ. This indicates that the preference for the base case according to program type and sky conditions greatly vary between the participants. Although the distributions greatly differ, the p-values from the Mann-Whitney U test do not indicate a significant difference ( $p \leq 0.05$  or  $p \leq 0.1$ ) between the two sky conditions for any of the program types under the base case window condition.

The PRS distribution patterns observed in the curtain HC, venetian blind HC and curtain FC shading conditions are very similar. They show greater variability in the distribution of PRS in the OS condition than CS conditions across all program types, except for the hotel room. The PRS distribution of the CS conditions is observed to be relatively narrower and are located towards the higher end of the data distribution, indicating higher preference. The greater variability in PRS is seen in the OS conditions is due to the shift of the scores toward their lower PRS which indicates that the preference for the curtain HC, venetian blind HC and curtain FC shading conditions is lower during overcast sky conditions than clear sky conditions.



**Figure 5:** Preference ranking distribution and Mann-Whitney U test results

However, the opposite trend is seen only in the hotel room program type where greater variability is seen in the CS conditions with a shift towards lower PRS. The Mann-Whitney U tests results for the curtain HC shading condition showed statistically significant difference between OS and CS conditions for classroom and counsellor office program type with a p value of 0.03 and 0.02 respectively, demonstrating the significant impact of sky conditions on preference ranking scores in the context of classroom and counsellor office program type.

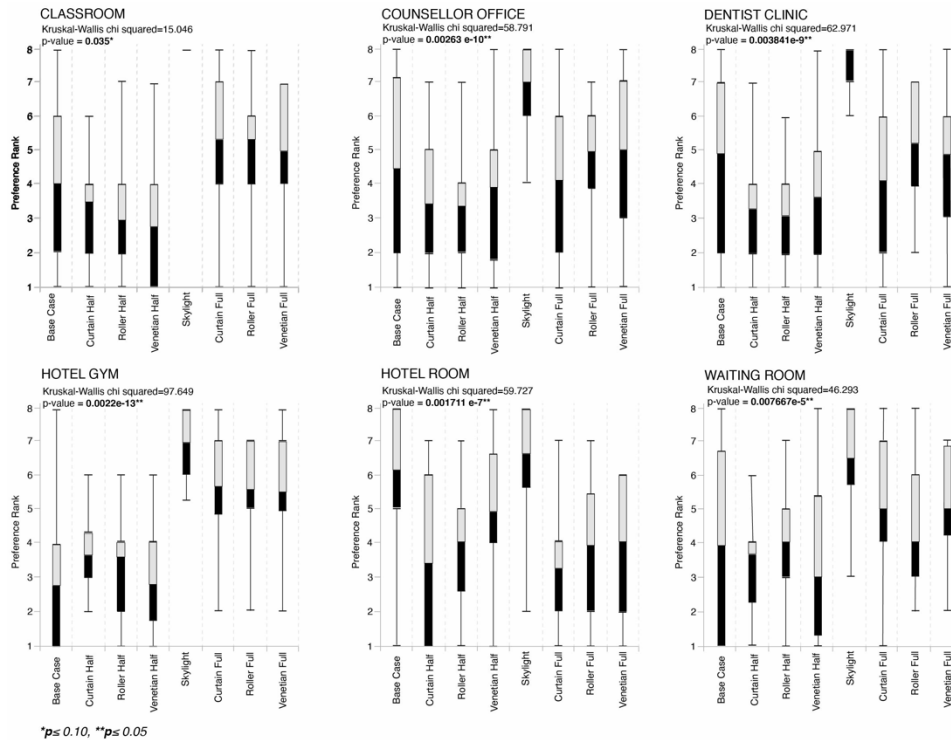
In the case of the venetian blinds and roller blinds in the FC condition, the PRS are similar and widely distributed for OS condition in comparison to CS condition. However, the distribution is shifted towards higher PRS, indicating that FC venetian blinds and roller blinds are more preferred during overcast sky conditions. The Mann-Whitney U test found a significant statistical difference between OS and CS conditions for the counsellor office in the FC setting for venetian blinds and roller blinds with p-values of 0.01 and 0.07 respectively. The distribution of PRS were observed to be the most consistent in the roller blind HC condition across all program types and sky conditions, there is very little variation in the medians between the CS and OS conditions which shows that sky conditions have the least impact on preference ranking scores for this shading condition.

The skylight condition consistently scored the lowest PRS scores across all the window shading condition. Among the two sky conditions, skylight was the least preferred in the CS condition is due to the distinctive and bright sunlight pattern formed on the floor in the test images, that are a result of direct sunlight penetration. The pronounced sunlight seen during clear sky conditions may be contributing to the difference in preference rankings between the sky conditions. The PRS distribution in the OS condition show some variation, with their medians located at a low score of seven. The Mann-Whitney U test found a significant statistical difference between OS and CS conditions for the dentist clinic with a p value of 0.03.

### 3.3. Influence of sky condition and window shading conditions on distribution of preference ranking score

In third stage of the data analysis, the window shading conditions tested were grouped based on program type and the distribution of PRS was examined for each shading condition. A non-parametric test was used to compare the differences in PRS distribution between the eight window shading conditions for each of the six program types. As the eight groups were independent and the data was not normally distributed the Kruskal-Wallis one way analysis of variance test was selected. The PRS of the eight window shading conditions were tested, where n=30 (15 OS + 15 CS) for each shading case. The data distribution for the eight groups and the results from the Kruskal-Wallis test is shown in Figure 6.

Figure 6 demonstrates the wide variation seen in the PRS distribution based on program type and window shading conditions. However, a deeper analysis of the data revealed patterns in preference of certain shading devices and shading conditions for specific program type. For the classroom program, HC shading conditions were highly preferred in relation to the same shading devices in the FC setting, with a difference of about 2 preference ranks. The PRS distribution of OS conditions for all window shading conditions were lower than CS conditions, except in the base case. In the hotel gym program type, the PRS distribution pattern was observed to be similar to the distribution pattern of scores in the classroom where the ‘half closed’ shading conditions were highly preferred to the ‘full closed’ setting. However, unlike the pattern observed in the classroom program type; the PRS distribution of OS conditions for all window shading conditions were higher than CS conditions.



**Figure 6:** Preference ranking distribution and Kruskal-Wallis test results

The PRS distribution seen in the hotel room program type indicates that FC window shading conditions were highly preferred over their HC window shading conditions. Therefore, it can be inferred that higher degree of blind occlusion is desired in the hotel room when compared to the other five program types and this change in preference can be attributed to the high level of privacy required in the space.

The results of the Kruskal-Wallis test found statistically significant differences in the preference ranking scores between the eight shading conditions and six program types. The p-values for these analyses were found to be 0.035 for the classroom, 0.00263 e-10 for the counsellor office, 0.003841 e-9 for dentist clinic, 0.0022 e-13 for the hotel gym, 0.001711 e-7 for the hotel room and 0.007667 e-5 for the waiting room. Taking into account the results from the Kruskal-Wallis one way analysis of variance test, we can infer that there is a statistically significant difference in PRS between window shading conditions for the six program types in our study. It also provides evidence that preference for window shading type and degree of blind occlusion are influenced by the program type.

## CONCLUSION

The results from this study revealed that contextual factors such as program type, degree of privacy, and environmental factors such as sky condition impact a participant’s preference for window shading types and their degree of occlusion. Analysis of mean preference ranking scores revealed that curtains, roller blinds and venetian blinds in the half-closed setting are desired in program types such as classroom, counsellor office and dentist clinic; which indicates the preference to have view to the outdoors *and* privacy in these spaces. The strong preference for venetian blinds in the half closed setting and base case for the hotel gym program type suggests that privacy is not the main concern of the participants in this space and view to the outdoors is valued. When you consider all program types and sky conditions together, the roller blind in the half-closed setting was the most highly ranked. From this, we could infer that the half-closed roller blind obstructs view at eye level from the outdoors while still allowing daylight to enter. As such, it may



address privacy concerns while only partially obstructing the view to the outdoors. As hypothesized, half closed window shading types were preferred over fully closed window shading types for program types with 'low privacy' requirement (classroom, hotel gym and waiting room). Additionally, fully closed window shading conditions were preferred over half closed window shading conditions for program types with 'high privacy' requirement (counsellor office, hotel room and dentist clinic). This finding indicates that the degree of blind occlusion is directly related to the privacy requirement of a building space defined by its program type.

A careful examination of the distribution of preference ranking scores for clear sky and overcast sky conditions showed that there is greater variability in the distribution of the scores in the overcast sky conditions with a shift towards lower preference ranking scores. The consistently low preference ranking for the skylight condition under the clear sky condition shows the influence of pronounced sunlight pattern resulting from direct sunlight entering the space. In this context, direct sun through the skylight was less preferred than the side-lit windows. The results of the Kruskal-Wallis test found statistically significant difference in the preference ranking scores between the eight shading conditions and six program types. It also provides evidence that preference for window shading type and degree of blind occlusion are influenced by the program type.

The findings from this study provide strong evidence to suggest that window shading preference is directly influenced by contextual factors such as program type and sky condition. It also highlights the incompatibility of generalizing window blind use recommendations from studies on office program types to other program types with varying degrees of anticipated privacy. Blind use studies need to be expanded to broader programmatic use types in order to develop more robust and accurate models for predicting preference/behavior and creating better guidelines for the design of shading devices. The authors acknowledge that the factors and program types investigated in this pilot study are limited and additional factors and program types need to be investigated in future studies.

## REFERENCES

- Bell, Paul A., Thomas C. Greene, Jeffrey D. Fisher, and Andrew Baum. 1996. *Environmental Psychology*. Harcourt.
- Boubekri, Mohamed, Robert B Hull, and Lester L Boyer. 1991. "Impact of Window Size and Sunlight Penetration on Office Workers' Mood and Satisfaction: A Novel Way of Assessing Sunlight." *Environment and Behavior* 23 (4): 474–93.
- Boubekri, Mohamed, Robert B. Hull, and Lester L. Boyer. 1991. "Impact of Window Size and Sunlight Penetration on Office Workers' Mood and Satisfaction: A Novel Way of Assessing Sunlight." *Environment and Behavior* 23 (4): 474–93.
- Collins, Belinda Lowenhaupt. 1975. *Windows and People: A Literature Survey: Psychological Reaction to Environments with and without Windows*. Vol. 70. US Department of Commerce, National Bureau of Standards.
- Eilers, Mark, John Reed, and TecMRKT Works. 1996. "Behavioral Aspects of Lighting and Occupancy Sensors in Private Offices: A Case Study of a University Office Building." In *Summer Study on Energy Efficiency in Buildings*.
- Haldi, Frédéric, and Darren Robinson. 2009. "Interactions with Window Openings by Office Occupants." *Building and Environment* 44 (12): 2378–95.
- Inoue, T., T. Kawase, T. Ibamoto, S. Takakusa, and Y. Matsuo. 1988. "The Development of an Optimal Control System for Window Shading Devices Based on Investigations in Office Buildings." *ASHRAE Transactions* 94: 1034–49.
- Inoue, T., T. Kawase, T. Ibamoto, S. Takakusa, and Y. Matsuo. 1988. "The Development of an Optimal Control System for Window Shading Devices Based on Investigations in Office Buildings." *ASHRAE Transactions* 94: 1034–49.
- Lindsay, C., and P. J. Littlefair. 1992. "Occupant Use of Venetian Blinds in Offices." *Building Research Establishment*.
- Mahdavi, Ardeshir, and Claus Pröglhöf. 2008. "169: Observation-Based Models of User Control Actions in Buildings." In *Proc. PLEA*. Citeseer.
- Markus, Thomas A. "The function of windows—A reappraisal." *Building Science* 2, no. 2 (1967): 97-121.
- Newsham, G. R. 1994. "Manual Control of Window Blinds and Electric Lighting: Implications for Comfort and Energy Consumption." *Indoor Environment* 3 (3): 135–44.
- Raja, Ifkhar A., J. Fergus Nicol, Kathryn J. McCartney, and Michael A. Humphreys. 2001. "Thermal Comfort: Use of Controls in Naturally Ventilated Buildings." *Energy and Buildings* 33 (3): 235–44.
- Rea, Mark S. 1984. "Window Blind Occlusion: A Pilot Study." *Building and Environment* 19 (2): 133–37.
- Robbins, C. L. 1986. "Daylighting: Design and Analysis, 1986." *New York*.
- Stazi, Francesca, Federica Naspì, and Marco D'Orazio. 2017. "A Literature Review on Driving Factors and Contextual Events Influencing Occupants' Behaviours in Buildings." *Building and Environment* 118: 40–66.
- Sutter, Yannick, Dominique Dumortier, and Marc Fontoynt. 2006. "The Use of Shading Systems in VDU Task Offices: A Pilot Study." *Energy and Buildings* 38 (7): 780–89.

# Non-Rigid Formwork System for Sustainable Concrete Construction

Giovanni Loreto<sup>1</sup>, Arash Soleimani<sup>1</sup>, Lauren Stewart<sup>2</sup>

<sup>1</sup>Kennesaw State University, Marietta, GA  
<sup>2</sup>Georgia Institute of Technology, Atlanta, GA

**ABSTRACT:** The last hundred years in civil engineering have been widely dominated by the use of concrete and cementitious materials. Concrete use has become so prevalent that it is now the second most consumed commodity after water. In 2019, world production of cement amounted to approximately 2.8 billion tons, with production and use accounting for almost 8-9% of total global anthropogenic greenhouse gas emissions. The technology has improved, providing stronger and more durable concrete; however, the construction techniques have not advanced at the same rate. Despite continuous and constant innovations, the traditional use of rigid, flat formwork panels has defined reinforced concrete members as a uniform cross-section, prismatic structural elements in both design codes and construction methods. These resultant shapes have become practically an inevitable conclusion for concrete constructions.

This research presents experimental results on the use of a non-rigid formwork system that has been developed by looking at different parameters, including mold materials, mold configurations, and construction methods. The analysis of a potential flexible formwork is tested, and results are compared to that of rigid formwork. In addition, an optimized high-performance concrete mixture developed to take full advantage of the new formwork system and address problems related to reinforcement and construction methods is also presented.

The results show that using such technology enhances material reduction and design optimization compared to traditional concrete mold systems while improving sustainability, performances, and adaptation to various architectural forms. By challenging the paradigm of rigid formwork, this paper introduces a technology that impacts the embodied energy and the carbon emission associated with new concrete constructions by possibly saving up to 30% in concrete volume compared to an equivalent strength prismatic member. In addition, the provision of an inexpensive, extremely lightweight, and globally available formwork material in place of wood will help address the need for housing in building economies that rely on reinforced concrete construction but lack in access to wood construction materials. Thus this research presents results that offer exciting opportunities for engineers and architects to move towards a more sustainable construction industry.

**KEYWORDS:** Concrete, Non-Rigid Formwork

## INTRODUCTION

The last hundred years in civil engineering have been widely dominated by the use of concrete and cementitious materials. Concrete use became so prevalent that it is now the second most consumed commodity after water (Boden et al. 2010). Producing cement, the main constituent of concrete, is an energy-intensive process, which releases CO<sub>2</sub> into the atmosphere during the breakdown of CaCO<sub>3</sub> into CaO and CO<sub>2</sub> and through the burning of fossil fuels to reach necessary calcination temperatures. It is estimated that over 5% of the anthropogenic CO<sub>2</sub> in the atmosphere is attributed to cement production and is the fourth largest source of carbon in the atmosphere. With growing environmental concerns about CO<sub>2</sub> emissions, the construction industry is looking at alternatives both in terms of material and structural systems (Hammond and Jones 2016). The United Nations Environmental Program published in 2016 a report where the question of how to reduce the carbon footprint of concrete is addressed. The main conclusions underline some strategies that can be used to reduce emissions in concrete production like improving the electrical efficiency of plants, to improve the average thermal efficiency of kilns, to further expand the use of pozzolonomically reactive supplementary cementitious materials, such as slag and fly ash, by replacing a portion of Portland cement clinker, and to use cement more efficiently (Scrivener et al. 2016). On the latter aspect, although the cement technology has improved, providing stronger and more durable concrete, the construction techniques have not advanced at the same rate. (Müller and Harnisch, 2008)

Historically, concrete and reinforced concrete structures have been constructed using "rigid" formwork, mainly relying on the use of either straight steel or timber members to generate the required temporary support structure. These construction methods have limited the creativity of design, limiting the structure to, mainly, planar surfaces. The

traditional use of rigid, flat formwork panels has defined reinforced concrete members as a uniform cross-section, prismatic structural elements in both design codes and construction methods. These resultant shapes have become practically an inevitable conclusion for concrete constructions. However, more complex and optimized geometries can be obtained by replacing conventional rigid mold panels with non-rigid membranes. These curved geometries present an opportunity for architectural expression and considerable material-savings through elegant structural optimization by placing material where it is used most effectively. In addition, the amount of formwork material required is also minimized, further reducing the embodied energy of a structure (Hammond and Jones 2016).

## 1.0 BACKGROUND

The use of flexible formwork is not new. Hawkins et al. (2016) presented an in-depth analysis of the current state of the art in flexible formwork technology, highlighting practical uses, research challenges, and new opportunities. Fabric formworks have been used successfully in a wide range of structures since the late 1800s. Many architects, engineers, and researchers have explored the use of such systems (Garbett 2008, Van Damme 2018, West et al. 2007, West and Araya 2009, Orr et al. 2010, Bailiss 2006, Schmitz 2006, Veenendaal 2008), arriving at the conclusion that the following are the main points of concern: (1) *Construction*, specifically on how tolerances in the flexible formwork affect the design outcomes and how they can be controlled; (2) *Materials*, both concrete and internal reinforcement that need to adapt to improve performance in new shapes; (3) *Analysis and design*, to generate realistic computational models that take into account system nonlinearities; (4) *Codes* to optimize concrete structures for safety and consistency; finally (5) *Commercial adoption* and how knowledge should be collated and disseminated to stimulate widespread adoption to produce an environmental impact.

It is clear that much work needs to be done for the further development of this construction method. However, this paper identifies aspects that warrant our immediate attention and present important data on:

- the fabric's quantifiable effects on shape and structural member properties;
- the design, construction, and testing of a mid-scale prototype that deploys the use of non-rigid formwork technology;
- the possibility to minimize the use of internal steel reinforcement with ad-hoc developed concrete mix.

Specifically, this paper wants to address the use of a non-rigid formwork system that has been developed by looking at parameters like mold materials and construction methods. The analysis of a potential flexible formwork is tested, and results are compared to that of rigid formwork. In both typologies, an optimized high-performance concrete mixture developed to take full advantage of the new formwork system is developed to address the lack of internal reinforcement.

## 2.0 NON-RIGID FORMWORK

In contrast to conventional formwork systems, which require molds that do not deform under loading, non-rigid formwork systems embrace these deformations to their advantage. A good way to look at this aspect is by considering the inherent rigidity of formworks and their stiffness,  $k$ . In general, this coefficient varies from zero to one. As formworks approach the upper limit, they become increasingly rigid. As of today, most of the reinforced concrete (RC) applications in architecture and civil engineering rely on the use of concrete formwork with a value of  $k$  close to one (i.e., wood, plastic, and steel formworks). However, in non-rigid formwork systems, the value of  $k$  approaches zero, and the fabric used in the system assumes its final configuration under the concrete generated pressure. This is a non-linear problem as the higher is the pressure generated by concrete in its fresh stage, the higher the fabric deforms, allowing for more concrete to be poured into the formwork. Therefore it is important to investigate the fabric's quantifiable effects on shape and structural properties.

### 2.1 Form

Once a suitable fabric has been chosen, a number of methods are available to determine the final shape of the fluid-filled flexible membrane. Figure 1 reports on a procedure for typology optimization of design-dependent hydrostatic pressure vessels. This iterative process allows to include the nonlinearity within the system in order to compute the final formwork configuration. In general, concrete and cementitious materials in their fresh stage act similarly to a fluid, generating a hydrostatic pressure linearly dependent on their unit weight in any formwork system they are poured. In non-rigid formwork, the fabric under the hydrostatic concrete pressure acts as a vessel and deforms accordingly following a catenary structure's behavior. However, due to the interaction between concrete and fabric and the nonlinearity in the system, the numerical model to describe this phenomenon requires an iterative process.

After defining boundary conditions (i.e., span of a beam, height in a column), and the properties of the materials (steps 1 and 2), we can compute an initial deformation in the formwork depending on stiffness (steps 3 and 4). Although almost any woven fabric can be used as formwork for fabric cast concrete, tensile strengths in both warp and weft directions need to be tested to select materials able to hold wet concrete with a low creep modulus and to limit formwork deformations during casting and curing. In conjunction, properties in cementitious materials will need to be modified to address the new formwork system. Once the deformations are known, the initial volume that the concrete will occupy can be derived, along with its concrete pressure (steps 5 and 6). Based on the maximum concrete pressure allowed in the formwork, new deformations can be computed using fabric material properties (steps 7-12).

The solution will converge the difference in deformation between initial deformation and pressure generated deformation less than 0.5% (step 12), providing the member's final shape. This procedure is based on the work done by Foster (Foster 2010), which used a simple step-wise based method to determine the shape of the concrete-filled fabric iteratively. The complete solution, which requires the use of incomplete elliptic integrals, is given separately by Losilevskii (Losilevskii 2010).

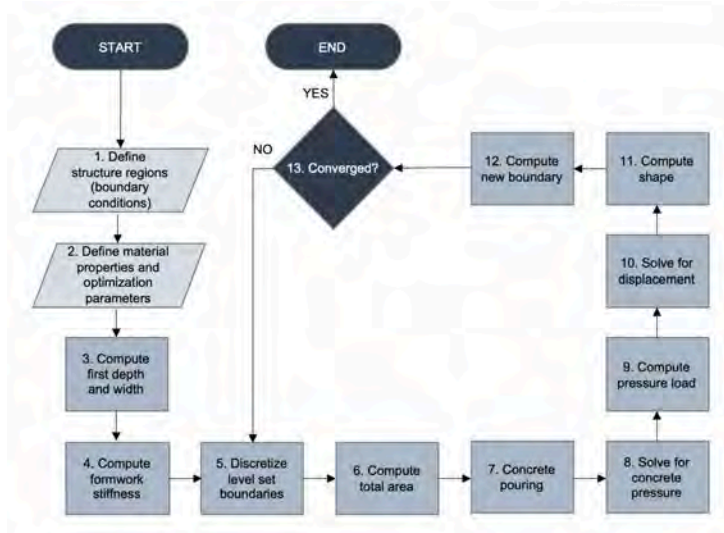


Figure 1: Flowchart of the optimization procedure.

Figure 2 shows the final shape of a reinforced concrete beam designed and constructed using this approach. In this research, beams with this configuration have been built and tested. Results of the investigation are compared to that of a prismatic beam cast using rigid formwork.

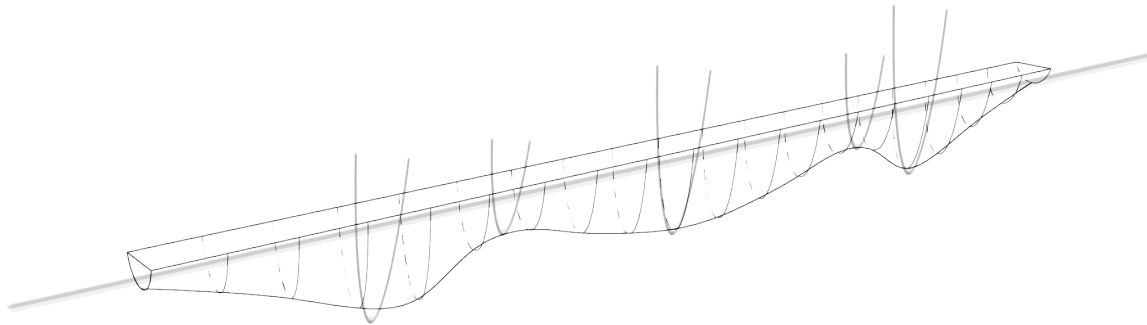


Figure 2: Expected shape of a beam using non-rigid formwork.

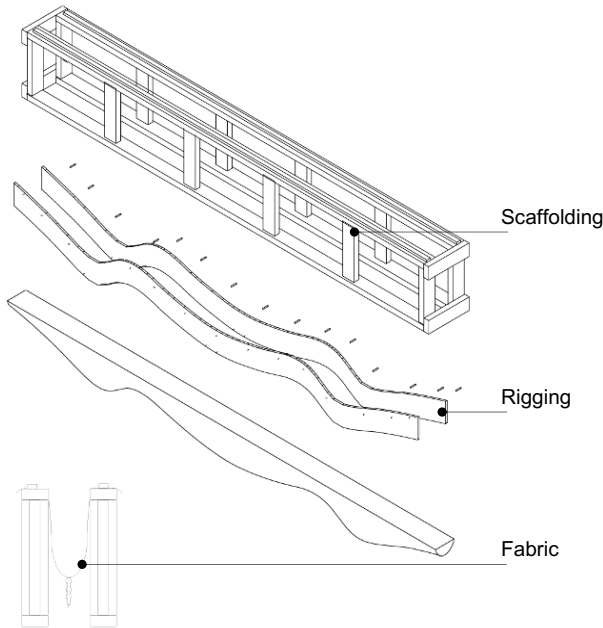
## 2.2 Construction and materials

Three main elements are common to non-rigid formwork: scaffolding, rigging, and fabric (Palagi 2020). The scaffolding is defined as an external and temporary structure erected to resist the rigging's internal tension forces. The riggings mediate the interstitial space between scaffolding and the boundaries. The fabric, held by the rigging, is free to distend as the fresh concrete's lateral pressure consolidates in the encapsulated fabric form (Figure 3).

Scaffoldings are usually reusable elements made of wood or metal. Rigging can vary depending on the structure member that is designed. The available literature illustrates the use of a range of fabrics as formwork, including hessian and geotextiles. In contrast, more recent experimental work undertaken at the University of Bath has used a woven polyester fabric that has previously been utilized in the construction of underwater concrete structures (Forster 2010 and West 2007). Some other common choices are polyesters, vinyl-coated polyester, vinyl-laminated polyester, PVC Fiberglass, PTFE-coated fiberglass, Woven PTFE, and ETFE foil.

In terms of concrete, this paper also explores the use of optimized, engineered cementitious composites that takes full advantage of the formwork system while addressing problems related to reinforcement and construction methods. The

mixture uses several strategies to achieve these results while providing a reduction in cement usage: high percentages of supplementary cementitious materials to reduce the amount of cement; low water/binder ratio to increase compression strength and durability; use of a high range water reducer to improve workability; inclusion of steel fibers to improve concrete tensile capacity. The underlined hypothesis is to minimize the use of internal steel reinforcement with a concrete mix designed to tailor both the tensile strength and the ductility. The mix design is reported in Table 1.



**Figure 3:** Formwork components.

In addition, by allowing the formwork to be flexible, one challenge is related to the rebar configuration, which needs to accommodate a free-forming formwork. The reinforcement of variable section members adds complexity to the construction process yet fundamentally does not differ from an orthogonal structure. By predicting the final shape, a simple bending tool was constructed to fabricate the internal reinforcement.

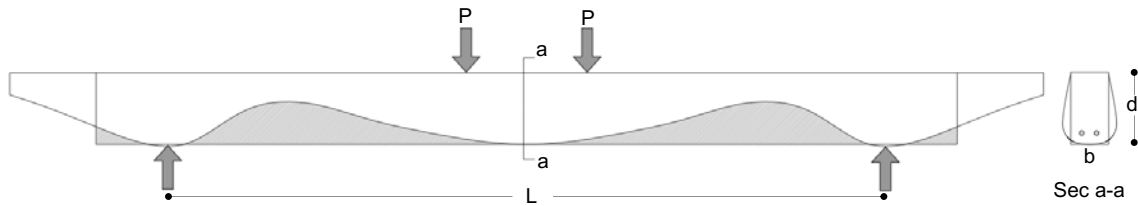
**Table 1:** Optimized concrete mix design

Material	Weight (pcy)]	Ratio by cement weight
Type III Cement	1248	1
Type F fly Ash	387	0.31
Silica Fume	100	0.08
Masonry Sand	1997	1.6
Water	312.25	0.24
HRWR	21	0.016
Steel Fibers	265	

### 3.0 EXPERIMENTAL PROGRAM

#### 3.1 Test matrix

The test matrix was developed to include as test variables the types of materials used as formwork. Three different fabrics (polyester, geotextile, and ETFT) were used in order to investigate the finishing and differences in structural performances. These specimens were structurally compared to a prismatic member with the same span (L) and depth (d) cast using traditional prismatic formwork made out of wood members. The specimen geometry simulated a unit slab strip 55 in long, having a rectangular cross-section 7 in deep and 3.5 in wide. The steel longitudinal reinforcement consisted of two #2 deformed bars designed to ensure an under-reinforced behavior. Figure 4 reports the differences in size, highlighting the material reduction (approximately 30% in volume) between formwork systems. A total of 4 specimens were cast, strengthened, and tested.

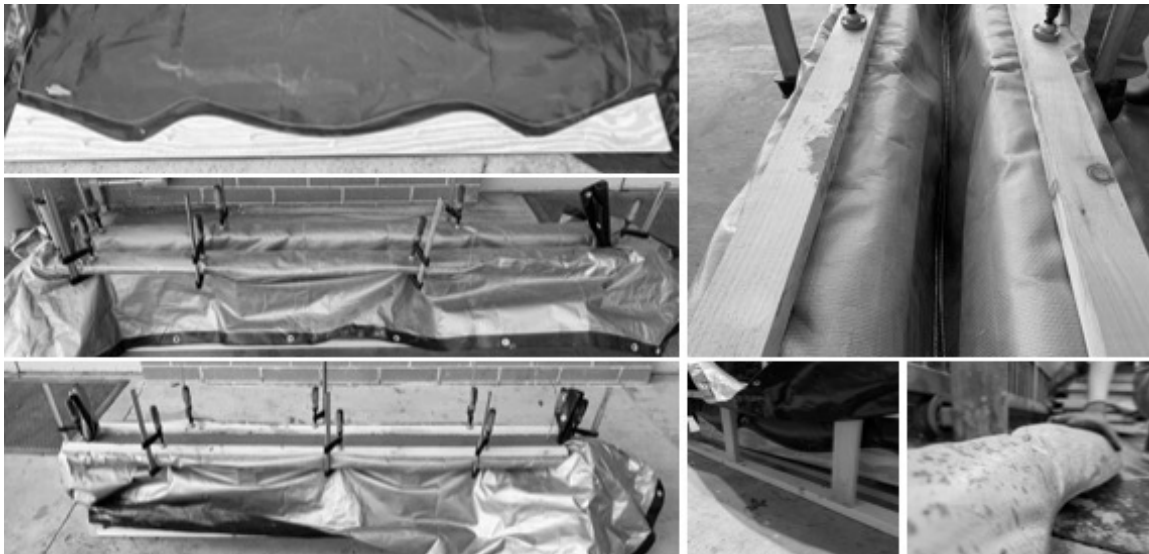


**Figure 4:** Comparison of volume reduction and test configuration.

Load-deflection curves, initial cracking load, ultimate load, and deflection at the initial cracking load and the yielding load were recorded.

### 3.2 Specimen preparation

Beams were cast in separate batches. Specimens were left to cure for over 28 days (Figure 5). The average compressive concrete strength was determined in accordance with ASTM C39 (2020) by testing three cylinders per batch with a nominal diameter of 4 in. for each type of concrete. The average compressive concrete strength of the two batches was found to be 18,225 psi with associated standard deviations of 144 psi. The yield strength of the steel bar was 60 ksi, determined by testing five coupons (ASTM A370 2012) and with a standard deviation of 81,166 psi.



**Figure 5:** Construction details.

### 3.3 Test setup

The type of test performed was a four-point bending test on simply-supported beams over a clear span of 55 in, with 12 in. in the distance between knives centered to the beam and 21.5 in. between support and point of application of the load. The test used a ratio between the depth section and point of application of the load higher than three minimizing the shear contribution in the test and allowing to focus on beams flexure capacity. Testing was performed using a hydraulic actuator with a maximum capacity of 55 kips. The applied load was recorded using both the internal force transducer in the actuator and a load cell placed at one of the supports. Three Linear Variable Differential Transducers (LVDTs) were used to record deflections at the two supports and at mid-span, allowing to compute net deflection. Strain measurements were recorded using six strain gauges bonded in pairs at two different locations: internal steel bars and concrete surface in compression. The gauges were located at the mid-span in the constant moment region. All data were gathered using a National Instruments data acquisition system running LabVIEW software.

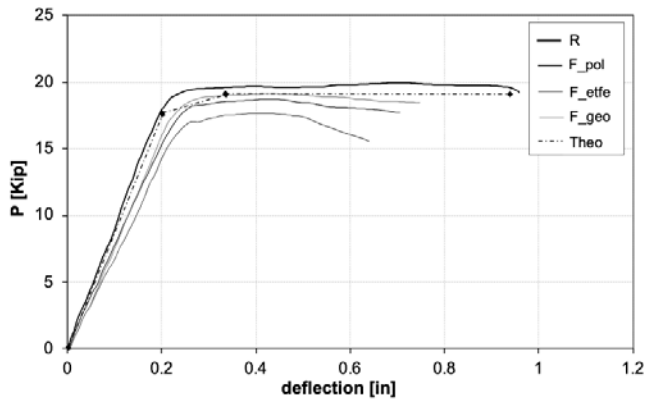
### 3.4 Test protocol

Load was applied in displacement control at a rate of 7.6 mm/min (0.3 in/min) in a quasi-static loading and unloading pattern for a total of seven cycles. The first two cycles were up to concrete cracking, the following two cycles up to yielding of steel, then two cycles up to the clear plastic behavior of the slab, and finally the last cycle to reach failure by concrete crushing.



#### 4.0 RESULTS

A summary of test results for all slabs are displayed in Figure 6. Each curve represents one of the beams cast with different formwork materials and systems. Irrespective of the formwork system, beams with the same level of reinforcement performed similarly. The control specimen reflected the designed under-reinforced behavior, that is steel reinforcement yields before the concrete in compression reaches its maximum usable strain. The failure mode of the fabric beams occurred after steel yielding due to either fabric slippage of the internal reinforcement followed by cracking and crushing of concrete in the areas right outside the constant moment region, where the reduction of the concrete area was more pronounced. In general, beams cast using non-rigid formwork reached the same ultimate value and maximum force, however less ductility due to a shift in the ultimate failure.

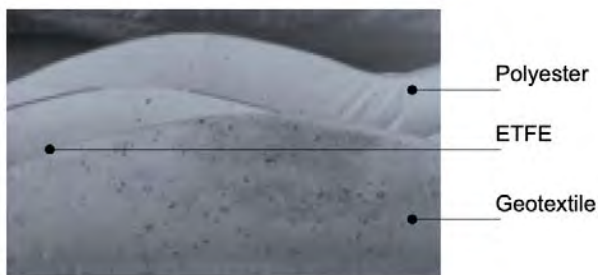


**Figure 6:** Load-deflection diagrams for beams.

In all the cases, the load-deflection relationship was linear elastic up to the point when maximum tensile stress in concrete equaled the modulus of rupture. In this range, the reinforcement's contribution was not affecting the overall beam behavior, and the beam stiffnesses were comparable between the two formwork systems. After cracking but before steel yielding, the relationship between load and deflection was again approximately linear, but with a slightly different slope between the two formwork systems. After steel yielding, the difference in shapes among beams played a more prominent role as the overall ductility of the prismatic beam was considerably higher than the others.

Analytical calculations, according to the ACI 318 (ACI Committee 318, 2018), were developed in order to predict the nominal strength of the FRCM-strengthened slabs. The following assumptions were taken into account: a) plane sections remained plane after loading; b) the bond between concrete and steel was perfect, and c) concrete does not carry any tension. A simple elastic-perfectly plastic model was assumed to describe the steel stress-strain relationship, whereas the concrete stress-strain diagram was modeled through the use of the Todeschini model (Todeschini et al. 1964). Concrete and steel properties are taken from the material test conducted as per ASTM A370 (2012) and ASTM C39 (2012). The tensile yield strength and modulus of elasticity of reinforcements are 60,000 psi and 29,000 ksi, respectively. The compressive strength and modulus of elasticity are 18,800 psi and 7,700 ksi. Results of the analysis are also reported in Figure 6. The experimental results match the analytical model providing valuable information on the overall beams' performance.

Finally, based on the type of fabric, different finishing of the surfaces were obtained. These differences are visible in Figure 7 and could potentially lead to a change in durability performances. However, this aspect was not further investigated as considered outside the scope of the current study.



**Figure 7:** Comparison of fabrics

## CONCLUSION

The results show that using such fabric enhances material reduction and design optimization compared to traditional concrete mold systems while improving sustainability, performances, and adaptation to various architectural forms. By challenging the paradigm of rigid formwork, the result is a technology that impacts the embodied energy and the carbon emission associated with new concrete constructions by possibly saving up to 30% in concrete volume compared to an equivalent strength prismatic member. Thus this research presents results that offer exciting opportunities for engineers and architects to move towards a more sustainable construction industry.

## REFERENCES

- ACI Committee 318. 2018. *Building code requirements for reinforced concrete*. American Concrete Institute, Farmington Hills, MI.
- ASTM A370. 2020. *Standard test methods and definitions for mechanical testing of steel products*. ASTM International, West Conshohocken, PA.
- ASTM C39/C39M. 2012. *Standard test method for compressive strength of cylindrical concrete specimens*. ASTM International, West Conshohocken, PA.
- Bailiss, J. 2006. *Fabric-formed concrete beams: Design and analysis*. MEng Thesis, Department of Architecture and Civil Engineering, Bath, University of Bath.
- Boden, T.A., G. Marland, and R.J. Andres. 2010. *Global, Regional, and National Fossil-Fuel CO<sub>2</sub> Emissions*. Carbon Dioxide Information Analysis Center.
- Foster, R. 2010. *Form finding and analysis of fabric formed concrete beams*. MEng Thesis, Architecture and Civil Engineering, Bath, University of Bath.
- Garbett, J. 2008. *Bone Growth Analogy for Optimizing Flexibly Formed Concrete Beams*. MEng Thesis, Dept for Architecture and Civil Engineering, Bath, University of Bath.
- Hammond, G. P., Jones, C. I. (2016) 'Embodied Energy and Carbon in Construction Materials', Proc. Instn Civil Engrs: Energy, 161 (2), p87-98.
- Hawkins, W.J., Herrmann, M., Ibell, T.J., Kromoser, B., Michaelski, A., Orr, J.J., Pedreschi, R., Pronk, A., Schipper, H.R., Shepherd, P., Veenendaal, D., Wansdronk, R. and West, M. 2016. *Flexible formwork technologies – a state of the art review*. Structural Concrete, 17: 911-935.
- Losilevskii, G. 2010. *Shape of a soft container under hydrostatic load*, Journal of Applied Mechanics, 77/1, 2010, pp.3.
- Müller, N. and J. Harnisch. 2008. *A blueprint for a climate friendly cement industry*. Gland: WWF lafarge conservation partnership.
- Orr, J. J., Darby, A. P., Ibell, T. J. (2010) 'Innovative Concrete Structures Using Fabric Formwork', *SEMC 2010*, Cape Town, South Africa, Sept 4-8.
- Palagi, K. 2020. *Fabric-Lined Tensile Formwork for Cast-in-Place Concrete Walls*. Technology, Architecture, and Design (TAD) issue 4:1 pp. 56-67.
- Schmitz, R. P. 2006. *Fabric formed concrete. 17th Analysis and Computation speciality conference, 2006*. Structures Congress, St. Louis, MO, May 18-20.
- Scrivener, K., V. John, and E. Gartner. 2016. *Eco-efficient cements: Potential, economically viable solutions for a low CO<sub>2</sub>, cement based materials industry*. UNEP (United Nations Environment Program).
- Todeschini, C., Bianchini, A., and Kesler, C. 1964. *Behavior of concrete columns reinforced with high strength steels*. Journal of American Concrete Institute, 61(6), 701-716.
- Van Damme, H. 2018. *Concrete Material Science: Past, Present, and Future Innovations*, Cement and Concrete Research, Elsevier, 112, p 5-24.
- Veenendaal, D. 2008. *Evolutionary optimisation of fabric formed structural elements*. Thesis, Civil Engineering and Geosciences, Delft, University of Delft.
- West, M., Abdelgar, H. S., Gorski, J. 2007. *State of the art report on fabric formwork*. Concrete: Construction's sustainable option, Sept 4-6.
- West, M., Araya, R. 2009. *Fabric Formwork for Concrete Structures and Architecture*, Int. Conf. Textile Composites and Inflatable Structures. Barcelona, Spain, Oct 5-7.



# Plasticized Design: Fusing Plastic Chemistry and Architectural Design to Address Health Impacts

Joiana Hooks<sup>1</sup>

<sup>1</sup>University of Minnesota, Minneapolis, MN

**ABSTRACT:** Globally, 8.3 BMT (billion metric tonnes) of virgin plastic was produced as of 2015, according to Our World in Data. With some utilization spans as low as 12 minutes, reports show 90% of productions were discarded within less than a year; a mere 9% recycled. Subsequently, 4.9 BMT of discarded materials occupy landfills.

Plastic production and disposal methods can cause noxious chemical pollutants. Additionally, disposal methods disregard plastic's useful life, as most endure 400-1,200 years, says ACS Perspective from Chamas et al. This underutilization encourages exponential virgin production, disposal, and pollutants. Closing this "loop" with primary or secondary recycling methods poses equally threatening implications, as both require significant energy/fossil fuels, and water in addition to reinstating noxious chemicals.

Thermoplastics, types 1-7, are the most abundant subset and therefore prioritized for safe mitigation. Due to degradation factors and contamination susceptibility, thermoplastics suffer compositional weakening with repetitive thermal treatments and processing, making cyclical reprocessing difficult, if applicable at all.

Architecturally, thermoplastics are ubiquitous, quickly becoming preferred building/design materials. Currently, architects specify products addressing cost, aesthetic, durability, and performance; "in-use" factors. However, information necessary to comprehensively consider human and environmental health contributors, such as byproducts of plastic's sensitivity to heat and contamination, are not readily accessible, nor intrinsic in specification processes. Ironically, plastics are integral in meeting various Net Zero, Carbon Neutral challenges. Challenges seeking to dispel the very impacts plastics contribute to.

Conveying the exceedingly harmful impacts perpetuated during design detailing/specification processes is key in mitigating unchecked growths of this ubiquitous material. This research proposes a reference specification tool that conveys embodied environmental and human health implications of plastics to AEC designers. Enabling conscious decisions based on factors including Co<sub>2</sub>, GHG, or other VOC emissions, red list chemical presence/exposure, or compositional stability throughout the product's life-cycle.

**KEYWORDS:** Plastic LCA, Synthetic Insulations, Recycling, Plastic in Architecture, Human and Environmental Health

## INTRODUCTION AND CONTEXT TO PROBLEM

Plastics. Can't live with them, can't live without them. We all know and need them, and while some love to hate them, plastics have changed the way we live, affording many advancements in the world of medicine, technology & communication, travel, design, and many others. Despite these evolutions, as we assess areas of human & environmental health or waste management, plastic's once glorified presence now proves more cumbersome in volume, impact, and sustainability.

Cumulatively, the world has produced over 8.3 BMT of plastic as of 2015. Unfortunately, given recycling processes were not abundant nor widely practiced until the early 2000's, nearly all plastic productions were discarded in the interim. As a result, an approximate 6.3 BMT of cumulative primary productions were discarded (Geyer, et al. 2017). These figures are literally and figuratively stifling, especially given their human and environmental health impacts.

### 1.0 PROBLEM DEFINITION: COMPLICATIONS WITH PLASTICS

This research attributes such narrow production and disposal margins to some inherent challenges with plastic's material chemistry. Largely, this research references three simplified facets of a polymer's life that can correlate with production, in-use, and waste management stages: the monomer, stabilized polymer, and the reprocessed polymer (American Chemistry Council, 2018, Hahladakis and Lacovidou 2018). Plastics can generally be described as polymerized monomers, i.e., made chemically available to link. For example, polystyrene, also known as PS or #6 according to Resin Identification Code (RIC), consists of polymerized styrene monomers. Styrene, as a *monomer* and

standalone organic chemical compound, is highly toxic, reactive, and hazardous to human and environmental health if exposed. Though, in the context of a tightly knit polymer chain or *stabilized polymer*, the once volatile compound becomes generally inert, provided the integrity of the polymer chain is maintained. *Reprocessed polymers*, via repetitive reuse, recycling, or product circularity; for those that require thermal treatments exceeding specified thresholds or intensive processing, could endure chain scissions. Leaving room for reactions and harmful by-products to infiltrate and release in the form of various pollutants (Hahladakis and Lacovidou 2018, Hopewell et al. 2009).

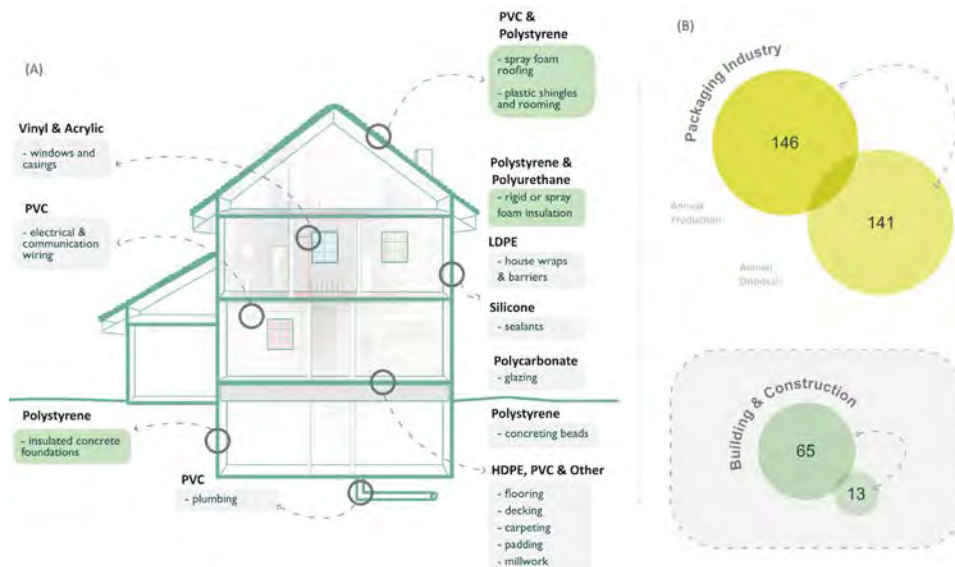


**Figure 1:** Thermoplastic Profile Medallions: Showing (A) Embodied Energy of production, recycling, and molding processes as well as (B) global circulation ratios of annual production, recycling, and disposal with recyclability levels, and decomposition estimations. Source: Content pertaining to diagram was sourced from (Ashby 2013).

For example, primary processing entails remanufacturing recovered products into the same or similar product types, i.e., plastic bottle to plastic bottle, and is only achievable with the purest feedstocks. Comparatively, secondary processing also requires pure feedstock as it entails remanufacturing recovered products into new products. Although, due to the additional performance features required to satisfy the new product life, additives are often utilized to enhance the recovered product. These additives diminish the purity of the feedstock over time and thus decrease the product's continued applicability for reprocessing and increase the product's potential pollutants (Hahladakis and Lacovidou 2018, Hahladakis et al. 2018). Ultimately deeming the products to be disposed of. Both of these complications are most pertinent at the point of processing, during the material's end of life/reuse phase, making proper and advantageous utilization during the material's in-use phase crucial.

### 1.1. Analyzing the Problem: Plastics in Architecture and Misaligned Use

Currently, plastic products are not being utilized to their material capacity, and, existing across industries, is a significant misalignment of product use life to product material life span.



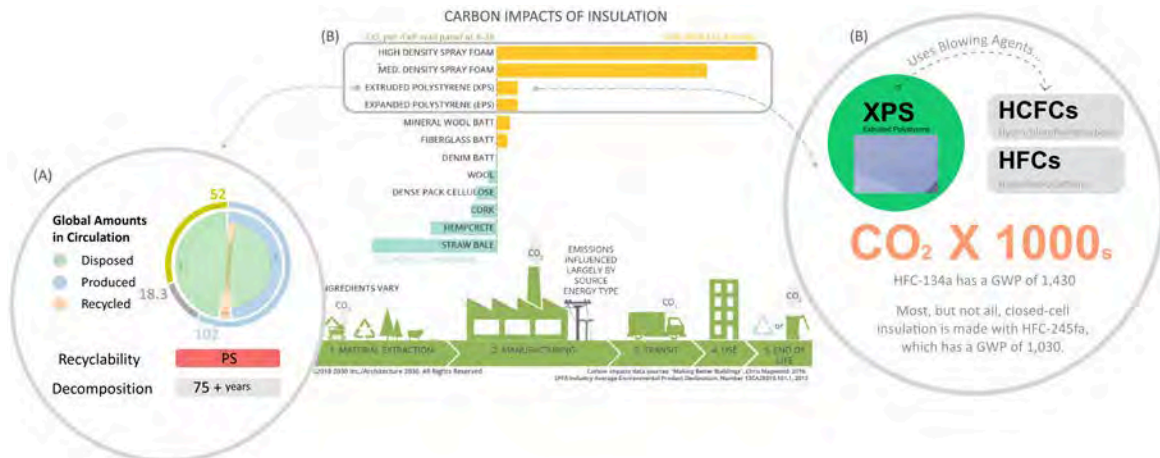
**Figure 2:** Diagram of (A) plastic design applications within architecture and (B) annual plastic production/disposal allocations per industry. Source: (A) Modified from Building with the Power of Plastics (American Chemistry Council). (B) Modified from Science Advances, (Geyer, Jambeck, and Law 2017).

Architecturally, plastics are ubiquitous, quickly becoming a preferred building/design material (Geyer, Jambeck, and Law 2017, Hahladakis et al. 2018). From building elements and materials throughout Core & Shell to interior finishes, plastics are used extensively. Accounting for the second-largest annual allocations of plastic production at 65 million tonnes produced to 13 million tonnes disposed of (Geyer, Jambeck, and Law 2017), it would seem the building and construction industry has successfully addressed ideal utilization spans, but this is not the case. Studies show plastics

subside for 10-450 years with little to no sign of biodegradation, most not anticipated to degrade for 1,000 plus years, if ever depending on environmental conditions (Clunies-Ross et al. 2019). On the other hand, built environments are made to last several decades which is a step in the right direction as this keeps products in circulation. Though, the industry still positions a 1,000-year product within a 30 to 50-year application (Geyer, Jambeck, and Law 2017). Which, given renovation and demolition procedures are not careful to recover most products for reuse, utilization of the product lasts for a meager 3-5% of its potential life span and often prompting any remaining useful life to subsist within landfills and dumps. Both of which are areas in which hazardous human and environmental impacts and pollutants can derive (Canopoli et al. 2018, Clunies-Ross et al. 2019). Ultimately, there exists a disconnect between the material's longevity and durability, and the material's design application or use.

The overall goal of this investigation is to create a tool to address this disconnect by targeting AEC designers. Currently, designers specify products addressing cost, aesthetic, durability, and performance; "in-use" factors. Though, the suggested evaluation tool also allows for decisions that are ethically responsible or sustainable. A balance of in-use and ethical factors is especially pertinent to architects, as they are obligated to uphold industry standards. Canon VI of the AIA Codes of Ethics and Professional Conduct outlines the Architect's Responsibility to the Environment, requiring designers to strive for greenhouse gas reductions, water conservation and quality, reduced exposure to toxins/pollutants and waste, the maintenance of healthy surrounding ecosystems and environments, as well as to be prepared to combat adverse effects on public health.

While in an ideal position to enact change, beyond in-use factors, designers are not fully knowledgeable of the materials they are designing with and therefore are not fully equipped to specify materials for design applications in the context of human and environmental health. This research found current design/impact tools and specifications to be limiting, as no one tool was comprehensive enough to include implications pertinent to all stages of the product's life, beyond in-use. Thus, leading to incomplete and uninformed decisions.



**Figure 3:** (A) Global circulation amounts of Polystyrene including recyclability and decompositions time (in a perfect condition). (B) Diagram showing Carbon Impacts of Insulations (Magwood 2016). (C) Off-gassing of blowing agents used in XPS insulations. Source: Modified from, Making Better Buildings (Magwood 2016).

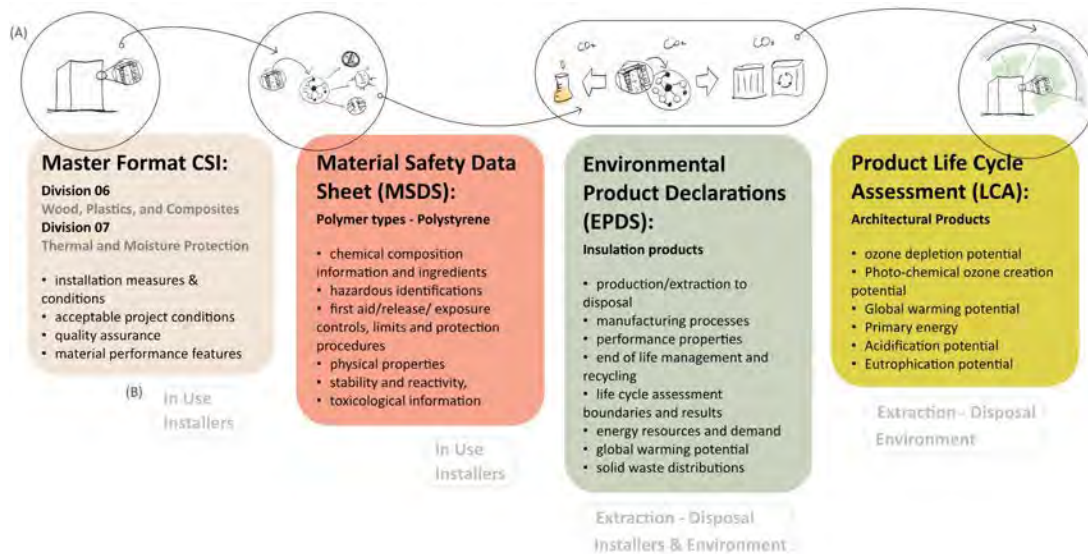
Such is the case of plastic-based insulations, which are the focus of this study. These products provide significant benefits as they enable energy and therefore emission reductions. Various energy standards, such as Energy.gov, or Polyurethanes Excellence in Insulation note the most feasible and economical action to take to reduce fossil-fuel-derived energy and subsequent CO<sub>2</sub> emissions is to increase insulation amounts (Simona, Spuru, and Ion 2017), resulting in potential reductions of 10% or higher (Adan and Fuerst 2016). The information omitted in this instance is the impact of the insulation itself. Not only can plastic-insulations have significant carbon footprints, at 1,000s of lbs for every 32 sqft (Magwood 2016), but, included in the most commonly used insulation materials are polyiso and polystyrene-based insulations (Energy.gov 2021). Polystyrene foams, EPS (expanded polystyrene), and XPS (extruded polystyrene) are made from the highly toxic, carcinogenic chemical styrene (Styrene Monomer SDS 2020). Not only is polystyrene very difficult to recycle, but it is also doesn't degrade for centuries, if at all (Clunies-Ross et al. 2019). Furthermore, according to AirFoam's EPS and XPS Insulation Comparison: Environmental Impacts Ingredients & Properties, most XPS insulation utilizes blowing agents HCFCs (hydrochlorofluorocarbons) and HFCs (hydrofluorocarbons) that have been proven to be 1,000 times as potent as carbon and other Greenhouse gases. Depending on the specific grade of HCFCs/HFCs, that number can be even higher, and unfortunately off-gas throughout the life of the insulation, contributing significantly more to ozone depletion, global warming, eutrophication, and acidification amounts than other plastic-based insulations (Airfoam 2020). This is the type of information and impact



this research seeks to enable designers to consider when specifying products, as these highly potent blowing agents have subsequent effects on people and the environment long term.

## 2.0. METHODOLOGY: ASSESSMENTS, DESIGN AND FRAMEWORK FOR TOOL

The methodology used to establish the framework for the comparative impact tool included analyzing current design specifications tools for information on health impacts. This suggested tool would combine aspects of material chemistry, life cycle processes, design application, waste management treatments, as well as human and environmental impacts. By assessing human and environmental health implications at every stage of a product's life and compiling this interdisciplinary data into a digital matrix-based interface, this tool will convey various embodied impacts present and or induced throughout the product life cycle. This study found this information dispersed among several sources and venues including Environmental Product Declarations (EPDs), Master Format CSI Division Specifications, Life Cycle Assessment (LCA) reports, Chemical Red Lists, and Material Safety Data Sheets (MSDS).



**Figure 4:** (A)

4-part comparative diagram showing main content included within current architectural product impact and specification tools assessed for research. (B) Emphasizes which point in the product life cycle these tools target or include, as well as who/what the tools target or effect.

### 2.1. Assessment of Environmental Product Declaration

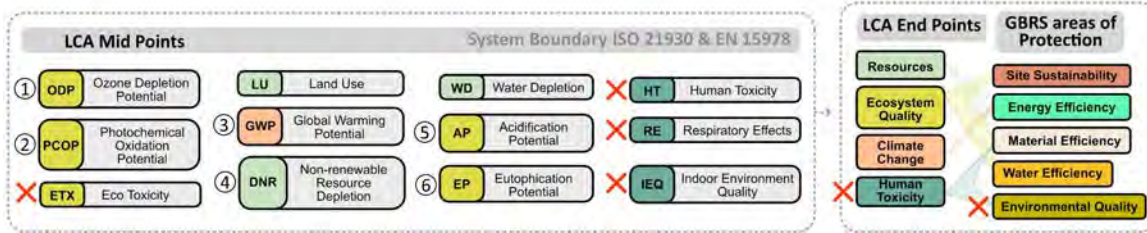
When assessing Environmental Product Declarations (EPDs), the scope of focus extends from production/extraction to disposal. Highlighting manufacturing processes, performance properties, end of life management and recycling, life cycle assessment boundaries and results, energy resources and demand, global warming potential, and solid waste distributions. This tool effectively addressed aspects of environmental impacts, and waste distributions though did not include factors of proper recycling or effects of waste distributions.

### 2.2. Assessment of Master Format

Throughout assessing Master Format Divisions 06 (Wood, Plastics, and Composites) and 07 (Thermal and Moisture Protection), most of the specification's focus was found around installation measures and conditions, acceptable project conditions, quality assurance, and material performance features. This tool effectively addressed aspects of design performance, features and durability, though was missing aspects of human and environmental impacts and material composition factors/byproducts.

### 2.3. Assessment of Life Cycle Assessment Reports

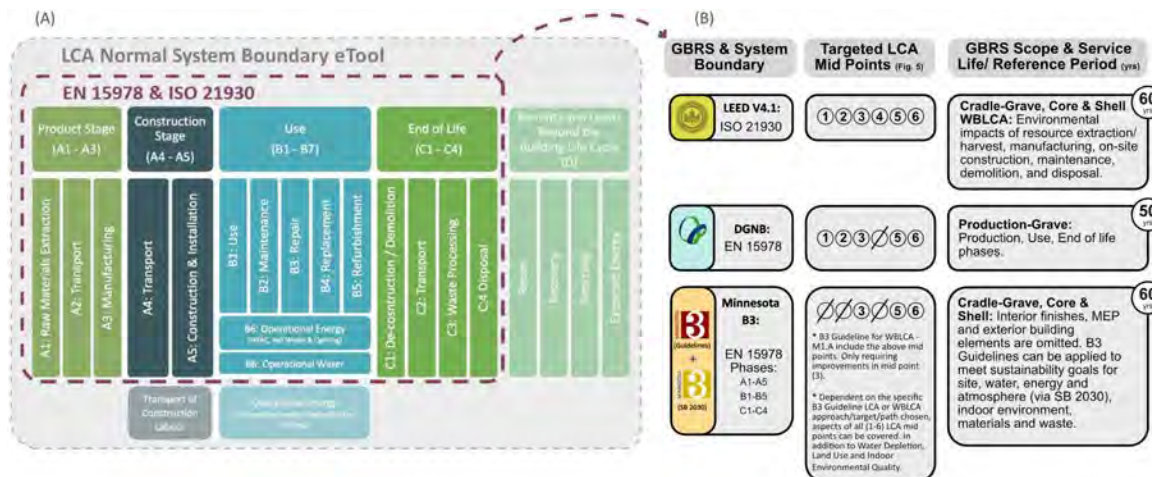
Tools and assessment criteria of LCAs and WBLCA (Whole Building Life Cycle Analysis) were analyzed. While an LCA examines environmental impact of a product's life cycle, process, or service. A WBLCA mimics the process an LCA, while also holistically considering the *whole building* project in order to direct the designer's focus and effort toward reduced footprints and other respective performance aspirations. Both are conducted according to various system boundaries and standards, whereas this study includes ISO (International Organization for Standardization) 21930 and EN 15978, which mainly target 6 mid-points that all deal heavily with ecosystem quality, climate change and resources. Though, nothing directly addressing human toxicity or eco-toxicity (Fig. 5). With these midpoints excluded from the assessment's parameters, the designer's holistic analysis of a product is once again limited and even distorted.



**Figure 5:** A diagram showing inclusion and exclusions of LCA Mid/End Points that are included within LCAs based on ISO (International Organization for Standardization) 21930 which provides the principles, specifications, and requirements to develop an (EPD) for construction products, and or EN 15978, which measures the sustainability of construction works and assessments of the environmental performance of buildings.

Using three GBRs (Green Building Rating Systems) as vehicles to study WBLCAs exclusively, LEED (Leadership in Energy and Environmental Design) V4.1, DGNB (English translation: German Sustainable Building Council), and Minnesota B3 Guidelines were examined, each varying in governing system/standard, targeted mid points and parameters. Once again exemplifying how current tools would hinder a designer’s informed and holistic assessment as each omit different implications and life cycle stages pertinent for consideration.

Similarly, for LCAs and WBLCAs alike, applicable scopes generally extend from cradle to grave or Product Stage to End of Life (A1-C4, Fig.6), excluding reuse, recovery and recycling within the Benefits and Loads portions of the life cycle (D, Fig.6).



**Figure 6:** (A) A diagram depicting main categories and subcategories of each life cycle stages included within LCAs based on ISO (International Organization for Standardization) 21930 and or EN 15978. (B) Accompanied by a diagram highlighting various GBRs used to conduct WBLCAs. Showing which System Boundary is adhered to, which 6 mid points are addressed, as well as the assessments scope/parameters and assessment reference period. Source: (A) modified from eTool.

These exclusions are crucial being that landfill diversion and reuse are major goals and points of contention especially for plastic products. Also, the end-of-life stages of the boundaries do not assess byproducts nor potentially hazardous outcomes from the disposal and degradation of assessed products. Which, given what is now known about plastic’s susceptibility to contamination and chain scissions, these potential outcomes are of note, especially towards human and environmental health impacts.

### 2.4. Assessment of Red Chemical List

The Living Building Challenge (LBC) Red List includes a master list that addresses the "worst in class" materials, chemicals, and elements that are prevalent in the building products industry. Items on this list are known to pose serious risks to human and environmental health. While this list sufficiently covers materials, their embodied impacts are not addressed.

### 2.5. Assessment of Material Safety Data Sheets

When assessing Material Safety Data Sheets (MSDS) for plastic products, most of the focus was found around chemical composition information and ingredients, hazardous identifications, first aid exposure controls, limits and protection procedures, physical properties, stability and reactivity, as well as toxicological information. This tool is effectively addressing aspects of chemical properties as well as any subsequent impacts or characteristics, though is missing factors of product endurance, or aspects of safe and circular reuse.

## 2.6. Compilation of Assessments and Design of the Tool

To convey these layers of information in an easy and digestible way for designers, the suggested tool uses a simple product grading system. Each product will be rated by taking an average of the total marks against them to then produce an impact score from slight, to moderate, to severe. The marks will be housed under a people, and an environment section for each stage of the product life cycle, from extraction to recycling.



**Figure 7:** This figure is showing the rating system behind the, slight, moderate, or severe, denoted as a “3-dot” impact score. This is referenced for each corresponding People and Environment sections throughout the tool.

In each people category, the marks against the product include the product’s direct exposure, indirect exposure and overall Material Health which was adopted from Cradle to Grave Certification Standards. The standard describes Material Health as:

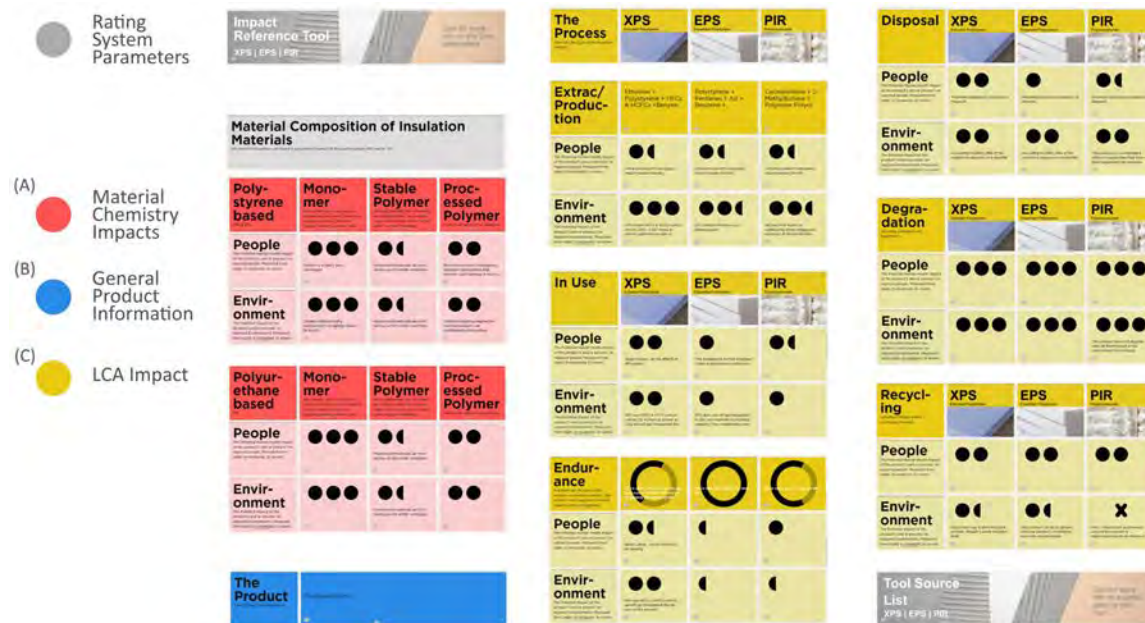
Material Health: Chemicals and materials used in the product are selected to prioritize the protection of human health and the environment, generating a positive impact on the quality of materials available for future use and cycling.

Additionally, in each environment section, there are marks for the number of LCA categories over 70%; referring to the 6 midpoint categories in (Fig. 5), as well as marks for adverse land use such as landfilling, or chemical washing that can sometimes infiltrate bodies of water. Lastly, there are marks against the product if the particular life cycle stage/process implicates the material's chemistry. An example of this would include disposal and recycling, which potentially disrupt the polymer chain.

Along the X-axis, from a high level, this tool is addressing 3 main areas starting with insulation's material chemistry (Fig. 8), which is outlining the human and environmental impacts of the polystyrene for EPS and XPS, as well as Polyurethane for Polysio foam insulation. In this section, we can refer to the fundamentals of plastics; monomers, stabilized polymer, and the processed polymer.

The next major area this tool is addressing is the process and life cycle of the product (Fig. 8), found along the Y-axis. This includes extraction, in use, endurance, disposal, degradation, and recycling. This is the section designers will most interact with, and therefore the ratings are quickly showing any bearing on human and environmental health for each lifecycle stage, again from slight to moderate, to severe. The idea is to





**Figure 8:** Starting with (A) and (B) are images of the 3 landing pages of the tool. (A) includes the material chemistry of the plastic in which the insulation is based. This section shows impacts for 3 stages of the material (along top x-axis). (C) This section of the tool shows the impact of human and environmental impacts of each insulation (along top, intermittent x-axis) applicable to each stage of the product's life (along y-axis).

have designers first interact with a high-level comparison of insulations. For further information on each product's respective sections or the specific basis of the 3-dot rating, the tool expands to provide additional context.

### 3.0 OUTCOMES: USER-TESTING RESULTS, CONCLUSIONS, AND LIMITATIONS

According to the initial quantified impacts on the landing page of the tool (Fig.8), totaling each section's rating from 1-3, XPS is the most impactful at 25.5 total impacts graphically denoted by dots. Next is PIR at 22.5, and EPS at 19.5. Users are able to make design decisions from these sums alone, or they can expand the tool and access information about the measured impact within the most pertinent section of the life cycle for them and their project.

The initial round of user testing was conducted by interviewing two architects that serve as project directors or managers and have the responsibility for material specification. Architect A was very familiar with specification writing and knowledgeable of insulations. Architect B was an internationally recognized thought leader on sustainability and evidence-based design. Both participants were briefed on the intent of the tool, as well as how to use the tool, which was followed by a semi-structured interview.

During the interview with Architect A, the dialogue included practicalities of conveying the information and impact to designers who were concerned with the performance specifications of insulation, R-values, thermal conductivity, etc. A potential resolution to the comment involved expressing a stronger position on each insulation's impact, good, bad, or otherwise. They predicted 1 type of user of this tool would be an architect who is working on multiple projects and specifying various products for each project and would therefore benefit from a quick, qualitative judgment to expedite their decision making. Also, this study was small in scope, with three insulations types included the suggestion of expanding the study to include all insulation types and additional products in the future was well taken, and a future goal as the research progresses.

Architect B questioned how to more adequately convey and track the cause and effect of impacts amongst a plethora of materials used within a building; what they described as a "complex mess," proposing these future additional materials could undergo this same extensive analysis. Along this same line, when considering the people sections of the tool, more specificity of impacted persons and how to track the various vehicles of exposure came into question. MSDSs expand on human exposure effects within toxicological sections, and while it can be assumed that the main persons likely to be exposed are those installing/renovating/demolishing the material, there are no specifics on age groups or type of people the exposure study included for analysis. This opened the doors to what tracking of exposure impacts could look like, as it is not just limited to installation/renovation/demolition settings, but could occur once

installers leave the site and interact with their families, wash their work clothes, etc. Additional feedback included potential next steps, such as exploring what this study could look like if applied to assemblies, tracking any implications a typical wall section encompassing these insulations could have. Also testing the 3 included insulations types against other eco insulations was predicted to provide more context of impacts for both types and viable options.

In conclusion, this research establishes a comparative specification tool that cultivates awareness, knowledge and understanding of design product and application impacts and enables AEC designers to make responsible, long term, design decisions for human and environmental health.

## REFERENCES

- Adan, Hassan, and Franz Fuerst. 2016. "Do Energy Efficiency Measures Really Reduce Household Energy Consumption? A Difference-in-Difference Analysis." *Energy Efficiency* 9 (5): 1207–19. <https://doi.org/10.1007/s12053-015-9418-3>.
- Airfoam. "EPS and XPS Insulation Comparison." *Airfoam Expanded Polystyrene Solutions*. Accessed 2020. <https://airfoam.com/EPS-vs-XPS-Foam-Insulation.php>: Airfoam
- American Chemistry Council. 2018. *How Plastics Are Made, the basics: polymer definition and properties*. <https://plastics.americanchemistry.com/plastics/The-Basics/>: American Chemistry Council.
- Ashby, Michael F. 2013. "Chapter 15 - Material Profiles." *In Materials and the Environment*, 459-595. Second ed: Elsevier.
- Baumgart, Ian. 2019. *Plastics in the Environment: Te Ao Hurihuri-the Changing World: Evidence Summary*. <https://www.royalsociety.org.nz/what-we-do/our-expert-advice/all-expert-advice-papers/plastics-in-the-environment-evidence-summary/>: Royal Society Te Apārangi.
- Canopoli, L., B. Fidalgo, F. Coulon, and S. T. Wagland. 2018. "Physico-Chemical Properties of Excavated Plastic from Landfill Mining and Current Recycling Routes." *Waste Management* 76: 55–67. <https://doi.org/10.1016/j.wasman.2018.03.043>.
- Energy.gov. *Insulation Materials*. <https://www.energy.gov/energysaver/weatherize/insulation/insulation-materials>: U.S. Department of Energy.
- Geyer, Roland, Jenna R. Jambeck, and Kara Lavender Law. 2017. "Production, Use, and Fate of All Plastics Ever Made." *Science Advances* Vol. 3 no. (7). <https://doi.org/10.1126/sciadv.1700782>.
- Hahladakis, John N., Costas A. Velis, Roland Weber, Eleni Iacovidou, and Phil Purnell. 2018. "An Overview of Chemical Additives Present in Plastics: Migration, Release, Fate and Environmental Impact during Their Use, Disposal and Recycling." *Journal of Hazardous Materials* 344: 179–99. <https://doi.org/10.1016/j.jhazmat.2017.10.014>.
- Hahladakis, John N., and Eleni Iacovidou. 2018. "Closing the Loop on Plastic Packaging Materials: What Is Quality and How Does It Affect Their Circularity?" *Science of The Total Environment* 630: 1394–1400. <https://doi.org/10.1016/j.scitotenv.2018.02.330>.
- Magwood, Chris. 2016. "Making Better Buildings. A Comparative Guide to Sustainable Construction for Homeowners and Contractors." <https://materialspalette.org/insulation/>: New Society Publishers & 2030 Inc./Architecture 2030.
- Polyurethanes Excellence in Insulation. Benefits of Insulation: *Providing Economic Benefits*. <https://highperformanceinsulation.eu/home/benefits-of-insulation/providing-economic-benefits/>: PU Europe.
- Rodriguez, B X, and K Simonen. 2018. *Comparison of Methodologies for Whole Building Life Cycle Assessment: A Review*. Carbon Leadership Forum.
- Shell Eastern Chemicals. 2020. *Styrene Monomer Safety Data Sheet (SDS) No. Q9211, Q9215, Q9257 [Online]*. Shell Eastern Trading (PTE) LTD (UEN:198902087C), The Metropolis Tower 1 Singapore 138588. [https://ch-msds.shell.com/MSDS/000000000847\\_AU\\_EN.pdf](https://ch-msds.shell.com/MSDS/000000000847_AU_EN.pdf): Shell Eastern Chemicals.
- Simona, Paraschiv Lizica, Paraschiv Spiru, and Ion V. Ion. 2017. "Increasing the Energy Efficiency of Buildings by Thermal Insulation." *Energy Procedia* 128: 393–99. <https://doi.org/10.1016/j.egypro.2017.09.044>.

# Investigating Scales of Performance: Mycelium Ecomanufacturing in Dhaka's Urban Settlements

Iffat Ridwana<sup>1</sup>, Mae-ling Lokko<sup>2</sup>

<sup>1</sup>University of Cincinnati, Cincinnati, OH

<sup>2</sup>Rensselaer Polytechnic Institute, Troy, NY

**ABSTRACT:** With a human population density 1.36 times higher than Mumbai (32,300) and 24 times higher than New York (1800), Dhaka the capital of Bangladesh, is the world's densest metropolitan city at 44,000 people per square kilometer. Dhaka's high-density "informal" urban settlements embody unique formal characteristics, microclimatic conditions, scales of biomass waste production, and labor patterns that activate new opportunities for ecomanufacturing. This paper investigates two scales of performance in the built environment including the potential of dense urban settlements to *perform* as urban production centers for emerging bio-based mycelium technologies, using organic wastes as a renewable material feedstock; as well as the material *performance* of derivative bioproducts. This form of ecomanufacturing leverages the variation of spatial planning, environmental patterns, and materials of development in informal settlements, alongside the workforce organizations in a case study area of Dhaka, Bangladesh. To characterize the material performance of derivative products, a literature review evaluating the compositional ratios of organic food and agricultural wastes available in the case study urban settlement was done and this study includes (i) mechanical tests on biocomposites developed with a range of pilot organic food waste, agricultural waste and invasive species substrates performed according to ASTM D-1037 Standard and (ii) thermal conductivity and hygric characterization of optimized mycelium biocomposites according to ASTM standard C518 and ASTM E96 standards respectively. Design strategies for matching microclimatic conditions and passive energy flows to the production stages of mycelium bio-composites within the dense urban settlements are explored, and finally, the interior conditions of designated ecomanufacturing spaces within a case study building cluster are investigated using Energy Plus simulation software. The spatial and construction material analysis in the case study area showed significant opportunities to develop this production process in comparative social and economic contexts. This distributed waste transformation over time has the potential to extend ecomanufacturing beyond the borders of informal urban settlements to serve as a highly integrated ecomanufacturing service for intersectoral waste resources in urban communities.

**KEYWORDS:** informal settlements, waste transformation, ecomanufacturing, mycelium biocomposites

## 1.0 INTRODUCTION

Developing countries have demonstrated comparatively high growth population rates of 2% compared to only 0.5% in developed regions over the last century (UNDP, 2018). The rate of increasing population has led to mass proliferation of dense urban "informal" settlements which currently house almost a billion people around the world (Mahabir et al., 2016; UNDP, 2018). Informal settlements are residential areas with low-security levels of tenure, basic services, and poor infrastructure ((UN-Habitat III, 2016). However, such "informal" settlements embody the speculative and strategic decisions of inhabitants, and therefore not entirely unplanned (Counihan, 2017). Construction materials in these settlements are mainly recycled materials with limited durability and permanence which lead to dense horizontal expansion over the land. In addition to this, the prevalent economic vulnerability contributes to the marginalization of these individuals. Therefore, such settlements in developing contexts have become a critical site for investigating unique urban planning and management innovations (Ridwana, 2019). Alongside these challenges within high-density urban settlements in developing countries; population and urbanization have also lead to the increase of waste generation. It is projected that by 2050, developing contexts will generate the majority of waste in the world (Kaza et al., 2018), with over 50% produced from food and organic wastes. This study investigates how inhabitants within informal settlements can play a major role in the waste management system alongside expanding the opportunity for income generation.

### 1.1. Dhaka: A case study of high density, urban settlements & municipal solid waste management

With a human population density 1.36 times higher than Mumbai (32,300) and 24 times higher than New York (1800), Dhaka the capital of Bangladesh is the world's densest metropolitan city at 44,000 people per square kilometer. As a lower-middle-income country with an annual population growth of 4.2% (UN Habitat, 2014; Dhaka Population, 2019), the consistent scale and volume of this city's waste resources represent an opportunity to rethink waste management within the environment of dense urban contexts. Most of the municipal solid waste generated comes from the residential sector which constitutes 77% of organic and food waste (Waste Concern, 2014). Recently, the government



has proposed an allocation of two new landfill sites in the outskirts of Dhaka, and such landfill practices have led to an increase of CO<sub>2</sub> emission from 304.25 kg to 380.07 kg per household per annum between the years 2005 to 2014 (Waste Concern,2014). **Figure 1** shows the current scenario of municipal solid waste in Dhaka city.

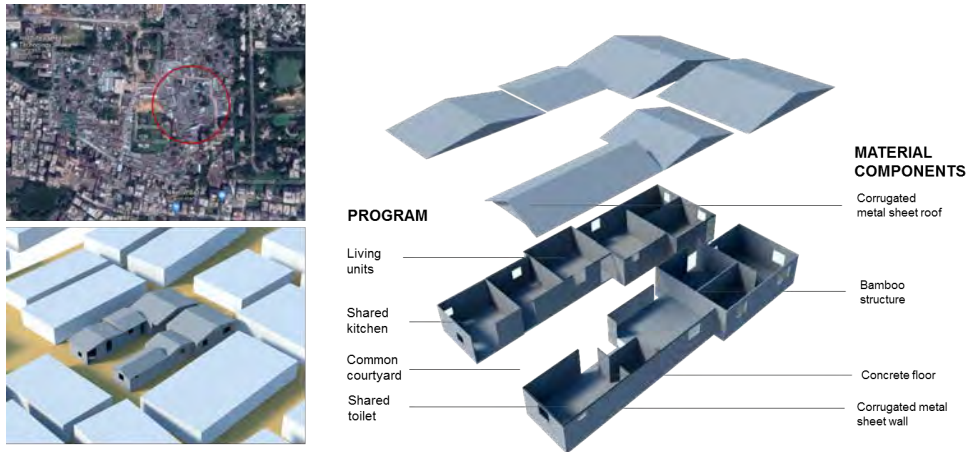


**Figure 1:** Current scenario of municipal solid waste in Dhaka (Ridwana, 2019)

Population expansion and rapid rural to urban migration have led to numerous informal settlements inside the city which house 3.4 million of the city's 9 million people (Mohit, 2012). Several studies show that the primary reason for migration is the better economic opportunities in the city. Many large slums have expanded over the years with evictions to upgrading and development projects to provide basic services. Although these projects ensured access to water, electricity, and latrines to most of the informal settlements' inhabitants, more than 50% of these settlements do not have a designated garbage disposal and mechanism of waste collection yet (Mohit, 2012). The dumping of waste occupies all the remaining open spaces inside the informal settlements, and this is exacerbated by the problems associated with solid waste such as odor, contamination of waterways, and transmittance of disease, directly affecting the inhabitants every day.

Mohakhali Shattola slum, in the heart of Dhaka city, is surrounded by dense commercial, residential and public spaces and this was selected as a case study in this paper. From a field survey performed in 2015, different arrangements of the clusters of living units were investigated in this informal settlement most of which consists of a shared service space with kitchen, toilet, and wash area facilities among 4-6 units of family and common circulation or courtyard space. **Figure 2** shows an arrangement of a cluster in Mohakhali slum. It was found that most of the families include 4-7 members, living in one single unit in a cluster. The monthly income for each family varies from USD 12 to 250 and the main form of employment is temporary day-to-day jobs including manual laborers, small-scale traders, and transporter, domestic help as well as garbage collectors. This study also shows that in terms of basic services, waste management is a major concern for the inhabitants. However, some inhabitants are already engaged in the waste recycling trade chain and participate in communal garbage collection. This creates a scope of intervention where a participatory framework of upgrading can be developed along with existing systems of waste management.

Building on recent innovations in cradle-to-cradle material design frameworks, fungi were investigated as living material technology for the production of bio-based materials from waste streams. Saprophytic fungi produce a complex network of microscopic filaments (hyphae) while they digest the lignin and cellulose content of plant matter and comprise of the vegetative part of fungi known as fungal mycelium. This three-dimensional network of mycelium works as a matrix that binds pieces of organic substrates together without any synthetic adhesives, forming a lightweight biocomposite (Attias et al., 2017). Over the last decade, mycelium-based biocomposites have been used to manufacture a wide range of products varying from lightweight packaging (Ecovative) to wearable leather (Mycoworks). Most of the commercial companies working with these composites rely on locally generated agricultural residues like fibers, straws, hurds, etc. However, there remains the scope of research for waste residues that can be beneficial for the growth of mycelium biocomposites. Organic food waste percentage in the waste composition of Dhaka presents a research opportunity of waste transformation with fungal mycelium to generate a system based on the supply chain of waste in the case study context. So, this paper explores the transformation of organic waste using mycelium biocomposites and the integration of the production process of these biocomposites into informal settlements leveraging the site and climatic passive energy resources. This proposed framework utilizes the manufacturing of mycelium biocomposites in the case study context to generate employment for the informal settlement inhabitants which can create a local and global market of these composites.

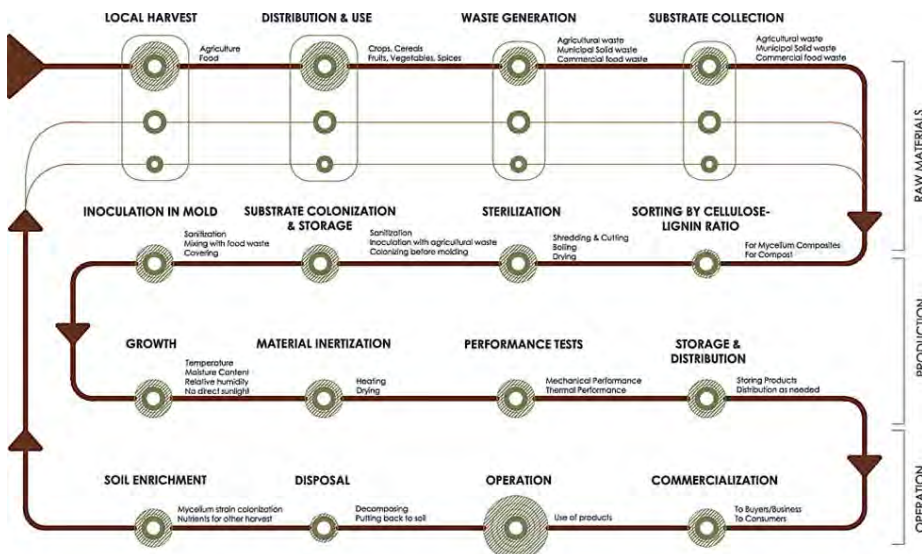


**Figure 2:** The urban context of Stattola slum (Top left), Aerial view of housing cluster (Bottom left), Programmatic and material assembly components of housing cluster (Right).

## 2.0 METHODOLOGY

### 2.1 Production lifecycle and substrate composition

The production of mycelium bio-composites includes specific stages where mycelia are grown to create a lightweight, low-density composite and dried-out before the generation of 'fruiting bodies' or what usually are called mushrooms. **Figure 3** shows the stages of production considered for commercial mycelium-based biocomposites (Modified after, Girometta et al., 2019). For waste substrates, local harvests, seasons, and their amount of production in the case study context were collected during the year 2017. Usually, substrates with polysaccharides which are high in cellulose and lignin are preferred for ideal growth of fungal mycelium as many other species cannot break down cellulose easily, making it easier for the mycelium to grow (Silverman, 2018). A comparative study of cellulose and lignin percentage in substrates commercially used and available in Bangladesh was done before the development of mycelium biocomposites.



**Figure 3:** Production stages of mycelium bio-composites (Modified after, Girometta et al., 2019)

### 2.2 Low-density myco-composite development from case study biomass waste-streams

The goal of myco-composite development with case study biomass wastes was to investigate the relationship between the compositional mass of waste and the mechanical performance consistency of those myco-composite boards. Using a commercial mycelium-substrate mixture developed by Ecovative Design LLC; a biomaterial company based in New York, low-density myco-composites were developed consisting of three sources of lignocellulosic wastes as well as variable cellulose and lignin ratios –food waste, agro-waste, and invasive species. Lemon peels (food waste biomass), lavender straw (agro-waste biomass), and *Ludwigia hyssopifolia* (invasive species biomass) were selected

as substrates and different percentages of these substrates were used to prepare samples along with Ecovative's wet mixture. **Table 1** shows the corresponding cellulose and lignin content of these substrates and the composition of contents in each sample set. The substrate was first dried in the oven at 200°F for around 50-60 minutes if necessary (such as lemon peels) and then grinded to achieve a smaller and finer form. Sterilization was done by boiling the grinded substrate in tap water for at least 30-45 minutes. The water was then drained, and the substrate was dried in the oven at 200°F for around 40-60 minutes before inoculation.

**Table 1:** Cellulose-lignin ratio and percentages of components in samples

Sample ID	Component 1	Cellulose	Lignin	Percentage	Flour	Component 2	Cellulose	Lignin	Percentage
LP-20	Lemon Peel (Ververis et al., 2007)	12.72	1.73	20%	3%	Hemp Shives (Thomsen et al., 2006)	39	23.5	77%
LP-30				30%					67%
LP-40				40%					57%
J-20	Ludwigia Hyssopifolia (Premjet et al., 2013)	29.9	11.7	20%	3%	Hemp Shives	39	23.5	77%
J-30				30%					67%
J-40				40%					57%
LV-20	Lavender Straw (Wikee et al., 2017)	43	23	20%	3%	Hemp Shives	39	23.5	77%
LV-30				30%					67%
LV-40				40%					57%
NA	N/A	0	0	N/A	3%	Hemp Shives	39	23.5	97%

The specimens were grown in rectangular plastic containers with a base of 200x 300mm (8x12 inches). The tray, mixing containers, and hand gloves were first sanitized with isopropyl alcohol to prevent any contamination. GIY wet mix, flour, and substrates were mixed according to the percentages shown in Table 1 using a scale. After mixing all the elements properly and setting the mix in the tray, the grow trays were covered with plastic wrap with small holes 25 mm (1 inch) apart for controlled air intake. The samples were grown at room temperature without any direct sunlight for 4-6 days (**Figure 4**). When the samples turned completely white, they were carefully taken out of containers. To increase the strength and density of the samples, the samples were then compressed in a manual book press for 24 hours. After compression, to prevent the growth of mycelium and fruiting bodies, the samples were heated in the oven at 200°F for 60-80 minutes. Lastly, they were air-dried for another 48 hours to ensure uniform drying, the dried specimen usually weighs one-third of the wet one. It was found from sample preparation that proper sanitization and uniform drying prevented any mold growth in the process.



**Figure 4:** Top: specimen preparation, bottom: specimen growth day 0-5 (Ridwana, 2019)

### 2.3. Preliminary mechanical and hygrothermal characterization of mycelium- organic waste biocomposites

Mechanical characterization of the biocomposite specimens was based on flexural tests according to ASTM D-1037 standard. Specimens containing lemon peel wastes were selected as a use-case for hygrothermal characterization due to mechanical consistency and availability of the raw material. Thermal conductivity tests were performed according to the ASTM C-518 standard and the most effective ratio was selected for further preliminary hygric characterization. As specified in the ASTM E96/E96-M16 standard, water vapor transmission tests were performed in an enclosed and insulated environmental chamber.

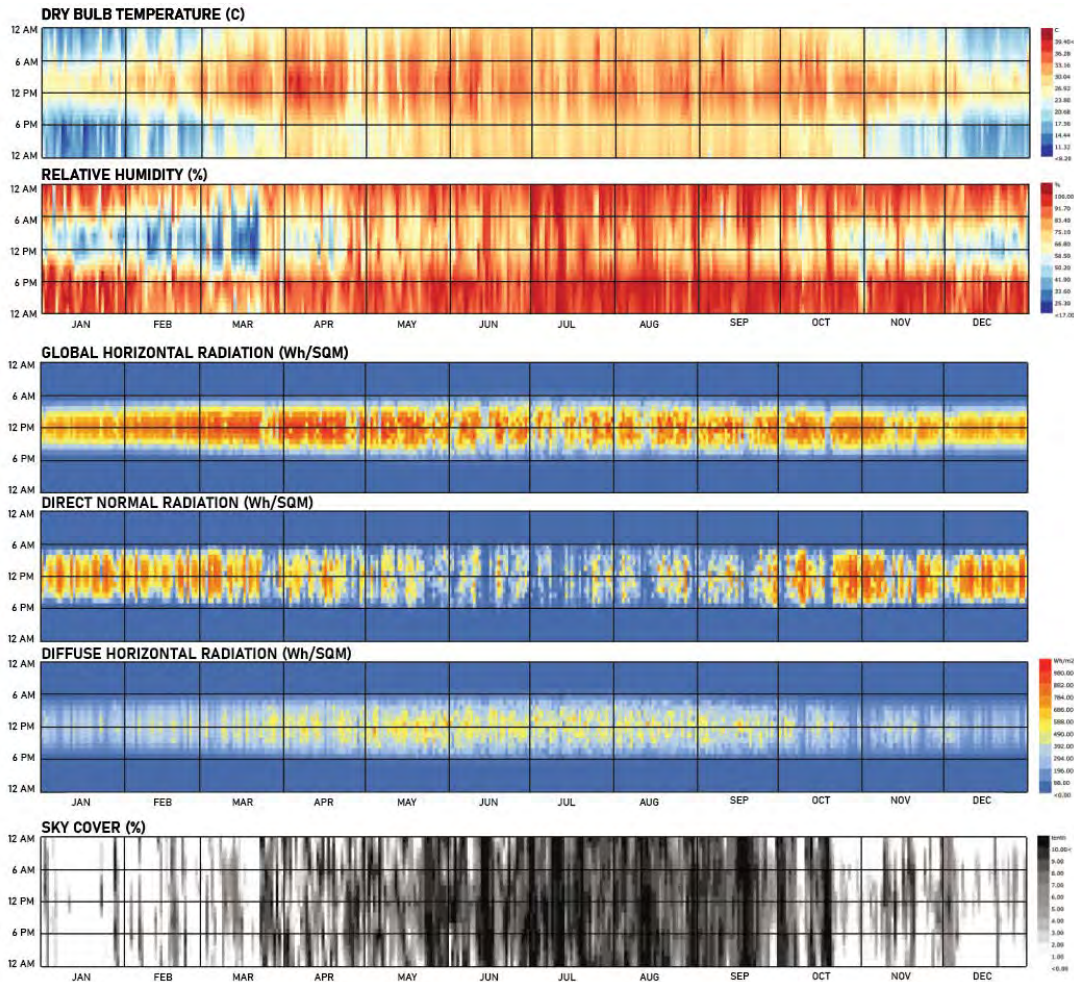
### 2.4. Context analysis for the integration of mycelium – organic waste bio-composites production in informal settlements

The production process of mycelium bio-composites in the context of an informal settlement in Dhaka is designed and integrated according to the existing conditions of the case study area, building morphology, and building materials in conjunction with the climate analysis and availability of raw materials according to local harvests.



### 2.4.1. Climate analysis of Dhaka

The climate analysis shows the available climatic energy resources in the context and these resources are the means of integrating the production system in the case study area. In design, the intention was to maximize the use of available solar, wind, and water resources in different infrastructures provided in each stage of production instead of relying on other energy sources.



**Figure 5:** (Top) Dry bulb temperature & relative humidity; (Middle) solar radiation data and (Bottom) sky cover for Dhaka, Bangladesh

Dhaka, Bangladesh usually experiences a tropical hot and humid climate with dry winter, characteristic of Aw Köppen Climates (Climate of the World: Bangladesh, 2019). **Figure 5** shows the variation in dry bulb temperature and relative humidity in three different seasons around the year. Dry bulb temperature is relatively high during the daytime which can be used for the production stages where heating or drying is necessary. High humidity is necessary for the growth stage but constraints direct exposure to air after growth as these composites may start to have molds due to too much moisture. A similar constraint is applicable during the rainy season. Observing the sun path, it was found that, southwest orientation is preferable to receive maximum radiation during the daytime. Sun exposure can be maximized on the building envelope during the Winter season due to the low sun angle. A simulation was also run with one and two-story height of the site clusters to maximize the radiation, as this is a dense area. It was observed that adding a vertical layer in the cluster increases the amount of radiation on the envelope from 2 to 3.6 kWh/m<sup>2</sup>. Exposure to radiation on the envelopes maximizes the heat gain which helps in the stages of production like sterilization and drying. Adding to that, the majority of the wind in this site flows from North and South around the year. However, North is the dominant orientation between these two.

### 2.4.2 Simulation of temperature and humidity in production area cluster

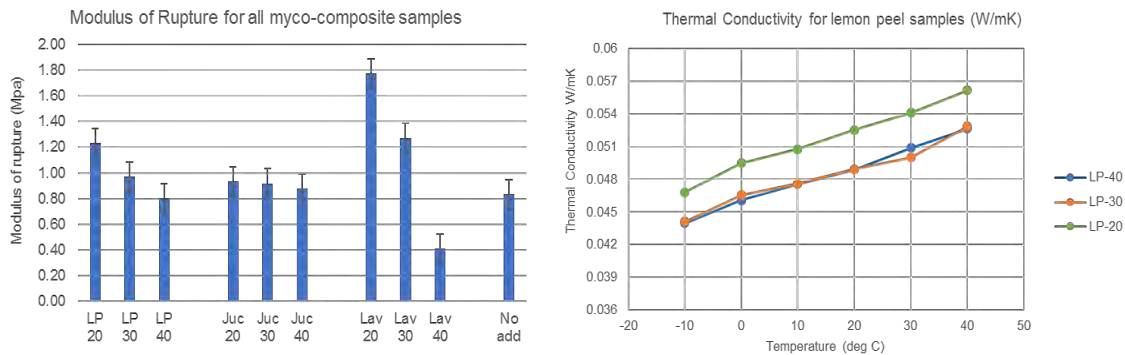
A cluster of 6 living units with a shared kitchen and two toilets was selected and the shared service zone was used for further design as this is the most active area used by all members. To understand the results of the design in terms of temperature and humidity as these two parameters are crucial for the stages of production, the proposed production

space was investigated using Energyplus (Version 8.7.0). The designed production space was specified with Euclid (Legacy Open Studio). There were four zones- ground floor, production space, grow chamber, and chimney. The walls were specified as metal surface, ground floor as concrete, intermediate floor as the bamboo floor, grow chamber made with bamboo, and chimney with the metal surface as well. The analysis period of July in Dhaka was chosen to investigate system performance during the highest humidity and temperature conditions.

### 3.0 RESULTS DISCUSSION AND ANALYSIS

#### 3.1 Mechanical and preliminary hygrothermal characterization of mycelium organic waste biocomposites

In general, the addition of 20-40% of chosen food, agro-waste, and invasive species biomass to mycelium substrate mixtures maintained or slightly improved the mechanical performance of myco-composite boards. An improvement in the modulus of rupture was observed for samples with 20% of biomass wastes, however, an additional increase in waste biomass composition led to a decrease in MOR (Figure 6). Myco-composites with agro-waste 20% demonstrated the highest MOR. Due to relatively consistent and improved mechanical performance results, lemon peel samples were further used to preliminary characterize how thermal conductivity changes with increasing food waste ratios. Lemon peel specimens containing 30% performed better than other percentages. The thermal conductivity of LP-30 was 0.05 W/mK which is similar to the conductivity of synthetic foam and wood-based materials.



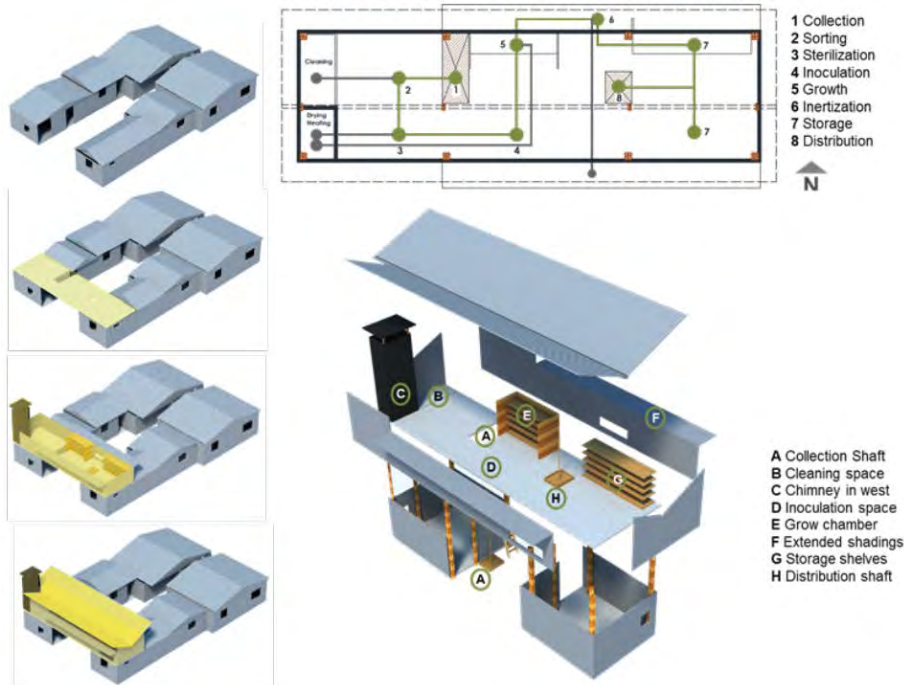
**Figure 6:** Results showing modulus of rupture (MPa) with an increasing percentage of organic waste (left) and thermal conductivity for lemon peel samples (right)

#### 3.2. Integrating the production of mycelium – organic waste biocomposites in informal settlements

To integrate the production cycle with occupancy patterns, the main production space was designed on the vertical extension of the service area, with circulation provided from courtyard space (A). This also maximizes the exposure of roof and wall surfaces to solar radiation and wind flow. As outlined in Figure 3, each stage of the production process was spatialized in the use as shown in Figure 7. Three kinds of waste containers are proposed and accessible to the household and community scale. A space is dedicated for the cleaning and sorting (B) of the waste with a manually operated lift. A solar chimney with corrugated metal sheets painted in black is proposed to dry the waste before and after sterilization (C) by boiling. This cleaning and drying stage prevents any contamination before inoculation. After Inoculation (D) with local mushroom spawns in preferred molds, they are grown in a grow chamber (E) made with closed bamboo shelves covered with plastic sheets to prevent direct sunlight. Plastic sheets help to maintain the high humidity levels inside the shelves for growth. Drying to prevent the growth of the mycelium is proposed at the chimney and extended shadings (F) after the growth stage is done. Products can be stored (G) and later distributed (H) to local markets by the inhabitants engaged in the production process. In this way, the whole production process was integrated yet separated from the living and service spaces and properly ventilated to avoid mold or contamination.

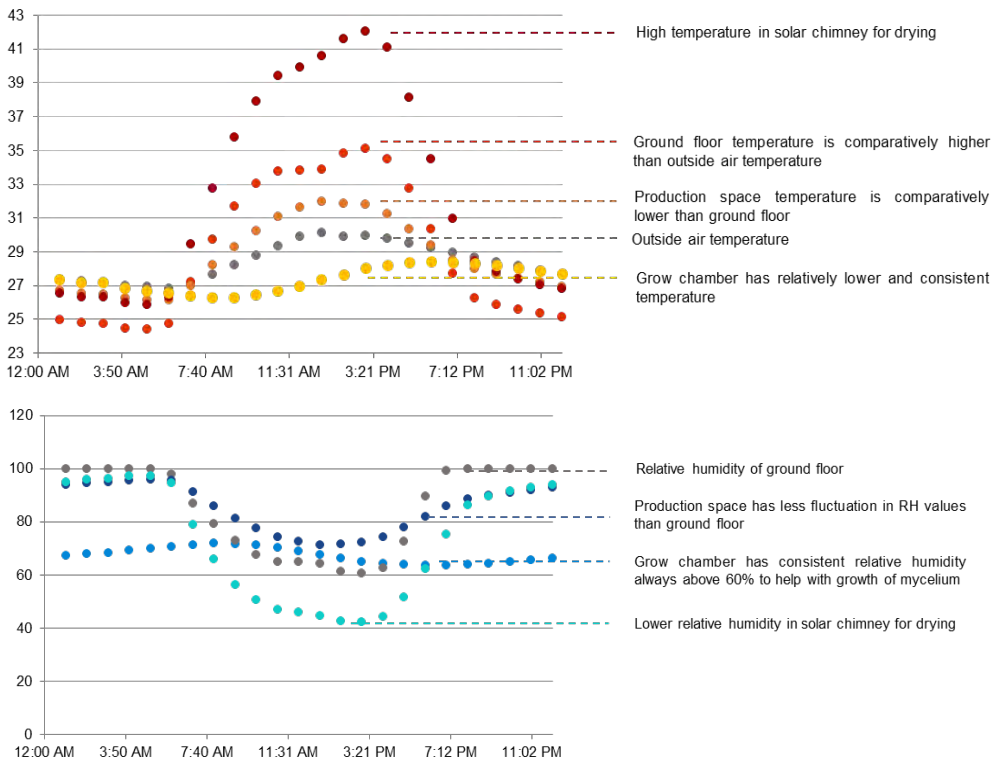
#### 3.3. Interior condition of the proposed spaces

The previously described test building was simulated with specified design components and material properties in EnergyPlus software. As shown in Figure 8, the air temperature inside the ground floor and production are higher than the outside air temperature, although production space is only 2°C above the outside air temperature. This happens due to the corrugated metal sheets on the walls. The chimney primarily designed for heating and drying had the highest temperature rise amongst all the zones, demonstrating a maximum temperature of 42°C due to late afternoon western exposure.



**Figure 7:** Parti diagram showing the addition of 2nd floor for integrated waste upcycling (Right), Plan at +4000 mm (Top left) and exploded isometric of the proposed production space and key components

Variations in relative humidity in different zones also relate to the trends of temperature with high diurnal fluctuations in chimneys and ground floor. July has the least diurnal swings for the dry-bulb temperature and has very high relative humidity during both day and night times, but due to the use of material, diurnal swing range is higher in the chimney, which can create stack effect and induce airflow in the chimney for drying of the biocomposites.



**Figure 8:** Air temperature (°C) (top) and relative humidity (bottom) variation in different zones



## CONCLUSION

Focusing on available resources and the microclimatic conditions within dense informal settlements can present an opportunity to minimize the gaps between potential raw materials and manufactured goods. This research provides a tailored response to the case study context by implementing a broader framework that is adaptable in terms of place, people, biomass resources, and time. The preliminary mechanical and hygrothermal performance of mycelium-organic waste biocomposites display the potential to develop these composites as a replacement of several synthetic foam materials and wood products. The results from the simulation study investigate the matching stages of myco-production to exterior microclimatic conditions and predicted indoor conditions. Additionally, this approach can leverage the spatialization of myco-production to serve as temporary wall envelopes and roof insulation systems, and aid in reducing thermal comfort loads inside the living units in the future. This integrated approach in this preliminary study aims to activate a design and testing methodology that matches the unique waste-to-resource economy to in-situ microclimatic conditions within informal settlements.

## REFERENCES

- 1 Agricultural Statistics Yearbook, (2017), DATABD. Retrieved from <https://databd.co/resources/agricultural-statistics-yearbook> Accessed on June 14, 2019
- 2 Attias, Noam, Ofer Danai, Nirit Ezov, Ezri Tarazi, and Yasha J. Grobman. "Developing novel applications of mycelium based biocomposite materials for design and architecture." *Proceedings of Building with Biobased Materials: Best practice and Performance Specification, 6th–7th September* (2017): 76-77.
- 3 Climate of the World: Bangladesh (2019), *WeatherOnline*. Retrieved from <https://www.weatheronline.co.uk/reports/climate/Bangladesh.htm> Accessed on June 20, 2019
- 4 Counihan, C. H., "An incremental intervention in Jakarta: An empowering infrastructural approach for upgrading informal settlement", Master's thesis, (2014). Retrieved from [https://scholarworks.umass.edu/masters\\_theses\\_2/500/](https://scholarworks.umass.edu/masters_theses_2/500/) Accessed on July 17, 2019.
- 5 Cradle-to-cradle design, *Wikipedia*, (n.d.). Retrieved from [https://en.wikipedia.org/w/index.php?title=Cradle to\\_cradle\\_design&oldid=845587156](https://en.wikipedia.org/w/index.php?title=Cradle_to_cradle_design&oldid=845587156) Accessed on June 27, 2019.
- 6 Dhaka Population, (2019, May 12), *World Population Review*. Retrieved from <http://worldpopulationreview.com/world-cities/dhaka-population/> Accessed on June 26, 2019.
- 7 Girometta, Carolina, Anna M. Picco, Rebecca M. Baiguera, Daniele Dondi, Stefano Babbini, Marco Cartabia, Mirko Pellegrini, and Elena Savino. "Physico-mechanical and thermodynamic properties of mycelium-based biocomposites: A Review." *Sustainability* 11, no. 1 (2019), 281. doi:10.3390/su11010281.
- 8 Kaza, Silpa, Lisa Yao, Perinaz Bhada-Tata, and Frank Van Woerden. *What a waste 2.0: a global snapshot of solid waste management to 2050*. The World Bank, 2018.
- 9 Mahabir, Ron, Andrew Crooks, Arie Croitoru, and Peggy Agouris. "The study of slums as social and physical constructs: challenges and emerging research opportunities." *Regional Studies, Regional Science* 3, no. 1 (2016), 399-419. doi:10.1080/21681376.2016.1229130.
- 10 Mohit, Mohammad A. "Bastee Settlements of Dhaka City, Bangladesh: A review of policy approaches and challenges ahead." *Procedia - Social and Behavioral Sciences* 36 (2012), 611-622. doi:10.1016/j.sbspro.2012.03.067.
- 11 Premjet, Siripong, Boondarick Pumira, and Duangporn Premjet. "Determining the potential of inedible weed biomass for bio-energy and ethanol production." *BioResources* 8, no. 1 (2012). doi:10.15376/biores.8.1.701-716.
- 12 Ridwana, Iffat. "design integration of mycelium biocomposites production using organic waste in informal settlements." MS Thesis., Rensselaer Polytechnic Institute, 2019.
- 13 Silverman, Jillian. "Development and testing of mycelium-based composite materials for shoe sole applications." PhD diss., University of Delaware, 2018.
- 14 Thomsen, Anne B., Anders Thygesen, Vibeke Bohn, Kristina V. Nielsen, Bodil Pallesen, and Michael S. Jørgensen. "Effects of chemical-physical pre-treatment processes on hemp fibres for reinforcement of composites and for textiles." *Industrial Crops and Products* 24, no. 2 (2006), 113-118. doi:10.1016/j.indcrop.2005.10.003.
- 15 UNDP, (2018, May 16), 68% of the world population projected to live in urban areas by 2050, United Nations. Retrieved from <https://www.un.org/development/desa/en/news/population/2018-revision-of-worldurbanization-prospects.html> Accessed on October 10, 2018.
- 16 UN Habitat III, (2016, October 17-20) *The Habitat III Issue Papers*. Retrieved from <http://habitat3.org/documents-and-archive/preparatory-documents/issue-papers/> Accessed on June 17, 2019
- 17 UN Habitat, (2014), Population density by city, *Our World in Data*. Retrieved from <https://ourworldindata.org/grapher/population-density-by-city> Accessed on June 26, 2019.
- 18 Ververis, C., K. Georghiou, D. Danielidis, D.G. Hatzinikolaou, P. Santas, R. Santas, and V. Corleti. "Cellulose, hemicelluloses, lignin and ash content of some organic materials and their suitability for use as paper pulp supplements." *Bioresource Technology* 98, no. 2 (2007), 296-301. doi:10.1016/j.biortech.2006.01.007.
- 19 Waste Concern, *Waste Database | Waste Concern*, (2014), Retrieved from <https://wasteconcern.org/waste-database/> Accessed June 17, 2019.
- 20 Wikee, Saowanee, P. Chumnunti, A. Al Kangaeh, Ekachai Chukeatirote, S. Lumyong, and Craig Faulds. "Lignocellulolytic capability of endophytic *Phyllosticta* sp." *Journal of Bacteriology and Mycology* 4, no. 2 (2017). doi:10.26420/jbacteriolmycol.2017.1047

# Adaptive Model Conditions for Thermal Comfort in Schools: Riverside, California | Lima, Peru | Nairobi, Kenya

David Mwale Ogoli<sup>1</sup>

<sup>1</sup>California Baptist University, Riverside, CA

**ABSTRACT:** This study examined adaptive model conditions for thermal comfort in School buildings by comparing them in three hot climates of Riverside, California, Lima in Peru and Nairobi, Kenya. It observed different thermal comfort conditions using the ASHRAE adaptive model. This model used the predictive mean vote / predicted percent of dissatisfaction (PMV/PPD) as developed by P.O. Fanger in the late 1960's and the Adaptive Model which has rapidly become widespread around the world. This article scrutinized which model is more suitable and energy efficient for the three locations. Three sample schools were modelled using building information modelling (BIM). Simulations were done using Computational Fluid Dynamics (CFD) to study air flow and thermal comfort. Measured data were gathered in the School building in California for comparison and validation. Indoor renderings were studied using Autodesk 3DS Max. The study suggested that when humans are considered as laboratory subjects, they tend to have a universally agreeable thermal comfort range about 65°F – 78°F (18.3°C-25.6°C) but when they are given more control of their living or work space, the comfort range widens. It is possible that the economic, cultural and technological expectations of people may be factors that account for the extension of the thermal comfort zone. When the comfort zone was extended, the energy-efficiency in buildings was enhanced. The study further suggested that forcing a building onto a site that would constantly reject it as being unsustainable would increase demand of energy for occupants in the climate. Different comfort models have a different effect on the number of hours that fall within the comfort zone. When people are able to adjust their surroundings for adaption, they tend to be comfortable at wider ranges. Many developing countries lack significant research studies, and this is a request to consider more similar in-depth studies internationally.

**KEYWORDS:** Climate, Energy, Thermal Comfort, Psychrometrics

## 1.0 INTRODUCTION

Many literary sources reviewed dating from the first century with Vitruvius, and then skipping a huge gap up to the 1960's indicate that humans have always attempted to reconcile the vagaries of local climate to thermal comfort for occupants of buildings. The body of knowledge in research in this study started in the 1960's and continued up to the present date. Many studies on thermal comfort include the works of Fanger, Olgay, ASHRAE, deDear, Nicol, Humphreys, Nishi, Rohles, and Szokolay, among many others. These published works have observations and recommendations on some of the ways to achieve the best design approach for different regional locations. Studies appear to suggest that the thermal sensation of people living in countries with similar climatic, social, and economic conditions can achieve optimum thermal comfort by adapting to a wide range of temperature fluctuations when they have an adaptive model in the built environment.

It was reported during the 2007 ARCC Spring Research Conference held in Eugene, Oregon that "The adaptive model is the most effective way of assessing passive solar buildings, or what is sometimes called *free-running buildings*. The adaptive models allow people to make adjustments to their clothing, activity, posture, eating or drinking, shifting position in a room, operating a window or shading device, or other adaptive opportunity in order to achieve or maintain thermal comfort. It appears that when people are allowed greater adjustment and control over their own indoor environment, it extends the comfort zone. The adaptive model acknowledges that the occupant is not just a passive recipient of the environment but an active member." (Ogoli, 2007:21). This leads to the concept of operative temperature that defines a uniform temperature of an imaginary black body enclosure in which an occupant would transfer equivalent amount of heat by radiation as nonuniform regular environment. As such, operative temperature has the combined effects of mean radiant temperature and ambient dry-bulb air temperature. It is plotted on the psychrometric chart produced by the *ASHRAE Standard 55-2017* (Figure 1). In simple terms, operative temperature ( $t_o$ ) can also be expressed in terms of dry-bulb temperature ( $T_{db}$ ) and mean radiant temperature ( $T_{mrt}$ ) as:

$$T_o = \frac{T_{db} + T_{mrt}}{2}$$

Equation 1

Consequently, and as an example, ASHRAE *Standard 55-2017* suggests a clo-value of 1.0 for winter and 0.5 for the summer for people living in the US. And so on.

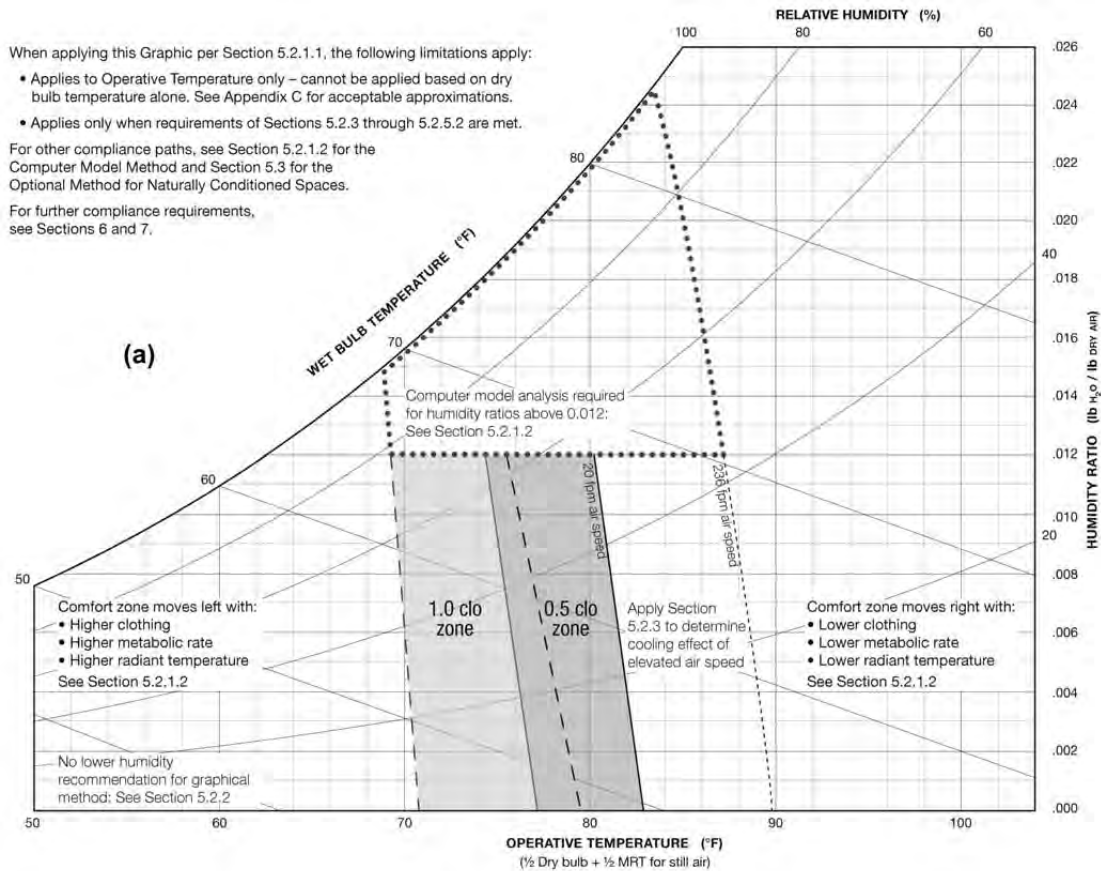


Figure 1: ASHRAE Psychrometric Chart  
Source: ASHRAE *Standard 55-2017*

## 2.0 OBSERVATIONS

### 2.1. Experimental Set-up

This study used the sample of an existing Architecture building on the campus of California Baptist University in Riverside, CA. A similar building was replicated in computer simulations for Lima Peru and Nairobi, Kenya. The building had two levels of tuition and office spaces and it measured about 168 feet (51.2 m) by 108 feet (32.9 m) with a floor-to-floor height of 15 feet (m). The building was monitored by HOBO U30 weather station (Figure 2) configured to use up to 15 channels to collect indoor and outdoor environmental data.

Four studio areas in the building were selected as sample spaces where students gathered for most of their time, ranging from first year studio to fourth year studio. Temperature/Relative humidity smart sensors (HOBO S-THB-M008) had extension cables that were strategically placed in the four studios. The measurement range of these sensors was  $-40^{\circ}\text{F}$  to  $167^{\circ}\text{F}$  ( $-40^{\circ}\text{C}$  to  $75^{\circ}\text{C}$ ). The accuracy of the sensors was  $\pm 0.38^{\circ}\text{F}$  from  $32^{\circ}$  to  $122^{\circ}\text{F}$  ( $\pm 0.02^{\circ}\text{C}$  from  $0^{\circ}$  to  $50^{\circ}\text{C}$ ). Wind Speed Smart Sensor S-WSB-M003 with 10-foot (about 3m) cable and Wind Direction S-WDA-M003 Smart Sensor with 10-foot (about 3m) cable were also installed in the spaces. Data were upload to HOBOWare software for analysis.



Figure 2: HOBO U30 weather station

## 2.2. Climate of Riverside, CA, Lima, Peru and Nairobi, Kenya

The average high temperatures and average low temperatures for the three cities of Riverside CA, Lima, Peru and Nairobi, Kenya are shown in Tables 1-4. These three locations were selected because they have similar conditions typical of highland tropical regions. Riverside CA has the hottest month in August with an average high temperature of 95.4°F (35.2°C), with five comfortable months with high temperatures in the range of 70-85° (21.1 – 29.4°C), brief cool winters, little rain and dry conditions all year round. In Lima, Peru, the climate is sub-tropical desert, with warm conditions (summer) from December to April and a cool, humid and cloudy (winter) season from June to October. May and November are transitional months. In Kenya, lowland areas are hot and with low rainfall. The coastal strip and the areas near Lake Victoria are hot with high humidity. Table 4 shows the severity of extreme annual seasons by using the annual degree days. Nairobi is most mild.

Table 1: Riverside, CA Latitude 33.88°N and longitude 117°W

	Jan	Feb	Mar	Apr	May	Jun	Jul	Aug	Sep	Oct	Nov	Dec
High (°F)	68	68	71	76	80	87	94	95	91	83	74	67
Low (°F)	43	44	46	49	54	57	62	62	59	53	46	42

Table 2: Lima Peru is on latitude 12°S and longitude 77°W

	Jan	Feb	Mar	Apr	May	Jun	Jul	Aug	Sep	Oct	Nov	Dec
High (°F)	79	81	80	76	72	68	66	66	67	69	71	75
Low (°F)	68	69	68	65	63	61	60	59	59	61	63	65

Table 3: Nairobi Kenya is on latitude 1.3°S and 36.8°E.

	Jan	Feb	Mar	Apr	May	Jun	Jul	Aug	Sep	Oct	Nov	Dec
High (°F)	79	81	80	77	75	73	72	73	77	79	76	76
Low (°F)	59	59	61	61	59	56	54	55	56	59	60	59

Table 4: Heating and Cooling degree days

	Riverside, CA	Lima, Peru	Nairobi, Kenya
Heating Degree days (base 65)	2349	327	152
Cooling Degree days (base 65)	709	1402	1062

## 2.3. Building Model

The building used in the study is shown in Figure 3. It is a long building on two levels at the intersection of Adams street and magnolia Avenue in the City of Riverside, CA. It has tiles walls and large glazed areas.



Figure 3: The School building model – used for measured and simulation data

### 3.0 ANALYSIS AND DISCUSSION

Measured data were observed and computer modeling done using computational fluid dynamics simulation and solid body motion analysis software mainly by *Autodesk CFD Ultimate 2021*. Observations for natural ventilations were set in nine different permutations for the locations of operable windows, namely, at low-level, middle-level and high level. Air velocity was simulated at 2 m/s (approximately 400 fpm) typical to prevailing wind patterns in the three cities. A human mannequin was included whose objective was to evaluate the effectiveness of the ventilation system for two different modes: summer (warm season) and winter (cool season). The thermostat was set to deliver cool air (64 °F) in the summer and warm air (85 °F) in the winter. The study created and ran a two-scenario simulation by using the same geometry for the two scenarios in the three locations using *Autodesk CFD*. Unique outdoor air and HVAC supply air temperatures were assigned for each case. The goal of this part of the study was:

1. Evaluate the flow and temperature distributions for summer (warm) and winter (cool) periods.
2. Assess whether the occupant thermal comfort level is within acceptable limits (thermal sensation).
3. Understand the reasons for occupant comfort levels and determine the ventilation strategy needed.

The ASHRAE Predicted Mean Vote (PMV) seven-point scale was used as a measure of thermal comfort.

#### 3.1. Ventilation Analysis

Air was introduced into a test room at low level being 1m (3 feet), mid-level being 2m (6 feet) and high-level being 3m (9 feet) on the windward side of the building. Exhaust air was allowed to exit at similar levels of 1m (3 feet), 2m (6 feet) and 3m (9 feet) on the leeward side of the building. An exterior volume was created to simulate outdoor air that would impact the building. Figure 4 summarizes the results for one scenario.

#### Parametric Ventilation Analysis

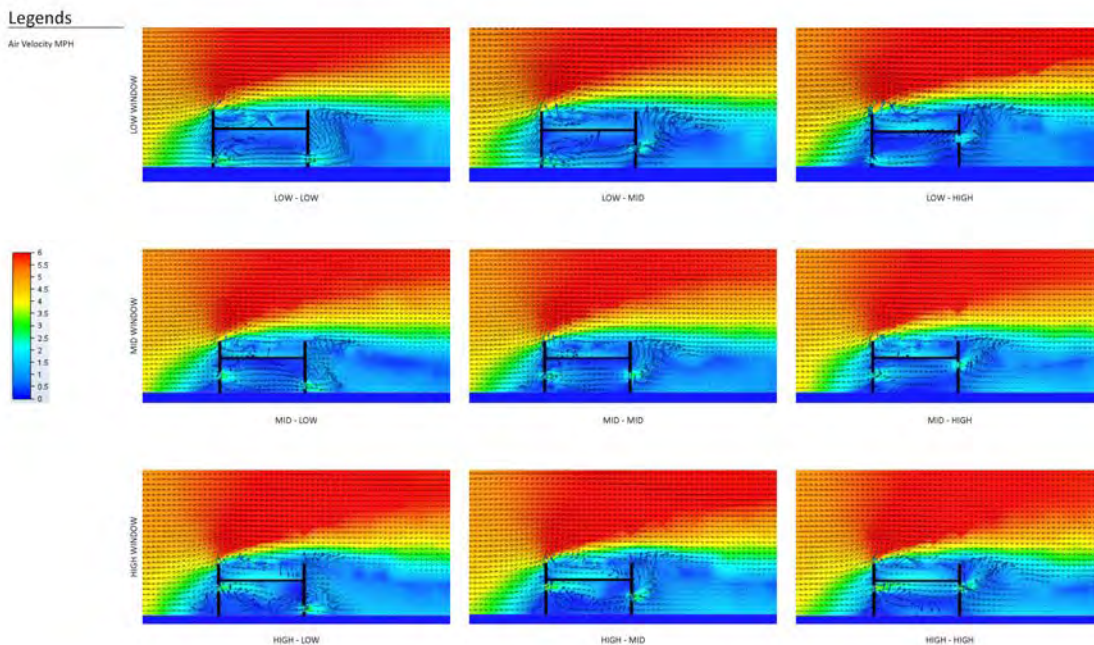


Figure 4: Parametric Ventilation Analysis in Lima, Peru  
Computer Simulation performed by Luis B. Illanos

These illustrations show that a low inlet and low outlet had little impact on air convection within the room. The air came and left almost on a straight line before adequately interacting with the ambient room air. This could probably introduce problems that would insufficiently ensure good indoor air quality. Progressively raising the outlet to middle level and high level solved the problem more effectively. Raising the inlet to the middle level and keeping a low outlet ensured good air convection in the room. This improved when inlets stayed at that level while simultaneously raising the outlets to the middle and high level. These observations (Figure 4) appear to suggest that the least effective ventilation strategy is high-level inlets and low level outlets because they did not ensure good convection. A middle level inlet and middle level or high-level outlets were the most effective. It is supported by thermal sensation parametric study measured by PMV and illustrated in Figure 5.



### 3.2. Thermal Comfort Analysis

#### Parametric Thermal Comfort Analysis - Summer

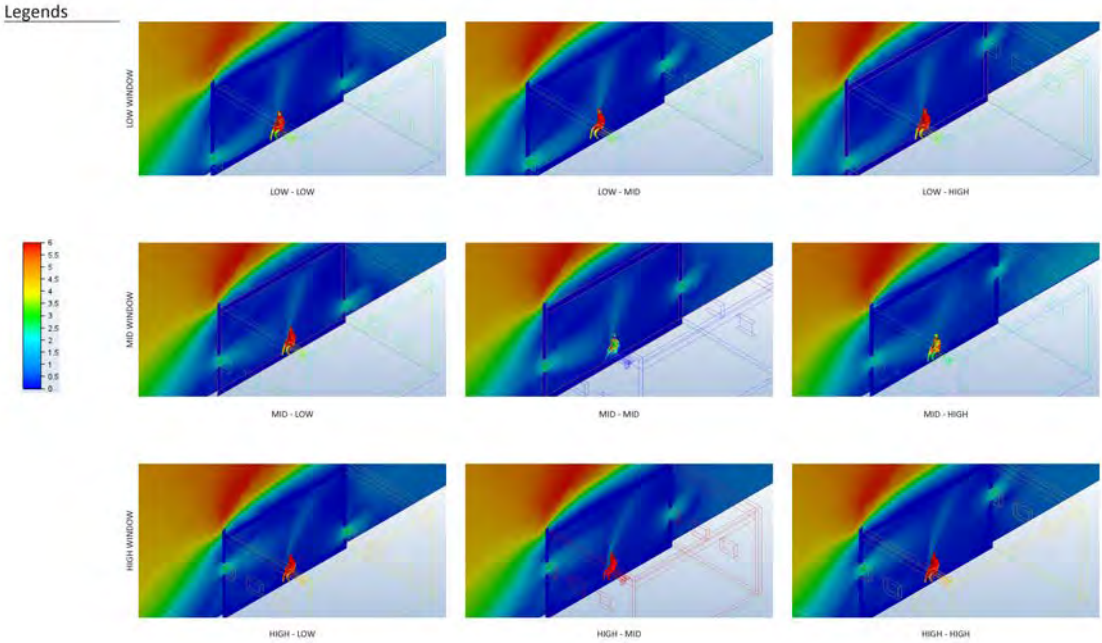


Figure 5: Parametric Thermal Comfort Analysis (Summer - December) in Lima, Peru  
Computer Simulation performed by Luis B. Illanos

#### Parametric Thermal Comfort Analysis - Winter

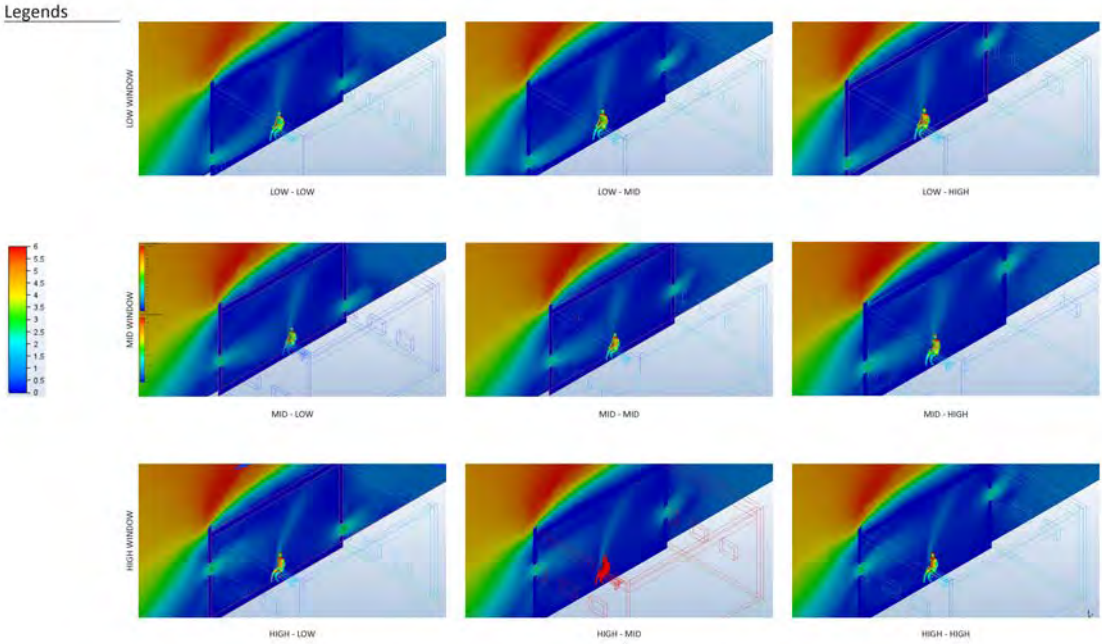


Figure 6: Parametric Thermal Comfort Analysis (Winter - July) in Lima, Peru  
Computer Simulation performed by Luis B. Illanos



### 3.3. Adaptive Factors in Thermal Comfort

The California Code comfort model is defined by the dry bulb temperatures at 68°F (20°C) for heating to 75°F (23.9°C) for cooling. The Code is a static model that assumes that the indoor dry-bulb temperature ranges required for thermal comfort do not change. A second comfort model defined in *ASHRAE Standard 55* is known as the PMV (Predicted Mean Vote)/PPD (Percent People Dissatisfied) model. It was derived mainly in laboratory experiments with algorithms that consider dry bulb temperature, humidity, air velocity and metabolic activity. For US applications, it has a summer comfort zone and winter comfort zone with slightly sloped temperature limits. In this study, assumption was made that the mean radiant temperature (MRT) was equal to dry bulb temperature. The third adaptive comfort model has been modified in *ASHRAE Standard 55-2017* as it applies to free-running naturally ventilated spaces where people have the ability to change posture, position, open and/or close windows. Under these conditions, about 80% of the population are acceptable when average outdoor air temperatures are between 50° F (10°C) and 92° F (33.3°C). This model was used in this study to show that students in an academic building have a wider comfort range than in buildings with centralized HVAC systems. During the time of the study, the HVAC provided ventilation air only without conditioning. Students had clothing within 1.0 to .5 Clo values in moderate activity (1.0 to 1.5 Met).

CBU Architecture Building had two levels comprising of about 36,000 SF (3345m<sup>2</sup>) academic space. It had central VAV, HW Heat, Chiller 5.96 COP and boilers at 84.5% efficiency. The building had classrooms, offices and other support spaces. The main occupants of the building were students. Measured and simulated data were observed. Thermal sensation questionnaire consisting of the ASHRAE seven-point comfort scale was conducted with 35 student subjects in the Building starting at 1:00 PM during their normal studio sessions on October 28, 2019. Four extra questions were asked to assess thermal preference, humidity conditions and air flow conditions. Observations are shown in Tables 5-8. PMV seems to indicate that most people find a standard naturally ventilated school building to be thermally comfortable (neutral).

Table 5: PMV Thermal Sensation (Temperature)

QUESTION	SCALE	THERMAL SENSATION	VOTE	%
How do you feel about the thermal environment in this room?	3	Hot	1	2.90%
	2	Warm	2	5.70%
	1	Slightly Warm	4	11.40%
	0	Neutral	8	22.90%
	-1	Slightly Cool	6	17.10%
	-2	Cool	10	28.60%
	-3	Cold	4	11.40%

Table 6: Thermal Preference

QUESTION	RESPONSE	VOTE	PERCENTAGE
I would like to be ...	Cooler	18	51.4
	No Change	13	37.10%
	Warmer	4	11.40%

Table 7: Thermal Sensation (Humidity)

QUESTION	SCALE	THERMAL SENSATION	VOTE	%
How do you feel about the humidity in this room?	3	Much too dry	2	5.70%
	2	Too dry	0	0.00
	1	Slightly dry	11	31.40%
	0	Neutral	22	62.90%
	-1	Slightly humid	0	0.00%
	-2	Too humid	0	0.00%
	-3	Much too humid	0	0.00%

Table 8: Thermal Sensation (air movement)

QUESTION	SCALE	THERMAL SENSATION	VOTE	%
How do you feel about the air movement in this room?	3	Much too still	0	0.00
	2	Too still	6	17.10%
	1	Slightly still	8	22.90%
	0	Neutral	14	40%
	-1	Slightly breezy	4	11.40%
	-2	Too breezy	3	8.60%
	-3	Much too breezy	0	0.00%

Observation of the measured and simulated data showed that students were within the Psychrometric Chart comfort zone as defined by dry bulb temperature and humidity. The primary difference between the three comfort models, namely California Energy Code, *ASHRAE Standard-55* PMV/PPD, and Adaptive model was the length of comfort hours.

The adaptive model had the longest. Duration of the test period was three of hours of studio work when the students in the occupied spaces were assessed for thermal comfort conditions. Different comfort models have a different effect on the number of hours that fall within the comfort zone. Data in the building began in September 2019 to date. Figure 7 shows a sample of the corresponding measured dry-bulb temperature, wet-bulb temperature and wind data for the building.

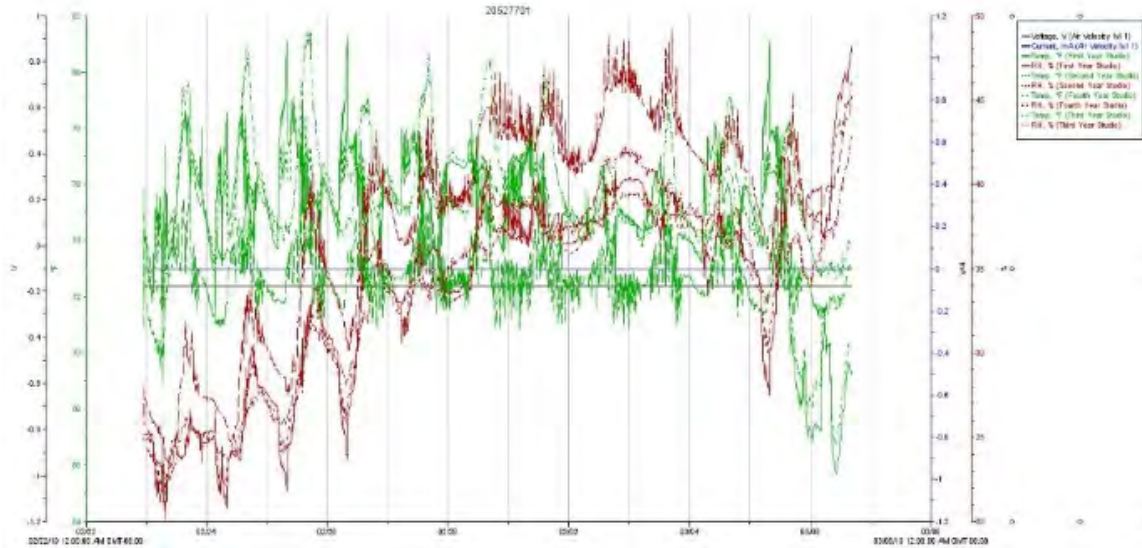


Figure 7: Measured temperature, humidity and wind data Measured using HOBO U30 weather station and sensors and graphically represented by HOBO software.

The ASHRAE PMV/PPD model associates a relationship between the human body temperature and the ambient temperature in order to achieve comfort with defined activity levels of the test subjects (ASHRAE, 2017). The heat flow needed to achieve optimum comfort based on activity is given as follows:

$$PMV = 0.303^{-0.036M+0.028}L \quad \text{Equation 2}$$

Where:

M = Metabolic Rate, and can be obtained from *ASHRAE Standard 55*

L = Thermal Load, which is defined as the difference between an individual's internal heat production and the individual's heat loss to the environment (Fanger, 1970). Predictive Mean Vote (PMV) with specific activity falls between -0.5 and 0.5. PMV leads to the determination of Predictive Percent Dissatisfied (PD) estimated as follows:

$$PPD = 100 - 95^{-\left(0.03353PMV^4 + 0.2179PMV^2\right)} \quad \text{Equation 3}$$

According to *ASHRAE Standard 55 – 2017*, anyone not voting -1, 0, or 1 is defined as being dissatisfied. PPD of 10% corresponds to a PMV range of  $\pm 0.5$ , and even with a  $PMV = 0$  the percentage of people dissatisfied would be 5%. Observations made in the building showed that the actual Predicted Mean Vote (APMV) and the actual Predicted Percentage of Dissatisfied (APPD) ratio of APMV/APMV had these results:

$$PMV = 0.303^{-0.036M+0.028}L \quad \text{Equation 4}$$

Results in this experiment were  $APMV = -1.35$ . Applying this value in the APPD formula:

$$PPD = 100 - 95 \exp^{-\left(0.03353PMV^4 + 0.2179PMV^2\right)} \quad \text{Equation 5}$$

Using the APMV value yields the result of  $PPD = 42.87\%$ .

Based on the *ASHRAE Standard 55* PMV/PPD model, the percentage of occupants thermally dissatisfied with the indoor environment in the CAVAD Architecture building is 42%. This is a large number of test subjects voting that the environment was not comfortable. Discomfort in the environment may have been due to the cooler than normal temperature in the environment.

#### 4.0 OBSERVATIONS FROM OTHER STUDIES

People are comfortable in a wide range of conditions found globally. They are probably affected by socio-economic and cultural expectations. *ASHRAE Handbook of Fundamentals* (2017) noted that:

“the conscious mind appears to reach conclusions about thermal comfort and discomfort from direct temperature and moisture sensations from the skin, deep body temperatures, and the efforts necessary to regulate body temperatures). In general, comfort occurs when body temperatures are held within narrow ranges, skin moisture is low, and the physiological effort of regulation is minimized. Comfort also depends on behaviors that are initiated consciously or unconsciously and guided by thermal and moisture sensations to reduce discomfort. Some examples are altering clothing, altering activity, changing posture or location, changing the thermostat setting, opening a window, complaining, or leaving the space.”

Adaptive thermal comfort models are an observation of constantly changing conditions under which people live and work in buildings. When people are able to adjust their surroundings for adaption, they tend to be comfortable at wider ranges. It was been observed that the adaptive activities can increase the perception of comfort to a range of air temperatures from about 63°F (20°C) to 88°F (31.1°C) (Humphreys and Nicol 1998). They showed that the adaptive model when applied to a wide range of buildings, climates, and cultures is:

$$t_c = 75.6 + 0.43(t_{out} - 71.6) \exp -\left(\frac{t_{out} - 71.6}{61.1}\right) \quad \text{Equation 6}$$

Where:

$t_c$  = comfort temperature, and  $t_{out}$  = monthly mean outdoor temperature

Adaptive models can help to make architectural design and energy-efficiency decisions. Such decisions must integrate thermal comfort, lighting and energy efficiency. A study (Chen & Yang, 2015) observed that “Indoor thermal comfort and daylight access are two major concerns of building occupants, as they spend about 80% to 90% of the time on indoor activities”. Added to this study is the fact that natural ventilation is an effective sustainable design strategy that can promote indoor air quality, thermal comfort, lighting comfort and energy efficiency as observed by many researchers. More research questions were noted during the CAVAD Architecture study that need further research.

## 5.0 CONCLUSION

Observation of the measured and simulated data showed that students were within the Psychrometric Chart comfort zone as defined by dry bulb temperature and humidity. The primary difference between the three comfort models, namely California Energy Code, ASHRAE Standard-55 PMV/PPD, and Adaptive model was the length of comfort hours. The adaptive model was the longest. Different comfort models have a different effect on the number of hours that fall within the comfort zone. When people are able to adjust their surroundings for adaption, they tend to be comfortable at wider ranges.

## ACKNOWLEDGEMENTS

The study was made possible by a research grant support of HMC Designing Futures Foundation (DFF), 3546 Concours, Ontario, CA 91764 (909) 989-9979 without whose help this study would not have been done. Special thanks to Luis B. Llanos for assistance with simulations for Lima Peru. The contribution of the students, faculty and staff of CBU College of Architecture, Visual Arts and Design is hereby gratefully acknowledged.

## REFERENCES

- ASHRAE, *ANSI/ASHRAE Standard 55-2017: Thermal Environmental Conditions for Human Occupancy*. Atlanta GA: American Society of Heating, Refrigerating and Air-conditioning Engineers.
- Chen, KongXi; Yang, Hongxing. 2015. “Combined thermal and daylight analysis of a typical public rental housing development to fulfil green building guidance in Hong Kong” in *Energy and Buildings*, 2015:420-432. New York: Elsevier Science.
- De Dear, R.J. & G.S. Brager. 1998. “Developing an adaptive model of thermal comfort and preference” in *ASHRAE Transactions 104 (1)*. Atlanta GA: American Society of Heating, Refrigerating and Air-conditioning Engineers.
- Fanger, P.O. 1972. *Thermal comfort: Analysis and Applications in Environmental Engineering*. New York: McGraw-Hill.
- Humphreys, M., and J.F. Nicol. 1998. Understanding the adaptive approach to thermal comfort. *ASHRAE Technical Data Bulletin 14(1):1-14*. Atlanta GA: ASHRAE.
- Ogoli, David Mwale 2007. *Thermal Comfort in a Naturally Ventilated Educational Building* in ARCC Journal of Architectural Research Volume 4 Issue 2. Published by the Architectural Research Centers Consortium | ISSN 2329-9339. And <https://arcc-journal.org/index.php/arccjournal/article/view/44/43> (last accessed Jan 18, 2021).

# Automated Energy Use Data Collection and Visualization for Game-based Education

Philip Reim<sup>1</sup>, Dr. Yang Song<sup>2</sup>, Dr. Malini Srivastava<sup>3</sup>

<sup>1</sup>North Dakota State University, Fargo, ND

<sup>2</sup>Texas A&M University, College Station, TX

<sup>3</sup>University of Minnesota, Minneapolis, MN

**ABSTRACT:** Live visualizations of building occupants' energy use produce heightened energy consciousness among occupants and result in actions taken to reduce consumption. In particular, smart energy monitor technology implemented in K-12 schools not only directs students' attention to the energy implications of their decisions at school, but also encourages the same degree of energy awareness at home. This paper documents a successful process and method for implementing smart energy monitor-based frequent comparative visualizations in seven public school buildings in a serious pervasive games-based educational and engagement effort intended to reduce school building energy use. The authors, who lead the work of this partnership, worked with public school district administrators, device manufacturers, and utility companies to effectively structure and install functioning live energy displays in the schools. For effective use of the functioning live energy displays, the method builds on a pervasive serious energy game designed, implemented and tested by the authors in classrooms with consistent success in achieving energy savings and learning gain amongst students. The paper describes the partnerships, roles, processes and methods needed to identify appropriate technology and evaluate the costs and returns on investments for the parties involved. This paper further describes the workflow developed by the authors for collecting, normalizing, and displaying collected data in an age-appropriate (for elementary, middle and high schools) comparative visualization. As the testing of the hardware and software commences, the COVID-19 pandemic-related school closures have created an opportunity to test a version of the educational game component that is fully asynchronous and more widely accessible beyond the school building. The installation of the hardware and the successful research and creation of a real-time visualization process provides the potential for testing the impact of energy use in schools and transfer of knowledge from the school environment to the home environment.

**KEYWORDS:** Energy, Monitoring, Visualization, Schools, Education

## INTRODUCTION

Smart energy monitors help to improve consumption awareness by providing building occupants with real time information on their energy use, and encourage actions taken to reduce energy waste (Faruqui et al. 2010). Smart monitors make energy use more transparent by displaying consumption in real time: a homeowner using a smart monitor can see which activities or appliances are causing the most dramatic increases in usage. On average, consumers using smart monitors have been found to reduce their consumption by around 7% (Faruqui et al. 2010). This occurs in homes as well as in K-12 school buildings, where students can learn energy saving habits that they will apply at home (Christensen & Knezek 2018; Fell & Chiu 2014). Despite the documented benefits of smart monitoring, the [Name of City] Public Schools district (PSD) had previously installed a monitoring device in only one of their twenty-one school buildings, with little or no student-focused complementary programming, activities, or curricula to develop educational opportunities based on this investment.

In previous years, the authors had designed and implemented pervasive serious energy games in PSD classrooms that paired energy use feedback (collected manually by the game research and design team) with game actions to reduce energy consumption. These game implementations, four times in three years, have resulted in energy use reductions in the participating schools. Based on existing literature documenting the positive energy-saving effects of smart monitors, the authors predicted that using smart energy monitoring for automated energy data collection and comparative visualization would further expedite and improve the results of serious game-based conservation education.

This paper documents a method of implementing smart monitors in municipal school buildings as a step toward reducing consumption through game-based education. The authors established a partnership among the school district, local utilities, and device manufacturers to complete installation and bring the equipment online. Additionally, they developed automated protocols for collecting and disseminating energy data to maximize the smart monitors' usefulness in energy games or standalone feedback applications.

## 1.0 BACKGROUND

Educational settings in K-12 school buildings are promising venues for monitor-based behavior interventions. Existing programs elsewhere have already integrated monitoring technology into school curricula, taking advantage of educational settings to improve impacts and learning outcomes (*eGauge + renew our schools*).

Previously, the authors approached energy use behavior modification through a pervasive serious energy game in PSD classrooms. Serious games, generally defined as non-entertainment educational games, have rapidly proliferated in the last 20 years as a means of educating players on energy issues and motivating behavior change (Srivastava 2019). Pervasive serious games include both real-world and constructed gaming aspects: game actions taken in real life result in real-life benefits while also advancing the player's standing in the game (Montola et al 2009; Coelho et al 2020). Pervasive serious energy games have been designed at varying scales since the 1970s, from supra-city to single building-scale (Srivastava 2019).

In the pervasive serious game implemented by the authors, K-12 students practiced energy saving actions and habits which reduced energy use in their buildings while also earning them game points in competition with other classrooms. Most actions were simple, such as powering off unused computers or using light meters to identify unnecessary electric lighting. Teachers helped students track their completed actions, which earned points for their classrooms (Srivastava 2019). The ultimate goal of this intervention was the formation of conservation attitudes and habitual behaviors, most clearly manifested in overall reductions of building energy use.

To motivate students' energy conservation and mark success in use reduction, the authors routinely collected electric and gas figures from school buildings' utility meters. They organized this data in easy-to-read graphic visualizations, which were then distributed back to participating classrooms on a weekly basis. These energy updates allowed students to see the success of their conservation efforts compared to those undertaken by other classrooms, thereby facilitating competition and encouraging those falling behind to take further measures (Srivastava 2019).

## 2.0. MOTIVATION

### 2.1. Benefits of improved energy visibility

Visibility of energy use is central to improved energy conservation in any setting. Electricity consumption is normally an "opaque" process: building occupants see their energy use as a lump sum in the monthly bill without any real idea of where most of it is being used (Faruqui et al., 2010). Most students have never even seen their schools' energy bills, resulting in even less awareness of their actual consumption. Smart monitors that make energy use data visible and understandable have the potential to spark discussion of energy use, waste and conservation in schools. A push for interventions in which live energy visualizations impact students' behaviors is also supported by a 2011 survey of student energy literacy, which recommends that effective energy education target students' attitudes and beliefs in addition to their knowledge of facts and abstract concepts (DeWaters & Powers).

### 2.2. Advantages for future energy games

Previously, the authors were required to visit every participating school in person to manually collect energy consumption data to let students see the impacts of their energy-saving actions. This required coordination with school facilities and maintenance staff (Facilities) who were sometimes unavailable; incurred a significant time cost, including travel between schools; inhibited geographic expansion of the pervasive game; and included a significant potential for human error (Srivastava, 2019; Abdelhamid et al., 2020).

The authors also encountered problems with correctly using the data itself, once collected. Multiple school buildings were supplied by different utility companies, who used different metering devices with unique display properties. This required coordination with each utility to ensure accurate reading. Recording consumption in a recognizable format such as kilowatt-hours often required the use of mathematical conversion factors shared by the utility companies, which could differ between companies and even between different meters used by a single company. The risk of human error remained, especially when performing complex conversion procedures on raw data from utility meters.

The features of commercial smart monitors presented a solution to some of the most significant difficulties that the authors identified. Most smart monitors connect directly to circuit boxes or electric supply lines, ensuring minutely accurate recording of electric current. Many are designed for easy installation and lay accessibility, presenting data in familiar units without requiring mathematical conversion. Because many such devices communicate to users remotely via internet connection, the authors' dependence on Facilities personnel would be greatly reduced. Data could be disseminated to students participating in pervasive games at any convenient time interval instead of weekly, as previously. The remote data access afforded by wireless connections would also allow scaling of pervasive games beyond the immediate location or school district.

## 3.0. ANTICIPATED CHALLENGES

Several potential obstacles to a smart monitor implementation were also evident before beginning the project. First, the

installation of monitoring devices on school utility lines would require the school district's permission, and therefore a level of coordination with PSD administrators. Even after receiving approval, the project would still require ongoing support from school staff, possibly including device maintenance long into the future. Depending on Facilities' level of familiarity or technical ability with the selected technology, additional assistance with installation and maintenance could be required from individuals or companies outside the school district.

With the devices installed, ongoing continuous visibility of transmitted energy data would be imperative. If live visualizations were available to students for only a short time after installation, impacts on energy behaviors and usefulness to energy games would be limited. During both installation and operation, the equipment's technical details and specific functional requirements would require close partnership between the authors, schools, utilities, and manufacturer with a minimal acceptable margin for miscommunication.

## 4.0. APPROACH

### 4.1. Hardware installation

The authors secured a State Energy Program (SEP) grant from the [Name of State] Department of Commerce to fund the purchase and installation of school energy monitors. The grant had a stated focus on energy education efforts and installation of efficiency measures, which paralleled the aims of the project.

The authors then conducted a review of commercial and residential-use smart monitor brands to determine the most appropriate equipment to use in a school setting. After a comparison of seven representative options, the eGauge commercial monitoring device emerged as the product best suited to the specific project. eGauge met the following basic criteria:

1. Three-phase monitoring capability (common in larger buildings; some monitors intended for residential use can only attach to a single-phase supply);
2. Ease of installation (devices might be installed by Facilities, depending on the availability of third parties able to assist);
3. Live graphic readout included for free (some devices provide live visualizations on a subscription basis, which was undesirable for a project funded by a one-time grant).

Additionally, eGauge had a precedent history of successful use in school buildings (eGauge, 2019). One PSD school had even installed an eGauge unit several years earlier, so the technology was already familiar both to Facilities and to the local utility company who had assisted with the installation.

Beginning with schools that had previously participated in the pervasive energy game, the authors selected seven schools to use as pilot buildings for the monitor installation project. The list included five elementary schools and two high schools, representing a wide range of building sizes, ages, and student populations.

The authors then compiled a list of the additional hardware and device components that would be required to install eGauge units, assisted by the school buildings' utility providers. Each building would require the following components:

1. One eGauge Core data logger unit, which records and stores live energy data;
2. Three current transformers (CTs), which connect each supply phase to the data logger for reading; and
3. One eGauge display caster to transmit the included live graphic interface to a display screen.

PSD purchased all required equipment directly from eGauge after completing a comprehensive list. The school district received a small bulk discount from eGauge by ordering equipment for all seven buildings at once. The authors reimbursed PSD from the SEP grant afterward.

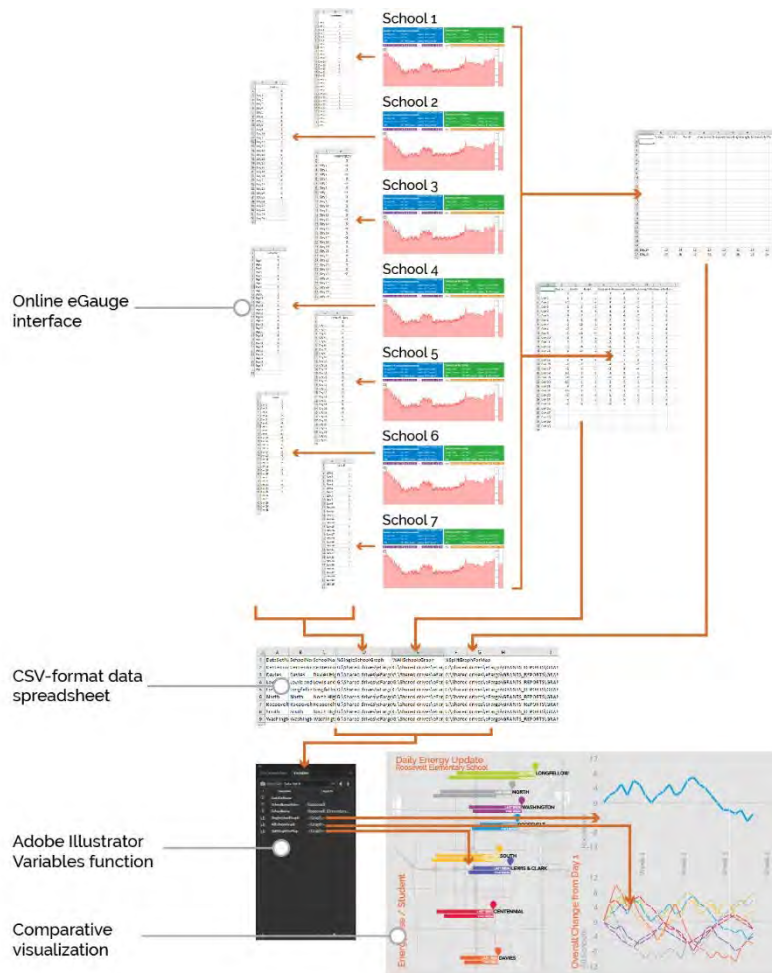
PSD requested bids from three local electrical contractors for equipment installation in all seven schools, including all necessary wiring and conduit work. The lowest bidder completed the work in coordination with Facilities.

The authors also reimbursed PSD for the purchase of eight large display screens for displaying real-time energy readouts to the students (one screen for each pilot school plus the one school that already had an eGauge installed). Facilities installed one screen in each school using their own resources, without bidding the work to contractors. Each screen was positioned in a prominent location where it would remain visible throughout the day, usually an entry lobby or cafeteria, or a high-traffic hallway.

After the eGauge equipment and display screens were installed, the authors and PSD coordinated with one of the local utility companies for assistance with programming the devices for display. The utility company had been involved in the prior eGauge installation at a PSD high school, and so was able to help ensure that the data logger was transmitting energy use information correctly.



## 4.2. Data collection and dissemination



**Figure 1:** Energy data flow from online eGauge interface to customized comparative visualization.

Despite being a concise and intuitive representation of energy use over time, the included free readout still came with several limitations. It was designed to display only one building's energy use at a time, while the authors required accurate comparisons between multiple buildings in real time to encourage energy saving competition as part of the serious game intervention methodology. The built-in display was also graphically difficult to understand or read by younger grade, difficult to see from a distance due to its monotone graphics and could have been more effective for outreach with data visualizations that utilized color, iconography, comparisons to build a visual narrative for the energy games implementation. Although eGauge offers some modification of the display and its programming, the company provides this service only to high-ordering bulk customers and for a substantial fee.

As an alternative visualization, the authors worked on a semi-automated protocol for collecting energy data and loading it into a separate custom display. The intended result was an improvement in the display's informational and aesthetic quality justifying a minimal sacrifice in reporting frequency.

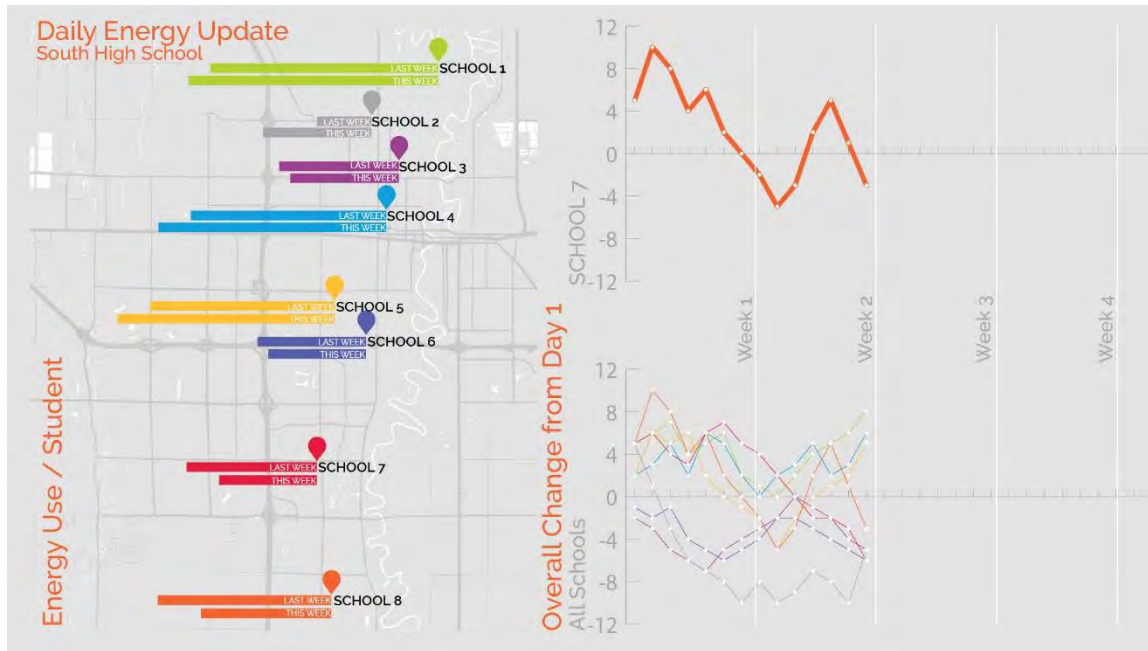
First, the authors developed a Python program to selectively collect data from the smart meters database and format it for data visualization. The program accesses each smart monitor's display interface, which is available online as a web page, through its unique URL and monitor ID number. Each monitor web page includes energy usage data in its source code, which the program parses to obtain the energy use logged in the last specified time period. With the addition of a loop function, the program can quickly circuit through other monitors' web pages and collect their energy use values.

After the program successfully parses and stores the energy use data from all monitors within the desired time interval, it appends the data to an Excel CSV file. The program uses this format for its readability in later stages of the protocol.

The program includes a scheduler function that automatically runs the above steps at 11:59 p.m. every day. After generating individual CSV files for each school building's twenty-four-hour energy use, the program saves them to a

specified hard drive location. Every time the program runs, it overwrites the previous day's files by saving the new CSV files with the same paths.

The customized graphic readout is designed as an Adobe Illustrator file. The Variables tool stores the paths for each energy data CSV file, imports their values, and plots them on Illustrator graphs. The custom interface contains three graphs, showing (1) a specific individual school's energy use to date, (2) all schools' energy use plotted on a single graph for comparison, and (3) a conceptual illustration of proportional change in consumption, related to each school's geographic position on a map underlay.



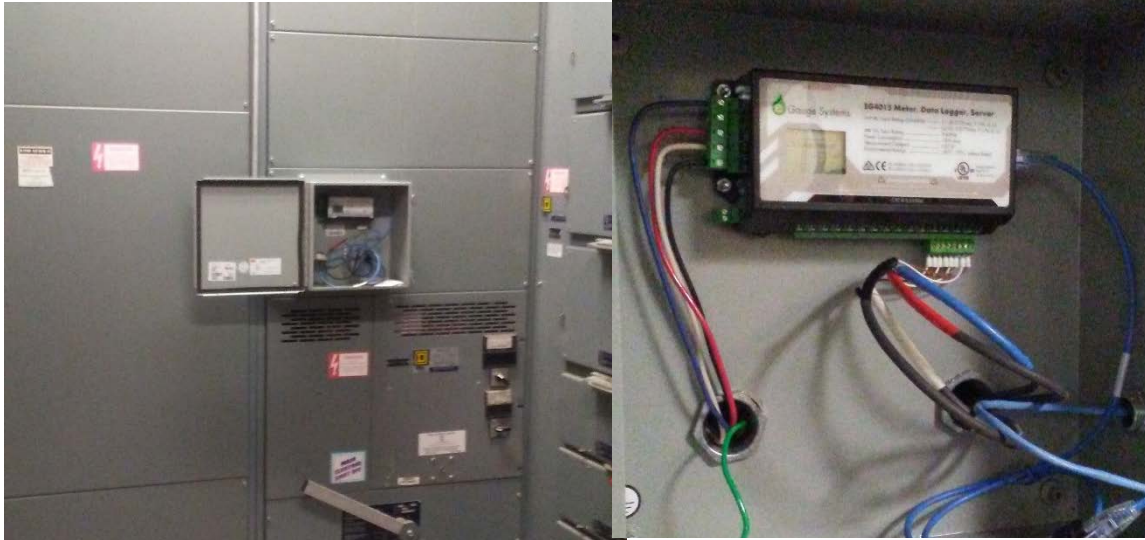
**Figure 2:** Comparative visualization of eight schools' energy use, including a specific isolated school at top right.

Because the Python program regularly overwrites the previous day's CSV files with new data, the paths stored in Illustrator remain current. To update the display, the authors refresh the Variables links, updating the graphs before initiating a process automated with the Actions tool that exports PDFs or images of each school's updated graphic interface. These files are then distributed to their respective schools, where they can be circulated on screens or printed and displayed.

Unfortunately, there is so far no practical way to make the custom interface show live data. The time period for data collection is variable, but for convenience of operation the interval has been kept to twenty-four hours. At present, the display screens installed by Facilities continue to show the built-in eGauge interface, keeping live data available in addition to the authors' customized representation.

## 5.0. RESULTS

All eGauge units were installed by a local contractor after three companies submitted bids for the work. In the seven pilot schools, the smart monitors were attached to electrical supply lines, brought online, and connected to wall-mounted display screens. Energy data from the eight total eGauge-equipped schools continues to transmit live to their online interfaces and dedicated display screens.



**Figure 3:** Installed eGauge data logger unit for data collection and visualization for Game-based Education



**Figure 4:** Dedicated display screen at a pilot school, showing the live eGauge energy graph.

The Python data collection program was tested using live eGauge data, demonstrating that the protocol accurately collects, organizes, and saves consumption data within the specified time frame. The Python program allows limited changes to the CSV formatting to accommodate future readability or transposition requirements.

The Illustrator workflow is also successful in conveniently generating energy use updates with the desired content and graphic style. The level of automation achieved through Illustrator's Variables and Actions tools allows the authors to spend as little as five minutes per day generating shareable files for all schools.

### 5.1. Limitations

Minor delays and complications occurred over the course of the documented approach. While formulating the lists of equipment needed at different school buildings, some confusion resulted from the fact that several schools were serviced by one utility company and other schools by another. Utility 1 told the authors that their buildings used older equipment and would require the additional installation of junction boxes to enable eGauge connections. The term "junction box" was unclear, as both Utility 2 and eGauge support representatives were uncertain as to what Utility 1 meant.

During the ongoing installation of eGauge devices in the seven pilot schools, several sets of eGauge equipment were found defective and had to be replaced. This resulted in several weeks' delay to the installations in those schools.

After the contractor installed the eGauge logger units and Facilities connected them to the dedicated display screens, the authors discovered that the loggers were not recording or transmitting accurate data to the display screens. Although Utility 2 was not directly involved in the installation work, a manager at the company who had previously worked with eGauge devices was available to diagnose a programming issue and work with Facilities to correct it.

As the authors worked on the Python/Illustrator graphics workflow, Facilities offered the use of small hallway-mounted display screens as a way to display the custom energy readouts to students. The authors therefore planned an entirely digital dissemination process. They discovered later that only two of the seven pilot schools had such hallway screens installed; an error in communication had left the misunderstanding that all seven schools had screens available. The best solution was to consider print formats for graphic circulation in addition to digital.

The SEP grant required that all purchases over \$3,000 receive at least three bids or include documentation that the price was as good or better than the amount a contractor would have paid as part of a bid. The authors reimbursed PSD for the purchase of all eGauge equipment from the manufacturer without bidding, but directed PSD to bid the installation work to local contractors. Therefore, the authors were required to demonstrate that any discounts a contractor would have received on eGauge equipment, had the equipment purchase been part of the bid, would not have resulted in a lower price than what PSD paid for the equipment directly. The authors discovered that PSD had only recorded the total amount of the equipment purchase, and did not have itemized records available. Eventually the best solution was to meet with PSD and eGauge to obtain signed letters affirming that the school district had paid the best possible price for the smart monitor units and corresponding hardware.

Due to the abrupt switch to distance learning in the wake of COVID-19, documentation of students' energy behaviors and reduced consumption as motivated by live energy visualizations was not immediately possible. With students not present in school buildings, building energy consumption cannot serve as a metric of student engagement and behavior modification.

## 5.2. Future work

As previously stated, smart monitor implementation enables the expansion of educational energy games beyond a limited geographical area by making energy data visible digitally from any distance. As COVID-19 restrictions continue to impact the number of students using energy in school buildings, future testing will include a game version that is fully asynchronous and not dependent on physical presence in a school building.

With all smart monitor equipment installed and verified functional, and the completion of a semi-automated protocol for collection and distribution of energy consumption data, all steps are in place for gathering building energy information and conveying it to students. When students do return to the classroom in person, immediate testing of the smart monitors' impacts on energy use will be possible.

As a more immediate implementation strategy, the authors are currently investigating potential introduction of the eGauge devices into existing environmental science curricula. Due to the uncertain timeline for a full return to in-person learning, the design includes alternate structures with varying durations for full in-person, hybrid, and distance schooling scenarios. By tracking behavior engagement and building energy use during any of these events, the authors will be able to document the effect of eGauge feedback in motivating action and habit development.

## 5.3. Discussion

The documented approach to installing smart energy monitors in school buildings is relevant to a discussion of energy efficiency in architecture, concerning both existing buildings and new construction.

First, live energy visualizations provide an opportunity for energy use improvements in older existing buildings that were not designed for efficiency. By targeting occupants' attitudes and behaviors, smart monitor implementations are an alternative to costly building upgrades. Smart monitors have the potential to generate returns far into the future as students continue to practice the habits they develop through seeing their energy use.

In addition, a clear goal of keeping energy use visible to building occupants can shape the design of future sustainable building projects, expanding on lessons learned in the documented project. For example, electrical rooms could be placed near central gathering spaces to reduce the amount of wiring and installation work necessary to connect a smart monitor logger in an electrical room to display screens in gathering spaces. Gathering spaces themselves, such as lobbies, cafeterias, or arterial hallways, could be designed with high-visibility points at which to mount energy readout screens. Other improvements to communication infrastructure in the design phase could enhance smart monitor use, such as placing small screens around the building for circulating daily updated energy graphics.

## REFERENCES

- Abdelhamid, N., Reim, P., Srivastava, M. and Christenson, M. 2020. "Geometric and thermographic visual analysis and score ranking of public buildings' comparative energy performance", *PLEA 2020 35th Conference on Sustainable Architecture and Urban Design: Planning Post Carbon Cities*. A Coruña, Spain.
- Christensen, R. and Knezek, G. 2018. "Impact of middle school student energy monitoring activities on climate change beliefs and intentions." *School Science and Mathematics* 118, no. 1-2. <https://doi.org/10.1111/ssm.12257>

- Coelho, A., Rodrigues, R., Nobrega, R., Jacob, J., Morgado, L., Cardoso, P., van Zeller, M., Santos, L. and Sousa, A. A. 2020. "Serious pervasive games." *Frontiers in Computer Science* 2, no. 30. <https://doi.org/10.3389/fcomp.2020.00030>
- DeWaters, J. E. and Powers, S. E. 2011. "Energy literacy of secondary students in New York State (USA): A measure of knowledge, affect, and behavior." *Energy Policy* 39: 1699-1710. <https://doi.org/10.1016/j.enpol.2010.12.049>
- eGauge. n.d. "eGauge + Renew Our Schools: Colorado schools see energy conservation and cost savings using eGauge devices." Accessed January 17, 2021.
- eGauge. 2019. "Monitoring system serves as foundation for energy efficiency at Little Elementary." August 16, 2019. <https://www.egauge.net/blog/2019/08/16/monitoring-system-serves-foundation-energy-efficiency-little-elementary/>
- eGauge Core [Apparatus]. Boulder: eGauge Systems.
- Faruqui, A., Sergici, S. and Sharif, A. 2010. "The impact of informational feedback on energy consumption: A survey of the experimental evidence." *Energy* 35, no. 4: 1598-1608. <https://doi.org/10.1016/j.energy.2009.07.042>
- Fell, M. J. and Chiu, L. F. 2014. "Children, parents and home energy use: Exploring motivations and limits to energy demand reduction." *Energy Policy* 65: 351-358. <https://doi.org/10.1016/j.enpol.2013.10.003>
- Montola, M., Stenros, J. and Waern, A. 2009. *Pervasive games: Theory and design*. Boca Raton: CRC.
- Srivastava, M. 2019. "Architecture as a gaming board in pervasive energy games." In *The Routledge companion to games in architecture and urban planning: Tools for design, teaching, and research*, edited by Marta Brkovic Dodig and Linda N. Groat. New York: Routledge.

# Visualizing Thermodynamic Flows in Architectural Research: Waste Heat Utilization in Data Centers

Sara Ghaemi<sup>1</sup>, Aletheia Ida<sup>1</sup>

<sup>1</sup>University of Arizona, Tucson, AZ

**ABSTRACT:** Hyperscale data centers (DCs) are now more than ever in the spotlight for energy conservation improvements due to rapid growth of the industry and greater dependency on virtual functions during pandemic social distancing conditions. The expansion in DC building sizes in combination with 24/7 usage of energy is leading to excessive waste heat production on interior spaces. This creates a unique opportunity for architects and engineers to examine waste heat flows and utilization in extreme, non-human occupancy spaces that might lend to insight for more general innovations in building cooling strategies. This paper introduces a novel idea for waste heat consumption through biofuel production from single cell algae, which are photosynthetic particles that are produced in photobioreactors (PBRs). Two types are investigated, including *Scenedesmus sp.* and *Chlorella Vulgaris*, which thrive in high temperature waters. The unique environmental conditions of DC spaces in combination with unique growth conditions of PBRs provide encouraging potentials for symbiosis: reducing waste heat and DC equipment cooling loads while simultaneously producing a renewable energy resource. More specifically, this paper demonstrates how visualization tools can assist architects to actively account for waste heat utilization through thermodynamic modeling and biogenic system integration.

**KEYWORDS:** thermodynamic flows, visualizations, waste heat, biomaterials, passive cooling

## 1.0 INTRODUCTION

This research addresses the excessive heat produced by data centers, which according to the office of Energy Efficiency and Renewable Energy "are one of the most energy-intensive building types, consuming 10 to 50 times the energy per floor space of a typical commercial office building. Collectively, these spaces account for approximately 2% of the total U.S. electricity use" (Strutt et al. 2012). During the COVID-19 pandemic, the reliance of communities on data center infrastructure anticipates an increased insurgence of their rapid growth. In some ways, because of the extreme heat generation from densely packed information technology (IT) equipment, the data center provides a unique testbed for architectural systems research that may lend to future low-energy and reduced embodied carbon footprint solutions for buildings in general.

Energy in the form of excessive heat is often considered problematic to either human comfort or machine functionality. Many modes of heat removal by mechanical systems are based on thermodynamics of sensible and latent content of air mixtures and require large amounts of energy input to modify the air-mix to achieve a reasonable temperature. According to the International Energy Agency, "Cooling is the fastest-growing use of energy in buildings. Without action to address energy efficiency, energy demand for space cooling will more than triple by 2050 – consuming as much electricity as all of China and India today" (IEA 2018). Current methods of waste heat utilization are reviewed for district-scale and building-scale examples, including those in Scandinavia and the US. In some cases, the large-scale data center waste heat is coupled to heating needs for housing at district scales (Malkawi et al. 2018), while in other cases edge-cloud data center waste heat is utilized directly within the same building for low-income residential units enabling reduced energy costs and open access to internet (Litvak 2017). In addition, the design research presented here focuses on system-scale waste heat utilization through biomaterials, or biogenic systems, both for carbon sequestration and biofuel production.

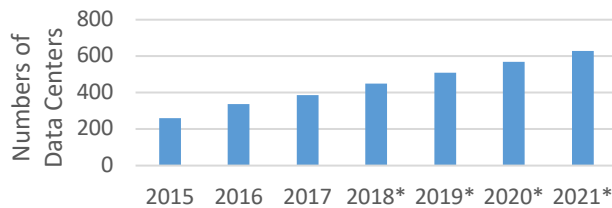
With this work, one of the useful tools for defining the thermodynamic flows and identifying useful waste heat output is the Sankey diagram, which provides a visual indication of relative energy values and states across the comprehensive building design. While such diagrams are regularly referenced in engineering disciplines, the architect has yet to adopt these into regular practice for visualizing entropy to inform thermodynamic spatial practices. In addition, the work demonstrates the importance of integrating empirical material prototype testing to obtain measured values for inputs into system and building-scale energy simulation analyses. In combination, these co-linked tools and methods provide insight for architectural research and design by emphasizing the potential relationships of energy flows, materials, and functions (Smith 2015). Integration of such techniques in the design process might allow us to shift away from an increased dependency on high-energy cooling systems and ultimately improve the performance of buildings. The paper



examines current trends and an innovative solution for data center waste heat utilization, along with useful tools that enable integration between thermodynamic flows and biogenic systems.

## 2.0 DATA CENTERS

Data centers (DC) are service facilities used to store, process, collect, and manage data. As internet and artificial intelligence (AI) technologies are spreading their roots through every aspect of societies and their economy, the number of these DCs proliferates. Now, with the ongoing COVID-19 pandemic, their indispensable role in communication, business, academic, and governmental systems have become even more transparent. These facilities can be categorized by their size and number of server racks containing their essential hardware, this article will be concentrating on hyperscale DCs that are growing rapidly in number and are expected to pass 600 during 2021 (Fig. 1). Hyperscale DCs are buildings with a footprint of 5000ft<sup>2</sup> or more that house at least 500 information technology (IT) cabinets, which are usually owned and administered by companies such as Facebook, AWS, Microsoft, Google, Amazon, and Apple. Moreover, these companies offer a wide range of data management services to individuals and businesses (Fig. 2).



**Figure 1:** Number of hyperscale data centers worldwide, from 2015 to 2021: (Holst 2020)



**Figure 2:** Cabinets inside Facebook's Lulea data center (left) and an inside look at one of QTS Realty Trust's data centers (right): (Facebook 2016 (left), Lieberman 2020 (right))

### 2.1 Energy use and waste heat

The importance of examining DCs is derived from their excessive energy usage pattern. The amount of energy consumption per floor space in these buildings is 10-50 times higher than a typical commercial office building; however, this is not solely the result of IT equipment. IT equipment usually runs 24/7 and 30 days a month, and the energy consumed to operate the IT equipment is converted to excessive heat with the need to be removed from these delicate systems to be able to work safely and reliably. High temperatures can cause damage and system breakdowns, disrupting the omnipresence of widespread data. The excessive heat is then either removed by mechanical ventilation and air conditioning system return-air cycles or directly exhausted into the atmosphere (Jouhara et al. 2018). Unlike other industries with high temperature waste heat that can be converted to electricity, the temperature of the waste heat in DCs is lower than 100°C and thus categorized as low-grade waste heat, which can be more challenging to utilize. 40% of DCs total energy use is allocated to cooling the IT systems and maintaining their strict operating temperature and humidity levels. Based on the 2008 ASHRAE recommended psychrometric envelope for data centers, the ideal temperature range is between 64-80°F while temperatures between 59-90 °F are allowable (ASHRAE 2008). Additionally, the humidity levels are recommended to stay proximate to 60% relative humidity (RH) with an allowable range between 20% - 80% RH (Fig. 3).

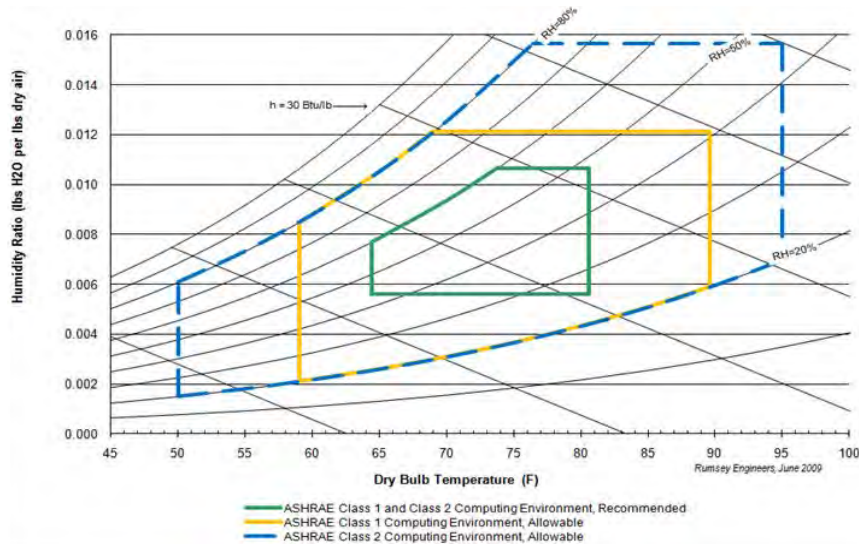


Figure 3: Psychrometric envelope chart for computing environments: (ASHRAE 2008)

### 3.0 WASTE HEAT UTILIZATION METHODS

In order to plan for utilization of waste heat, the forms of energy should be identified and categorized by their concentration and qualities. Thermodynamic visualization and energy analysis of the building can provide the information needed to support architects and engineers in calculating and planning the amount of waste heat that can be utilized, the scope of its usage, and appropriate systems to be implemented in the design. In temperatures higher than 80°C (176°F) industries can utilize their excessive heat and recover it through waste heat recovery technologies such as organic Rankine cycle, Stirling engines and condensing boilers, with the ability to upcycle the waste heat and generate electricity. A diverse range of waste heat usage occurs across temperatures starting at 30°C upwards to 1650°C (Fig. 4). The temperature of the DC IT processor waste heat fluctuates between 35°C to 45°C depending on grade of processor units.

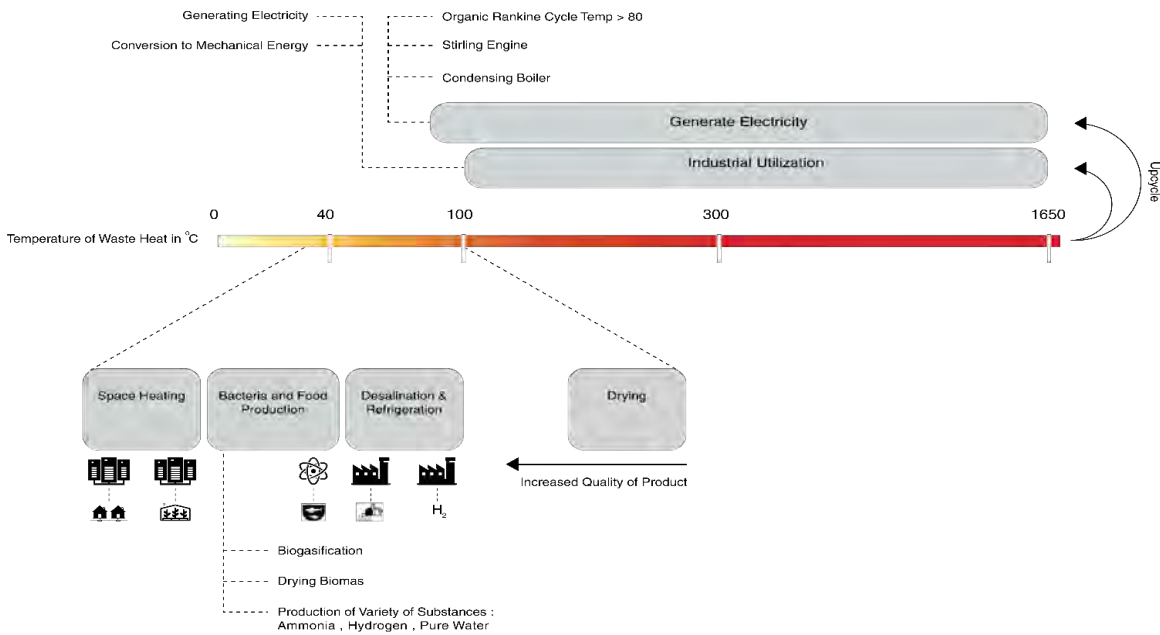


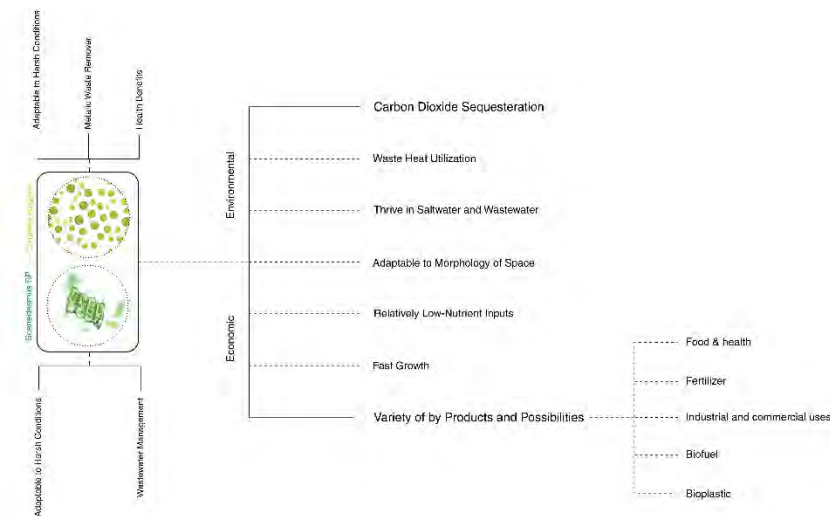
Figure 4: Common waste heat utilization processing based on temperature range (drawn by Sara Ghaemi based on Parker & Kiessling 2016; Juhara et al. 2018; Kocer 2004)

At a district scale, the most straightforward use for low-grade waste heat is for space heating. By using ventilation and floor heating, temperatures as low as 40°C can be used to heat houses; an example of this is Scandinavian countries utilizing waste heat to heat the approximate neighborhoods. If the communities replace burning fossil fuel with waste heat, environmental benefits can be invaluable. A worthy example would be waste Stockholm's Data Park preparing to heat 10% of the city with heat produced by data centers by the year 2035 (Holla 2020). Heating, unlike electrical power can be relatively easily stored, but is difficult to transport. Therefore, "direct heat use will depend on whether [a] potential user can be found" (Parker & Kiessling 2016). Besides residential space heating, greenhouses can be a viable cooling source in winters or northern climates (Parker & Kiessling 2016).

The district heating methods are not viable throughout the entire year in most regions. Other than space heating, low-grade heat can be utilized by industries in refrigeration and desalination in temperatures as low as 45-50°C without additional mechanical work conversion. Additional uses include bacteria growth, typically at 37-38°C, bio-gasification, drying biomass, and production of various substances, including but not limited to ammonia, hydrogen, and pure water (Parker & Kiessling 2016). Moreover, by utilizing the heat in photobioreactors (PBRs), some algae species can grow at higher rates and become more efficient. Also, the excessive heat can be further utilized to dry biomass which is an energy-intensive activity that can become energy efficient by using industrial waste heat, making the by-products more affordable and thus attainable.

#### 4.0 BIOGENIC MATERIAL BENEFITS

As mentioned, waste heat can be utilized to produce biomass and protein and eventually be used even further to dry these resources for usage. Figure 5 summarizes algae's benefits and qualities that can clarify the benefits of their production by DCs waste heat utilization.



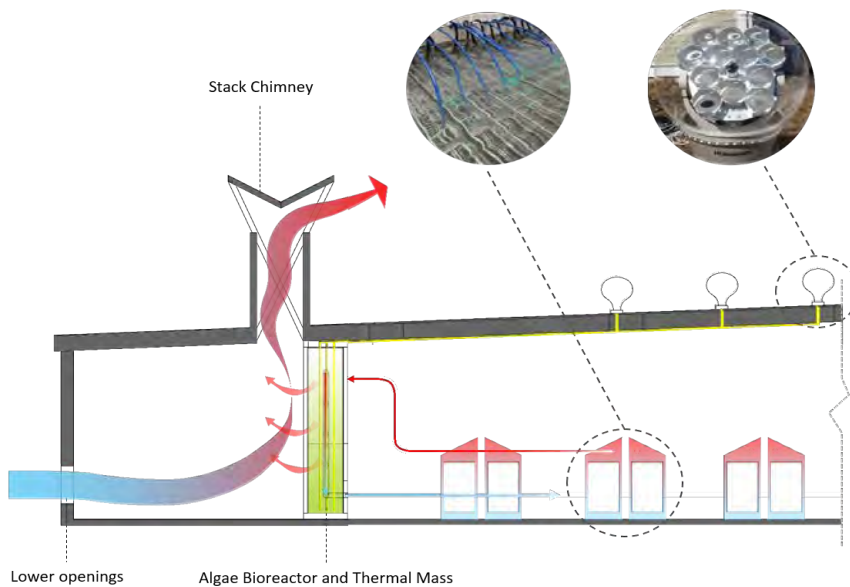
**Figure 5:** Types and benefits of algae and related growth mechanisms (Sara Ghaemi 2020)

The benefits of algae can be grouped under two major categories: environmental benefits and economic benefits. Environmental benefits include (but are not limited to) Oxygen production and CO<sub>2</sub> sequestration, waste heat utilization, and water filtration due to reproduction in saltwater and wastewater. The economic benefits of algae include their adaptable morphology to space: bioreactors can be built in any size and different forms that can adapt to their host settings and, unlike trees and other plants, their growth is dependent on their base container for their size and shape. In addition, they require low levels of affordable and readily available nutrients that can be provided through different medium types, including but not limited to Bold's Basal Medium and freshwater medium. Furthermore, the species being studied demonstrate fast growth rates, providing potential for rapid biofuel production. With *Chlorella Vulgaris* (*C. Vulgaris*), a growth rate range of 25-32 mL/hr can be achieved, while for *Scenedesmus sp* (*Scenedesmus*) a growth rate range of 30-41 mL/hr can be achieved; both species growth rates are dependent on the medium being maintained at a constant pH value of 7.5 and temperatures around 25-30°C (Cassidy 2011). And, at last, there are a variety of products that can be produced by growing these unicellular organs: food and health products such as newly emerging food supplements, vegetable oil, and pasta; fertilizers for plants with their complete amino acid profile; industrial and commercial uses such as animal feed for the meat industry; and bioplastics. The byproduct of interest for introducing an algae-based heat-sink into data centers is for biofuel production.

#### 4.1 Algae-based heatsink system

Although waste heat in DCs is counted as low-grade heat without the potential to be upcycled and transformed into electricity (upcycle need 80°C/176°F or higher), this heat has two significant advantages: one being it is concentrated on the surface of processors, and two being its constant temperature which makes it a reliable source of energy throughout the entire year. In this regard, the concept is to utilize the excessive heat in a secondary energy cycle to produce biofuel and simultaneously sequester carbon dioxide. The algae photobioreactors absorb and retain the waste heat during the day while reproducing at a higher pace. At night, the PBRs can be cooled through passive cooling methods such as night flush cooling and stack ventilation. To understand DCs energy consumption, the amount of cooling needed, and to find the primary source of heat, tools such as energy simulation models, Sankey diagrams, and CFD models were utilized. Primary experiments were conducted on the two earlier referenced algae species – *C. Vulgaris* and *Scenedesmus*. These two species thrive in warmer waters ranging from 30°C - 40°C (86° - 104° F), which are validated through testbed growth experiments. Based on the information acquired from the visualizations, empirical data, and simulations, different forms of the algae-based heatsink were designed (Ghaemi 2021).

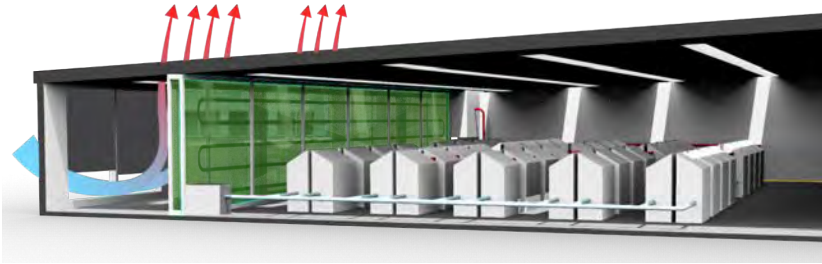
One example examines coupling liquid cooling systems with PBRs; in these cooling systems a high capacity, nonconductor liquid called 'Electrosafe' is used to remove the heat from the surface of the servers and pass it through the algae solution where it can heat the water. The heated PBRs holding a mix of *C. Vulgaris* or *Scenedesmus* (depending on the source of water available to the DC) with water and nutrients acts as a thermal mass for the building and collects the heat during the day when the outdoor temperature is too high for ventilation, and the building envelope is closed (Fig. 6). At night, when the outdoor temperature is lower, outdoor air is introduced to the building from openings on the lower section of the wall. As heat dissipates from the mass, it rises and allows cooler air to replace it. A strategy used to enhance the ventilation flow is using a stack chimney to induce the Venturi effect and increase the sufficient height of the exhaust outlet.



**Figure 6:** Night flush cooling and stack ventilation effect: (Sara Ghaemi 2020)

Solar collectors and optic fibers are used to introduce light into the PBRs but prevent heat exchange with the sun (Fig. 7). Additionally, they are duplicated with light emitting diodes (LEDs) to keep a sufficient amount of light for the system during the evenings and on cloudy days. The design is based on thermodynamic principles that heated liquid rises in the container and is removed as cooled liquid enters from the lower sections of the container (where heat was removed from Electrosafe chilled water exchange), creating a fluid and convective heat exchanger.





**Figure 7:** IT racks and algae-based heat-sink: (Sara Ghaemi 2020)

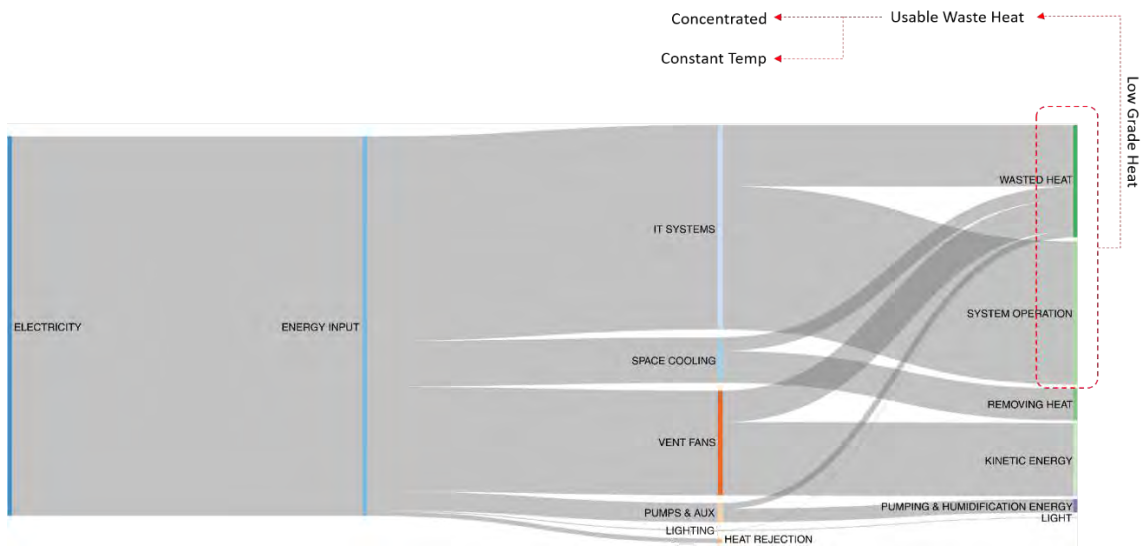
In general, the proposed algae-based heatsinks can provide numerous multifunctional benefits to data centers. Cooling system dependency is reduced as heat is directly removed from the IT racks by conduction into the algae heatsink, which can be incorporated with high heat capacity fluids such as water or the Electrosafe solution. When coupled with natural ventilation methods, the proposed system further reduces the dependency on HVAC cooling energy. The overall carbon footprint of the building is reduced considerably and, in fact, may achieve net-zero carbon because of the carbon absorption occurring through the algae biogenic processes. The algae-based system is capable of producing useful renewable biofuel, which could provide an alternate form of energy to power the data center operations. When combined with solar power, the biofuel sourced from the renewable algae system could lead to net-positive energy producing data centers. The overall impact of a single biogenic system on data center energy consumption and market potential for owners to realize utility bill savings and clean energy production is quite immense.

## 5.0 VISUALIZATION AND ANALYSIS METHODS

A hyperscale data center in Phoenix, Arizona was chosen, modeled, and analyzed as the base-case for this study. The hot-arid climate context provides additional cooling energy demand as well as water resource limitations. The authors had access to an anonymous proposed hyperscale data center drawing and specification set for which to base the analysis assumptions on. As DCs are internal load-dominated buildings, an isolated typical co-location (COLO) room was identified to simplify the simulation for assessing typical energy flow results.

### 5.1 Thermodynamic flows

The following Sankey diagram (Fig. 8) was illustrated according to the results produced from the base-case energy model set up in eQUEST (v3.64). As shown in the diagram electricity is divided into two main sections, which approximately 50% of the total energy is dedicated to IT systems, and one-third of that directly transforms into waste heat, and the other two-thirds, once used as the energy for the operation of the network, ultimately become additional waste heat, with a constant temperature of 95°F-113°F, and a concentration on the surface of the IT processors, in this regard we can utilize the heat as a primary energy source to produce and dehydrate biomass.

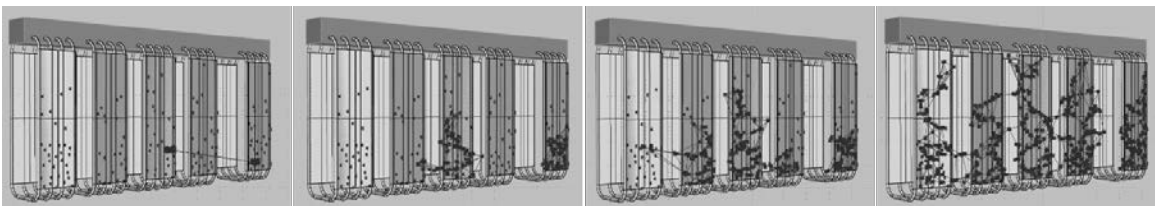


**Figure 8:** Sankey diagram depicting energy utilization in data center building operations, with low grade waste heat for re-use at output: (Sara Ghaemi 2020)

The Sankey Diagram is a useful tool that can allow the designer to visually absorb the information presented in charts and numbers. These diagrams allow for simple reasoning and easier information finding. Also, one can easily follow conjunctive information from their source to result and visually compare all parts holistically. Based on the produced Sankey diagram, it is clearly seen that electricity as an input is primarily utilized for IT systems and ventilation fans with secondary uses attributed to space cooling, pumps, auxiliary lighting, and heat rejection. All forms of energy are transformed (degraded) in some fashion or absorbed by system operation and kinetic energy. Ultimately, about half of the total energy consumed is converted to waste heat with a constant temperature and concentration. The proportion of each category can be studied relatively, allowing one to indicate the problem in a shorter time and with less examinations.

## 5.2 Biogenic material flows

*Physarum Polycephalum (Polycephalum)*, which evolves and transforms constantly throughout its life, is a slime mold that ranges from a microscopic amoeba to a multinucleate syncytium that can expand in shady, moist environments. This slime is known for its abilities in problem solving; in 2010 scientist were able to develop an experiment with a starting point as the center of Tokyo and oats surrounding it as suburban railway stations, in which they replicated the cities railway system in 26 hours; a network that took decades to be designed and expanded (Nakagaki 2010). Based on *Polycephalum*'s behavior, a plugin was developed for Rhino software that allows designers to better understand the growth and patterns of these astonishing beings and use their ability in problem solving for food, to create natural forms and structures, and to study urban networks. In this research the plugin was used to create connections between heat conductors to keep the temperature of the algae solution constant throughout the entire PBR, based on thermodynamic rules the higher temperature solution would be moving to the upper levels of the PBR leaving the algae at the levels closer to the ground in lower temperatures (Fig. 9).



**Figure 9:** Algae heat conductor connections following *Polycephalum* growth pattern: (Sara Ghaemi 2020)

Algae behavior is not as evolved as *Polycephalum* and does not create artistic patterns but similar tools for algae growth can be developed to allow architects to predict the growth pattern of algae and use it more commonly in their building designs. Currently, there is one completed building using algae in its façade in Hamburg, Germany (Rackard 2013). However, this unique source of renewable energy, carbon sequestration, and oxygen production has not been embraced to the extent of building integrated solar energy technologies.

## 6.0 DISCUSSION

In the midst of intense socio-environmental climate change and pandemic challenges with increasing temperatures and greater dependency on the internet, the data center energy challenge places new paradigms for cooling system processes front and center. Through this unique building type, adjustments to our design methods are considered for translating thermodynamic flows into synergistic growth patterns of biogenic material systems. The work demonstrates how waste heat recycling can be transformed into a useful resource for biofuel production. Different avenues for the biofuel resource could emerge, whether for the direct use by the data center industry or as a co-benefit to the communities they are situated within and associated with. The increasing number of hyperscale data centers worldwide and their 24/7 format can be a reliable heat source due to its abundance and concentrated nature. Visualization of the energy consumption and its byproducts can allow engineers and architects to actively consider waste heat as a resource and plan for it in the design process. While the discrete models and tools utilized in this study are previously developed by others, the implications for further advancing tools at the intersection of thermodynamics and biogenic systems for architectural design and research are significant. We anticipate a prevalent and necessary shift of architectural design tools and methods to more deeply integrate biosystems engineering concepts and processes.

## ACKNOWLEDGEMENTS

Research conducted in support of this scholarship was partially funded through a University of Arizona Accelerate For Success (AFS) grant (2018-2019) and a Microsoft Datacenter Engineering grant (2018-2019).



## REFERENCES

- ASHRAE. 2008. *ASHRAE Environmental Guidelines for Datacom Equipment - Expanding the Recommended Environmental Envelope*. American Society of Heating, Refrigerating and Air-Conditioning Engineers, Inc.
- Cassidy, K. O. 2011. *Evaluating Algal Growth at Different Temperatures*. Thesis, University of Kentucky: Biosystems and Agricultural Engineering.
- Ghaemi, S. 2020. *Innovative Algae-based Heatsink for Data Center Integration*. Thesis, University of Arizona: School of Architecture.
- Holla, K. 2020. Waste Heat Utilization is the Data Center Industry's Next Step Toward Net-Zero Energy. *Voice of the Industry*, August 21, 2020. <https://datacenterfrontier.com/waste-heat-utilization-data-center-industry>.
- Holst, A. 2020. Global figure of hyperscale data centers 2015-2020. *Statista*, September 14, 2020. <https://www.statista.com/statistics/633826/worldwide-hyperscale-data-center-numbers>.
- IEA. 2018. *The Future of Cooling Opportunities for energy-efficient air conditioning*, IEA, Paris: <https://www.iea.org/reports/the-future-of-cooling>.
- Jouhara, H., Khordehah, N., Almahmoud, S., Delpech, B., Chauhan, A., & Tassou, S. A. (2018). Waste heat recovery technologies and applications. *Thermal Science and Engineering Progress*, pp. 268-289.
- KOÇER, C. 2004. Waste Heat Recovery Techniques. *Academia*, August 18, 2020. [https://www.academia.edu/17471264/WASTE\\_HEAT\\_RECOVERY\\_TECHNIQUES](https://www.academia.edu/17471264/WASTE_HEAT_RECOVERY_TECHNIQUES)
- Lieberman, L. 2020. OP company rates as world's most sustainable data center operator. *Kansas City Business Journal*, January 2020.
- Litvak, Emily. 2017. In Harlem, a Digital Renaissance Takes Shape. *University of Arizona Research, Innovation and Impact*, November 3, 2017. <https://research.arizona.edu/stories/harlem-digital-renaissance-takes-shape>.
- Malkawi, A., Nygaard, M., Beim, A., and Stenberg, E. 2018. *Sustainability in Scandinavia: Architectural Design and Planning*. Edition Axel Menges GmbH.
- Nakagaki, T., Tero, A., et.al. 2010. Rules for Biologically Inspired Adaptive Network Design. *American Association for the Advancement of Science*, pp. 439-442.
- Parker, T., & Kiessling, A. 2016. Low-grade heat recycling for system synergies between waste heat and food production, a case study at the European Spallation Source. *Energy Science & Engineering*, pp. 153-165.
- Rackard, R. 2013. World's First Algae Bioreactor Facade. *Archdaily*: <https://www.archdaily.com/339451/worlds-first-algae-bioreactor-facade-nears-completion>.
- Smith, S.I. 2015. Interscalar Entropy of Dynamic Medium Flows for Metabolic Building System Design Efficacy. *Building Technology Educator's Society 2015 Conference Proceedings*.
- Strutt, S., Kelly, C., Singh, H., and Smith, V. 2012. Data Center Efficiency and IT Equipment Reliability at Wider Operating Temperature and Humidity Ranges. *The Green Grid White Paper*, WP#50, Oct. 23, 2012.

# User-Driven Emergent Patterns of Space Use in Vertically Integrated Urban Environments

Srilalitha Gopalakrishnan<sup>1</sup>, Daniel Wong<sup>1</sup>, Ajaykumar Manivannan<sup>1</sup>  
Roland Bouffanais<sup>2</sup>, Thomas Schroepfer<sup>1</sup>

<sup>1</sup>Singapore University of Technology and Design, Singapore

<sup>2</sup>University of Ottawa, Ottawa, Canada

**ABSTRACT:** Public and common spaces in integrated mixed-use buildings in high-density urban environments increasingly take on the form of vertical extensions of public and common spaces on the ground level. Taken together, they can be understood as networks with multiple spatial programs, diverse land use, multi-occupancy, and circulation paths set in complex three-dimensional relationships. This paper argues that studying high-density vertically integrated buildings based on user-generated data can contribute to a better understanding of their socio-spatial performance. It presents aspects of an ongoing research project at the Singapore University of Technology and Design (SUTD) that uses a Complexity Science-based approach to study movement and space use in vertically integrated developments. The case study presented in this paper uses the SUTD Campus, an award-winning urban design and architectural project by Amsterdam, The Netherlands-based UN Studio and Singapore-based DP Architects as a case study. The project consolidates a typically laterally spread-out campus program into a compact and vertically layered interconnected building complex. The paper presents a systematic post-occupancy socio-spatial study using the following methods: (1) qualitative architectural analysis, (2) quantitative spatial network analysis, (3) quantitative data collection, and (4) correlation analysis of actual performance with spatial network patterns. It discusses the use of infrared outdoor people counters, low-energy Bluetooth (BLE) devices, and smartphone sensors to map user movement. The collected data is subsequently analyzed to demonstrate how the public and common spaces within the integrated campus perform. The paper further explores the influence of the campus' spatial layout on user behavior and movement patterns, and the impact on social interactions and user activities over time. The paper finally discusses the potential of this research methodology to inform the future planning and design of vertically integrated mixed-use developments.

**KEYWORDS:** Spatial performance, Spatial Network Analysis, Complexity Science, Bluetooth localization; mobility patterns

## INTRODUCTION

To accommodate growing urban populations in many parts of the world, planners, designers, and architects increasingly experiment with integrated mixed-use buildings as vertical extensions of urban space. Such buildings are often combined with others and feature extensive program networks. They are characterized by public and common circulation paths and spaces located on multiple levels. Vertically integrated buildings can be studied as complex systems. They display properties similar to those that play out in their larger urban context to understand their users' spatial and social interactions systematically.

Just as the city manifests itself as a space of flows (energy, resources etc.) (Kennedy et al., 2011), the same applies to vertically integrated buildings. Generally, a building's spatial configuration forms the network in which these flows take place. Hence a spatial network determines the pace at which processes occur. While buildings and their spaces are typically designed for socio-spatial efficiency, their actual performance is emergent. Complex patterns of emergence are visible in cities as we study social networks, transportation networks, spatial networks, etc. through statistical analysis and other methods used in Complexity Science. (Batty, 2009) With the proliferation of vertically integrated buildings in high-density urban environments, often designed with public and common programs on multiple levels, buildings become vertical extensions of the urban public and common environment they are part of. The interactions of spaces on elevated levels with those on the ground level and their impact on human movement patterns and space use patterns are numerous, varied, and interrelated in complex ways. The study of vertically integrated buildings therefore warrants the use of Complexity Science methods. These encompass spatial and social network analysis using Network Science that understands human mobility as a dynamic process occurring within a complex network.

## 1.0 CONTEXT AND THESIS

### 1.1. Performative Scales: City and Building

In Singapore's compact high-density urban environment, urban planners, designers, and architects increasingly experiment with vertically integrated mixed-use buildings. In response to the City State's land scarcity, smaller building footprints with public and common spaces on elevated levels such as sky bridges, parks, terraces, and roof gardens, are combined with residential, civic and commercial programs, resulting in 'vertical cities.' (Schröpfer, 2020).

The SUTD Campus by Amsterdam, The Netherlands-based UNStudio and Singapore-based DP Architects located in the Southeast of Singapore, is one such built experiment of vertical spatial distribution. The project consolidates a typical laterally distributed campus program into an interconnected compact integrated complex of buildings. According to UNStudio, the project's design architect, the buildings' organization is based on a mathematical diagram referring to Knot Theory and UN Studio's Design Models (Schroepfer 2017, 85). In UNStudio's practice, the principles and parameters are developed from one project to another as a chronological lineage of buildings' design development.



**Figure 1(L):** UN Studio/DP Architects, SUTD Campus, Learning Spine with bridges on Levels 3 and 5 linking buildings, view from the East. (Photograph: Daniel Swee 2017)

**Figure 2(R):** 'Living Spine' with elevated gardens and bridges view from north. (Photograph: Daniel Swee 2017)

New spatial concepts of buildings can benefit from new methods of analyzing and predicting their post-occupancy performance. Building performance is typically evaluated quantitatively using various environmental, ecological, biodiversity, and economic data. However, addressing spatial performance in the design phase typically relies on the experience of practitioners. This is also the case in the multifaceted systems of vertically integrated buildings. Given the complexity of these buildings, there is a need to develop systematic methods to understand and measure their spatial performance and design effectiveness. The main question we are addressing in this paper is: Is the design of the SUTD Campus meeting its designers' intentions regarding circulation, flow, and collaborative spaces both on the ground and elevated levels, and if not, how could it be designed better?

### 1.2. Hypothesis and Objective

We hypothesize that a Complexity Science-based analysis of the spatial networks of vertically integrated buildings, compared with empirical post-occupancy user data, allows for identifying and quantitatively evaluating emergent space use patterns that become a basis for better future design. To that end, as part of our larger research, we are developing systematic methods that allow for the Complexity Science-based analysis of urban and architectural spaces. These methods include (1) qualitative architectural analysis, (2) quantitative spatial network analysis of patterns of spatial relationships, (3) quantitative data collection of human movement and activity and (4) correlation of actual performance with spatial network patterns. In summary, we evaluate ground and elevated spaces to review the effectiveness of their design.

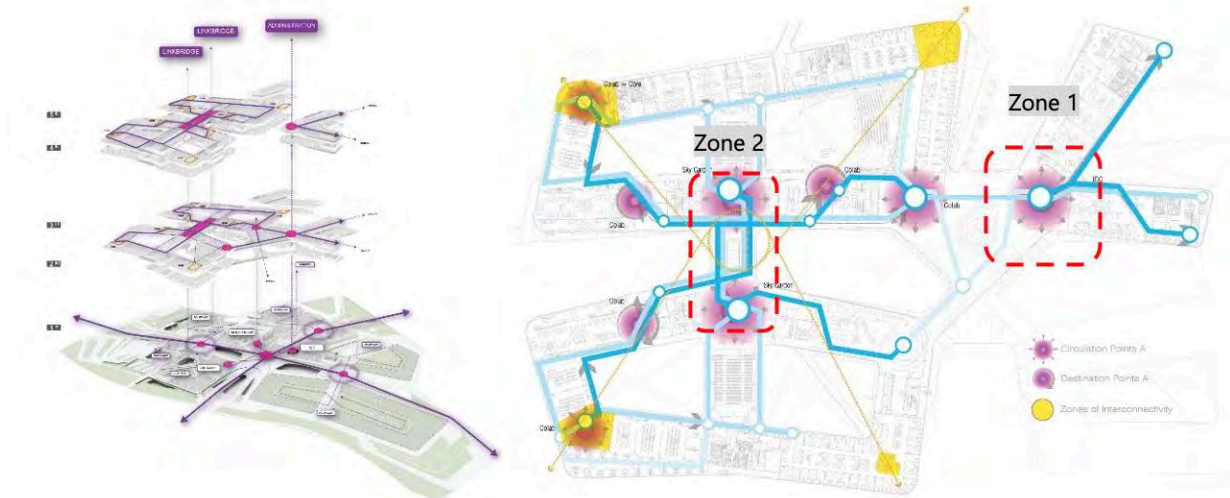
## 2.0. METHODOLOGY

Our research has three main phases, (1) the mapping of the design intent and the resulting spatial relationships (architectural analysis) and (2) the collection of actual user data. The resulting data allows for (3) a comparison of design intent and actual space use and, thus, evaluating the building's performance.

### 2.1 Design Intent Mapping and Architectural Analysis

Our study's design intent mapping and architectural analysis were based on materials provided by the design architect. They included architectural diagrams and drawings that illustrate the intended spatial circulation and flow, collaborative zones, connections between buildings and across the entire campus, and functional lateral and vertical distributions of

programmatic spaces. The concepts of Circulation and Interaction (Schroepfer 2017, 79-80) served as the two central conceptual guides - with horizontal, vertical, and diagonal flows (e.g., see Figs. 3 and 4) connecting the various spaces of the project's four main buildings. UNStudio designed two main axes of circulation, the Learning Spine and the Living Spine with a central plaza at the center.



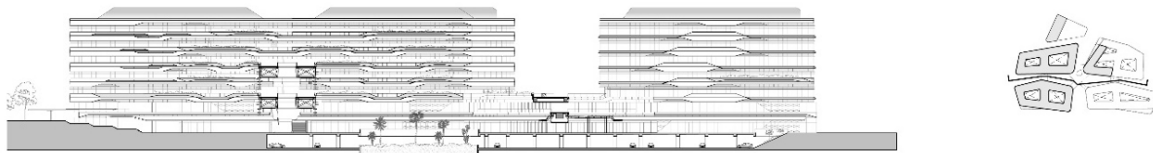
**Figure 3(L):** Lateral and vertical circulation, Collaborative zones. (Source: UNStudio 2006)

**Figure 4(R):** Conceptual diagram of nodes of interactivity connected by circulation paths. (Source: UNStudio 2006)

In the context of vertically integrated buildings, the bridge connections, which exist on the ground and elevated levels, were designed to serve as important collaborative zones. They are, therefore, suitable locations for testing our hypothesis. We studied two locations, (1) the main intersection of the circulation axes of the Campus Center at the Ground Level and the Level 2 and 3 Gardens, and (2) the connection between the Buildings 1 and 2 on the Ground Level Plaza and the Level 3 and 5 bridges.

## 2.2. Spatial Network Mapping

Spatial networks are a type of complex system. The topology of nodes and edges are embedded in space (Barthelemy, 2011). In our study, we extracted the nodes from main program areas and generated edges by connecting each node to other program areas that are spatially accessible via doorways and corridors. The Euclidean distance between the nodes was assigned to their corresponding edges, as is the case for spatial networks. For our study's purposes we consolidated adjacent elevator cores and staircase lobbies as a single node and connected them directly to all other vertically adjacent lobby nodes, thus considering elevator and stair cores as 'vertical streets' with lobbies on each floor as node points.



**Figure 5:** Cross-sections of (i) Block 1 and 2, (ii) Lecture Theatre, (iii) Learning Spine. (Source: UNStudio 2006)

## 2.3. Spatial Network Analysis: Centrality Measures

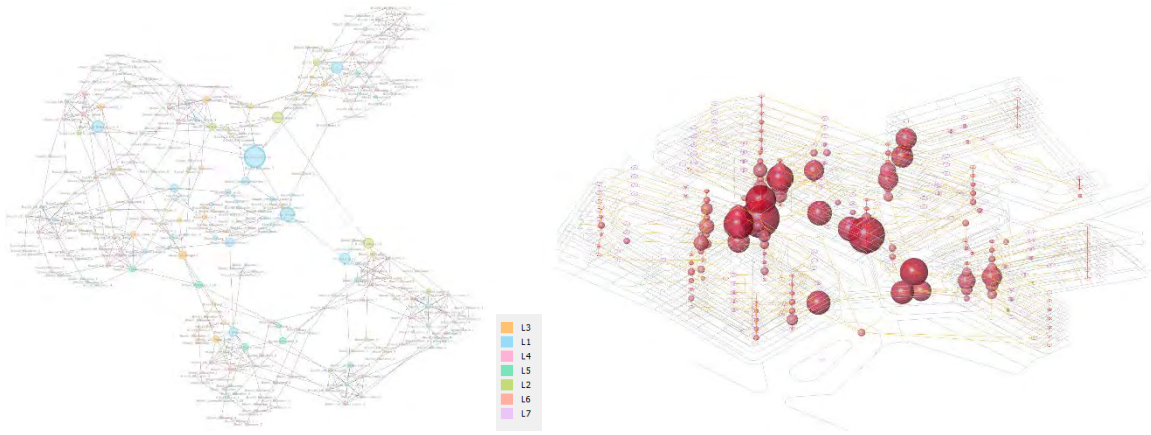
Our study's different centrality measures are extracted from the spatial networks by using digital tools including Rhinoceros3D, Grasshopper, Python script, Gephi software and Networkx Python Library. Network centrality measure algorithms used included 'degree', 'closeness', and 'betweenness centrality', all essential measures that assess the local centrality of nodes in a system (A. Barrat et al., 2004)

Degree centrality is a measure of a node's significance in its connectivity, based on the number of its edges. The higher the degree number, the more connected the node is within a network. This measure helps find the most connected

spaces or influential individuals within a spatial or social network by ranking them within a network. Determining the degree centrality score allows for the effective planning of active social spaces that act as critical connectors within a development. E.g., the Community Plaza at the SUTD Campus Center forms a high-degree node as it connects the development's vertical spaces with their larger urban context.

The closeness centrality scores of each node are based on its closeness to other nodes in the network. The closeness measure is calculated using the shortest paths between each node and is even across all nodes for a highly connected network. Closeness measures help identify spatial clusters within a development, highlighting the spatial distribution of high degree nodes. Our design intent analysis showed that the collaborative zones of the SUTD Campus are organized along the central circulation axes. They act as bridges to the spatial clusters of the other buildings. Therefore, they are likely to display similar closeness centrality if the spaces' circulation design allows all the program nodes to be highly connected.

Betweenness centrality is one of the critical centrality measures for spatial networks. It characterizes a node's importance by measuring its ability to be part of the shortest paths between all nodes in a network. This measure allows for the identification of key bridges between nodes. In terms of a spatial layout, betweenness centrality helps to understand a node's significance in its connectivity with other nodes. A high centrality measure indicates that the node is part of many shortest routes, thus translating to increased movement and potential interactions. Based on each node's architectural program, e.g. the elevated garden spaces on Level 3, we can infer the effectiveness of such an area within the entire development. Questions such as, "Would we locate the garden space next to a node point which is central and easily accessible by all occupants of the building?" can thus be addressed.



**Figure 6(L):** Distance-Weighted Betweenness Centrality diagram of SUTD spatial network, visualized by Gephi

**Figure 7(R):** Distance-Weighted Load Centrality diagram, spatial visualization overlay by Rhino, grasshopper

Comparing and correlating the various centrality measures allows us to identify the significance of spaces regarding their function and location. It further allows us to identify the parameters for designing their size, co-location, and social spaces position within the larger development. Combined with the node attributes, we can further identify the factors influencing a space's effective use.

#### **2.4. Experimental Data Collection: Bi-Directional People Counters**

Our mobility mappings in the study consisted of tracking and recording pedestrian movements in public and common spaces in key collaborative zones on ground and elevated SUTD Campus levels. We recorded the frequency and intensity of actual use by employing bi-directional people counters with infrared sensors. People counters are a simple device that allows for measuring the volume and time of human flows. The devices were installed at key access points to the nodes identified during the architectural and spatial network analysis to collect inflow and outflow volumes during different times of the day. The collected data provided the total volume of users circulating through the selected spaces. The variations in space use volumes allowed for identifying space use patterns over the day and provided a measure of actual space use and performance.



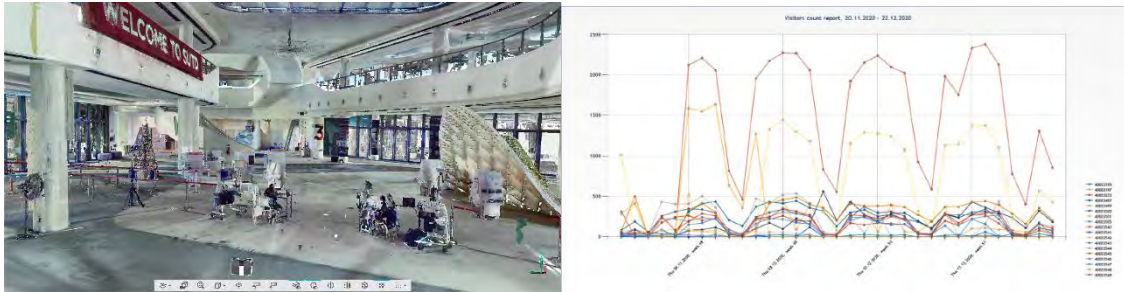


Figure 8(L): Point Cloud image of L1 Campus Centre, visualized by Faro SCENE software

Figure 9(R): Visitor Count Report, Sensmax people counter

### 3.0. RESULTS

#### 3.1. Correlation of Spatial Network Measures and Actual Usage

The following section presents our comparison between spatial network measures and actual space use in the campus's two selected zones. Zone 1 refers to the L1 Campus Center and L3 Sky Gardens directly above it. Zone 2 refers to the L1 Community Plaza, and the L3 and L5 Sky Bridges directly above it. [figure 3]

Table 1: Corresponding nodes on the ground and upper levels: network centrality measures, compared to movement volume, using a fraction of total

Zone	Location	network centrality measures*			fraction within each zone			movement volume per access point	
		degree	close-ness	betweenness	degree	close-ness	betweenness	Fraction within each zone	Weekly average volume per access point
1	L3 Sky Garden	0.0185	0.00816	0.131	0.385	0.499	0.576	0.057	494
	L1 Campus Centre	0.0296	0.00818	0.0967	0.615	0.501	0.424	0.943	8212
2	L5 Sky Bridge	0.0148	0.00940	0.143	0.286	0.346	0.399	0.122	1848
	L3 Sky Bridge	0.0185	0.00986	0.183	0.357	0.363	0.514	0.417	6295
	L1 Community Plaza	0.0185	0.00794	0.031	0.357	0.292	0.087	0.461	6969

\*where  $n$  is the number of nodes in graph  $G$ ; The degree centrality values are normalized by dividing by the maximum possible degree in a simple graph  $n-1$ . Closeness and betweenness centrality are weighted by distance. The closeness centrality is normalized to  $(n-1)/(|G|-1)$  in the connected part of graph containing the node; the betweenness values are normalized by  $2/((n-1)(n-2))$ .

#### 3.2. Discussion

Degree centrality: The best connected or influential nodes with the highest numbers of degrees in Zone 1 were the L1 Campus Center and in Zone 2 the L1 Community Plaza and L3 Sky Bridge.

Closeness centrality: All the nodes we selected for our study had similar closeness centrality values. They are located in relatively central and easily accessible areas that connect the various buildings. The result corroborates the architectural design intent and concept of central collaborative zones along the key circulation axes and results in spaces in both zones; the L1 Campus Center, the L1 Community Plaza, the L3 and L5 Sky Bridges and the L3 Sky Gardens are highly connected to the spatial clusters of the various buildings.

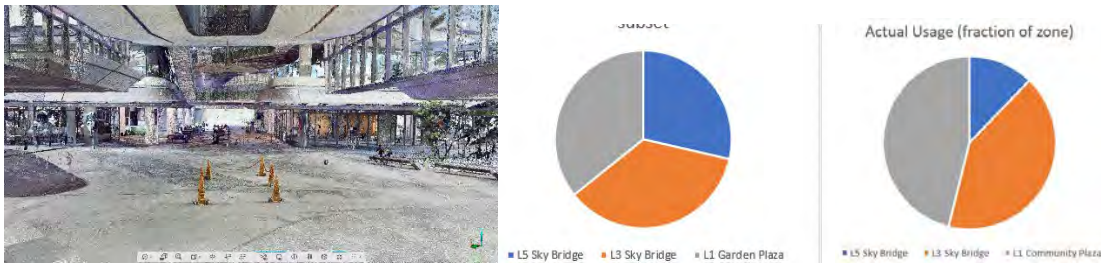


Betweenness centrality: As a measure of a node being central to shortest paths between all nodes, the results are significant in the discourse on vertically integrated buildings' effectiveness. They show elevated connections have the shortest paths to all other nodes because the centrally located vertical spaces are privileged as the shortest path between all the other levels.

Actual space use: [refer to results in *Table 1*] In Zone 1, the comparison of network measures to actual space use shows mixed results. The relative volume of movement appears to be heavily skewed towards the L1 Campus Center. The values indicate that the L3 Sky Garden was not used frequently as a bridge between the buildings. The Campus Center is located at the intersection of the Living and Learning Spines of the Campus. It connects Buildings 2 and 3 and includes the main University drop-off point and garden route to the hostels and sports facilities. We can therefore assume that most Campus users would pass through this node. However, we would like to note that due to COVID-19 safety measures, all visitors to the campus were required to register in the Campus Centre during the research period, which most likely skewed the movement volume.

In Zone 2, the high flow on the L3 Sky Bridge corresponds with the closeness and degree centrality we found [*Figure 11*]. The Ground Level presents the highest amount of traffic flow (of the zone subset). The presence of horizontal and vertical connectivity in the elevator and staircase cores improves the elevated connection's connectivity. We recorded substantial actual flow and connectivity on the L3 Sky Bridge and L1 Community Plaza. The data shows that they serve well as collaborative and social zones. The L1 Community Plaza anomaly that displays a low betweenness centrality in the spatial network is inconsistent with the actual flow that amounts to 46.1% of the total traffic in this subset. We believe that this is related to the presence of study tables in the L1 Community Plaza, which increases users' flow and the program's diversity that includes food and retail shops adjacent to the L1 Plaza. The L5 Sky Bridge network measures are proportionally lower, but the actual flow is also much lower. More significant seasonal variations may be related to seasonal reasons, such as exam periods. A more comprehensive study that considers more details, such as timing and study tables, may show better-defined spatiotemporal correlations.

Adding more programs on the L3 Sky Bridge may be warranted, given the correlation of its actual space use with centrality measures. The bridge's function as a connector between the buildings and its proximity to vertical circulation cores aligns with their design intent of 'circulation' and 'flow'.



**Figure 10:** Point Cloud capture of L1 Community plaza, visualized by Faro SCENE software

**Figure 11:** Pie chart of (L) spatial network measure of degree centrality (fraction of zone) vs (R) actual usage (fraction of zone), Zone 2

Given the design intentions of the architects, our research focused on circulation spaces. However, our research methodology can include other spaces as well and as such inform spatial design in general, e.g., the performance of networks can be improved through the inclusion of additional node attributes, such as visual connectivity or parameters correlated with socio-spatial qualities and macro- and micro-temporal flows can be considered as well.

### 3.3. Limitations

Our data collection in the larger SUTD Campus is still in progress when we are writing this paper. Once available, the data will allow for a finer granularity and a more detailed comparison of network measures with actual space use and evaluation of the development performance.

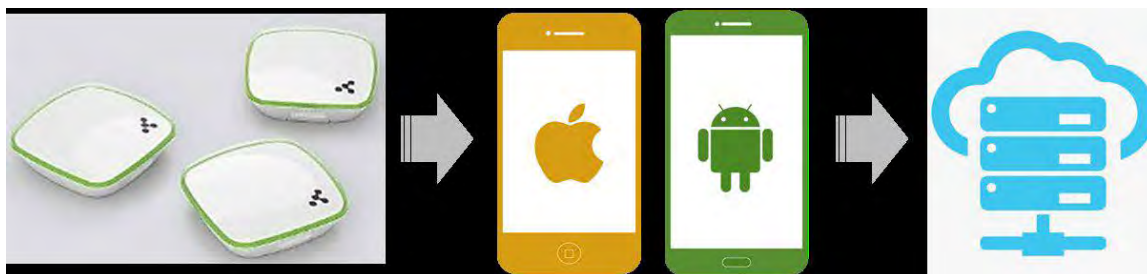
As this study was conducted during the COVID-19 pandemic, circulation on the Campus' upper levels was limited and only possible through the Campus Center, which increased actual space use measurements in the latter and other main circulation access points. The consideration of major events and local administrative policies that result in circulation and other space use restrictions would also be valuable to fully capture the performance parameters and suggest how they may affect the entire network's resilience.

Our study provides a snapshot of the performance of the SUTD Campus over four weeks. An extension of the data collection over a more extended period would capture seasonal activities and term breaks and, therefore, allow for a better understanding of longer-term space use patterns. A detailed hourly microflow study that would capture the micro-variations during workdays and weekends would provide finer granularity. We plan to use Machine Learning algorithms to arrive at such a finer granularity in the future.

Lastly, like mobile apps, including popular social media, already capture proprietary movement ostensibly used in activity pattern analysis, the adherence to ethical standards by corporations and governmental bodies for individual liberty and privacy is paramount to any tracking approach. Anonymization and opt-out options were, therefore, crucial in our study and had to be implemented.

### 3.4. Future Directions: Experimental Tracking with Smartphone App with BLE Beacons

As part of our more extensive research, we are currently developing a low-energy Bluetooth (BLE) tracking and localization method that will be used to track and localize selected study participants. These comprise frequent SUTD space users, including faculty, students, staff, and vendors. The Bluetooth localization consists of three components, (1) stationary low-energy Bluetooth beacons, (2) a mobile app, and (3) a cloud server uses a 'peer-to-environment' sensing system that involves the placement of stationary Bluetooth beacons in the study locations. The smartphone devices allow for the mobile user to receive the data sent by the beacons. The collected data contains information about the transmitting beacon such as unique ID, time, telemetry (temperature, etc.), and the transmitting distance (indicating the stationary beacon's reach from the mobile app). Smartphones constitute the peer component of the system. A custom app installed on smartphones running IOS or Android works in the background and scans for Bluetooth data from the BLE beacons. It stores relevant data temporarily and then transmits the information to the cloud server. The data collected from the participants' Bluetooth devices are plotted on the spatial network to map the participants' movement routines over a continuous period. The experimental data measures deduced from the spatial network analyses are then validated with the real-world data, with the correlations between the designed and actual space use providing the basis for the spatial layout's performance assessment.



**Figure 12:** Bluetooth localization and tracking consisting of low-energy Bluetooth beacons, mobile app and cloud server

Also, co-presence networks are discerned from the BLE-localized mobility patterns.

In Complexity Science, when two or more people are close to each other, they are considered to be in co-presence. Co-presence is a necessary but not sufficient condition for interactions. A co-presence network is a social network of friends and strangers that can analyze social relationships as dynamic processes. The participant users form the nodes and the time spent in each other's proximity constitute the edges. Co-presence networks are thus temporal, and their edges appear and disappear. Over time, a co-presence network emerges that displays strong and weak ties. Persistent encounters between users indicate homophily (strong ties), while brief and chance encounters indicate heterophily (weak ties). Stronger ties influence social behavior, while weaker ties complete the connectivity within the network. (Manivannan et al., 2018) When embedded into a building's spatial layout, the temporal co-presence network simulates user interactions patterns and their relative strength over time. The aggregated network can also highlight the connectivity of different social spaces that enable homophily and generate more opportunities for brief chance encounters. These insights can provide important information for the future planning and design of vertically integrated developments.

## CONCLUSION

Our study of the SUTD Campus shows that the Complexity Science-based analysis of vertically integrated buildings based on user-generated data can better understand their socio-spatial qualities and performance. The comparison of architectural design intent with quantitative spatial network analyses and actual on-site measurements can provide important insights regarding their spatial effectiveness. These inferences can become the basis for the future planning and design of such buildings, e.g. the location of important social focal points at locations that correlate with high degree centrality, elevated connections at node points with high closeness and between centrality measures, and the design

planning of the architectural program that supports the function of the nodes at these locations.

The further extended study of correlation of different network measures with the actual human flow and space use and comprehensive analysis that includes more temporal and co-presence patterns and factors would yield more in-depth insights into buildings' actual performance.

## ACKNOWLEDGEMENT

The research presented in this paper is part of the Urban Science and Design for Density thrust of the Cities program at SUTD.

## REFERENCES

- Barthélémy, Marc. 2011. "Spatial Networks." *Physics Reports Volume 499*, Issues 1-3.
- A. Barrat, M. Barthélemy, R. Pastor-Satorras, and A. Vespignani. 2004. "The architecture of complex weighted networks." *PNAS March 16, 2004* 101 (11) 3747-3752.
- Batty, Michael. "Complexity and emergency in city systems: Implications for urban planning." *Malaysian Journal of Environmental Management* 10, no. 1 (2009): 15-32.
- Kennedy C., Pincetl S. and Bunje P. 2011. "The Study of Urban Metabolism and Its Applications to Urban Planning and Design." *Environmental pollution* 159 (8-9), 1965-1973.
- Manivannan, Ajaykumar, Yow, W. Quin, Bouffanais, Roland and Barrat. Alain. 2018. "Are the different layers of a social network conveying the same information?" *EPJ Data Science* 7 (1), 34.
- Schröpfer, Thomas. 2017. "Singapore University of Technology and Design: Crossing Disciplines by Design." *Singapore Architect* 287: 76-86.
- Schroepfer, Thomas. 2020. *Dense+Green: Cities: Architecture as Urban Ecosystem*. Basel: Birkhäuser

## ENDNOTES

- Figure 1: Karen Cilento, "Singapore University of Technology and Design/ UNStudio + DP Architects," *Archdaily*, November 24, 2010, accessed April 30, 2015, <http://www.archdaily.com/91407>.
- Figures 2, 3, 4, 5: Ben van Berkel and Caroline Bos, *UNStudio Design Models: Architecture Urbanism Infrastructure*. London: Thames and Hudson, 2006: 10-23.
- Figures 6, 7, 8, 9, 10, 11: SUTD Advanced Architecture Laboratory and Applied Complexity Group.

# Developing Life Cycle Assessment (LCA) System Boundary Guidelines for Comparable City Evaluations

Hala Alfalih<sup>1</sup>, Tarek Rakha<sup>1</sup>

<sup>1</sup>Georgia Institute of Technology, Atlanta, GA

**ABSTRACT:** This paper will provide the basis for a standardized method to define the system boundary for urban-scale Life Cycle Assessment (LCA). Since urban areas are made up of different sized neighborhoods with different levels of development, various geographical locations and multiple systematic subdimensions (energy, quality of life, information, materials, utilities and governance, transport) we cannot apply the same framework to determine the system boundary for all of them. The proposed process is threefold: First, selecting multiple different urban regions. Second, determining what the urban region includes, from physical boundaries to systemic functions. Third, understanding which networks are directly and indirectly affected by the functions of a city, and hence being able to determine the physical then methodological definition of the system boundary. The results can then be compared and iterated to produce a more reliable framework for determining the system boundary. Therefore, providing more opportunities to compare assessment results from one city to another. Through the review of different papers, knowledge gaps and data categories have been identified to start defining the system boundary. This research provides an early first iteration of possible systems, groups of processes, flows, and life cycle stages in the form of a list to aid in developing a standard method in defining the system boundary of an urban region globally.

**KEYWORDS:** City, Life Cycle Assessment (LCA), Urban environmental assessment, Urban Metabolism

## INTRODUCTION

Global urbanization is continuously increasing. According to the United Nations more than half of the world's people are living in urban areas. This means that environmental burdens are increasing as well (United Nations 2018). This signifies the importance of assessing urban performance in relation to the environmental impact that cities have, both directly and indirectly. It is essential to find a method to quantify the environmental impacts of cities for sustainable urbanization (Goldstein, Birkved, et al., Quantification of urban metabolism through coupling with the life cycle assessment framework: concept development and case study 2013). Life Cycle Assessment (LCA) provides a method to quantify and assess the performance of cities holistically and comprehensively, which demonstrates these impacts (Mirabella, Allacker and Sala 2019). Currently, the ISO standards 14044 and 14040 provide a procedure set for handling the development of LCA which can be applied to complex systems such as cities (Alberti, et al. 2017). According to previous literature, LCA at the urban scale lacks data granularity and homogeneity. Information such as the system boundary definition (administrative, systematic, and geographical), reference flow (the number of cities which is equivalent to a city of one million inhabitants living with full prosperity in a given year), function (describes the performance characteristics of the system under study), and functional unit (a quantification of this performance for use as a reference unit) are still being researched and determined (Alberti, et al. 2017).

The goal of this research is to move towards creating comparable results between urban scale LCA, and the first step of this is to be able to define the goal and scope of the study. The objective is to define a procedural method for defining system boundary in urban scale LCA. This research will attempt to categorize data that can be used as a checklist of sorts to define the system boundary. The goal is that the categories can be applied to different urban regions around the world and provide a framework, not a rigid standard, that can be used as guidance to produce more accurate results. This can lead to a possible ranking system allowing us to compare indicators and target points of intervention in urban regions.

## 1.0. URBAN-SCALE SUSTAINABILITY ASSESSMENT METHODS

Sustainability assessments help provide a metric through which we can begin to relate urban regions to each other regarding economic, social, and environmental conditions. Of the most significant methods are Urban Metabolism (UM) and Life Cycle Assessment (LCA).

### 1.1. Urban Metabolism (UM)

The concept of Urban Metabolism (UM) has been used to analyze urban regions to provide insights on the environmental sustainability of these regions (Beloin-Saint-Pierre, et al. 2017). Restrepo and Morales-Pinzon define

UM as "a concept in which the city is analyzed using the biological notion referring to the internal processes by which living organisms maintain a continuous exchange of matter and energy with their environment to enable operation, growth, and reproduction" (Restrepo and Morales-Pinzón 2018). On the other hand, Kennedy, et al. define urban metabolism as the total of the technical and socio-economic processes that occur in cities, resulting in growth, production of energy, and elimination of waste (Kennedy, Cuddihy and Engel-Yan 2008). UM can be found in terms of energy equivalents, or broadly expressed in terms of the city's flows of water, materials, and nutrients as mass fluxes. The outputs of UM can be in the form of: Sustainability indicators, inputs to urban greenhouse accounting, dynamic mathematical models for policy analysis, and design tools. (Kennedy, Pincetl and Bunje 2011)

The major issues when using the UM model is the lack of data at the city-scale, lack of follow up and evaluation of the evolution of a city's UM, and difficulties in identifying cause-and-effect relationships for the metabolic flows. (Maranghi, et al. 2020) Beloin-Saint-Pierre, et al. review urban metabolism studies and identify seven different assessment tools (Beloin-Saint-Pierre, et al. 2017). (Table 1)

**Table 1: Inputs, outputs, and drawbacks of Urban assessment tools based on supplementary information provided by Beloin-Saint-Pierre, et al.**

Urban Assessment Tools	Input	Output	Drawbacks
Network Analysis	Process flows between components	Qualitative information about the relationships (assessment)	<ul style="list-style-type: none"> <li>• Few implementations</li> <li>• The link between environmental sustainability and relationships is very limited</li> </ul>
Input/Output	Links between components of a global structure (direct/indirect needs)	Different sectors impact on global sustainability	<ul style="list-style-type: none"> <li>• Defining system is difficult</li> <li>• Defining specific component in sector is impossible</li> </ul>
Flow Analysis	Substance, material, or energy flows	Flows entering and leaving the system (inner circulation can be included). Stock materials and energy	<ul style="list-style-type: none"> <li>• Lack of clear connection environmental impacts</li> </ul>
Energy Assessment	Network of components (model flows of energy)	Upstream energy needs (specific energy equivalents)	<ul style="list-style-type: none"> <li>• Lack of clear connection environmental impacts</li> </ul>
Footprint	<ul style="list-style-type: none"> <li>• Flows between components</li> <li>• Environmental effects of components</li> </ul>	Environmental impact per habitant (direct and indirect environmental effects on a particular indicator)	<ul style="list-style-type: none"> <li>• Lack of consideration for other impacts</li> </ul>
Life Cycle Assessment	Function of the system (process flow amounts and elementary flows.)	Environmental impact values	<ul style="list-style-type: none"> <li>• Complex and time consuming</li> <li>• Quality of data is hard to maintain</li> <li>• Determining system boundary is vague</li> </ul>

## 1.2. Life Cycle Assessment (LCA)

Cities are not static and have connections with the surrounding environment. Maranghi et al. define life cycle thinking as a systemic approach for comprehensively assessing sustainability based on critical information by integrating the environmental profile of a system with its socio-economic aspects (Maranghi, et al. 2020). LCA assesses the environmental impacts and their potential (and relates these to a functional unit such as per person and year) by studying different phases of a product at the simplest scale (Lundin and Morrison 2002, 147), (ISO 2006). The results of an LCA can help evaluate environmental sustainability and these results can help inform decision-makers. This method of analysis can be scaled up and applied to the scale of buildings and even further into urban regions because it is a multidimensional approach to quantifying the environmental impact of a city. It will help ensure that the scope of the study is encompassing the direct and indirect effects. LCA incorporates a life cycle thinking perspective which takes into account all the stages of life; from the extraction of raw materials phase to production to distribution or transport to use/occupation to finally the disposal or recycling phase. To assess the environmental impacts in such a holistic way, understanding the networks affecting every stage, directly and indirectly, is critical to producing accurate results. This

method of complex system thinking incorporated in LCA makes it suitable to scale up to the urban region. Including the networks involved in an urban region means thinking about the upstream and downstream flows of energies and materials between the geographical location and its surrounding environment. Through a review of non-LCA-based standards in the urban scale, Alberti, et al. have established that they are lacking in the following: a holistic point of view, a focus on various environmental impacts, a life cycle perspective, and the ability to compare results between different regions. (Alberti, et al. 2017)

Furthermore, LCA is lacking in the ability to produce data that can be compared across the board, especially when scaled up to the urban region. This is because of the difficulty in defining the goal and scope of a study, especially since it is significantly challenging to define the beginning and end of a system such as an urban region. There are a few definitions mentioned in the ISO 14044 and 14040 which can help provide more comparable results if guidelines are provided in terms of the scale. According to Alberti, Brodhag and Fullana-i-Palmer lifespan variations in LCA can be avoided by applying a "per year" consideration and maintaining the same number of inhabitants to compare city results later. (Alberti, Brodhag and Fullana-i-Palmer 2019).

LCA results can be communicated as Life Cycle Inventories (LCI), midpoint environmental indicators, endpoint indicators, or weighted impact scores (Goldstein, Birkved, et al., Quantification of urban metabolism through coupling with the life cycle assessment framework: concept development and case study 2013). These indicators can provide a good baseline for decision-makers to start making better-informed decisions regarding their cities. The LCA study can produce an "eco-indicator" which is a single figure in which each environmental problem is weighted in terms of its importance (Ferraó and Fernandez 2013).

## **2.0 ISO STANDARDS (14044, 14040)**

### **2.1. System Boundary**

The International Organization for Standardization (ISO) is an international body that sets standards agreed upon by experts that cover a large range of activities. ISO standards help us develop results that can be compared to each other and benchmarked so we can maintain a certain level of quality and ensure the information being produced is up to a certain standard. We need these standards for quality assurance and result standardization.

Since LCA is such a data-intensive and all-encompassing method of assessment, a guideline or framework has been established by ISO to help maintain the quality of the data being produced at a global level. However, these guidelines are written to assess products or services with significantly manageable data and scopes limiting our ability to perform assessments at the scale of a building or even urban regions. The ISO 14044 Environmental Management – Life Cycle Assessment – Requirements and Guidelines and ISO 14040 Environmental Management – Life Cycle Assessment – Principles and Framework (2006) are the international standards that will be referred to in this research. The ISO standards first introduce the four phases of a LCA study: 1) The goal and scope definition. 2) The inventory analysis phase (Life Cycle Inventory). 3) The impact assessment phase (LCIA). 4) The interpretation phase.

When defining the scope, there are general parameters that must be considered and applied. These include the functions (the systems), the functional unit, the reference flow, and the system boundary. The function includes the performance characteristics of a study, and the functional unit will provide a reference for standardization in some form or another and with both of these first defined, the reference flow can then be determined. The system boundary and the level of detail will depend on the subject of the study (ISO 14040 2006). The objective of this paper is to introduce a procedure to help define the system boundary which can be applicable regardless of the geography, level of development, or networks and subnetworks. Comparisons between systems shall be made based on the same function, quantified by the same functional unit in the same form of reference flows (quantity per specific time) (ISO 14044 2006). Environmental impacts for different scenarios are then compared with this functional unit (Beloin-Saint-Pierre, et al. 2017). According to ISO 14044 and 14040, the system boundary determines which unit processes shall be included within the LCA. It should be consistent with the goal of the study (ISO 14044 2006). Determining the criteria by which the system boundary is defined is difficult because defining the beginning and end of an urban region is relative to the purpose of the study. Through some case studies, we can begin to see a pattern forming regarding the approach taken to define the system boundary. Separating the data into a structure not only helps understand the data better, but also can help provide a more detailed and organized LCA with more accurate results. Breaking up the network flows can help give results that can identify specific parts of the system that may be performing better or worse than others. Separating the system into phases can help us better narrow down which part of the system needs more assessment, so this method can be less time-consuming in the beginning. Considering the different scales of the boundary can also help us do this but we risk isolating some of the networks from others possibly giving less accurate results.



### 3.0 THE KNOWLEDGE GAP

A literature review has been performed to better understand the LCA and the method of conducting a reliable LCA at the scale of an urban region which can provide results that help compare urban regions globally to better design for sustainable cities. According to the ISO standards 14044 and 14040, the first step of any LCA is defining the goal and scope of the study. Within this scope, the system boundary is needed to be determined to better understand the limits of the study and to collect more accurate data. The problem, however, is that previous research has not determined a method to appropriately determine the system's boundary at the scale of a city. There is little to no research that can be used to create a guideline or a framework for determining system boundary that can be applied to more than one study.

In table 2, the left side is a list of the literature which has been considered to be significant to this research. The top shows different gaps in the knowledge of the field of urban LCA. When a specific topic is identified as needing further research in the literature, the table shows a circle (red or green) corresponding to the paper which has mentioned it. For example, Mirabella, Allacker and Sala 2019 identify a gap in defining the goal and scope. The topic identified to need the most research will be the column with the largest number of circles. In this case it is “defining goal and scope (function, functional unit, reference flow, system boundary)” and the circles are red to signify the importance of the findings.

	DEFINING GOAL AND SCOPE (FUNCTION, FUNCTIONAL UNIT, REFERENCE FLOW, SYSTEM BOUNDARY)	NETWORK RELATIONSHIPS (CROSS-BOUNDARY)	DATA GRANULARITY, RELIABILITY, AND HOMOGENEITY	STANDARDIZATION AND COMPARABILITY	DEFINING A CITY	MORE APPLICATIONS/STUDIES	HOLISTIC APPROACH
(MIRABELLA, ALLACKER AND SALA 2019)	●	●	●		●	●	●
ALBERTI, ET AL. 2017	●	●		●	●		
(MARANGHI, ET AL. 2020)	●	●	●				●
(ALBERTI, BRODHAG AND FULLANA-I-PALMER 2019)	●			●			
(BLENGINI AND DI CARLO 2010)	●						
(E. LOISEAU, ET AL. 2013)	●						
(LUNDIN AND MORRISON 2002)	●						
(ULGIATI, ET AL. 2011)	●						
(LOISEAU, ET AL. 2014)		●					
(BELOIN-SAINT-PIERRE, ET AL. 2017)		●					
(GOLDSTEIN, BIRKVED, ET AL. 2013)		●	●			●	

Figure 1 - Knowledge gaps according to research

## 4.0 RESEARCH METHODS

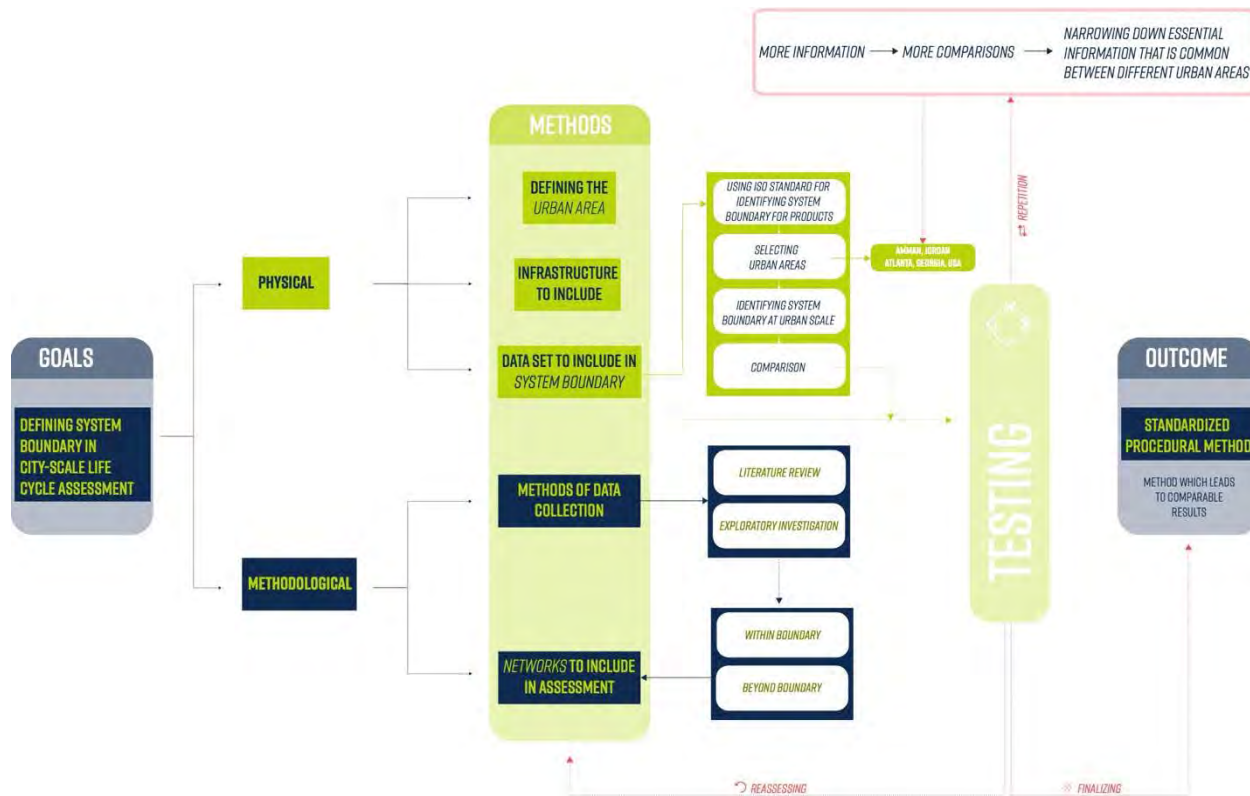


Figure 2: Research Methods

Through an understanding of the networks (both direct and indirect), the geographical boundary, the data availability and accuracy, and the scale the categories can be cross-referenced and related to each other. The goal is to investigate which systems are the most important to include in the definition of the system boundary in the first phase of the LCA at the urban scale.

The first part of the research attempts to scale up the guidelines that define a system boundary. The second is a process of data collection, filtering, and repeating for different urban regions which extend beyond the scope of this paper. The intention is to continue collecting data from different urban regions compiling a checklist or guidelines for different data. This data can later be categorized into different groups according to the urban region. With the process of repetition, this data can become a more accurate and reliable resource to guide future city planners in defining the system boundary for cities all over the world.

### 4.2. Framework

According to ISO 14040, there are different stages, processes, and flows that should be taken into consideration when conducting an LCA. These are represented in Table 3. Adapting this list can help us understand better LCA at the urban scale. The initial system boundary can be refined as we begin to see the results of the LCA and do more research (ISO 14040 2006). This is an early list of systems, groups of processes, flows, and life cycle stages to help determine the system boundary of an urban region. This is not an extensive list and will develop to incorporate all levels of detail and scale in future research. The information has been collected from the System of Environmental-Economic Accounting (SEEA) (United Nations 2014), Sustainable Urban Metabolism (Ferrao and Fernandez 2013) as well (Mirabella, Allacker, and Sala 2019) and (Lundin and Morrison 2002) then adapted for the research.

**Table 2: Life Cycle Stages at the product, building, and urban scale**

	Product Scale Stages (ISO 14040 2006)	Building Stages	Scale	Urban Scale Stages
Stage 01	Acquisition of raw materials	Embodied (product)	Carbon	Domestic extraction of resources, imports of raw materials and products
Stage 02	Inputs and outputs in the main manufacturing/processing sequence	Construction		Energy and material inputs and outputs
Stage 03	Distribution/Transportation	Transportation		Transportation
Stage 04	Production and use of fuels., electricity, and heat	-		Production/Outputs
Stage 05	Use and maintenance of products	Occupancy and Operation	and	Occupation/Consumption
Stage 06	Disposal of process wastes and products	End of life		-
Stage 07	Recovery of used products	Recycle/reuse/disposal		Waste Management
Stage 08	Manufacture, maintenance, and decommissioning of capital equipment			Exports
Stage 09	Addition operations	-		Additional operations

#### Systems

- Transportation systems – private vs public (e.g., energy and carbon footprint, GHG emissions, energy consumption, CO<sub>2</sub> emissions, and criteria pollutant emissions such as CO, VOC, SO<sub>x</sub>, NO<sub>x</sub>, and PM<sub>2.5</sub>)
- Waste systems: management and treatment
- Water systems: water and wastewater
- Energy extraction systems
- Infrastructure systems
- Energy system: heating cooling, electricity use, and mobility

#### Groups of Processes

- Built environment: buildings and construction
- Agriculture
- Consumption patterns: GHG emissions (one citizen per year). Food, accommodation, energy use, road transport, air travel

#### Flows

- Material
- Energy

#### Life Cycle Stages

- Raw materials and products: extraction of resources, import of raw materials and products
- Energy and material inputs and outputs (e.g., Direct Material Input DMI – acquisition of raw materials, Total Material Requirements TMR, Hidden Flows HF)
- Transportation
- Production/Outputs (e.g., Domestic Processed Output DPO, Domestic Material Output DMO, Total Domestic Output TDO, Total Material Output TMO)
- Occupation/Consumption (e.g., Domestic Material Consumption DMC – occupation, Total Material Consumption TMC)
- Waste management
- Exports/Impacts
- Additional operations

## 5.0 RESULTS

Data categories have been identified to start defining the system boundary. They are grouped into systems: 1) Transportation systems 2) Waste systems 3) Water systems 4) Energy extraction systems 5) Infrastructure systems, groups of processes: 1) Built environment 2) Agriculture 3) Consumption patterns, flows: 1) material 2) energy and life cycle stages: 1) raw materials and products 2) Energy and material inputs and outputs 3) transportation 4) production/outputs 5) occupation/consumption 6) waste management 7) exports/impacts 8) additional operations.

## 6.0 DISCUSSION

The first step to understanding the most important systems in a city or urban region is to determine geographical context and the size of the area to be assessed. This is simply numbers determining things like population size, area of the region, legal boundaries. After determining these boundary types (quantitative) we can look at more qualitative boundaries. Listing the systems which are important to the study is very important. Understanding what indicators are the most significant for us will provide us with this iterative feedback loop to constantly alter the system's boundary by adding more systems that are important or reducing the number of systems because they are insignificant to the result. We can determine some significant systems first: transportation networks, water, waste, energy flows, material flows, building environment. After this, we can start collecting the data from each of these systems. Transportation: energy and carbon footprint, CO<sub>2</sub> emissions, GHG emissions, energy consumption, pollutants, etc. and do the same for all the other systems, then perform the LCA.

Drawing a process flow diagram can be a very helpful first step in determining the system boundary. We do this by first identifying the unit processes, then determining the relationships between them, then describing each unit process through a definition of the beginning, the nature of transformations that occur, and the end in terms of the final products. This process is based on the proposed method in the ISO 14044 standards (ISO 2006, 8). Making a process flow diagram for each of these systems can help us determine which information needs to be collected and ensure that we are being specific. Then we can determine the internal energy and material flows between all the systems to give us the sustainability indicators in any urban region. Using the diagram can help us eliminate any systems that will not be included in this flow of energies and materials, helping us focus on the specific data which needs to be collected and producing more accurate results. This helps us save time and money. Moreover, the ISO 14044 standards have recommended three criteria to help determine which data is collected for the system boundary is necessary and which data can be disregarded called "cut off criteria". These criteria can help narrow down not only the data collected but also the results produced. They are: 1) Mass 2) Energy and 3) Environmental significance

## CONCLUSION

While more people move to cities, the burdens that urban regions have on the environment are also increasing. To counteract these burdens, we must start providing the decision-makers with reliable and representative data so that we can have a more environmentally responsible response in the design and policies of our cities. While LCA can only help provide indicators that can tell us how different urban regions are impacting the environment, this becomes a very important starting point to encourage the decision-makers to conduct more detailed analyses that can lead to targeted design interventions overall enhancing the environmental performance of our urban regions.

LCA provides an opportunity to holistically understand how urban areas are performing and to draw attention to specific environmental indicators. Previous research work in the field of LCA at the urban scale did not define a procedure for identifying the "system boundary" as part of the goal and scope of conducting an LCA based on ISO standards or obtaining more accurate and detailed data. This research will provide an early general procedural framework to define the system boundary for urban-scale LCA through an analysis of the ISO 14044 standards. This understanding of the standards can allow us to interpret the definition of the goal and scope phase through an upscaling approach. While this research is not collecting the data and performing an urban scale LCA, it is however attempting to define the system boundary in these types of LCA's and this distinction is important.

Previous literature has defined methods for identifying the function, functional unit, and reference flow but the system boundary has been a topic too broad to specify. This research has provided a very early first iteration of possible systems, groups of processes, flows, and life cycle stages in the form of a list to aid in developing a standard method in defining the system boundary of an urban region globally. While there are still issues of data reliability and accuracy to consider, the list of data is the first step in providing stronger results in these types of assessments. Future research should begin to apply this guideline of defining the system boundary in different urban regions and collecting data from these assessments. Through the application, we can begin to increase or decrease the data included within the boundary of the assessment and we can begin to understand which data to collect for more targeted outputs.

## REFERENCES

- Alberti, Jaume, Alejandra Balaguera, Christian Brodhag, and Pere Fullana-i-Palmer. 2017. "Towards lifecycle sustainability assessment of cities. A review of background knowledge." Edited by D. Barcelo. *Science of the Total Environment* (Elsevier) 609: 1049-1062.
- Alberti, Jaume, Christian Brodhag, and Pere Fullana-i-Palmer. 2019. "First steps in life cycle assessments of cities with a sustainability perspective: A proposal for goal, function, functional unit, and reference flow." *Science of the Total Environment* 1516-1527.
- Alnsour, Jamal Ahmad. 2016. "Managing urban growth in the city of Amman, Jordan." *Cities* 93-99.

- Beloin-Saint-Pierre, Didier , Benedetto Rugani, Lasvaux, Mailhac, Emil Popovici, Galdric Sibiude, Enrico Benetto, and Nicoleta Schiopu. 2017. "A review of urban metabolism studies to identify key methodological choices for future harmonization and implementation." *Journal of Cleaner Production* 163: s223-s240.
- Ferrao, Paulo, and John E. Fernandez. 2013. *Sustainable Urban Metabolism*. Sabon: The MIT Press.
- Goldstein, Benjamin, Morten Birkved, Maj-Britt Quitzau, and Michael Hauschild. 2013. "Quantification of urban metabolism through coupling with the life cycle assessment framework: concept development and case study." *ENVIRONMENTAL RESEARCH LETTERS*.
- Goldstein, Benjamin, Morten Birkved, Maj-Britt Quitzau, and Michael Hauschild. 2013. "Quantification of urban metabolism through coupling with the life cycle assessment framework: concept development and case study." *Environmental Research Letters* 8 (3): 035024.
- ISO. 2006. "ISO 14040." *ISO 14040:2006*. 07 01. <https://www.iso.org/standard/38498.html>.
- . 2006. "ISO 14044." *ISO 14044:2006*. 07 01. <https://www.iso.org/standard/38498.html>.
- Kennedy, C., S. Pincetl, and P. Bunje. 2011. "The study of urban metabolism and its applications to urban planning and design." *Environmental Pollution* 1965-1973.
- Kennedy, Christopher, John Cuddihy, and Joshua Engel-Yan. 2008. "The Changing Metabolism of Cities." *Journal of Industrial Ecology* 43-59.
- Loiseau, Eléonore, Philippe Roux, Guillaume Junqua, Pierre Maurel, and Véronique Bellon-Maurel. 2013. "Adapting the LCA framework to environmental assessment in land planning." *Environmental Lifecycle and Sustainability Assessment* 1533-1548.
- Loiseau, Philippe Roux, Guillaume Junqua, Pierre Maurel, and Bellon-Maurel. 2014. "Implementation of an adapted LCA framework to the environmental assessment of a territory: important learning points from a French Mediterranean case study." *Journal of Cleaner Production* 17-29.
- Lundin, Margareta, and Gregory M. Morrison. 2002. "A life cycle assessment based procedure for the development of environmental sustainability indicators for urban water systems." *Urban Water* 4 145-152.
- Maranghi, Simone, Maria Laura Parisi, Angelo Facchini, Alessandro Rubino, Olga Korsdas, and Riccardo Basosi. 2020. "Integrating urban metabolism and life cycle assessment to analyse urban sustainability." *Ecological Indicators* (Elsevier) 112.
- Mirabella, Nadia, Karen Allacker, and Serenella Sala. 2019. "Current trends and limitations of life cycle assessment applied to the urban scale: critical analysis and review of selected literature." *The International Journal of*
- Restrepo, Juan Céspedes, and Tito Morales-Pinzón. 2018. "Urban metabolism and sustainability: Precedents, genesis and research perspectives." *Resources, Conservation & Recycling* 216-224.
- Ulgiate, S., M. Ascione, S. Bargigli, F. Cherubini, P.P. Franzese, M. Raugei, S. Viglia, and A. Zucaro. 2011. "Material, energy and environmental performance of technological and social systems under a Life Cycle Assessment perspective." *Ecological Modelling* 176-189.
- United Nations. 2014. *System of Environmental- Economic Accounting 2012— Central Framework*. Framework Document, New York: United Nations.
- United Nations. 2018. *World Urbanization Prospects: The 2018 Revision*. The United Nations.

# Urban Heat Island Phenomenon: A Review and Comparison of Assessment Methodologies

Aysem Berrin Cakmakli<sup>1</sup>, Hazem Rashed-Ali<sup>2</sup>

<sup>1</sup>Middle East Technical University, Turkey

<sup>2</sup>The University of Texas at San Antonio, TX

**ABSTRACT:** The temperature difference between densely built-up city areas and surrounding suburban and rural ones is defined as The Urban Heat Island (UHI) phenomenon. In the literature, there are two main classifications for factors influencing this phenomenon including spatial factors, e.g. features of landform surfaces and surface characteristics, and temporal ones, linked to yearly, seasonal, diurnal, and nocturnal air and surface temperatures. This paper presents an overview and critical analysis of existing literature regarding the Urban heat Island (UHI) phenomenon. The paper also addresses existing approaches for measuring the urban heat island intensity (UHII). Several methodologies for modelling UHI intensities at the building, city, and regional scales are then presented. The paper concludes with an analysis and categorization of the characteristics of the Urban Heat Island Phenomenon (UHI) across four different climate regions and addresses spatial and temporal factors used to assess the environmental and social impacts of the phenomenon on urban planning in these different climatic regions, and how some of these factors can be used as design tools to compare and evaluate different arrangements, renovations and policy making strategies.

**KEYWORDS:** Urban heat island, urban heat island intensity, sky view factor, vulnerability index

## INTRODUCTION

In the 21st century, climate change is considered as one of the key challenges facing communities across the world and causing significant and increasing worldwide concerns because of its possible effect on the prosperity of the world's occupants through the effects of temperature increases, capricious precipitation trends, and extreme weather events (World Health Organization, 2018). The impact of human interventions, adjusted to the ecological, social and cultural cycles, combined with natural and anthropogenic factors affect nearly half of the earth's surface and its climate (Milligan, 2010). Rapid urbanization, which is caused by unpredictable high levels of migration from rural to urban areas, resulted in transforming substantial amounts of green areas into gray field development, and the balance between these two types became an essential urban planning and urban design issue especially in high-density urban areas. These urban migration patterns have resulted in a growth of approximately 48% in the worldwide population of urban areas. This population is expected to reach five billion by 2030 (World Urbanization Prospectus, 2018). Because of this, housing, commercial and transportation infrastructures have been dominating urban developments frequently at the expense of the development of a continuous and integrated green infrastructure in cities. The critical contribution of having such a green infrastructure to urban climate strategies become undoubtedly evident when the recent investments in housing and transportation are considered. Because of all these parameters, generating more sustainable urban communities, with low or no negative ecological impacts, has emerged as a critical agenda item for all world communities (Kumar *et al.*, 2015).

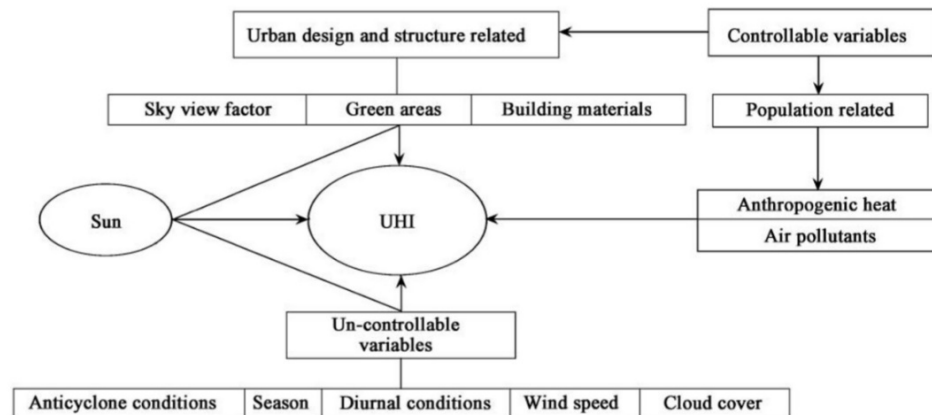
The waste heat scattered by humans because of anthropogenic heat released from the combustion of fossil fuels combined with the heat emitted from solar radiation entrapped by urban structures cause an increase in surface and air temperatures in densely built-up urban regions when compared to surrounding suburban and rural areas. The observed temperature difference between rural areas and dense urban areas due to this increase in urbanization is known as the Urban Heat Island phenomenon (UHI). Factors affecting the urban heat island phenomenon can be classified in two main groups, as depicted in Figure 1: 1) spatial, controllable, factors such as the characteristics of the urban environment and 2) temporal, uncontrollable, ones like climatic factors, meteorological features, and geographical circumstances.

The UHI Phenomenon has had global impacts and has been extensively documented and investigated in many cities around the world. Most prominently, the U.S. Environmental Protection Agency (US EPA) found that the annual mean air temperature for urban areas with populations of one million or more can be 1.8 to 5.4°F (1 to 3°C) warmer than its surrounding suburban and exurban areas. However, at nights a temperature difference of up to 21.6°F (12°C) can be observed according to the geographical characteristics of the area (EPA, 2016). The magnitude of this difference mostly depends on the release of the heat that is absorbed by built-up surfaces such as rooftops and pavement during daytime.



Factors affecting the magnitude of the UHI phenomenon include:

- 1) Geographic latitude,
- 2) Changing of the land characteristics from evaporating surfaces, green areas and water bodies to surfaces that have higher thermal inertias and impervious ones, decreasing evapotranspiration, (Hien and Jusuf, 2009)
- 3) Canyon geometry and thermodynamic characteristics of the urban fabric,
- 4) Anthropogenic heat sources, including waste heat (Oke, 1982).



**Figure 1.** Generation of Urban Heat Island. Source: (Errel, Pearlmutter and Williamson, 2012)

The wellbeing of humans is also affected by the magnitude of the UHI phenomenon. High levels of UHI can cause serious health impacts such as heat strokes and cardiovascular problems that cause an increase in mortality rate especially among at-risk populations such as the elderly and low-income communities which do not have access to effective cooling systems. The literature shows that the annual mean number of weather-related deaths from 1975 to 2010 was approximately 1,300 deaths. This annual number, however, is estimated to reach 20,000 by 2100 due to the increasing magnitude and intensity of UHI (IPCC, 2014). In light of these studies, it can be clearly seen that this growing global problem will have severe negative consequences for both human beings and the environment. In order to mitigate these negative impacts, essential precautions and strategies should be considered. This paper focuses on an overview of current approaches and methodologies used in measuring and modeling UHI intensities. Given the role played by local climate both in affecting the intensity and characteristics of UHI in different locations as well as determining the best mitigation strategies for those location, the paper will provide an analysis of the impact of climate on UHI.

## 1.0. DEFINING THE URBAN HEAT ISLAND (UHI) PHENOMENON

As previously discussed, the UHI phenomenon occurs due to air and surface temperature variations between high-density metropolitan areas and their surrounding suburban, exurban and rural areas. The phenomenon was first observed and documented by Luke Howard in 1833 while analyzing the effect of urbanization on climate in London (Stewart, 2011). Howard discovered that the massive structures in cities absorb solar radiation and waste heat that comes from the dissipated energy used by humans during day and emit into the atmosphere at night. It is now generally accepted that UHI is caused by a collection of factors: 1) the complex massive urban structures act as obstacles that reduce the sky view factor (see section 2.1), 2) these structures also store and re-emit huge quantities of solar radiations into the atmosphere at lower frequencies (infra-red), and 3) anthropogenic heat is also generated from vehicles, air conditioning systems, and power plants. The waste heat that comes from the dissipated energy used by humans and the heat from incoming solar radiation can also be trapped by the physical geography and high-density built environment of a metropolitan region. Conversely, under certain circumstances, a phenomenon called the Urban Cool Islands (UCI) can occur which has the opposite impact of UHI. Landscape infrastructure and soil mineral composition, along with certain climatic considerations that affect thermal inertia, are the main parameter that can cause this issue (Errel, et al. 2012).

The UHI phenomenon can be classified according to its observed location. When observed at the surface level, UHI is typically described as Surface Heat Islands (SHI). Conversely, when observed in the atmosphere, it is typically known as Atmospheric Heat Islands (AHI). Atmospheric heat islands are subsequently divided into two major categories: canopy-layer heat island, typically observed in the city, and boundary-layer heat island, typically observed above the city. The SHI, which typically occurs in urban districts dominated by impervious surfaces and enclosed by vegetated

and much more pervious rural areas, is stronger during the daytime than at night. The resultant UHI intensity, which is attributable to the variations of surface temperatures between urban and rural regions, can be identified by remote sensors, thermal visual imaging, and site analysis/field measurements. The canopy layer heat island, which is typically observed in the atmosphere closest to the surface of buildings in cities up to the average building height or mean roof height, is the reverse of SHI and is mostly insensible during the daytime. The boundary-layer heat island acts as a blanket one kilometer or more in thickness above the city during daytime, and hundreds of meters in thickness at night. This boundary-layer heat island is more directly affected by wind patterns. Finally, “hot spots” formed by shifts in diurnal and seasonal cycles under specified climatic issues and land-use transformations can be described as “urban heat island archipelago” (Errel et al., 2012; Unwin, 1980)

The increase or decrease of temperature can be affected by variation of urban geometry, wind speed and direction, form of radiation received, shortwave, and released heat, long waves, and shadow patterns (Stewart, 2011). There is also a correlation between the magnitude of the population of a certain area and urban heat island intensity in that area. Larger populations can impact UHI directly by increasing anthropogenic heat generation, and indirectly through increasing pressure on the environment due to the infrastructure of the city, land and construction expansion and urban services (Akbari and Kolokotsa, 2016).

## 2.0. UHI INTENSITY AND ITS EVALUATION SYSTEMS

*The Urban Heat Island Intensity (UHII)* correlates with the probable risks associated with UHI. UHII is defined as the difference in surface or air temperatures between the city and its surrounding suburban and rural areas. UHII is measured by the following formula:  $\Delta T_{u-r} = T_u - T_r$ , where  $\Delta T_{u-r}$  is UHII,  $T_u$  is urban (surface or air) temperature and  $T_r$  (corresponding surface or air) rural temperature (Martin-Vide, Sarricolea and Moreno-Garcia, 2015). UHI Intensity can be evaluated by using a number of methodologies including remote sensing or field measurements. Three different methodologies are discussed here: the first one is directly related with measuring UHII, while the others are used both to measure UHII as well as being used as design tools to compare and evaluate different policy making strategies and develop planning scenarios.

### 2.1. Sky View Factor (SVF)

The Sky View Factor (SVF) represents “the area ratio of visible sky in a hemispheric photograph in a certain district” geometrically and ranges from 0 to 1 (Zhang *et al.*, 2019). Thermal properties of environments are evaluated by using this indicator that shows the heat exchange ratio occurring as a result of the geometry and compactness of structures in urban areas and their peripheries. An SVF value of 1 represents no obstacles in the sky; whereas an SVF value of 0 represented a totally blocked sky. Even though the correlation between SVF and temperature is directly proportional for rural regions, in urban districts it is inversely correlated. For example, in dense urban environments, a low SVF means more obstructed sky and correlates with higher temperature increases. Conversely, in the countryside a low SVF, which is caused by storage capacity, effect of shading and evaporative cooling of greenery, especially big trees, causes low increases in temperature (Dirksen *et al.*, 2019). For this indicator, fish-eye photos or high-resolution 3D building models with airflow and temperature simulations and necessary meteorological data are typically used.

### 2.2. Vulnerability Index

UHI and climate change effects vary according to regional environmental, socio-economic, and sociodemographic considerations. The vulnerability index purposes to assess the risk level of the heat vulnerability of a specific community and its causes and effects at local scales. The vulnerability context has two perspectives; one is natural and defined as “a function of the character, magnitude and rate of climate variation to which a system is exposed, its sensitivity and its adaptive capacity” and the other one is social and is defined as “[the] degree to which a system is susceptible to injury, damage or harm” (IPCC, 2014). Mapping the vulnerability index of a certain area typically involves a GIS-based spatial information system, typically based on remote sensing, combined by the use principal component analysis (PCA) to statistically evaluate the combined impact of several variables. Statistical PCA models are used with different overlapping exposures to extreme heat combined with the characteristics of the region such as sociodemographic (ethnicity, age, language, education and economic level, population density) and land cover characteristics. These integrated models. These models are used to form a suitable pattern for that site and manage specific policies for increasing resilience to climate risks at the urban planning scale (Nayak *et al.*, 2018).

### 2.3. Biotope/Area Factor

The biotope/area factor (BAF) is used to describe land cover characteristics and then arrange necessary landscape articulations by designating the ratio of ecologically effective areas to that of the entire site. The BAF equation is as follows:

$$\text{BAF} = \text{ecologically effective areas} / \text{total land area (ranges from 0 to 1)} \text{ (Becker, 1990).}$$

While determining the BAF, the ecological characteristics and green and gray infrastructure of the regions, as well as the percentage and type of soil sealing parts should be determined. The percentages of different functions and usages, ecological characteristics and surface coverings and occupancy are measured through the site occupancy index.

Roofs and windowless external walls are also important parameters that are considered. Several objectives can be identified as optimum BAF targets in order to result in improved site ecological conditions. These include:

- 1) 'high evapotranspiration efficiency'; the increase of humidity and cooling effects
- 2) 'high capacity for binding dust'; accumulating dust on the leaves to reduce air pollution.
- 3) 'infiltration ability and storage of rainwater'; increasing the use of gray, black and rainwater and refilling groundwater capacity of surfaces.
- 4) 'conserving the filtering, buffering and transforming capacity of soil'.
- 5) 'availability as a habitat for plants and animals'; (Huang *et al.*, 2015).

### 3.0. UHI MODELLING METHODOLOGIES

The accurate classification of urban and rural sites is one of the main cornerstones of UHI studies. In order to generate a typical pattern of climatological analysis of regions (at either the local or city scale), both physical and socio-economic factors should be considered. However, urban districts have intricate and tremendously complex characteristics. Therefore, producing a typical analysis template can be difficult due to their dissimilar physical and socio-economic factors, form and land usage. The classification of regions to urban, metropolitan, or rural; depends on their actual configuration, surface characteristics and periphery environment. In the literature, Oke was one of the first to work on the classification of the regions due to their physical form, geography, landform and climatic characteristics (Stewart and Oke, 2012). In this work, he developed a "basic and conventional" characterization that incorporates all homogenous meteorological instruments of metropolitan climate districts. He found that the impacts of the vegetation and building characteristics are also important parameters while talking about site classification. Urban geometry, street configuration and construction materials were also included as variables in this classification. As seen in Figure 2, Oke's classification includes 17 standard classes: ten in the Built Series, and seven in the Land Cover Series. The classification entirely depends on the parameters related to the physical characteristics of urban structures (buildings/ street/ green zone geometry), land cover (permeability rate of the surface), urban fabric (thermal characteristics of construction/ environmental materials), and metabolism (anthropogenic heat fluctuation).

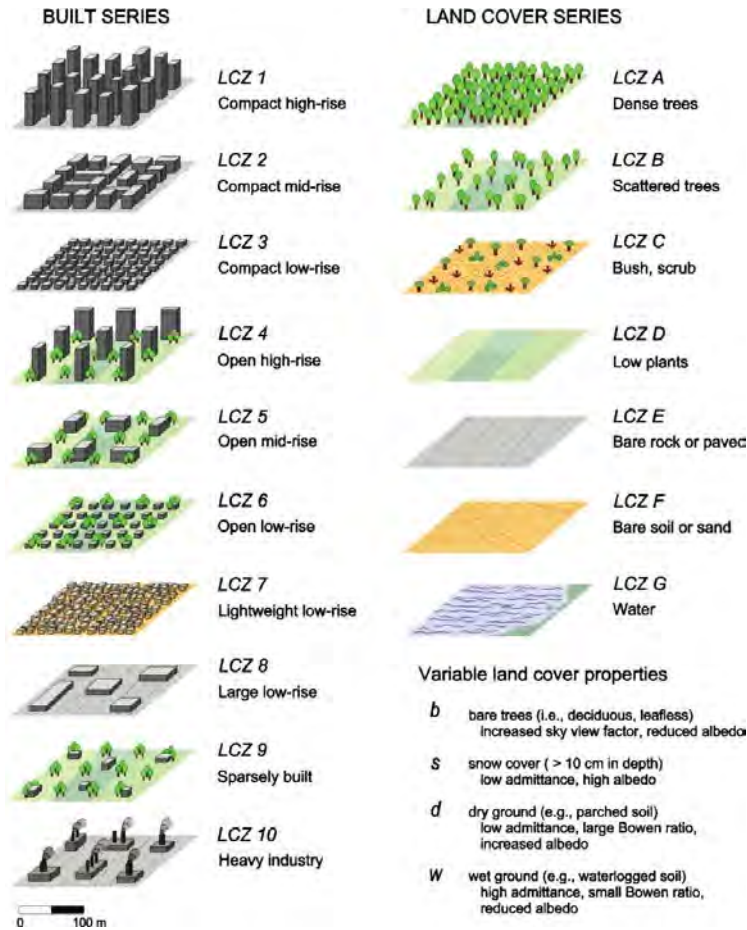
UHI models and assessment methodologies vary according to the scale they are intending to assess. These models vary from building-scale to urban scale according to the aim of the studies and measurement altitudes (Zhang *et al.*, 2009). Typically, these models can be classified into three categories: building-scale models, city-scale models, and regional climate models. The following provides a brief description of each.

#### 3.1. Building-Scale UHI Models

In these models, the main elements are buildings and their energy performances. Input data and modeling parameters for these models include building enclosures, periphery characteristics, envelope layers, their components and materials. These models also consider the surface temperatures of buildings as the main parameter used to describe the Surface UHI (SUHI). In order to define SUHI, the surface temperature differences between urban and rural districts should be measured. This typically relies on remote sensing and satellite images, which can provide high-resolution and high spatial coverage. These micro-scale UHI models can evaluate both the conditions of buildings as well as the interactions between those buildings and their environment. Canopy UHI, which is commonly projected at an elevation going from the ground to the rooftop, can be also assessed by using these scaled models (Voogt, 2007). In these models, the wind flow direction is analyzed using computational fluid dynamics (CFD) simulations, which utilizes weather station climate data to show the interactions of building orientation, street canyon ratio and surface cover characteristics with airflow patterns. Micro-scale Canopy UHI models, including CFD models, can typically cover small geographic areas, which limits their effectiveness and usability.

#### 3.2. City-Scale UHI Models

As mentioned previously, boundary-layer UHI covers the area ranging from building rooftops to the lower atmosphere. This type of UHI phenomenon is typically assessed using City-scale UHI models. Elevation is an important parameter for these models. These city-scale models typically focus on measuring large-scale UHI and Land Surface Temperature (LST) variations within a city. Fluid dynamics equations are derived by using climate and meteorological data for this specific location. A 3D model of the areas is needed, which is typically developed using remote sensing methodologies and satellite images. These are then used to produce a monitoring plan using calibrated mobile or stationary climate monitors. Analytical methods or regression analysis are then used to establish a correlation between different spatial-temporal factors and UHI intensities (Deilami, *et al.*, 2018).



**Figure 2:** The original 'local climate zone' (LCZ) classification scheme and its 17 standard classes. Source: (Stewart and Oke, 2012)

### 3.3. Regional Climate Models

Regional climate models represent another option for assessing UHI that offers several advantages compared to satellite derived, city-scale, LST models. The main advantage of regional climate models is that they are not restricted to a specific short period. They evaluate land surface temperatures, humidity, and air flow pattern for a desired longer-term period. The meteorological variables of a historical period allow for making assumptions, testing hypothesis, and developing assessment scenarios much more than a limited set of LST data. Regional climate models can also be used to test the reactions of the climate systems under different mitigation strategies and using different energy use types and consumption scenarios (Stone et al., 2019).

Heating and cooling degree-days data (CDD and HDD) offer another, and relatively easier, alternative for assessing UHI potential at the regional scale. CDD and HDD describe the climatic characteristics of a specific urban region. This data can be generated by comparing outside temperatures with the need for active heating and cooling determined depending on fixed limit values. The fixed base line is typically depicted as 65°F (18.3°C), at which thermal comfort can be achieved without the need for active heating and cooling. To calculate HDD & CDD, the relation between daily temperature and mean fixed value is analyzed. If the temperature is more than this limit, these days are counted as CDD. If it is less than this base, heating is needed, and these days are calculated as HDD. Historically tracking CDD and HDD numbers can provide an indication of the increase, or decrease, in urban temperatures and subsequently in UHI. A study of CDD in the San Fernando Valley (Los Angeles) (California Energy Commission, 2019) indicated that between the 1960s and 1990s, days in which average daily temperature exceeded 103.4°F (39.7°C) have increased by approximately 12 days per year. Based on this, the California Energy Commission has focused on policies for decreasing the number of CDDs for future scenarios

#### 4.0. IMPACT OF CLIMATE ON UHI PHENOMENON

Climatic characteristics such as temperature, relative humidity, precipitation, and air flow patterns are considered as temporal factors that affect the urban heat island intensity. Combinations of these characteristics are used to define different climate regions, which have different levels of ecological and biological diversity. These climate factors affect UHI in different ways. For example, there is a negative correlation between daily maximum UHI intensity and cloudiness. As stated above, besides temporal factors, orientation and shadow pattern of street valleys and convection heat transfer occurring due to the aerodynamic structure of the surfaces also affect UHI intensity. In the following section, differences in the characteristics of the UHI phenomenon between the three major climatic regions: hot-humid, hot-dry, and cold, are discussed. Table 1 provides a summary of the impact of climate on UHI characteristics.

**Table 1:** A summary of the impact of climate on UHI characteristics. Source: (Author 2021)

UHI Characteristics	Hot and Humid Climates	Hot and Dry Climates	Cold Climate
Daily and seasonal temperature differences	High intensity of heatwaves with average monthly temperature 18°C (64.4°F)	High temperatures reach over 49°C (120 °F) during the day and drop to 37°C or less at night	Extremely cold winters below -4°C (26°F) and hot summers between 21-32 °C (70 to 90°F)
	High humidity levels, more precipitation	Low relative humidity, low frequency and amount of precipitation	Low relative humidity, less precipitation mostly snowstorms
	Low wind velocities	Large wind velocities	Strong cold winds
	Small diurnal fluctuations in temperature	Large diurnal fluctuations in temperature	Large seasonal fluctuations in temperature
Temperature difference between urban and rural areas ( $\Delta T$ ) due to convection efficiency	Increase $3.0 \pm 0.3$ kelvin because of reduced convection efficiency with low airflow pattern and high night cloud cover	Decrease $1.5 \pm 0.2$ kelvin because of more convection efficiency with low percentages of cloud cover and evaporative cooling effect of the green areas	Increase $1.32$ °C because of higher albedo of snow covering, atmospheric pollutants caused by anthropogenic heat increase
Main factors affecting UHI Intensity	<ul style="list-style-type: none"> <li>- The transpiration of spaces</li> <li>- Vegetation</li> <li>- Geographic height pattern</li> <li>- City morphology</li> <li>- Thermal mass characteristics</li> </ul>	<ul style="list-style-type: none"> <li>- Green spaces</li> <li>- Nighttime temperature differences</li> <li>- City morphology</li> <li>- Thermal mass characteristics</li> </ul>	<ul style="list-style-type: none"> <li>- The anthropogenic heat</li> <li>- Vegetation</li> <li>- The building layout</li> <li>- City morphology</li> <li>- Thermal mass characteristics</li> </ul>

##### 4.1. Hot and Humid (Tropical) Climates

Hot and humid climates are typically characterized by high intensity of heat waves, high humidity levels, low wind velocities, and small diurnal fluctuations in temperature, all of which greatly reduce outdoor human thermal comfort. In these climates, heat from the sun is stored during daytime due to the high thermal mass capacity of built environment and impervious surfaces. The high night cloud cover is another characteristic of this climate that results in preventing the excessive heat returning to the atmosphere in dense urban districts at night. As a result of all of this, temperature differences between urban and rural areas ( $\Delta T$ ) in these hot and humid climates can *increase* by  $3.0 \pm 0.3$  kelvin because of reduced convection efficiency from the urban areas to the lower atmosphere or to the vegetated rural regions (Zhao *et al.*, 2014). Decreasing the storage and reflection capacity of the surfaces, canopy and boundary layers, high rise building schemes, high densification and providing maximum shading are proposed to reduce UHI intensity. Similarly, the use of reflective materials, increased utilization of natural vegetation, cool roofs, and pavement technologies can have a positive impact for shading and cooling in these climate regions (Jandaghian and Akbari, 2018)

##### 4.2. Hot and Dry (Arid) Climates

These climate regions are characterized by high temperatures, low relative humidity, low percentages of cloud cover, low frequency and amount of precipitation, and large diurnal fluctuations in temperature and wind velocities. They also have more convection efficiency because of their aerodynamic morphology and their prevalent vegetation types such

as shrubs and grasses.  $\Delta T$  between urban and rural areas in hot and dry climates *decreases* by  $1.5 \pm 0.2$  kelvin because of the evaporative cooling effect of the green areas (Zhao *et al.*, 2014). However, lack of precipitation and/or water bodies, either above or below ground can also have an adverse effect. In these climates, the strongest UHI is often observed during evenings and nighttime. Although these climates do not create high daytime UHI intensities, the high temperature during the daytime cause thermal discomfort for the residents and high energy consumption. Due to this, mitigation strategies for these climates mainly focus on the daytime problems and on reducing daytime UHI intensities, rather than nighttime. The most effective strategies include creating a green belt and generating breezes in periphery environment, as well as using the high-solar reflectance (cool) material for roofing and pavements. Besides climatic considerations, the north-south layout of street canyons, more compact and dense mass should be used to reduce excessive heat and provide shading. Vegetation should also be considered to decrease transpiration losses during the day and increase evapotranspiration during the night (Errel, *et al.*, 2012).

#### 4.3. Cold Climates

High-latitude and cold climates cause snowstorms and strong cold winds. Due to ongoing snow covering of the rural areas, their surface albedo becomes greater than urban areas. Anthropogenic heat through cold weather and snow, higher albedo, and thermal capacity of building materials, all combine to increase the intensity of UHI in these regions. The cold weather badly affects the evapotranspiration abilities of vegetation and the reduces the effect of green cooling. However, high UHI intensity is preferred in these climates due to the lower temperature and need of heating. Building envelope improvements and the use of high thermal mass are also less effective in these climates compared to hot-dry ones because of the low solar radiation levels. However, these improvements decrease building energy consumption, resulting in the need to find an appropriate balance point (Yang and Bou-Zeid, 2018).

### CONCLUSION

This paper directly focuses on the global UHI phenomenon, and discussed the different factors affecting the phenomenon and its intensity, measuring and modeling the UHI intensity and assessing its environmental and social impacts in different climate regions. The paper aims to provide designers, planners, decision-makers and policy makers with a better understanding of the current state of knowledge with regard to the UHI phenomenon, its negative impacts as well as the pros and cons of using different UHI assessment methodologies at both the building, city, and regional scales. Based on the paper, even though the urban heat island phenomenon is a global issue and have common properties for different areas, its impacts and implications are locally and regionally specific. A better understanding of local climate conditions and site characteristics are therefore needed for determining the appropriate measuring and modelling techniques as well as the effective mitigation strategies for every region. These selections should also be informed by the scale and the synoptic/mesoscale characteristics of the region.

As discussed in the paper, UHI is affected by both temporal and spatial characteristics. From a planning and urban design perspective however, it is clear that UHI is affected by urban characteristics such as city features, morphology and population, topographical properties, integration of green infrastructure, use of aquatic elements and weather assets, among others. Understanding the relative impact of these urban characteristics on UHI and its intensity can help planners prioritize mitigation strategies and interventions. As a future phase of the work discussed in this paper, a specific region will be chosen for further study in order to investigate the relative impact of different urban characteristics on UHI. This next phase will rely on historical satellite data to explore the relationship between different urban parameters, such as land use characteristics, surface albedo, land use differences, building and population density, changing green infrastructure elements on the one hand, and changes in surface temperatures on the other. This analysis will then be used to identify mitigation strategies offering the most potential for positive impact, while at the same time offering significant additional advantages to climate change and improving human health and quality of life.

### ACKNOWLEDGEMENTS

The authors are grateful to The Fulbright Association, Institute of International Education (IIE) and The Turkish Fulbright Commission for providing fund to their work.

### REFERENCES

- Akbari, Hasem, Dionysia Kolokotsa. 2016. "Three decades of urban heat islands and mitigation technologies research". *Energy and Buildings* 133: 834–842. <https://doi.org/10.1016/j.enbuild.2016.09.067>
- Becker, Giseke, Richard Mohren. 1990. "The Biotope Area Factor as an ecological parameter: Principles for its determination and identification of the target". Accessed January 17, 2021. [https://www.berlin.de/senuvk/umwelt/landschaftsplanung/bff/download/Auszug\\_BFF\\_Gutachten\\_1990\\_eng.pdf](https://www.berlin.de/senuvk/umwelt/landschaftsplanung/bff/download/Auszug_BFF_Gutachten_1990_eng.pdf).
- California Energy Commission. 2019. "Monitoring the urban heat island effect and the efficacy of future countermeasures". Accessed January 17, 2021. <https://ww2.energy.ca.gov/publications/displayOneReport cms.php ?pubNum=CEC-500-2019-020>



- Deilami, Kaveh, Md. Kamruzzaman, Yan Liua. 2018. "Urban heat island effect: A systematic review of spatio-temporal factors, data, methods, and mitigation measures". *International Journal Applied Earth Observation Geoinformation* 67: 30-42
- Dirksen, Marieke, Reinder J. Ronda, Natalie E. Theeuwes, Giuliano Andrea Pagani. 2019. "Sky view factor calculations and its application in urban heat island studies". *Urban Climate* 30: 1-16
- Errel Evyatar, David Pearlmutter, and Terence Williamson. 2012. *Urban Microclimate: Designing the spaces between buildings. 1st edition*. New York: Routledge.
- Hien, Wong N., and Steve Kardinal. 2009. "Air temperature distribution and the influence of sky view factor in a green Singapore estate". *Journal of Urban Planning and Development* 136(3): 261-272  
<https://www.who.int/news-room/fact-sheets/detail/climate-change-and-health>; 2018
- Huang, Pao-Shen, Su-mei Tsai, Hui-Chen Lin, I-Min Tso. 2015. "Do Biotope Area Factor values reflect ecological effectiveness of urban landscapes? A case study on university campuses in central Taiwan". *Landscape and Urban Planning* 143: 143-9.
- Intergovernmental Panel on Climate Change. 2014. "AR5 Synthesis Report: Climate Change 2014". Accessed January 17, 2021. <https://www.ipcc.ch/report/ar5/syrl>.
- Jandaghian, Zahra, Hazem Akbari. 2018. "The effect of increasing surface albedo on urban climate and air quality: A detailed study for Sacramento, Houston and Chicago". *Climate* 6(2): 19-40
- Kumar P., Lidia Morawska, Claudio Martani, George Biskos, Marina Neophytou, Silvana Di Sabatino, Margaret Bell, Leslie Norford, Rex Britter. 2015. "The rise of low-cost sensing for managing air pollution in cities". *Environment International* 75: 199-205. <https://doi.org/10.1016/j.envint.2014.11.019>.
- Martin-Vide J, Pablo Sarricolea and M. Carmen Moreno-García. 2015. "On the definition of urban heat island intensity: the "rural" reference". *Frontiers in Earth Science* 3: 24. doi:10.3389/feart.2015.00024
- Milligan, Brett. 2010. "Corporate ecologies". *Journal of Landscape Architecture* 5(1): 6-23.
- Nayak, Seema, Srishti Shrestha, Patrick L. Kinney, Zev Ross, Scott C. Sheridan, Cristian I. Pantea, Wanhsiang Hsu, Neil Muscatiello, Syni An Hwang. 2018. "Development of a heat vulnerability index for New York State". *Public Health* 161: 127-137
- Oke, TR. 1982. "The Energetic Basis of the Urban Heat Island". *Quarterly Journal of the Royal Meteorological Society* 108(455): 1-24.
- Stewart, Iain D, TR. Oke. 2012. "Local climate zones for urban temperature studies". *The Bulletin of the American Meteorological Society* 93(12): 1879-1900
- Stewart, Iain D. 2011. "A systematic review and scientific critique of methodology in modern urban heat island literature". *International Journal of Climatology* 31(2): 200-17.
- Stone B. J., Lanza K., Mallen E., Vargo J., Russell A. (2019). Urban Heat Management in Louisville, Kentucky: A Framework for Climate Adaptation Planning. *Journal of Planning Education and Research*, 1-13
- United States Environmental Protection Agency, 2016/2017. "Heat Island Effect". Accessed January 17, 2021. <https://www.epa.gov/heatislands>.
- Unwin D. J. (1980). The synoptic climatology of Birmingham's urban heat island. *Weather* 1980; 35(2): 43-50.
- Voogt, James. 2014. "How researchers measure urban heat islands: Urban heat island webcasts and conference". Accessed January 17, 2021. [https://19january2017snapshot.epa.gov/sites/production/files/2014-07/documents/epa\\_how\\_to\\_measure\\_a\\_uhi.pdf](https://19january2017snapshot.epa.gov/sites/production/files/2014-07/documents/epa_how_to_measure_a_uhi.pdf)
- World Health Organization. n.d. 2018. "Climate Change and Health." Accessed January 17, 2021.
- World Urbanization Prospectus. 2018 "Department of Economic and Social Affairs United Nations." Accessed January 17, 2021. <https://population.un.org/wup/Publications/Files/WUP2018-Report.pdf>.
- Yang, Jiachuan, Eli Bou-Zeid. 2018. "Should Cities Embrace Their Heat Islands as Shields from Extreme Cold?" *Journal of Applied Meteorology and Climatology* 57: 1309-1320.
- Zhang, Jian, Zhonghua Gou; Yi Lu; Pingying Lin. 2019. "The impact of sky view factor on thermal environments in urban parks in a subtropical coastal city of Australia". *Urban Forestry & Urban Greening* 44: 1-18.
- Zhang, X., Zhong, T., Feng, X., Wang, K., (2009). Estimation of the relationship between vegetation patches and urban land surface temperature with remote sensing. *International Journal of Remote Sensing*; 30: 2105-2118.
- Zhao, Lei, Xuhui Lee, Ronald Smith, Keith Oleson. 2014. "Strong contributions of local background climate to urban heat islands". *Nature* 511: 216-9

# Methodology to Incorporate the Value of Sustainability in Buildings

Sandra Guerrero<sup>1</sup>, Irene Marincic<sup>1</sup>

<sup>1</sup>University of Sonora, Hermosillo, Sonora, Mexico

**ABSTRACT:** The implementation of new technologies and systems applied in real estate to improve people's living conditions, represent benefits on various aspects that have a positive impact on the reduction of energy consumption, on savings on consumption expenditure, and quality impact on the improvement of the environment. The application of the norms of the new urban agenda on Real Estate and the sustainability factor in buildings obliges to include in the methodologies established for the valuation of real estate new indicators that represent and add value to the property. For this reason, we present this proposal for establishing sustainability indicators that can be incorporated into the methodologies used for real estate valuation and provide parameters that benefit not only the user and owner of the property but the environment in general.

Through this paper we present a real estate valuation methodology, which considers the sustainable aspects of the real state to be valued, it includes the environmental variables of energy efficiency, and the use of water management and trees, in its analysis. These variables are applied as a sustainability factor that affects the final value of the real state obtained by traditional methods.

**KEYWORDS:** Sustainability, Real state valuation, Energy efficiency

## INTRODUCTION

The climate and the environment have been of great importance for the development of civilizations, since its origins the human being has adapted to these conditions to improve their quality of life, through the observation of these phenomena in their context environmental, has developed strategies that allow you to live in harmony with it.

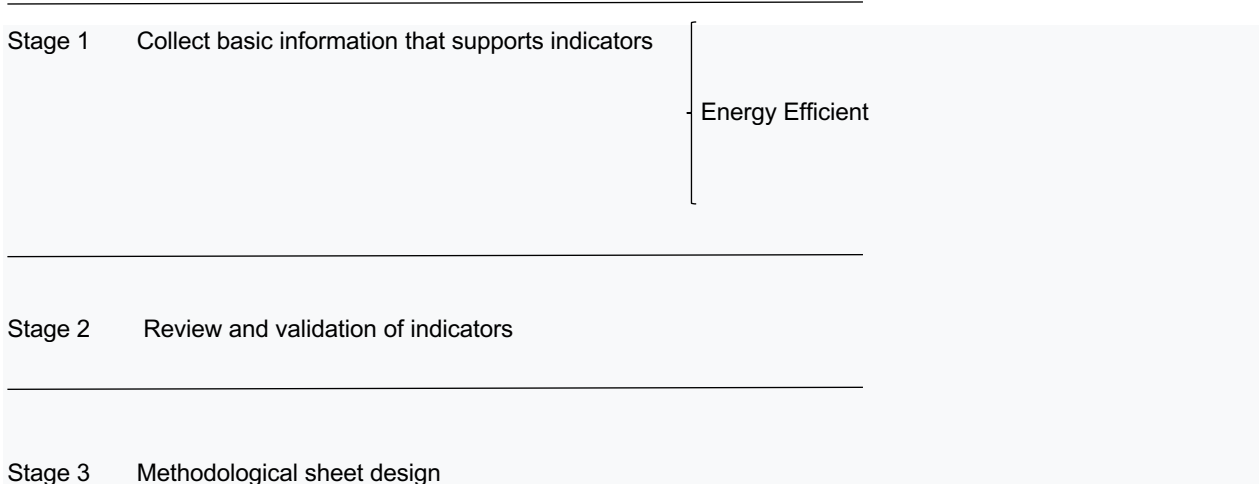
At present, terms of housing development consider aspects in the improvement of the quality of life of people through the application of sustainable strategies, which contribute to reducing the impact of the deterioration of the environment caused by global warming. Here, we address the impact that the implementation of these strategies has on buildings; and determine if it represents an additional value on the property and how to monetize it, as well as the benefits that the implementation of these strategies would have on the environment. It is proposed to know the value of sustainable strategies and to integrate this value indicator into a methodology in the procedures within the valuation.

In Mexico, the practice of Valuation uses a variety of methodologies and criteria to determine the value of the real state. Valuation is considered a multidisciplinary technique, which includes in its application different Procedures regulated by institutions in the Federal sphere. They are Sociedad Hipotecaria Federal (SHF), Instituto de Administration y Avaluos de Bienes Nacionales (INDAABIN), and the General Law of National Assets, among others. For traditional housing, they can be applied effectively, but for cases or analysis in matters of environment and sustainability, it is considered that there is a gap that does not reflect that condition that can mean savings in the consumption of basic services in the medium or short term, as well as a positive impact on the environment, in this way the existing methodologies can be complemented with these indicators.

The proposed methodology is more pertinent for middle-residential housing, in which it is more feasible to implement aspects that make the performance of the property more efficient for those who live in it. The methodology and technical procedures of the valuation that are used today are analyzed to integrate the value of the sustainability aspects, established within the value of the asset. The analysis presented here is based on a single indicator: energy efficiency.

These are taken as parameters before and after the implementation of solar panels in a home, the impact on reducing energy consumption will also be analyzed. CO2 emissions. To complete study, is proposed the analysis of other indicators, can be implemented; some passive strategies such as sunlight, adequate use of water, and others. To present this proposal, only one analyzed case is.

The indicator construction process is divided into three stages that are described in the following image (Figure 1):



**Figure 1.** Methodology stages diagram. Source: (Guerrero 2020)

When defining the sustainable performance indicators, these will be integrated into the methodological procedure of the real estate valuation, expressed in a factor or indicator for sustainability that affects the value of the property. This method is expected to obtain a sustainability factor that can be applied to the value of the property and thus analyze the efficiency of the strategies implemented in the home to mitigate the negative effects on the environment.

**1.0. PROPOSAL TO INCORPORATE SUSTAINABILITY INDICATORS TO THE VALUATION METHOD**

Once defined the variables, we obtain the sustainability factor through the following premise: Considering the savings obtained overtime during the useful life of the property, brought to Present Value (VAN), minus the cost of the investment, minus its depreciation, divided by the commercial value of the property: to know the real value of the Investment. To be able to consider these variables, some aspects such as the type of home being analyzed would have to be taken into account since according to its classification (SHF, 2012), the use of each of these variables (a type of property, quality, surface), and it would not be the same for a low-income home as for a Residential home. The table that reflects the data for both cases is the following:

**Table 1.** Property features. Source: (Guerrero 2020)

Indicators	Classification according to SHF	Value Range	% savings	Investment
Energy Efficient	Low cost	0 to 350,000.00	top	Equipment/savings
	Social interest	351,000-750,000		
	Middle	750,000 -1,500,000		
	Residential	1,501,000.00 +		

Once these data are analyzed, the following formula is finally proposed to obtain the sustainability factor:

$$F_s = \frac{VAN - [I - D]}{VI} \tag{1}$$

Where:

**F<sub>s</sub>** = Sustainability factor

**VAN** = Present Value

**I** = Cost of Investment

**D** = Depreciation

**PV** = Property Value (Commercial Value)

And the application of [1] in both proposals would be represented as follows:

$$\text{Value for sustainability} = \text{Commercial value} \times \text{Sustainability factor} \quad [2]$$

The sustainability factor according to the variables analyzed or that apply to each specific case would be reflected as follows:

$$F_s = F_{Ee} + F_{Aa} + F_v \quad [3]$$

Where:

- F<sub>s</sub>** = Sustainability factor.
- F<sub>Ee</sub>** = Energy efficiency factor.
- F<sub>Aa</sub>** = Water use factor.
- F<sub>V</sub>** = Factor for Vegetation

The sustainability factor to apply to the value of the property analyzed would be the sum of the factors analyzed for each of the variables that are considered in each analysis in particular. The following graphic shows how the proposed methodology is applied (Figure 2).

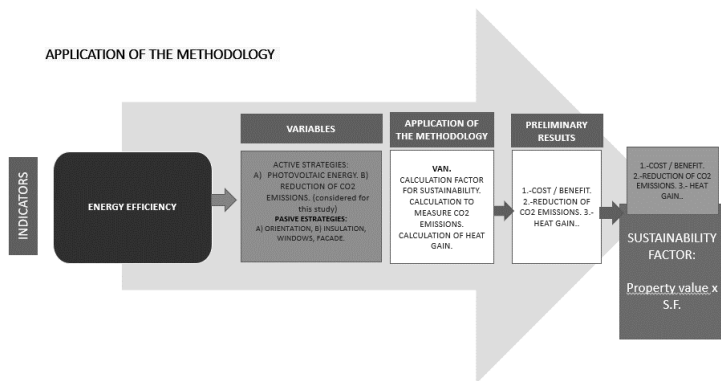


Figure 2. Methodology. Source: (Guerrero 2020)

## 2.0. ANALYSIS OF ENERGY EFFICIENCY AS AN INDICATOR

For this indicator will be analyzed: Efficient use of energy, energy-saving, reducing the amount of energy from non-renewable sources, required to supply the supply of electricity services in the home, saving in consumption costs, and reducing emissions of CO2 will be the variables to be determined.

### 2.1. Indicator Objective

Measure energy efficiency through the following parameters and ranges: Photovoltaic energy through the installation of solar panels, cost-benefit and investment recovery, reduction in CO2 emissions.

The results to be obtained are:

- Investment cost / Investment recovery time.
- Energy consumption before and after the implementation of solar panels. Total percentage of final use energy derived from renewable sources, consider a range of 0-100%, taking into account the premise without solar panels - with solar panels.
- Savings in consumption after the implementation of solar panels. Savings in kWh consumption, considering the range. 0-100%. Savings in consumption expenses in the range of 0-100%.
- Sustainability Factor.
- Impact on reducing CO2 emissions.

### 2.2. Procedure

To analyze this indicator, a house that registers a high consumption of electrical energy and therefore high costs for service was considered, the house is located in Hermosillo, Sonora, northwest of Mexico and in a desert area where the solar incidence is high during a long period of the year and that due to these characteristics the strategy of using photovoltaic energy is feasible to implement. The data of your energy consumption are analyzed for a period of one

year without the installation of any device to reduce consumption and costs. This analysis is based on the ratio of the percentage of decrease in energy consumption per dwelling in an annual period compared to a property before installing solar panels and after implementation, analyzing its behavior in a period of one year in both conditions, considering mainly the aspects of saving in consumption and the use of non-polluting renewable sources.

It will also be considered later to estimate CO2 emissions and their behavior once the photovoltaic energy system is implemented. It will be considered based on the data obtained from the consumption in kWh, which is the decrease in CO2 emissions.

**2.3. Case study.**

The property is located in Colonia Pitic in the city of Hermosillo, Sonora. The reasons, to chose it, are because it has the implementation of solar panels and will be analyzed within the study of energy efficiency through photovoltaic energy. It is important to consider for the analysis question some other characteristics that the property presents and that are parameters to correctly evaluate this indicator, such as construction material, if it has any thermal insulation, or other factors that influence the amount of heat absorbed by the property, among other aspects, for the analysis of this indicator it is also required to have the initial value of the property, for this reason, some elements that the property possesses are also considered to be able to carry out the valuation correctly.

**2.4. Datta collection method**

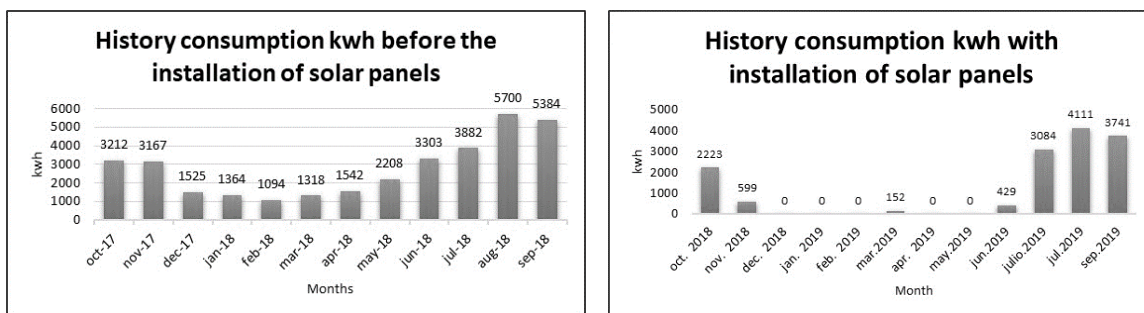
For this, the consumption record in the property was analyzed during the period of one year from October 2017 to September 2018 before the installation of solar panels (Figure 3), and the same data was analyzed in the period between October 2018 to October 2019, once the solar panels were implemented, and the results obtained are shown below (Table 2).

**Table 2.** Consumption and cost records. Source: (Guerrero 2020)

HISTORY COMSUMPTION PROPERTY PITIC							
	MONTH	Kwh	TOTAL \$		MONTH	Kwh	TOTAL \$
WITHOUT SOLAR PANELS	oct-17	3212	\$29,918.00	WITH SOLAR PANELS	oct. 2018	2223	\$4,268.54
	nov-17	3167	\$27,609.00		nov. 2018	599	\$507.00
	dec-17	1525	\$19,161.00		dec. 2018	0	\$75.00
	jan-18	1364	\$8,105.00		jan. 2019	0	\$75.00
	feb-18	1094	\$6,682.00		feb. 2019	0	\$75.00
	mar-18	1318	\$5,506.00		mar.2019	152	\$79.00
	apr-18	1542	\$6,633.00		apr. 2019	0	\$79.00
	may-18	2208	\$7,326.00		may.2019	0	\$78.00
	jun-18	3303	\$14,824.00		jun.2019	429	\$372.00
	jul-18	3882	\$14,938.00		jul.2019	3084	\$5,711.00
	aug-18	5700	\$25,154.00		aug.2019	4111	\$9,163.79
	sep-18	5384	\$17,521.00		sep.2019	3741	\$6,898.00
TOTAL COST IN 12 MONTHS (WITHOUT SOLAR PANELS)--->			\$183,377.00	TOTAL COST IN 12 MONTHS (WITH SOLAR PANELS)--->			\$27,381.33

For the project of the house in Colonia Pitic, the investment was 440,000.00 Mexican pesos, achieving a recovery of the investment in a time of 2.5 years.

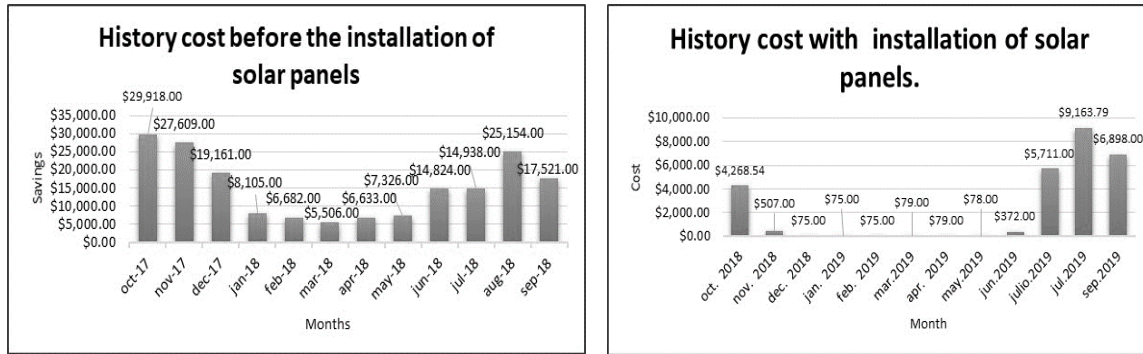
Next, the graphical data is shown grouped by annual consumption in kWh, through the electricity grid without solar panels, and with the implementation of them.



**Figure 3.** Consumption history without solar panels and with solar panels. Source: (Guerrero 2020)

The history of consumption in kWh reflects significant variation, the parameters to evaluate that were considered are the period within the months of the subsidy in the rate available to the State of Sonora, for the year 2018 and the same months in the year 2019, These average ranges are the difference between the consumption before the installation of Solar Panels and after the installation and give us these data: 2273 kWh / 4095.4 kWh and the result is an average consumption saving of 44.5%.

The graphical results of the data obtained from the cost of energy supply before and after the implementation of the solar panels are presented below.



**Figure 4.** Annual electricity cost after and before the installation of a solar panel. Source: (Guerrero 2020)

Regarding the history of payment for consumption, the results obtained are favorable concerning the savings obtained when installing the solar panel system in the house, these data show an important difference, since the relationship in the amount of consumption before the installation of the photovoltaic system and after it represents 72% less than the payment over the previous period, considering the following average ranges: 15,952.60 before and 4,444.55 as can be seen in Figure 4.

From these data, we will work on the indicators such as sustainability coefficients that will be applied in the methodology to value a property.

$$AhC = [(Cp \text{ red} + ps / cp \text{ red}) - 1] (100) \tag{4}$$

Where:

- Ah C** = Savings in Consumption in kWh
- Cp** = Average consumption with the mains supply.
- Ps** = solar panels

If we consider the average of the hottest months of the year, with and without panels, the results are:

$$\text{Average consumption } 2273 \text{ kWh} / 4095.4 \text{ kWh} = 0.555 (-1) = .445 (100) = 44.5\%$$

This would be the annual kWh consumption of the highest point represented by the months with the highest temperatures of the year, which in this analysis represents a difference of 44.5%, the consumption does vary, since it decreases and we also consider as part of the efficiency the source of supply, we can use this same scheme to determine the cost savings after installing solar panels.

The savings in the total paid for consumption in the indicated period would be as follows:  
 $4,444.55 / 15,952.6 = .28 (-1) = .72 * 100 = 72\%$



### 2.5. Valuation Method and Energy Efficiency results

Once this data is analyzed, it is possible to work with the formula [1] to obtain the factor for sustainability.

According to the appraisal made, the value of the analyzed property is estimated at:

**Table 3:** Property Data. Source: (Guerrero 2020)

Construction Surface	Commercial Value
265.00 m2	\$7,450,000.00

The calculation of the net present value (VAN) is used in the following equation:

$$VAN = -I_0 + \sum_{t=1}^n \frac{F_t}{(1+k)^t} = -I_0 + \frac{F_1}{(1+k)} + \frac{F_2}{(1+k)^2} + \dots + \frac{F_n}{(1+k)^n}$$

Net Present Value (NPV ó VAN) is the sum of the present value of individual cash flows, through transferring the flows of an asset to the current date, through its discount factor.

**Table 4.** Flujo de efectivo, VAN. Source: (Guerrero 2020)

Discount rate:	12%
VAN:	\$ 507,450.00

It should be noted that the cash flow was made considering the useful life of the solar panels, which is estimated to be about 25 years, concerning the useful life of the good. Its maintenance is very basic, it does not require more than cleaning every so often, the value of solar panels each year detracts from its value by approximately 8%, according to a distributor source. Another important aspect to consider is the discount rate to be used since the variation in the parameters depends on it, in this case, it is considered a high rate, taking into account the investment risk for the period of years in which the implemented system.

The net present value based on these parameters:

The calculation of the net present value (VAN) is used in the following equation:

$$F_s = 507,450.00 - 352,000.00 / 7,450,000.00$$

Therefore, the factor for sustainability by solar panels, according to this method would be:

$$F_s = 0.021$$

The sustainability factor to apply to the value of the analyzed property would be the sum of the factors analyzed for each variable considered at every analysis.

### 3.0. ANALYSIS OF CO<sub>2</sub> EMISSIONS

Another important aspect in the study of energy efficiency and that is mentioned at the beginning, is to know the positive impact that the reduction in the emission of greenhouse gases due to energy consumption has on the environment, and to raise awareness of the importance to consider these guidelines in all those satisfiers that are implemented in the home to expand comfort.

For the application of this method, a CO<sub>2</sub> emission factor must be considered, which is attributed to the electricity supply, the electricity mix CO<sub>2</sub> / KWh, which represents the associated emissions from electricity consumption.

The gross production mix recommended by the OCCC, to be used for 2012, is 300 g CO<sub>2</sub> / kWh. In the case of the analyzed property, we will consider the following data (Generalitat de Catalunya, 2011):

**Table 5:** Reduction analysis of CO2 emissions

Initial	Final
Energy consumption= 33, 699 KWh year	Energy consumption = 33,699 - (33,699 x 0.42) = 33,699 - 14,154 = 19,545
Emissions CO2= 33,699 kWh/ year x 300 g de CO2/kWh) = 10,109,700 g de CO2/year	Emissions CO2 = 19,545 kWh/ year x 300 g de CO2/kWh) = 5, 863,500 g de CO2/ year

Therefore, the savings in CO2 emissions per year is: Emissions de CO2 = 19,545 kWh/year x 300 g de CO2/ kWh) = 5, 863,500 g de CO2/ year.

### CONCLUSION

Once all the parameters considered to measure this indicator have been analyzed, the proposed formula will be applied to increase the commercial value of the property, which will become the final factor for sustainability. This method should be applied on any analysis or real estate valuation methodology, using the market method, the physical approach method, or even the income method interchangeably; the flexibility of application though the different methods is an advantage because it does not condition the use of one of them in specific, it is simply added to the final value of the real state.

This paper highlights the importance of implementing strategies that contribute on improving people's living conditions by optimizing the costs involved in air conditioning space in desert areas, where there are very high temperatures most of the year, and where the rain is scarce. In the same way, it seeks to have a positive impact, and to increase awareness of the importance of caring for the environment.

### ACKNOWLEDGEMENTS

The financial support of CONACyT is hereby gratefully acknowledged.

Mexico,D.F.: Universidad Autonoma Metropolitana, 1996.  
 Compendio Tecnico, INDAABIN. "Métodos, fórmulas y factores, propuestos por la Dirección General de Avalúos de la INDAABIN, Delegación Regional Golfo Centro y Delegación Regional Pacífico Centro." Mexico, 2009.  
 CONAVI. *Código de Edificación de Vivienda*. México: Gobierno Federal, 2010.  
 CONUEE, Secretaria de Energia. *Manual Tecnico para la aplicación de la Nom-020-ener-2011*. Mexico: Consorcio GOPA-INTEGRATION, 2015.  
 Generalitat de Catalunya, Comisión Interdepartamental del cambio climático. *Guía práctica para el cálculo de emisiones de Gases Efecto Invernadero*. Catalunya, España.: Generalitat de Catalunya, Comisión Interdepartamental del cambio climático., 2011.  
 Hernández-Ruiz, Enrique. *Teorias y praxis de la valuacion de bienes , derechos, proyectos y negocios en marcha..* MEXICO: TRILLAS, 2005.  
 Indaabin. *Glosario de Terminos en Valuación*. Mexico: Procedimientos Tecnicos, Normatividad, 2009. Olgay V. *Arquitectura y Clima*. Barcelona, España: GG, 2014.  
 Ostrom, Elinor. *A General Framework for Analyzing Sustainability of Social-Ecological Systems*. Science, 2009: 419-422.  
 Parellada, Ángela . *Eficiencia Energética, Ciudades para un futuro más sostenible*. Madrid, España, 2008.  
 Publicación de las Naciones Unidas, CEPAL. *Informe nacional de monitoreo de la eficiencia energetica de Mexico, 2018*. Mexico: LC/TS.2018/41, 2018.  
 Sociedad Hipotecaria Federal, SHF, *Modificación a las reglas de carácter general que establecen la metodología*. México. Diario Oficial de la Federación, 2012.  
 Vaqueira, Manuel. *Introduccion a la Arquitectura Bioclimática*. Mexico: Limusa, 2002.



# LEED-certified Buildings Versus Non-LEED-certified Buildings: A Deep Dive into the Performance

Ming Hu<sup>1</sup>

<sup>1</sup>University of Maryland, College Park, MD

**ABSTRACT:** This study aims to understand the actual performance difference between LEED buildings and non-LEED buildings. Since 2012, the District of Columbia (DC) has amended regulations so that all buildings must report their building energy use. We have cross-referenced the most recently published data of the 2019 DC energy benchmarking database with the U.S. Green Building Council's LEED project database to identify DC properties in both databases that are expected to reduce building operating energy use and greenhouse gas emissions. We compared LEED office buildings and non-LEED-certified office buildings using their reported operating source and site energy use intensity (EUI). The results show that LEED office buildings do not perform better at any of the certified levels. On the contrary, those reported LEED buildings collectively use 17% more source energy and 13% more site energy than non-LEED buildings. Among the different LEED levels, LEED *Silver* appears to perform slightly better than the other LEED levels. Meanwhile only around 33% of qualified LEED office buildings reported their actual energy use according to the DC regulation. The purpose of this study is not to criticize the LEED rating system; instead, we want to improve the system in order to meet DC's carbon neutrality goal. To this extent, we conclude that the U.S. LEED rating system can benefit from learning from other green building rating systems that include reporting and verification as prerequisite requirements.

**KEYWORDS:** LEED, Simulation, Reality, Performance

## 1.0 INTRODUCTION

Commercial buildings are a large energy consumer. In 2012, large commercial buildings in the United States had more than 25,000 ft<sup>2</sup> of floor space each, accounting for about 69% of total commercial building energy use [1]. Larger commercial buildings, covering over 200,000 ft<sup>2</sup>, only accounted for 1% of total commercial buildings, but they contributed to 26% of the total commercial building energy consumption [1]. Among commercial buildings, offices accounted for 18% of total floor space and 20% of overall site energy use, with the latter being the largest category (for energy-consuming) in commercial buildings [1]. Reducing office energy use not only has a bigger impact on overall commercial building energy performance improvement but also can provide some valuable lessons for other commercial building categories.

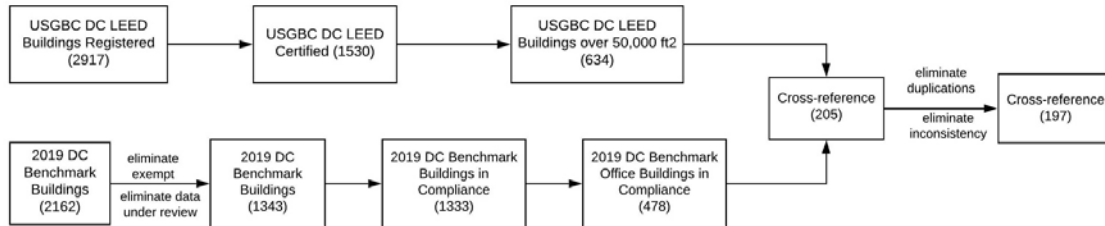
Leadership in Energy and Environmental Design (LEED), by the U.S. Green Building Council (USGBC), is the most widely used green building certification in the United States. Since its establishment in 2000, the credibility of LEED certification has been debated. Most criticism is centered around the actual energy performance of LEED-certified buildings and whether LEED actually implies energy efficiency and sustainability [1]. Amiril et al. (2019) reviewed 44 peer-reviewed articles focusing on the energy performance of LEED buildings. Ten papers concluded that LEED buildings had higher energy efficiency, eight studies stated the opposite conclusion, and the remaining papers did not articulate the comparison. However, the consensus is that the energy efficiency of LEED buildings is questionable, and modifications to the LEED Energy and Atmosphere category are recommended to improve actual building performance [2]. In the past several years, the mid-Atlantic region has remained the "LEED building leader," which is perceived as a progressive region leading the efforts to pursue sustainable design [iii]. The District of Columbia has consistently led the nation in registering and certifying LEED buildings. In 2018, the city certified 61.74 ft<sup>2</sup> of space per resident across 145 building projects, which is more than 10 times the per capita number for top-ranked states, such as Illinois [3]. It is necessary to investigate the actual performance of those LEED buildings in DC.

In 2008, DC passed the Clean and Affordable Energy Act (CAEA), which requires that all buildings with a gross floor area of 50,000 ft<sup>2</sup> (4,645 m<sup>2</sup>) or greater to report their actual building energy and water use annually. The DC government must also annually benchmark and disclose the energy and water efficiency of district government buildings over 10,000 ft<sup>2</sup> (929 m<sup>2</sup>) [iv]. The benchmarking is done according to the ENERGY STAR Portfolio Manager® by the U.S. Environmental Protection Agency (EPA), which is an industry-standard free online tool [v]. It was developed to provide a method for comparing the energy consumption of a commercial building with that of similar activities, adjusting for size, climate, and operational characters [vi vii]. This method makes it possible to determine the actual

LEED building performance by cross-referencing DC energy benchmarking data (from the DC government website) and LEED project inventory (from the USGBC website) to understand whether LEED office buildings perform better than non-LEED buildings.

## 2.0 MATERIALS AND METHOD

The overall data cleaning and searching process is illustrated in figure 1.



**Figure 1:** Data-acquiring process

### 2.1 Energy benchmarking data

Since 2012, the District of Columbia has released benchmarking data for more than a thousand buildings under the benchmarking law [viii]. It includes all private buildings over 50,000 gross ft<sup>2</sup> within the District of Columbia, including multifamily residences, offices, education buildings, mixed-use buildings, hospitals, libraries, hotels, K-12 schools, supermarkets, colleges/universities, restaurants, and police stations, among others. The following data was reported: 1,591 buildings in 2013, 1,849 buildings in 2014, 2,015 buildings in 2016, 1,847 buildings in 2017, 2,095 buildings in 2018, and 2,162 buildings in 2019. For this study, we use the dataset from 2019 (based on 2018 operations), which has the highest data reporting compliance: 1,343 buildings. Among all buildings included in the 2019 report, we excluded buildings that were exempt from 2019’s disclosure, those that currently have data under review, and those with no report received, which resulted in 1,333 buildings. Among those buildings, the building types included commercial office buildings (478), K-12 schools (29), and multifamily housing (556); the remaining buildings cover 35 other building types. The released data includes both descriptive and energy use information; table 1 lists the specific information released for each building [9].

Table 1 Building properties extracted from the Washington, D.C. public Building Benchmarking Portal [ix]

Property Description	Energy Use	CO <sub>2</sub> Emissions
Property name	Energy star score	Total emissions (GHG)
Address	Source EUI	Total emissions intensity (GHG)
Zip code	Site EUI	
Property type	Weather normalized source EUI	
Owner	Weather normalized site EUI	
Ward	Electricity use	
Year built	Natural gas use	
Gross floor area		

The USGBC publishes a database of all LEED-registered buildings worldwide. When we extracted the inventory from the USGBC website (May 2020), USGBC had nearly 126,177 buildings; 97,378 in the United States, with 2,917 in Washington, D.C., and none of the DC buildings were listed as confidential without further identifying information. Among 2,917 buildings, 1,530 of those buildings were certified at different levels, and only 7 buildings were reported to have been certified before January 1, 2008, the beginning of the year for which DC energy benchmarking data was mandated.

Another database we used as a baseline comparison was the Commercial Buildings Energy Consumption Survey (CBECS) data, which was published on the U.S. Energy Information Administration (EIA) website. EIA is the organization responsible for conducting surveys of building energy use and managing and publishing CBECS data. In 2018, EIA released the most recent CBECS data, which was based on a 2015 survey. CBECS provided a snapshot of the U.S. commercial building sector characteristics and energy performance [x].

## 2.2 Energy measurement metric: gross EUI

The energy use intensity was chosen as a measuring unit and is measured by the energy use kWh (kBtu in the U.S.) divided by the total gross floor area of a building in m<sup>2</sup> (ft<sup>2</sup> in the U.S.). Regarding individual buildings' energy efficiency, both the mean EUI [x<sup>xi</sup>] and median EUI [x<sup>xii</sup>] have been used to compare LEED buildings and non-LEED buildings in previous studies [8]. The EPA has been using the mean EUI as a benchmark tool to measure the decrease of energy use in U.S. buildings [x<sup>xiii</sup>]. However, simply using the reported EUI of individual buildings to calculate the mean or median EUI can lead to misleading results. This study adopted a method proposed and verified by Dr. John H. Scofield in 2013 [x<sup>xiv</sup>]. He demonstrated that using the EUI (mean or median) of an individual building for calculation of the mean or median EUI of a set of buildings actually treats small and large buildings equally, despite large buildings contributing more total energy. This discovery has been clearly demonstrated in his Chicago LEED building study [x<sup>xv</sup>]. He showed that even when two buildings' sets have identical numbers of buildings and an identical total floor area, it is possible for one set of buildings to use more energy than the other set, despite having a lower mean or median EUI [16]. Therefore, Scofield proposed a mathematically consistent and useful generalization of EUI for a set of N buildings, where the gross EUI (GEUI) is calculated (see the following equation), which is the mathematical equivalent of the area-weighted mean EUI,  $\bar{e}$  [x<sup>xvi</sup>].

$$\bar{e} = \frac{\sum E_j}{\sum A_j}$$

where  $\sum A_j$  is the total floor area for the building set, and  $\sum E_j$  is the total energy use for the building set.

GEUI is used by the U.S. Energy Information Administration for the U.S. Commercial Buildings Energy Consumption Survey, which has been used by many researchers to study building energy use and efficiency. GEUI can be used to compare sets of buildings with different numbers of buildings and different total floor areas. In addition, source energy is used in this study, since source energy provides a more accurate measurement of understanding the total energy impact of a building.

## 2.3 LEED building identification

DC benchmarking data does not include LEED certification information to identify the LEED-certified buildings that also reported the actual building energy use in the DC benchmarking database. We cross-referenced the 2019 benchmarking database with USGBC's LEED project directory, extracted in May 2020, which included projects registered by December 2019. There are 643 projects with a floor area over 50,000 ft<sup>2</sup> (4650 m<sup>2</sup>) that were certified at levels from *Certified* to *Platinum*. The rating system includes New Construction, Core and Shell, School, BD+C, and EB O+M [x<sup>xvii</sup>].

Then, based on the project names and street addresses, we searched for all of the LEED-certified buildings in the DC benchmarking data file. This process allowed us to identify 205 office buildings that were included in both the DC benchmarking database and LEED projects library. Among the 205 buildings, there are five buildings that share the same street address, which means that one property corresponds with two or more different LEED projects at different certification levels. For example, one LEED project was certified as LEED *Silver* and another was certified as LEED *Gold*. However, in the benchmark report, there is only one project reported. The reported floor areas listed in the two databases were not identical; therefore, it was hard to determine which LEED project was reported in the benchmarking database. Consequently, we excluded those projects in the analysis. We also matched the gross floor area in the two databases; not all buildings have a matching reported floor size. We excluded the projects that have a difference in the reported floor area that is over 10%. There are a couple of buildings that have been certified twice; for instance, one building was certified as *Silver* in 2010 and then certified as *Platinum* in 2018. In this study, the higher and more recent certification was used to reflect a recent energy performance measurement. This resulted in 197 buildings for the analysis; the breakdown of the 197 office buildings is illustrated in table 2.

**Table 2:** LEED office buildings included in the study

LEED Level	Buildings (N)	Medium Gross Floor Space		GEUI (source)		GEUI (site)	
		(ft <sup>2</sup> )	(m <sup>2</sup> )	kBtu/ft <sup>2</sup>	kWh/m <sup>2</sup>	kBtu/ft <sup>2</sup>	kWh/m <sup>2</sup>
Certified	16	97,665	9,073	154.4	487.1	49.2	155.2
Silver	54	234,534	21,788	142.2	448.6	54.2	171
Gold	104	282,223	26,219	155.6	490.9	56.5	178.2
Platinum	24	247,330	22,977	148.7	469.1	58.3	183.9



### 3.0 RESULTS

In 2019, according to the DC benchmarking database, as mentioned earlier, 1,333 buildings are in compliance with the reporting requirements. Among the 1,333 buildings, there is a total of 478 office buildings, which account for 36% of all buildings in the benchmarking database. The largest category in the benchmarking database is multifamily buildings (556); although this study focuses on office buildings, future studies will look into multifamily housing. The cross-referencing with the LEED project inventory resulted in the identification of 197 LEED-certified office buildings in both databases. The number of other LEED-certified building types did not have a sufficient match in the benchmarking database. The basic statistics for LEED-certified and non-LEED (other) buildings are summarized in table 2; the data includes the building year (median), total floor area, gross site and source EUI, and CO<sub>2</sub> intensities. The value of the relative standard error (RSE) was extracted from the U.S. Energy Information Administration’s website. According to EIA, the relative standard error is a measure of the reliability of precision in the survey statistics. The value for the relative standard error can be used to construct confidence intervals and to perform hypothesis tests by standard statistical methods [xviii].

**Table 2:** Summary of LEED and non-LEED office buildings in the DC benchmarking database. Median year of construction, total floor area.

Building Subset	N	Median Year	Floor Gross Area		Gross Site EUI			Gross Source EUI		
			ft <sup>2</sup>	(m <sup>2</sup> )	(kBtu/ft <sup>2</sup> )	kWh/m <sup>2</sup>	RES	(kBtu/ft <sup>2</sup> )	kWh/m <sup>2</sup>	RES
DC LEED Offices	197	1988	270,860	25,163	59.1	186.4	2.7%	158.9	501.3	2.7%
DC non-LEED Offices	284	1980	163,045	15,147	47.9	151.1	2.1%	124.6	393.1	2.1%

#### 3.1 DC buildings vs. national and regional buildings

It is important to compare the energy use pattern between DC buildings and national and regional office buildings. Table 3 lists the number of buildings, total gross floor area, gross site EUI, gross source EUI, and associated greenhouse gas (GHG) emissions intensity. The GHG intensity is calculated using fuel data combined with e-grid information about the regional electric grid [29]. The national reported median gross EUI for office buildings was reported by the U.S. ENERGY STAR Portfolio Manager in 2018; those EUI figures were based on 2018 CBECS survey data. Office buildings nationwide have a gross site and source EUI of 52.9 kBtu/ft<sup>2</sup> (166.9 kWh/m<sup>2</sup>) and 116.4 kBtu/ft<sup>2</sup> (367.2 kWh/m<sup>2</sup>), respectively. Comparing these national values, in Washington, D.C., office buildings use considerably more energy, both site and source energy.

**Table 3:** Summary of reported buildings in DC benchmarking database of office buildings and national office buildings extracted from CBECS 2018 survey data. The gross mean EUI is calculated using area weighting, and relative standard errors represent standard deviation in these weighted means, expressed as a percentage.

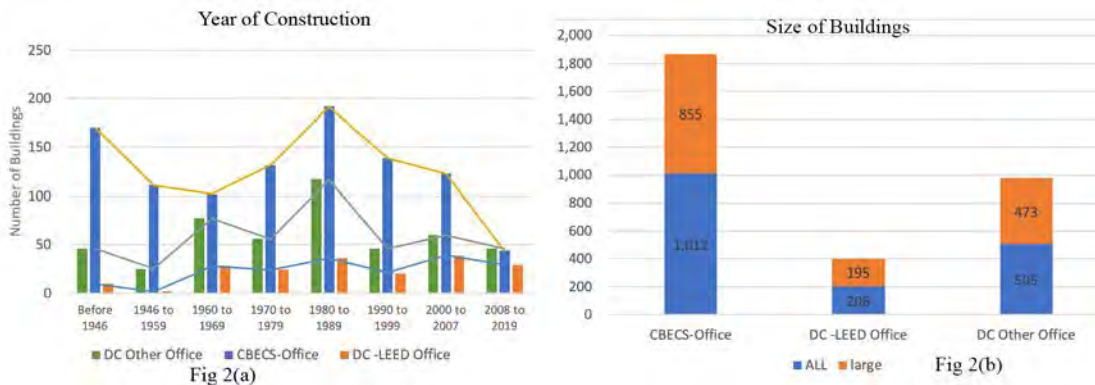
Building Type	N	Floor Gross Area		Building Age	Gross Site EUI		Gross Source EUI		CO <sub>2</sub> Intensity
		(ft <sup>2</sup> )	(m <sup>2</sup> )		(kBtu/ft <sup>2</sup> )	(kWh/m <sup>2</sup> )	(kBtu/ft <sup>2</sup> )	(kWh/m <sup>2</sup> )	
DC Offices	481	207,119	19,242	1982	58.4	184.2	155	488.9	5.7
National Offices	1,012,000	16,007,000	1,487,098	1975	52.9	166.9	116.4	367.2	5.4

We then dove deeper to understand which office building group/set had the highest energy use, and we found two important indicators of energy performance: building size and building age. Table 4 lists the properties from several U.S. building sets extracted from the 2018 CBECS survey data. These include all U.S. office buildings (CBECS-Off), large (>4645 m<sup>2</sup> or 50,000 ft<sup>2</sup>) U.S. office buildings (CBECS-larg-Off), all regional buildings (CBECS-reg), regional office buildings (CBECS-Reg-Off), and large regional office buildings (CBECS-Reg-larg-Off). Regional buildings are defined as being in the Mid-Atlantic census region and climate zones 4a and 4b. The CBECS data shows that office buildings tend to have higher site and source EUI than other buildings in the Mid-Atlantic region, at +/-35.7%. Larger office buildings have a slightly higher energy intensity compared to smaller ones, at +/-11.5%. It is important to note that regional (Mid-Atlantic) office building sets have higher site and source EUI than those of national building sets. DC office building sets have higher energy use intensity compared to the national median but lower energy use intensity than that of regional building sets.

**Table 4:** Breakdown and characteristics of LEED buildings

Building Sets	N	Gross Floor Area (ft <sup>2</sup> )	Gross Floor Area (m <sup>2</sup> )	Site GEUI (kBtu/ft <sup>2</sup> )	Area weight	Source EUI (kBtu/ft <sup>2</sup> )	Area weight
DC-LEED-off	197	270,860	25,163	53.9	59.1	148.5	158.9
CBECS-off	1,013	16,007,000,000	1,487,098,961	52.9	58.3	116.4	118.2
CBECS-larg-off	53	8,550,000	794,320	61.5	61.9	157.3	158.5
CBECS-reg	504	11,242,000,000	1,044,415,975	54.3	53.1	99.3	97.1
CBECS-reg-Off	94	2,965,000,000	275,457,513	73.7	77.8	154.2	155.6
CBECS-reg-larg-off	56	750,000	69,677	82.2	84.7	161.4 <sup>xix</sup>	165.8

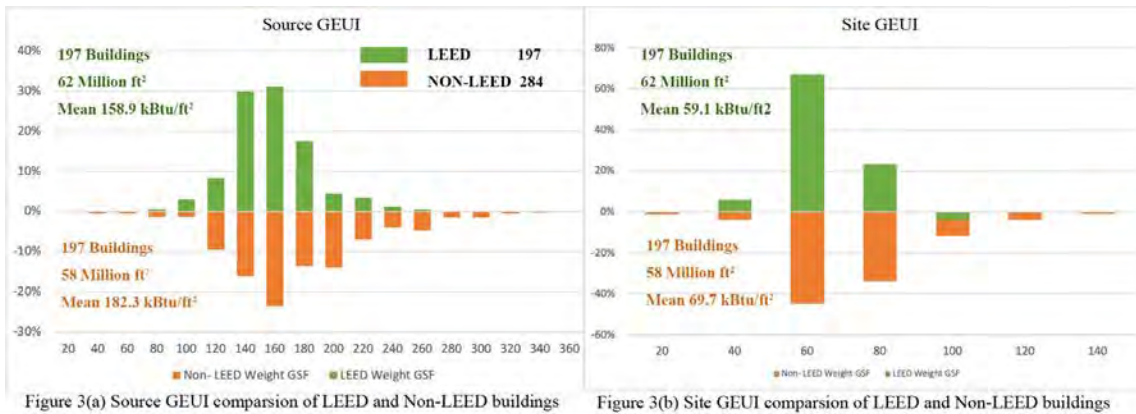
As for the age of buildings, figure 2(a) shows that DC LEED office buildings are newer than the average DC office buildings and national office buildings; 47% of DC LEED buildings were built after 1990 (new or renovated), whereas nationwide, only 30% of office buildings were built after 1990. It has been shown in CBECS 2003 and 2012 data that newer office buildings tend to have higher source EUI than older office buildings [xx]. Scofield also found from the NYC benchmarking report that older office buildings had lower site EUI than newer office buildings [Scofield 2013]. Figure 2(b) demonstrates that DC LEED offices have a larger building size; in this study, buildings with a floor area over 50,000 ft<sup>2</sup> were defined as larger buildings. Additionally, 95% of DC LEED office buildings are large buildings, while only 84% of office buildings nationwide are described as large buildings. Based on 2018 CBECS data, newer buildings tend to be larger than older buildings [xxi]. The two building characteristics when combined, a larger floor space and newer construction, contribute to the higher EUI of DC LEED office buildings, both in source and site energy.



**Figure 2:** Year of construction and buildings' size comparison

### 3.2 LEED vs. non-LEED

We first looked at 197 office buildings. In general, LEED office buildings do not exhibit reduced on-site or source energy consumption. Figure 3(a) represents a comparison of the distribution of source EUI for LEED buildings (in green) and non-LEED buildings (in orange). On the X-axis, the first bin represents the buildings with  $0 < \text{EUI} \leq 20 \text{ kBtu/ft}^2$ , and the last bin corresponds to source EUI  $\leq 360 \text{ kBtu/ft}^2$ . Figure (3a) shows an area-weighted histogram in which each bar represents the percentage of the total building gross floor area having site EUI that falls within a particular bin. For example, the first bin represents a floor area with  $0 \leq \text{EUI} \leq 20 \text{ kBtu/ft}^2$  while the 20th bin represents the range  $380 \leq \text{EUI} \leq 360 \text{ kBtu/ft}^2$ . The Y-axis indicates the value percent of the building floor areas that fall into a certain EUI bin. The green bars above the horizontal line present the area-weighted source EUI of LEED buildings ( $n=197$ ), and the orange bars below the horizontal line are the area-weighted source EUI of non-LEED buildings ( $n=284$ ). The graph demonstrates that the mean source GEUI for LEED offices is higher than that of non-LEED office buildings. Next, we further calculated the area-weighted means, which showed the area-weighted mean of source GEUI of LEED buildings as 17.13% higher than that of non-LEED office buildings. In order to verify the statistical significance of the two sets of different mean EUIs, the standard student t-test with two samples of equal variance [30] was performed, which produced a t-value of 4.65, corresponding to a two-sided p-value of 0.0000043. This means that there is more than a 99.9% chance that this difference is not accidental. Thus we concluded that in 2019, DC LEED offices, on average, used **17.13%** more source energy per unit area than did non-LEED offices. The same process has been repeated for site energy use, with the results shown in figure 3(b). DC LEED offices, on average, used **13.23%** more site energy per unit area than did DC non-LEED office buildings.



**Figure 3:** Source and site EUI comparison of DC LEED and non-LEED buildings (Author 2030)

#### 4.0 DISCUSSION

There are limited studies on the actual performance of sustainable buildings, and very few on LEED buildings due to unavailable performance data. To the author's knowledge, there are two studies that are similar to this project, which can be compared to the results of this study. Scofield (2013) studied 953 large New York City office buildings from the 2011 ENERGY STAR Energy Performance Rating database and found 21 matching LEED buildings. Regarding energy consumption and greenhouse gas emissions, he concluded that LEED buildings do not perform better when compared with non-LEED buildings. Moreover, he found the LEED Gold level outperformed other buildings by 20% while LEED Silver and LEED Certified office buildings underperformed compared to other office buildings [xxii]. Saldanha et al. (2016) cross-referenced LEED data with a New York City local law (LL84) that requires both city-owned and private buildings to report their actual annual energy and water use, and they identified 91 LEED buildings, including 66 offices and 25 multifamily buildings. The analysis results confirmed Scofield's study: they found NYC LEED office buildings performed slightly worse than non-LEED buildings, with an average source EUI that was about 7% higher. Similarly, LEED multifamily buildings performed worse, with an approximate average source EUI 30% over that of non-LEED buildings [xxiii]. Later, in 2018, Scofield compared Chicago LEED buildings against Chicago benchmarking data, and found that for offices, K-12 schools, and multifamily buildings, LEED buildings did not use less source energy than similar non-LEED buildings. On the contrary, LEED schools used 17% more source energy than did other non-LEED schools [xxiv]. The findings from our study on the District of Columbia office building performance are aligned with those of previous studies. A significant energy performance gap exists for LEED buildings across different regions and building types. An energy performance gap is the difference between the project (simulated) energy performance and the actual performance delivered in operation. This gap has been a known problem for a while [xxv]. Cali et al. (2016) studied refurbished German houses and found that the missed predicted saving varies between 41% and 117% [xxvi]. In the UK, a reported by the Building Performance Evaluation programme looked at 50 modern and green buildings and found that non-residential buildings were not meeting performance expectations. The reported showed supermarkets, offices, schools and health centers were normally using up to 3.4 times more energy than they were designed for and produced on average 3.8 times the predicated carbon emissions [xxvii].

Experts in the building industry often relate this gap to four potential causes: flaws in the construction caused by builders, overly complicated energy-saving technologies [],unpredicted occupant behavior [Cali et al. 2016], and inaccurate energy modeling [xxviii]. Recently, the focus has been on occupants' behavior and the reliability of energy modeling. Studies have been conducted to determine the factors causing the inaccuracy of the energy modeling. Knowledge of and experience with the energy model play an important role. It was found that modelers often underestimate operating hours, which could possibly be due to optimism bias or lack of experience in accounting for uncertainty [U.K Government]. To date, the large gap between predicted energy saving and actual performance has not been sufficiently addressed even after recognition of the issue. There is high potential harm in keeping such an issued unaddressed for long. If the assumption continues that all LEED buildings can perform at the level they are initially projected at, this misperception may lead to LEED buildings actually using more energy and emitting more carbon.

Unlike the study of NYC LEED buildings, in our DC study, LEED Gold office buildings do not perform better than non-LEED buildings. Instead, they have about 24% higher source energy consumption and 18% higher site energy than those of non-LEED office buildings. LEED-certified buildings use 24% higher source energy and 3% higher site energy than those of non-LEED buildings. LEED Silver buildings use 14% more source energy and 13% more site energy. LEED Platinum buildings use 19% more source energy and 22% more site energy. **Collectively, LEED office buildings, at all levels of certification, consume 17% more source energy and 13% more site energy compared to other non-LEED office buildings in the district (refer to table 6).**

**Table 6:** Gross EUI comparison between non-LEED buildings and LEED buildings at different levels

	Number	SITE GEUI	SOURCE GEUI	High(%) SITE GEUI	High(%) SOURCE GEUI
<b>NON-LEED</b>	284	47.9	124.6		
<b>LEED(all)</b>	197	54.3	145.9	13%	17%
<b>LEED(Certified)</b>	16	49.2	154.4	3%	24%
<b>LEED(Silver)</b>	55	54.2	142.4	13%	14%
<b>LEED(Gold)</b>	101	56.6	154.5	18%	24%
<b>LEED(Platinum)</b>	23	58.3	148.7	22%	19%

There are two potential explanations for the higher energy use. The first is regarding the buildings' operation. The operating hours can be longer in LEED buildings than those of non-LEED buildings, and the plug-load can be higher in LEED buildings than that in non-LEED buildings. The target or designed EUIs of those LEED buildings are not available on USGBC's website; therefore, it is impossible to conclude whether those buildings perform better or worse than they are designed for, which makes it even more difficult to understand what energy modeling parameters the design teams used in order to achieve LEED certification. The second cause for the higher energy use intensity could be directly contributed by the building system operations. If the actual operations of the buildings are the same as those modeled or predicted and the actual EUIs are in fact higher than the predicted EUIs, then the design building system is most likely not installed or operating as designed for or the equipment and system have malfunctioned. These types of problems have indeed happened previously.

Table 6 also illustrates that the results from measuring the source and site energy use are significantly different. For example, LEED *Certified*, LEED *Silver*, and LEED *Gold* buildings have higher EUIs compared to source energy. When only comparing site energy, LEED *Certified* buildings perform at almost the same level as non-LEED buildings, at only 3% higher. The site energy performance and saving do not directly translate into source energy use and saving due to the energy source differences. The U.S. EPA defines building source energy as including off-site energy losses [27]. In the United States, the primary energy used to produce and transmit electricity on average is more than three times that of the actual electricity delivered to the buildings [1]. In this sense, using source energy for building performance provides a more accurate assessment of building performance. The U.S. national average source-to-site energy conversion factor for electricity is 2.18; for natural gas it is 1.05 [xxxix]. Office buildings in the United States typically use a mix of fuels (natural gas and electricity), and newer buildings tend to have all-electricity use since moving towards 100% renewable electricity has been a global trend for the past five years [xxx]. This might be able to explain why the ratio between source and site energy at each LEED level is different. The overall weighted source and site EUIs are dependent on the mix within each building and the ratio of those buildings in corresponding levels.

Another important fact worth mentioning is the missing reported data. In the District of Columbia, there is a total of 643 LEED office buildings larger than 50,000 ft<sup>2</sup> that were certified by the end of 2019. Only 30% of those buildings reported their actual energy use in the year 2019; if the reported floor space is included, only 33% reported the actual performance data. Among the 643 buildings, 72 buildings received their certification in the year 2019, so they do not have enough operating annual data to report; therefore, they can be exempted. However, there are still 571 buildings that need to report their operating data. As mentioned at the beginning, all privately owned commercial buildings over 50,000 gross ft<sup>2</sup> are required to measure and report their energy use. Failure to do so can result in fines of up to \$100 per day for non-compliance. According to the data, non-significant incompliance stands at 66.6%, which is surprising and, at the same time, alarming. It indicates that more stringent benchmarking rules need to be put in place, and a more effective monitoring system needs to be implemented to make sure all buildings meet the requirements and actually report their operating data. Meanwhile, this also brings to attention a very important concern of the LEED building market: Why did those LEED buildings not report their actual energy operating data? Even some Platinum buildings did not report their data. **If we cannot hold the green building rating system accountable for its actual performance, how can we be certain that “green rated” buildings can help to reduce energy and carbon emissions? How can we be sure those green buildings do not harm our environment?**

## 5.0 CONCLUSION

The purpose of this study is not to criticize the LEED rating system but to instead encourage improvements to the system in order to meet DC's carbon neutrality goal. The LEED rating system, together with other green building rating systems, has proved to be a powerful market driver for sustainable design movement. There are many studies claiming that LEED buildings can contribute to an energy use reduction [xxxi], a carbon emissions reduction [xxxii], and greater human health benefits [xxxiii]. These all hinge on whether LEED buildings can perform at the level they were designed for. As illustrated in this study and previous ones, without a monitoring and reporting mechanism in place, LEED buildings' actual performance is questionable. To this extent, the U.S. LEED rating system can benefit from learning from other green building rating systems that include reporting and verification as prerequisite requirements. Zero

Energy certification (by the International Living Future Institute) and Passive House certification (by the Passive House Institute) requirements are based on a building's actual performance. The achievement of energy goals needs to be validated after a 12-month performance period. Zero Energy certification requires building owners to report annual site energy use data, and the Passive House Institute mandates annual source energy data for certification. The Chinese Three Star System also requires one year of operational data. Such requirements are useful tools to make sure the design, construction, and operation teams work towards the same goal. When achieving certification becomes the common goal among all stakeholders, internal conflict and split incentives can be avoided.

- <sup>i</sup> U.S Energy Information Administration. "Use of energy explained.". Accessed July 2, 2020. <https://www.eia.gov/energyexplained/use-of-energy/commercial-buildings-in-depth.php>
- <sup>ii</sup> Amiri, A., Ottelin, J., & Sorvari, J. (2019). Are LEED-certified buildings energy-efficient in practice?. *Sustainability*, 11(6), 1672.
- <sup>iii</sup> Wtop news. "Mid-Atlantic remains 'green building' leader . access June 10, 2020 <https://wtop.com/business-finance/2018/02/best-green-building-states-md-va-dc/>
- <sup>iv</sup> District Government, Department of Energy & Environment. "Final Benchmarking Rulemaking." Accessed July 6, 2020. <https://doee.dc.gov/node/412002>
- <sup>v</sup> District Government, Department of Energy & Environment. "About Benchmarking." Accessed July 6, 2020. <https://doee.dc.gov/node/572012>
- <sup>vi</sup> Scofield, J. H. (2013). Efficacy of LEED-certification in reducing energy consumption and greenhouse gas emission for large New York City office buildings. *Energy and Buildings*, 67, 517-524
- <sup>vii</sup> Energy Star Portfolio Manger. Accessed July 6, 2020. <https://www.energystar.gov/buildings/facility-owners-and-managers/existing-buildings/use-portfolio-manager>
- <sup>viii</sup> Department of Energy & Environment, DC gov. "Building benchmarking dataset.". Accessed July 6, 2020. <https://doee.dc.gov/publication/2017-building-benchmarking-dataset>
- <sup>ix</sup> Open Data DC. "Building Energy Benchmarks." Accessed 7/8, 2020. <https://opendata.dc.gov/datasets/building-energy-benchmarks>
- <sup>x</sup> U.S Energy Information Administration. "2018 CBECS Survey Data." Accessed July 7, 2020. <https://www.eia.gov/consumption/commercial/data/2018/index.php?view=consumption>
- <sup>xi</sup> Scofield, J. H. (2009). Do LEED-certified buildings save energy? Not really.... *Energy and Buildings*, 41(12), 1386-1390.
- <sup>xii</sup> Newsham, G. R., Mancini, S., & Birt, B. J. (2009). Do LEED-certified buildings save energy? *Energy and Buildings*, 41(8), 897-905.
- <sup>xiii</sup> ENERGY, S. (2012). ENERGY STAR® Portfolio Manager™: Data Trends: Benchmarking and Energy Savings. Accessed June 24, 2020. <https://www.energystar.gov/buildings/tools-and-resources/datatrends-benchmarking-and-energy-savings>
- <sup>xiv</sup> Scofield, J. H. (2013). Efficacy of LEED-certification in reducing energy consumption and greenhouse gas emission for large New York City office buildings. *Energy and Buildings*, 67, 517-524.
- <sup>xv</sup> Scofield, J. H., & Doane, J. (2018). Energy performance of LEED-certified buildings from 2015 Chicago benchmarking data. *Energy and Buildings*, 174, 402-413.
- <sup>xvi</sup> Scofield, J. H., & Oberlin, O. (2009, August). A re-examination of the NBI LEED building energy consumption study. In International energy program evaluation conference, Portland, OR.
- <sup>xvii</sup> LEED Project, accessed June 10, 2020. <https://www.usgbc.org/projects?Country=%5B%22United+States%22%5D&State=%5B%22District+of+Columbia%22%5D&Rating+System=%5B%22Core+and+Shell%22%2C%22New+Construction%22%2C%22Existing+Buildings%22%2C%22Interiors+-+Existing+Buildings%22%5D>
- <sup>xviii</sup> U.S Energy Information Administration. "What is RSE." Accessed June 29, 2020. <https://www.eia.gov/consumption/commercial/data/what-is-an-rse.php>
- <sup>xix</sup> <https://doee.dc.gov/page/energy-benchmarking-disclosure>
- <sup>xx</sup> Scofield, J. H., & Oberlin, O. (2009, August). A re-examination of the NBI LEED building energy consumption study. In International energy program evaluation conference, Portland, OR.
- <sup>xxi</sup> U.S. Energy Information Administration. "Average size of new commercial buildings in United States continue to grow." Accessed July 3, 2020. <https://www.eia.gov/todayinenergy/detail.php?id=21152>
- <sup>xxii</sup> Scofield, J. H. (2013). Efficacy of LEED-certification in reducing energy consumption and greenhouse gas emission for large New York City office buildings. *Energy and Buildings*, 67, 517-524.
- <sup>xxiii</sup> Saldanha, C. M., & O'Brien, S. M. (2016). A study of energy use, New York LEED-certified buildings. *Proceedings of SimBuild*, 6(1).
- <sup>xxiv</sup> Scofield, J. H., & Doane, J. (2018). Energy performance of LEED-certified buildings from 2015 Chicago benchmarking data. *Energy and Buildings*, 174, 402-413.
- <sup>xxv</sup> De Wilde, P. (2014). The gap between predicted and measured energy performance of buildings: A framework for investigation. *Automation in construction*, 41, 40-49.
- <sup>xxvi</sup> Cali, D., Osterhage, T., Streblov, R., & Müller, D. (2016). Energy performance gap in refurbished German dwellings: Lesson learned from a field test. *Energy and buildings*, 127, 1146-1158.
- <sup>xxvii</sup> U.K Government. "Building performance evaluation programme: findings from non-domestic projects." Accessed July 5, 2020. <https://www.gov.uk/government/publications/low-carbon-buildings-best-practices-and-what-to-avoid>
- <sup>xxviii</sup> <https://e360.yale.edu/features/why-dont-green-buildings-live-up-to-hype-on-energy-efficiency>
- <sup>xxix</sup> Energy Star. "What are the site-to source conversiaon factors?" accessed July 8, 2020. <https://portfoliomanager.zendesk.com/hc/en-us/articles/216670148-What-are-the-Site-to-Source-Conversion-Factors->
- <sup>xxx</sup> Hohmeyer, O. H., & Bohm, S. (2015). Trends toward 100% renewable electricity supply in Germany and Europe: a paradigm shift in energy policies. *Wiley Interdisciplinary Reviews: Energy and Environment*, 4(1), 74-97.
- <sup>xxxi</sup> Newsham, G. R., Mancini, S., & Birt, B. J. (2009). Do LEED-certified buildings save energy? *Energy and Buildings*, 41(8), 897-905.
- <sup>xxxii</sup> MacNaughton, P., Cao, X., Buonocore, J., Cedeno-Laurent, J., Spengler, J., Bernstein, A., & Allen, J. (2018). Energy savings, emission reductions, and health co-benefits of the green building movement. *Journal of Exposure Science & Environmental Epidemiology*, 28(4), 307-318.
- <sup>xxxiii</sup> Allen, Joseph G., Piers MacNaughton, Jose Guillermo Cedeno Laurent, Skye S. Flanigan, Erika Sita Eitland, and John D. Spengler. "Green buildings and health." *Current Environmental Health Reports* 2, no. 3 (2015): 250-258.



# From Nano to Building Scale: Design and Fabrication of Acoustical Diffusers based on Quasi-crystalline Atomic Structure

Rima Ajlouni<sup>1</sup>

<sup>1</sup>University of Utah, Salt Lake City, UT

**ABSTRACT:** The discovery of quasi-crystalline atomic order in the solid-state physics has challenged decades of foundational knowledge in crystallography. The atoms in these novel quasi-crystalline structures are not arranged according to regularly spaced intervals similar to traditional crystals, instead they exhibit a long-range translational order that is not periodic. Three decades after their initial discovery, hundreds of quasicrystals have been reported; exposing a wealth of untapped potentials. Because of their unique isotropic, self-similar and hierarchical order, quasi-crystalline structures offer unique opportunities for addressing questions related to their acoustical behavior. In 2018, Ajlouni demonstrated that the quasi-periodic formations have the ability to diffuse and orchestrate the flow of sound energy; eliminating a major limitation with the repeating logic of traditional periodic diffusers. A major limitation with periodically arranged diffusers, is that they create repetitive energy loops that significantly reduce their ability to uniformly disperse sound energy. The goal of this paper is to introduce a generalized structural method for designing surfaces with quasi-periodic geometry for architectural acoustics. The paper also explores two methods for the fabrication of these surfaces using ceramic casting and vacuum forming processes. By utilizing the qualities of quasi-periodic structures, this research hopes to inspire a new wave of acoustical surface diffusers that allow designers to encode a wide range of acoustical behavioral properties without sacrificing the aesthetic qualities.

**KEYWORDS:** quasi-crystalline, design and fabrication, acoustical diffusers, atomic structure

## INTRODUCTION

The discovery of quasicrystals in the 1980s (Shechtman et al. 1984) has severely shaken the bedrock of theoretical solid-state science. This new state of matter exhibits forbidden symmetries which were thought to be impossible for the crystalline matter in the classical crystallography. The atoms in these complicated structures are not arranged according to regularly spaced intervals similar to traditional crystals, rather they exhibit a complicated long-range translational order that is not periodic. Three decades after the initial discovery hundreds of quasicrystals have been reported in metallic alloys and polymers. However, a full understanding of the long-range quasi-periodic structures of quasicrystals still poses many challenges. To date, scientists rely on complicated and abstract mathematics to construct these puzzling structures (i.e. inflation, deflation, substitution, matching overlapping, projecting, etc.), which mostly operate beyond the human perception. Therefore, for the benefit of the wider scientific community and to make these formations accessible beyond the fields of crystallography and material science, it is imperative that alternative models that operate within the real physical (Euclidean) space be proposed; eliminating a major roadblock for many researchers in non-technical fields.

Surprisingly, eight centuries before their discovery in modern science, ancient craftsmen had created patterns with quasi-periodic formations (Makovicky1992; Makovicky, Rull P´erez, and Fenoll Hach-Al 1998; Makovicky and Makovicky 2011; Rigby 2005; Lu, and Steinhardt, 2007; Saltzman, 2008). By using the most primitive tools; “a compass and a straightedge”, a creative multi-level proportional method was used to construct a wide range of ancient quasi-periodic ornamental patterns. My investigations into ancient geometry brought to light a new way of looking at the structure of quasicrystals (Ajlouni 2011; 2012; 2013; 2017a; 2017b; 2018a; 2018b; 2019), offering the first simple multi-level hierarchical framework model that is able to explain the long-range order of quasicrystals. The use of simple proportional system presents a paradigm shift in the way scientists understand these formations and provides a new path for investigating their long-range order. Moreover, this new alternative model operates within the real physical (Euclidean) space; eliminating a major roadblock for many researchers outside the field of crystallography and material science. Because of the unique logic and proportional properties, these quasi-crystalline formations can be ideally suited for many contemporary applications in art and architecture; providing a rich source of symmetries for articulating new forms, patterns and structures. It is the goal of this paper to present a generalized theoretical approach for creating quasi-periodic structures without relying on abstract or complicated mathematics. Access to a wide range and customizable quasi-period symmetries offers golden opportunities for investigating new solutions, systems and



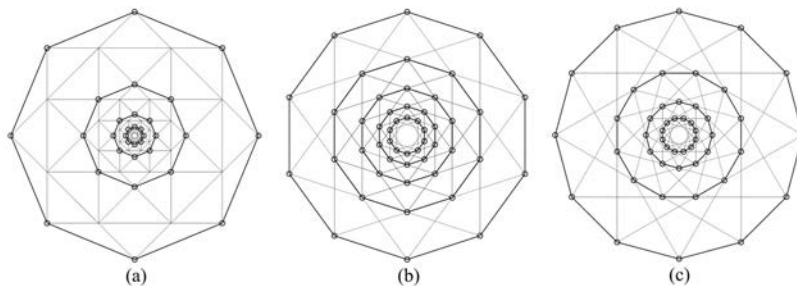
processes for architectural applications. As rule-based systems, quasi-periodic formations can be parametrically tailored to encode behavioral attributes by utilizing basic digital design and fabrication processes. While, the range of possible applications of quasi-periodic formations in design can be wide, this paper specifically addresses the application of quasi-periodic formations for designing diffusers for Architectural acoustics. Traditionally, sound diffusers are designed based on either periodic or random systems. On one hand, while periodic patterns are easy to manufacture, they can produce looped and bundled reflections; significantly compromising their performance. On the other hand, while designing diffusers based on random system can mediate such limitation, it is however very challenging to manufacture unlimited number of units as well as impossible to visually encode. Quasi-periodic formations can mediate both limitations. These formations can encode a wide range of non-periodic symmetries that can be expanded infinitely without repeating their formations. At the same time, the manufacturing of these formations requires the fabrication of few units only, making it a perfect fit for designing optimized diffusers. Moreover, the hierarchal self-similarity attributes of quasi-periodic formations allow designers to encode surface designs in different scales for reflecting a wide range of sound frequencies.

In the following sections a generalized structural method for designing non-periodic geometry using available graphic tools is introduced. The presented approach allows designers and scientists to encode a wide range of behavioral parameters for optimizing diffusers for architectural acoustics. Moreover, this paper explores two methods of fabrication of these surfaces using ceramic slip casting and plastic vacuum forming processes.

## 1.0 STRUCTURAL METHOD

### 1.1. The underlying relational logic

Generating the quasi-periodic designs depends primarily on the construction of the underlying quasi-periodic relational networks that are responsible for controlling the type of symmetry. The generating process does not follow discrete measurements, angles, or prescribed distances, instead it utilizes the inherent relationships within the underlying relational logic; allowing a higher level of organization to happen intuitively. The underlying relational networks are hierarchical in nature and multi-generational, in which every hierarchy is built on the previous one. To demonstrate this principle, (Fig. 1) shows three examples of 8-fold (Fig 1a) , 10-fold (Fig. 1b) and 12-fold (Fig. 1c) underlying relational networks of the first order hierarchy. These nested polygonal networks can be constructed easily by drawing rotational lines connecting any points on the initial polygon, which produces a smaller scale internal polygon with a fixed ratio. By examining the three constructed networks we find that, if we denote the radius of any poly-gram by  $r$  and the next larger radius by  $r+1$ , then the ratio of  $(r+1)/r$  is equal to the irrational factor of  $\sqrt{2+1}$  for network a, the golden ratio  $(1+\sqrt{5})/2$  for network b and the square irrational factor of  $\sqrt{(2+\sqrt{3})}$  for network c. It is important to point out that each of the three networks in Fig 1 , represents only one option of many different nested network combinations that can be constructed using this principle.



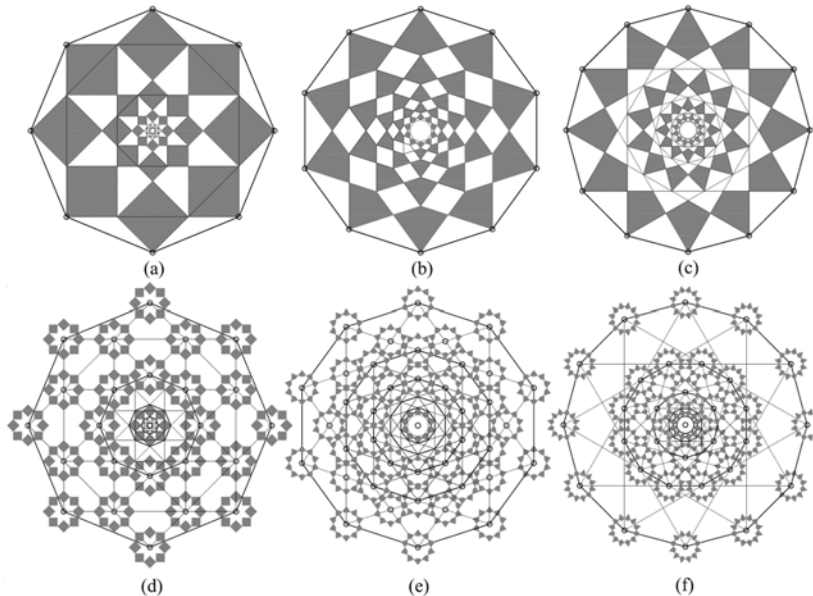
**Figure 1:** Three examples of underlying relational networks, 8-fold (Fig 1a), 10-fold (Fig. 1b) and 12-fold (Fig. 1c) of the first order hierarchy. Source: (Ajlouni 2021)

### 1.2. Self-similarity principle

The construction process for the quasi-periodic designs depends primarily on two components. The underlying relational logic which control the type of symmetry, as well as constitutes the structural grid for organizing the whole system. The second component is a limited number of repeated (seed) units that dictate the design parameters for the system. The size of the repeated (seed) units is relational to the whole system and derived from the progression of nested poly-grams as shown in Figs 2a- 2c. Figs. 2d-2f, show examples of three different sizes of the seed units and their distribution based on the underlying quasi-periodic networks.

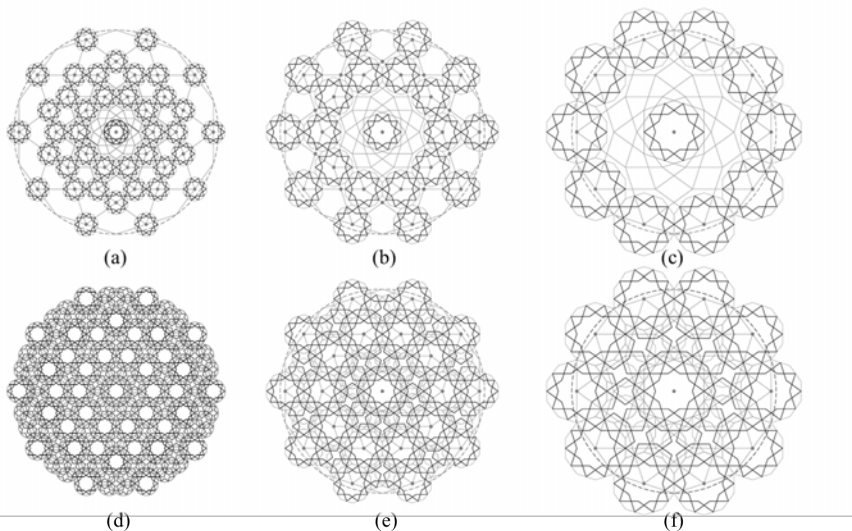
As shown in these systems, the underlying relational logic (Fig. 1) provides the coordinates for mapping the locations of the repeated (seed) units (Fig 2). While periodic designs rely on a periodic underlying structure for mapping the distribution of the (seed) units, the quasi-periodic designs rely on a quasi-periodic grid for guiding the distribution of the (seed) units. Accordingly, the key to resolving the quasi-periodic symmetries lies in understanding the mathematical qualities of the underlying relational quasi-periodic networks and their generating logic. On the other hand, the internal

design of the repeated (seed) units is responsible for deriving the different design variations of the system. By manipulating these two parameters, a wide range of design variations can be possible. For example, changing the internal network design for the repeated (seed) units will result in many design variations while keeping the type of symmetry. Alternatively, manipulating the underlying relational logic, can result in changing the symmetry but keeping the same design.



**Figure 2:** The distribution of three types and sizes of seed units 8-fold, 10-fold and 12-fold symmetries based on the quasi-periodic underlying grid. Source: (Ajlouni 2021)

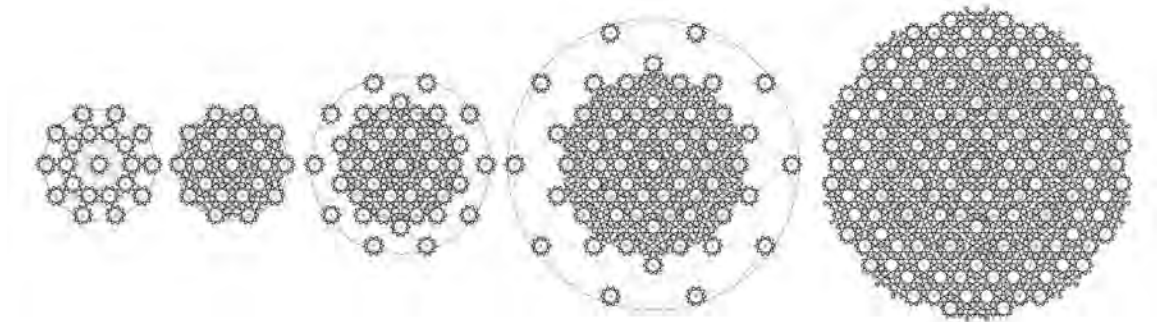
One of the most interesting properties of the quasi-periodic symmetries is the fact that they are self-similar. This property is derived from the hierarchical nature of these systems. In the case that the internal line design of the repeated (seed) units mirrors the design of the nested poly-gram network, a perfect self-similar design can be constructed, in which the same pattern occurs at different scales. For example, Fig.3 shows three levels of 10-fold hierarchical designs of the first order. Each size of the three scales are proportionally derived from the same underlying relational network



**Figure 3:** Three levels of 10-fold hierarchical designs of the first order. Source: (Ajlouni 2021)

As shown in Figs. 3a-3c, the locations of the repeated (seed) units are mapped by the intersection points of the underlying nested deca-grams, resulting in perfect proportion that allow all seed units to meet edge-to-edge without overlap or gaps. In this system, the designers have the freedom to extend the connecting formations between the main

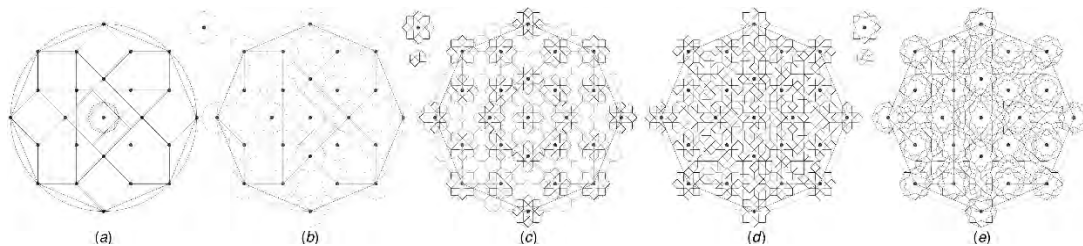
seed units without affecting the underlying symmetry. Such freedom allows for a wide range of possibilities to emerge in the internal design of the seed units, which can be utilized to customize the design of the diffusers. Expanding this hierarchical network is achieved by building a progression of nested poly-grams, in which, every hierarchy is proportionally built on the previous one; resulting in a very proportionally controlled self-similar relational network (see Fig. 4).



**Figure 4:** Building a progression of nested poly-grams, in which, every hierarchy is proportionally built on the previous one. Source: (Ajlouni 2021)

### 1.3. Constructing the first hierarchy

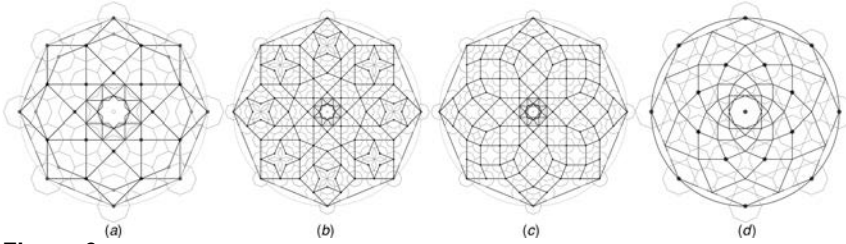
The process of constructing the infinite quasi-periodic pattern is based on building a multi-level hierarchical system, in which, each hierarchy is built on the previous one. Figure 5 demonstrates the process of constructing the first hierarchy of two different 8-fold quasi-periodic designs using the same underlying network. The process starts by constructing the structural network of the first hierarchy. In this process, a framework of nested octa-grams is constructed, in which, every nested octa-gram is built on the previous level. The first octa-gram is constructed by drawing a polar array of lines through connecting points of equal distances on the initial octagon. In this multi-level system, the higher-level octa-gram, in turns, defines a smaller scale internal octagon, which forms a new base for repeating the same process (Fig. 5a). The number of cycles can vary and depends on the desired level of pattern complexity and details. This progression of nested octa-grams serves a critical role in maintaining a relational aspect ratio between the different levels, which is the key to resolving the quasi-periodic symmetries. In this tightly controlled proportional system, the size of the smallest octagon determines the size of the repeating (seed) units, allowing them to fit precisely in their place. By mapping the locations of the (seed) polygon to the intersection points of the structural quasi-periodic grid, a distribution map of the generalized seed polygons is created (Fig. 5b). By manipulating the internal designs of the (seed) polygon, designers can create multiple design solutions without affecting the quasi-period symmetry. Figures 5d and 5e show two different design variations of the first hierarchy using the same quasi-periodic structural grid.



**Figure 5:** The process of constructing the first hierarchy of two different 8-fold quasi-periodic designs. Source: (Ajlouni 2021)

This simple process allows for a creative proportional system to emerge between all parts of the network making it a great method for designers to create a vast variety of underlying networks, which can be used to guide the distribution of the (seed) units. In this system, the connecting formations between the main (seed) units can take multiple forms, allowing a flexible design space for creative patterns to emerge. By manipulating the internal design of the (seed) units and their connecting formations, a vast variety of new and creative designs can emerge without affecting the quasi-periodic symmetry.

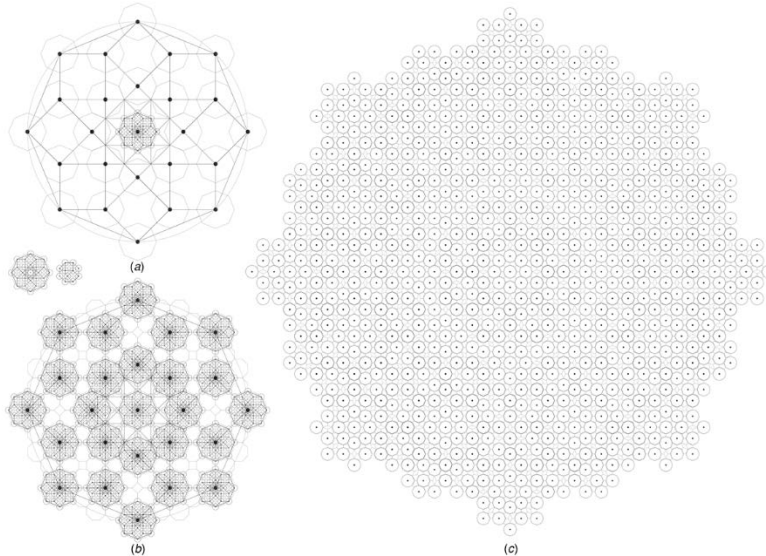
Variety of design solutions for constructing the underlying relational quasi-periodic networks can be achieved following a similar process. Figure 6 shows four different variations of these networks, three of which, (Figs. 6a, 6b and 6c) have been used to construct a variety of ancient patterns. Figure 6d shows a new variation of the quasi-periodic network, constructed by the author. In each case, a progression of nested poly-grams are constructed by drawing arrays of lines connecting different intersection points along the initial polygon. This process can produce different designs for the relational grids; allowing a variety of proportional systems to emerge. By mapping the center of the seed polygons to the intersection points of the quasi-periodic grids, an array of generalized polygonal maps are created. These maps serve as blue prints for constructing a vast variety of quasi-periodic design solutions.



**Figure 6:** (a) The quasi-periodic network used for constructing the pattern on the walls of the Hall of the Ambassadors, Alhambra (1354). (b) The quasi-periodic network used for constructing a pattern surrounding the Patio of Virgins in the Alcazar, Seville, (1364-1366). (c) The quasi-periodic network used for constructing one of the patterns surrounding the Patio of Virgins in the Alcazar, Seville, (1364-1366), and the pattern on the side walls of the Mirador de Lindaraja, the Hall of the Two Sisters, Alhambra (1354-1359). (d) Quasi-periodic network constructed by the author. Source: (Ajlouni 2021)

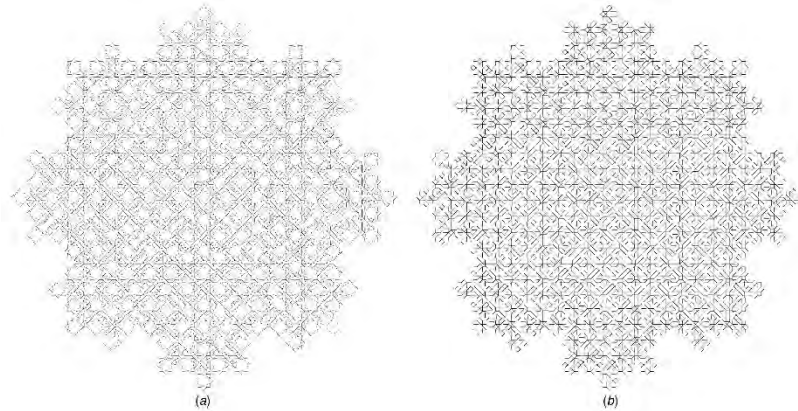
### 1.4. Growing the infinite empire

Constructing the second hierarchy of the quasi-periodic formations follows a similar path, in which, the final constructed cluster of the first hierarchy (Fig. 5) acts as a (seed) unit for constructing the second hierarchy (Fig. 7a). A new generation of the nested octa-grams is constructed in relation to the size of the new (seed) cluster forming a larger underlying relational map for guiding the distribution of the new generation of the (seed) clusters (Fig. 7b). Figure 7c shows the generalized polygonal grid of the second hierarchy, which can be used to house a vast array of design solutions while keeping the same symmetry. Figure 8 shows two different design solutions of the second hierarchy using the two seed designs in Figures 5d and 5e.



**Figure 7:** (a) and (b) A new generation of the quasi-periodic structural grid is constructed in relation to the size of the new (seed) cluster forming a larger underlying relational map for guiding the distribution of the new generation of the (seed) clusters. (c) The generalized polygonal map of the second hierarchy, which can be used to house a vast array of design solution while keeping the same symmetry. Source: (Ajlouni 2021)

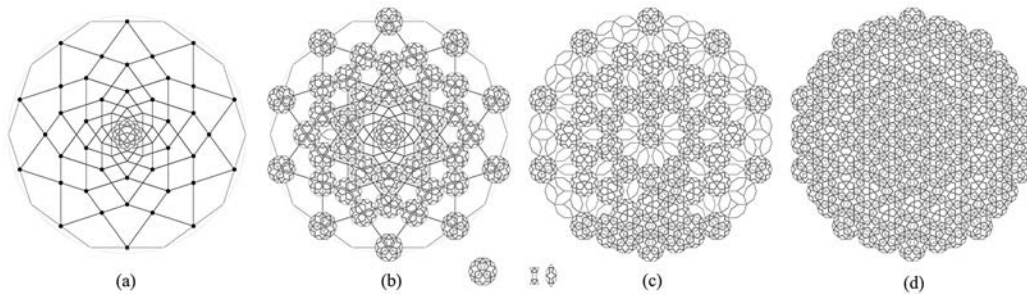
Following the same process, constructing the infinite 8-fold quasi-periodic empire requires building an infinite hierarchies of levels, in which every hierarchy is built on the previous one. In this way quasi-periodic patterns can grow ad infinitum while constantly changing its formation.



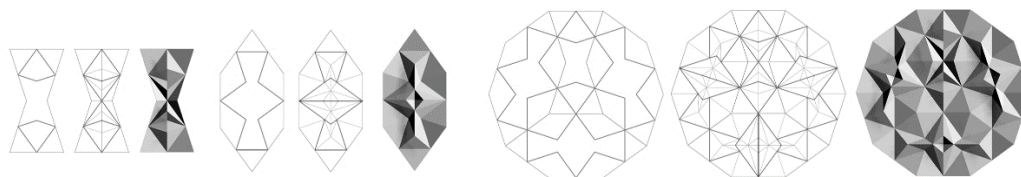
**Figure 8:** Two different designs solutions of the second hierarchy using the two seed designs in Figures 5d and 5e. Source: (Ajlouni 2021)

### 1.5. Surface profile

The design process of the quasi-periodic surface profile depends primarily on the encoded sound properties. Designers can calculate the size, depth, angle of the profile to optimise the reflection qualities of the diffuser. For example, Figure 9 shows the construction of the first hierarchy order of 10-fold quasi-periodic pattern. In this case the infinite pattern can be constructed by fabricating only two units. Figure 10 demonstrate one possible surface profile constructed by building the two units and their combinations based on the general map in Figure 9.



**Figure 9:** The construction of the first hierarchy order of 10-fold quasi-periodic pattern. Source: (Ajlouni 2021)



**Figure 9:** One possible surface profile constructed by building two units and their combinations. Source: (Ajlouni 2021)

### 2.0. FABRICATION METHODS

One of the main advantages for using quasi-periodic patterns to design sound diffusers is that it requires only the fabrication of few units to construct the infinite empire, which makes it easy to manufacture and produce. Recently, digital fabrication have emerged as a new paradigm for creative exploration and research, allowing the integration of the digital tools with traditional methods for the construction of very intricate geometry with relative ease. This paper presents two approaches for the fabrication of quasi-periodic surface diffusers; ceramic slip casting and vacuum forming.



## 2.1. Ceramic casting

To demonstrate the process of ceramic casting, this paper utilizes the fabrication of the quasi-periodic surface design shown in Figure 9. The process for casting the infinite quasi-periodic surface requires casting two units. The process is demonstrated in the next 5 steps (Fig. 10).



**Figure 10:** Slip casting process of the quasi-periodic units. Source: (Ajlouni 2021)

### 1: Machining the master mold (negative)

The slip casting process starts by designing the two negative master molds using Rhinoceros 3D software. The two master molds are designed with sloped edges to allow for easier release of the rubber castings. All molds were machined with a 3-axis CNC mill using a medium density polyurethane foam. The molds can be sanded to smooth-out any unwanted tool textures or sharp edges.

### 2: Casting the rubber mold (positive)

The second step requires casting the positive rubber molds using the machined molds. The casting process utilized Polytek polyurethane liquid rubber (Poly 74-20 A~20 hardness). The process requires the calculation of the volume of the negative machined mold (enclosure) to measure the amount of rubber needed. The rubber requires seven hours to cure before de-molding. It is always a good practice to apply few coat of mold release before casting the rubber.

### 3: Casting the plaster mold (negative)

The third step requires casting the negative plaster molds out of the positive rubber units. The plaster molds can be de-molded within one hour. The plaster molds need to be bone dry before using them for slip casing. It is also important for the plaster molds to have thick walls to allow the mold to absorb the moisture from the liquid clay. Also, dusting the plaster mold with Talc will allow an easier release of the leather hard clay.

### 4: Casting the final ceramic surface units (positive)

Slip casting provides an excellent process for the fabrication of complex and intricate geometry, allowing the depiction of all surface details including fine textures. The process utilizes a liquid clay (slip) to be poured into the plaster molds; allowing the formation of a layer of clay on the inside walls of the mold. When reaching the desired ceramic thickness, the excess slip is then poured out of the mold. The clay is left to dry to a leather form before it can be de-molded from the plaster molds

### 5: Firing and glazing

The ceramic castings are then left to dry completely before firing them in ceramic kilns. These units can be glazed or not depending on their applications.

## 2.2. Vacuum forming

The first step of the vacuum forming process requires machining the positive molds which was be used for the plastic vacuum forming. The molds were designed using Rhinoceros 3D software and were machined with a 3-axis CNC mill using poplar wood. The machined positive mold can be sanded to smooth-out any unwanted tool textures or sharp edges ( Fig. 11). For the vacuum forming process, this research utilized CENTROFORM LV 1827 vacuum forming machine. After experimenting with different plastic sheets and thickness, the research team decided on using black ABS sheets with thickness of 0.040 inch. One of the main challenges with the forming process was capturing the curvature of the inside valleys of the vacuumed shapes. After some explorations, we decided to drill few holes in those valleys to allow the vacuum to accurately register the detailed shape.



**Figure 11:** Vacuum forming of two quasi-periodic surface units (school of architecture, University of Utah). Source: (Ajlouni & Feltovich 2021).



## CONCLUSION

In conclusion, this paper presented a generalized approach that can be used to design a wide range of quasi-periodic formations for developing architectural sound diffusers. Four qualities make the use of non-periodic systems more advantageous than using periodic or random systems. The first advantage, is that the quasi-periodic diffusers allow the sound energy to be reflected evenly, mediating the limitations of period diffusers, which produce bundled and looped reflections. The second advantage, is that the manufacturing process of quasi-periodic diffusers requires the fabrication of limited number of units, which mediate the limitation with manufacturing random systems that require unlimited units to be fabricated. The third advantage of using the quasi-periodic systems, is that these patterns are self-similar, which allows the designers to encode multiple scales and sizes; making them very effective when responding to a wide range of sound frequencies. The fourth advantage, is that quasi-periodic-based diffusers allow designers to encode a wide range of aesthetic qualities, making them much more attractive and visually appealing than existing periodic or random designs.

## ACKNOWLEDGEMENTS

This research was supported, in part, by the 2019 Scholarship Incentive Program (SIP) from the University of Utah . I also would like to acknowledge my research assistant Lucia Feltovich for her effort in the vacuum forming fabrication.

## REFERENCES

- Ajlouni, R. 2013. *Octagon-based quasi-crystalline formations in Islamic architecture*. In *Aperiodic Crystals*, ed. Siegbert Schmid, Ray L. Withers and Ron Lifshitz, 49-58. Amsterdam: Springer.
- Ajlouni, R. 2011. *A long-range hierarchical clustering model for constructing perfect quasi-crystalline formations*. *Philosophical Magazine* 91:2728-2738 <https://doi.org/10.1080/14786435.2010.532515>
- Ajlouni, R. 2012. *The global long-range order of quasi-periodic patterns in Islamic architecture*. *Acta Crystallographica Section A*. 68: 235-243. <https://doi.org/10.1107/S010876731104774X>
- Ajlouni, R. 2017a. *Simulation of sound diffusion patterns of fractal-based surface profiles*. In *ACADIA 2017: DISCIPLINES & DISRUPTION*, Proceedings of the 37th Annual Conference of the Association for Computer Aided Design in Architecture (ACADIA) ISBN 978-0-692-96506-1. Cambridge, MA 2-4 November, 2017, pp. 52-61.
- Ajlouni, R. 2017b. *An ancient rule for constructing dodecagonal quasi-periodic formations*. *Journal of Physics: Conference Series*. Volume 809 (1): <http://iopscience.iop.org/article/10.1088/1742-6596/809/1/012028/pdf>
- Ajlouni, R. 2018a. *The relational logic behind the hierarchical geometry in Islamic art*. In *Proceedings of ISSC 2018: Logics of Image: Visual Learning, Logic and Philosophy of Form in East and West*, Kolymbari, Crete, 11-18.
- Ajlouni, R. 2018b. *Quasi-periodic Geometry for Architectural Acoustics*. *Enquiry: A Journal for Architectural Research* 15 (1): 42-61.
- Ajlouni, R. 2019, *A surface-stacking structural model for icosahedral quasicrystals*. *Struct Chem* 30, 2279–2288. <https://doi.org/10.1007/s11224-019-01413-x>.
- Lu, P. and Steinhardt, P. J. 2007. *Decagonal and Quasi-Crystalline Tilings in Medieval Islamic Architecture*, *Science* 315: 1106-1110.
- Makovicky, E. 1992. *800-Year-Old Pentagonal Tiling from Maragha, Iran, and the New Varieties of a Periodic Tiling it Inspired*. in *Fivefold Symmetry*, ed. I. Hargittai (Singapore: World Scientific Publishing Co Pte Ltd, 67–86.
- Makovicky, E. and Makovicky, N. 2011. *The First Find of Dodecagonal Quasiperiodic Tiling in Historical Islamic Architecture*, *J. Appl. Cryst.* 44: 569-573.
- Makovicky, M. Rull P´erez, F. and Fenoll Hach-Al’i, P. 1998. *Decagonal Patterns in the Islamic Ornamental art of Spain and Morocco*, *Boletín Sociedad Española Mineralogía* 21: 107–127.
- Rigby, J. 2005. *A Turkish Interlacing Pattern and the Golden Ratio*, *Math. School*, 34: 16–24.
- Saltzman, P. W. 2008. *Quasi-Periodicity in Islamic Ornamental Design*. in *Nexus VII: Architecture and Mathematics Conference Series*, ed. Kim Williams (Torino: Kim Williams Books), 153–168.
- Shechtman, D., Blech, I. Gratias, D. and Cahn, J.W. 1984. *Metallic phase with long range orientational order and no translation symmetry*. *Phys. Rev. Lett.* 53(20): 951-1954. <https://doi.org/10.1103/PhysRevLett.53.1951>





# CULTURAL PERFORMANCES



# Sacrality, Space + Self: Critical Explorations of Meaning, Relationship + Resonance in Islamic Architecture

Nooshin Esmaeili<sup>1</sup>, Brian R. Sinclair<sup>1,2</sup>

<sup>1</sup>University of Calgary, Canada

<sup>2</sup>sinclairstudio inc., Calgary, Canada

**ABSTRACT:** Architecture is not only about creating spaces but more importantly addresses the quality of place and users' experience. With certain intentions, the architect deploys form and choreographs the movement through space, harnessing various elements collectively to tell a story. However, the message is conveyed to the users successfully only when the senses are simultaneously addressed, and a relationship is created between the individual and the environment. This results in blending one's internal space with the experience of the world beyond, identified as "quality" (Zumthor 2006) or "life-enhancing" (Pallasmaa 2012) architecture. In this paper, the authors are particularly curious about the spiritual experience of Islamic architecture. Their research acknowledges the distinction between spirituality and religiosity, underscoring that transcendental qualities in space can be grasped by all people regardless of beliefs. The goal is not to say that all spaces are equal and that all buildings should provide an enhanced spiritual experience, but to examine those that have the requisite qualities so that designers can seek a better understanding of the concept of 'quality' space. To do so, this research serves to identify key criteria necessary in the exploration of spirituality as well as uncovering the importance of meaning, relationship, and resonance, more specifically, in Islamic architecture - together creating a transcendental encounter. Architecture is more than seeing. Transformative places can be felt with the heart and spaces can be experienced without sight. Sacred spaces in Islamic architecture are often intended to detach us from our materialistic lifestyle and unite us with our genuine internal state. Transcendental spaces aim to lift us into a realm beyond our logical mind (perceptual) to the inner space of the soul or the numinous place (Otto 1970). This special feeling or spark is universal and not solely limited to sacred architecture. The present paper explores a set of criteria developed by the authors and considers their importance in delivering transcendental architecture. For the second part of this research, which lies beyond the immediate scope of this paper, the research examines the application of the developed criteria in various high profile case studies for understanding the art of orchestrating architectural features and elements in delivering the notion of "flow" and "unity" in Islamic architecture through the lens of Sufism. This research interrogates the status-quo through a literature review and considers several well-known case studies known for their transformative qualities and a heightened sense of place. The research, in a larger sense, evokes logical argumentation to develop a conceptual framework including initial design parameters/guidelines, targeted to begin the journey of developing a conceptual framework including initial design parameters/guidelines, targeted to designers and architects aspiring to elevate their design potency and spatial mastery to reach transcendental and performative ends. The authors, at the current junction, seek a balance between provocation/speculation and rigor/discipline along with the identification of connections between several vital elements - sacrality, self, space, and wellbeing. In this paper, the authors conclude that many of the illuminations and recommendations revealed through this research find applicability in religious and spiritual traditions beyond the confines of Islam.

**KEYWORDS:** Sacred architecture, Islamic architecture, transcendental space, Sufism, systems thinking, complexity, design

## INTRODUCTION

"Your sacred space is where you can find yourself over and over again." Joseph Campbell

Architecture is more than aesthetics or providing shelter, welfare, and a safe environment for the users. Architects have long questioned the relationship between people and space, driven by an interest to understand how the interior and exterior design of buildings influence humans' performances physically, cognitively, and spiritually (Coburn, Vartanian, and Chatterjee 2017). However, the importance of meaning, poetics<sup>1</sup>, atmosphere, connection, and ineffable dimensions of design in architecture has not been researched in sufficient depth. Even though modest attention has been afforded to such subjective qualities in the design of the buildings and spaces, this does not imply that they are less important than more quantifiable aspects such as form, function, space, and order. Inadequate knowledge of the contemplative facets in design, and insufficient awareness of the important role of the built environment and architecture on the users, have impacted the development of places that are characterized as bland & blasé and stereotyped as



without any sense of place and character to connect with people or to meet a fuller spectrum of human needs. Thus, with the unprecedented accelerating speed of industrial growth and our over-reliance on technology, we are now facing a loss of character, meaning, and poetics in the design of our environments -- we are moving towards an architectural homogenization (Travis 2020). We arguably need to revisit historical and iconic built environments that are silent witnesses of past eras. The “crisscrossed layers and crusts of cultures and landscapes graced by mankind’s-built legacies are a source of never-ceasing joy to us all” (Travis 2020).

There are many different types of places and projects in our cities and environments. Some spaces are positively charged, where everything flows, and one feels instantly welcomed, comfortable, and safe. Other places can be experienced as unpleasant, hostile, or even repulsive. We question why these spaces are different? And are distinctions primarily due to the design of the place or the experience by the users? Or perhaps both? Some places leave a positive long-lasting impression -- making one feel centered and connected with eternal energy within. Such places can be religious or secular -- regardless, they are fundamentally material in composition, such as wood, concrete, or structure. Julio Bermudez explains in *Transcending Architecture: Contemporary Views on Sacred Space* that “at its highest, architecture has the ability to turn geometric proportions into shivers, light into grace, space into contemplation, and time into the divine presence. A transcending architecture disappears in the very act of delivering us into the awesome and timeless space of the holy” (Bermudez & Ott, 2015, 3). **Architecture can be a mediating instrument to connect us with the so-called spirit or invisible energy, something larger than ourselves by virtue of being in space (Barrie 2012). Architecture can celebrate an axis mundus - a union of heaven and earth.** There are numerous non-religious architectural examples with transformational qualities and a strong sense of place. Projects such as Frank Lloyd Wright’s Falling Water, Louis Khan’s Salk Institute, Peter Zumthor’s Thermal Vals, Steven Hall’s St. Ignatius, and Le Corbusier’s Ronchamp Chapel are but some of the examples. Through rich design principles invoked in these buildings, including quality of light and color, sensual materials, poetics of water, rhythmic balance, and pleasing proportions, along with lyrical forms, strong character, and atmospheric sensations, they evoke transcendental encounters and elicit contemplative feelings.

The present paper builds upon an impressive existing body of knowledge, found through literature review, concerning spiritual architecture and sacred experiences within built environments. A main objective of this paper is to argue that life-enhancing architecture with transcendental qualities occurs when key design principles/qualities are united and in flow with one another, as well as when a connection is created between self and space -- that is, bringing the user in harmony with his/her surroundings. The authors, in the present paper and the associated research, delineate initial explorations of the interface and connection between transcendental experience and architecture to identify key criteria of ‘charged’ spaces. Such criteria are necessary as we examine the spirituality of architecture -- as the research aspires, downstream, to reveal the importance of meaning, relationship, and resonance in Islamic architecture to foster transcendental space.

One of the challenges of this topic is its subjectivity. Our scientific mind grapples with the concept of the sanctity of space and place. Sacred and transcendental places, however, need not be religious (Barrie 2012). In his article, A.T. Mann describes sacrality, from the view of the psychologist Carl Jung, as a space with “ethereal quality that has roots in the life of the soul and spirit rather than in any formal religious association” (2016, 274). The present research acknowledges the distinction between spirituality and religiosity, underscoring that transcendental qualities in space can be grasped by all people. Not all spaces are equal nor are they all transcendental -- rather, those that have such elevating qualities need to be critically examined and better understood. The present exploration and future research focus on two main questions: firstly, what are some design factors and forces that allow one to have an exceptional and transcendental experience within space? And, secondly, in a subsequent phase of the study, how are the principles of unity manifest in Islamic architecture?

Various types of spaces and architectural typologies have been examined in pursuit of the transcendental, connection to self, sense of place, and, most importantly, unity. While such studies provide valuable insights and foundations on the concepts of sacredness and transcending architecture concerning the current research, very little is currently known about the remarkable richness of Islamic architecture and its connection to self (our soul), and to the spirit of place (soul of place<sup>ii</sup>). As one of the well-known sacred architectural styles, and a potentially significant source of data, with its staggeringly rich roots and background in demonstrating the concept of oneness and unity since the 7th century, Islamic architecture encompasses both secular and religious types of design (Richman-Abdou 2018). Through its depth and multilayered design dimensions, including disciplines such as mathematics, physics, cosmology, astronomy, and geometry as well as clever use of color, forms, proportions, light, and symmetry, Islamic architecture can provide an incredible interdisciplinary platform for researchers to discover valuable insights into enhancing the modern design of our built environment (Akkach 2005).

This study utilizes a qualitative research method, in two phases of theoretical and practical explorations. In his thesis, *People, Place, and Spirit: Pursuing the Sacred in the Design of Built Environments*, Robert Birch has explored the connection of Taoism and Buddhism with architecture and discussed the sacred spaces in Japan in terms of secular building (Birch 2014). In his exploration, he identified a comprehensive set of criteria through which to analyze his case

criteria, explained in the following sections, that play an important role in the transcendental and meaningful experience of various well-known and exemplary architectural projects around the world. Specific criteria that will be explored in-depth, both in the theoretical phase as well as the experiential phase (visiting case studies) through the lens of Sufism are light/shadow, color, materiality, water, balance, and proportion.

The authors outline the thinking that underpins a broader research agenda, including presenting criteria for assessing spirituality in space and place. For future phases of this research, since unity is the fundamental doctrine of Sufism, this spiritual practice permits the authors to identify principles of relevance to major high profile Islamic architectural case studies, where the source and inspiration of design are driven by the concept of oneness (Tawhid)<sup>iii</sup>. It is important to stress that this sense of unity and oneness in Islamic architecture is not simply a religious belief or concept, rather it is more of a wise and intellectual stance that correlates with the mystical dimensions of Islam. It is useful to note that the identified criteria will be used to observe, compare, and contrast key Islamic architecture case studies located in Iran and Turkey, and most notably through the lens of Sufism. The specifics and details of the case studies are under consideration but they will be high profile, prominent, and well-received places that are known for their transformative qualities in Islamic architecture. The longer-term aim is to explore how the elements are orchestrated and composed in comparison to one another to create harmony in design, and ultimately emanate a transcendental experience of place -- connecting the outer ethos with the inner world. While Islamic architecture is the expected and inevitable focus of the current body of research, the present paper introduces a more general discussion of qualities of architecture that are shared amongst wisdom traditions and sets a stage for the next phase of the research which specifically examines various case studies in the Islamic world.

Ultimately, the application of the criteria to these case studies, along with the subsequent analyses of the sites/architecture, will lead to a set of design propositions to provide architects and scholars with a new perspective for researching, understanding, and creating spaces that deliver a stronger sense of flow and unity and to better connect to people on a more personal and spiritual level. A fundamental aspiration is, through design, to more seamlessly unite the environment with the self - an achievement common in sacred spaces, places, buildings and landscapes.

## 1.0 TRANSCENDENTAL ARCHITECTURE

To understand and discover ways of delineating transcendental space in architecture one first needs to understand the qualities of such space. Paul Goldberger, in one of his lectures in New York, defined sacred space as “the use of material forms to evoke feelings that go beyond the material and which cannot be measured” (2010). This type of architecture creates an indirect but delicate dialogue at the individual level, elevating an ordinary state of mind to a more contemplative and transcendental state, a state that is something vaster than ourselves, something that is whole and can give us a sense of unity with our surroundings. Mircea Eliade in his influential book *The Sacred and the Profane* discussed the sacredness of nature and the associated transcendence to the “high, infinite, eternal, powerful” (1959, 119). It is important to note that this transcendental state is not happening in the “outside world” but rather “outside of thought” signifying “that which is absolutely transcendent of all knowledge is the basis of your own being...it is immanent within you” (Campbell 2003, 6).

### 1.1. Spirit of Place

Buildings and places, especially when extraordinary, are a result of human imagination, skill, and knowledge. The higher mission of architecture is accomplished when the design and the experience of the space are merged to go beyond the ordinary. Transformative places can be felt with the heart and spaces can be experienced without sight. Transcendental architecture is a strong instrument that can ultimately act as a bridge through which we travel to the “inner spiritual realm” and connect with our “inner subjective space” (Harries 2015). In other words, not only does the architecture and quality of space prove important but also the discourse between the self and the place, as well as “what each individual brings to space” (Goldberger 2010). Consequently, for a place to have a long-lasting effect on its users, it is required to have a “vital force”, intrinsic value, and meaning (Goldberger 2010). The well-known architectural theorist, Christian Norberg-Schulz argues that all places have “genius loci”- spirit of place (1980). Norberg-Schulz implements a phenomenological Heideggerian approach, indicating that: “the spaces where life occurs are places... Architecture means to visualize the genius loci and the task of the architect is to create meaningful places, whereby he helps man to dwell” (1980, 5).

In our quest for identity in place, sacredness links humanity with earth, sky, and the celestial. Norberg-Schulz claims that to experience the qualities of space, architecture connects and creates a relationship between man and his built environment, bringing back and re-establishing the missing existential dimension (1980). To uplift the human spirit through uniting and enriching the relationship of the individual with the divine or something larger is one of the primary goals of architecture (Benedikt 2015). In other words, transcendental spaces perform related roles of connecting us with what otherwise would be inaccessible (Mann 2016). This implies that transcendental architecture acts as an “in-between” place connecting a user with a richer understanding of one’s self and others (Barrie 2012). That is to say, the message that all sacred places are sharing is the need to connect with the world within to experience the transcendent (Goldberger 2010). Such catharsis requires a conversation between the space and the self -- a “dialogue” that can



become a pathway in the experience of transcendence, serving to turn us inward to better connect with our soul (Walton 2015). Walton defines transcendence as an experience that “is not beyond us but within us” (Walton 2015).

The notion of transcendental experience and the connection with the world within also echoes the teachings of Sufism. The great Sufi master, Professor Nader Angha states: “the eternal dimension lies hidden within human beings and is inaccessible to their limited perceptions, thoughts, and sense. In this dimension, limitations and boundaries cease to exist and differences in race, ethnicity, culture, and gender are insignificant. Instead, the true value of each individual, which is the common essence among all human beings, governs” (2002, 125). Islamic architecture not only carries and reflects the culture and hymn of the past but also is inspired by the important and fundamental notion of balance and unity, most notably between the nonphysical world (Din) and the physical world (Duniya) (Bin Zayyad and Sinclair 2017). Sacred spaces in Islamic architecture, such as Khanegah<sup>iv</sup>, are often intended to act as a facilitator buttressing the journey of uniting us with our genuine internal state (Figure 1). Architecture and environmental design are powerful modes that can facilitate and ignite this spark -- even though, as noted, such feelings are universal and not limited solely to “sacred”<sup>v</sup> places. For example, in the practice of yoga or Zikr<sup>vi</sup>, even by non-spiritual practitioners, when the student is fully present in the moment and harmonizes his/her breathing with the movements, in one instant all distractions disappear and everything begins to “flow” (see Csikszentmihalyi, 1996); the person, the pose, the movement, and the environment all become one and united.



Figure 1: MTO Shahmaghsoudi Khanegah, Huston Source: (MTO 2015)

Hence, the authors hypothesis is that to create a transcendental or ineffable experience two components are required: Architecture (the external physical world) and the Self (the internal metaphysical world), where the experience of architecture and presence of self are merged through a bonding agent - flow and unity in design (Figure 2). Here the architecture and the self are inseparable and unified, which ultimately results in the coalescence of spirit of place with the spirit of self (soul). Self without the spirit is only the physical body -- flesh, bones, and cells -- and architecture without the spirit is just materials -- structure, concrete, steel, or wood.

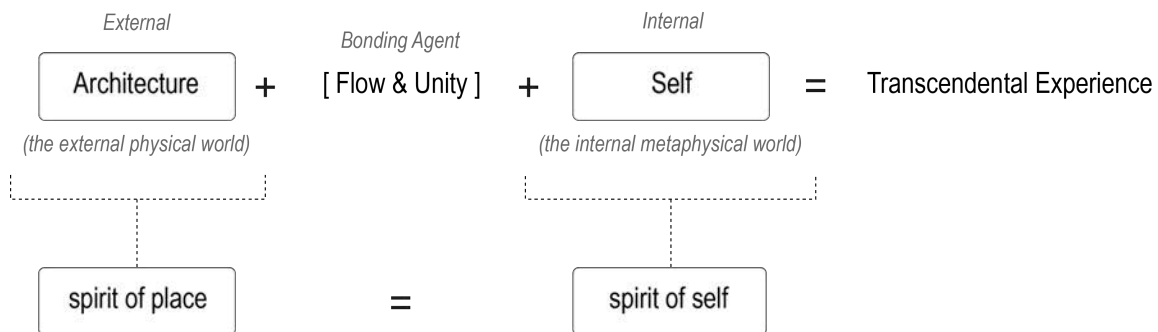


Figure 2: Transcendental experience and the relationship of architecture with self. Source: (Authors)

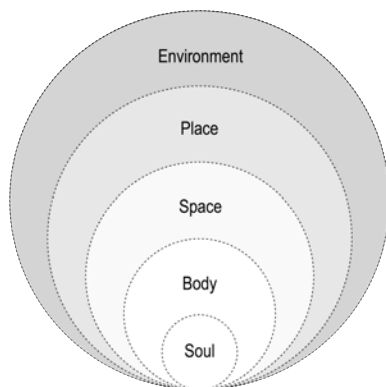
**To identify the bonding agent in the above equation, that is ‘flow + unity’, and to consider its various facets, this research proposes consideration of several principles of architecture developed by the authors, culled from various secular precedents, and drawn from western viewpoints on exemplarity in design.**

## 1.2. Resonance and relationship with space

Our physical body is the only instrument we have for experiencing and connecting with the world outside. However, we are not limited to connect with and understand our built environment through psychological and emotional interactions alone. The human body (the skin for example) and its multi-sensory systems are important in shaping our experience and understanding of architecture and space (Pallasmaa 2012). The human sensory system (e.g., sight, touch, smell, and sound) become effective receptors complemented by the body writ large -- enabling the individual to experience

space more richly and meaningfully. Pallasmaa defines the role of the body as the “locus of perception, thought, and consciousness” (2012, 10). That is to say, the transcendental experience manifests itself in the first instance through the senses, where the human body becomes a mediator between oneself, others, and the environment (Barrie 2012; Walton 2015). Pallasmaa aligns with Goldberger and Walton in describing sacred spaces as vehicles that create experiences, where physical qualities are transformed into “metaphysically charged feelings of transcendental reality and spiritual meanings” (2015, 19).

Architecture is not separate from its context and surroundings in a similar way that we, as users, are not separate from our place within the environment. Hyejung Chang argued that engagement of the “self in place” and unity with its surroundings create a spirit of the place (2015). Chang elaborates that spirit of the place is “associated with an aesthetic experience of place” and it eventually “transcends the moral accountability of the individual to include his or her community and broader environment” (2015, 135). It is only with full engagement of the self in a place that the spirit of place manifests. This relationship allows the self to step outside its more concrete or tangible realm to become united with its environments and expansive in wholeness (Figure 3). The result creates a “sense of balance and unity in place” -- such resonance implies total harmony once everything is aligned and integrated (Chang 2015, 140). Michael Benedikt explains resonance in architecture as a display of celestial “harmony and scale”(2015). Likewise, Mann describes the resonance of sacred places as “a transition point between heaven and earth, above and below, unconscious and conscious” (Mann 2016, 277).



**Figure 3:** Relationship of Soul to Environment - the outer world to the inner world. Source: (Authors)

In recent years, the marriage between neuroscience and architecture has led to various research pursuits which illustrate the impacts of human perception and cognition on the experience of space. Recent neurological research revealed that mirror neurons in the human brain provide humans with the remarkable ability to unconsciously replicate and imitate objects and materials by way of imagination and cognition (Pallasmaa, Mallgrave, and Arbib 2013). For example in dancing, similar brain activity is noticed whether we are observing another person dancing or we are dancing ourselves - the idea of empathy<sup>viii</sup> (Jelić 2015). These special neurons allow the human brain to animate the inanimate physical environment and surrounding that is being perceived by bringing the exterior world within through the senses and our perception to analyze and translate them into a feeling or an experience. This might explain why people tend to feel tense when viewing a twisted-column or alert when experiencing a sharp-edged design. Or account for our becoming uncomfortable when entering a dark and narrow hallway compared to seeing a light-colored feather-like transparent or floating screen. Or even our sense of heaviness and coldness when encountering concrete as a material or experiencing darker colors deployed in buildings. Research is revealing that the mind processes different qualities of space and place in distinct ways, resulting in attraction or repulsion, embrace or apprehensive, comfort or uneasiness, and so on. It is important to gain a deeper understanding of perception and cognition, in many ways revealed through the efforts in environmental psychology, in order to design more appropriate, meaningful, and impactful architecture (both spiritual and secular).

## 2.0 PRINCIPLES OF DESIGN

In considering the aspects of architecture that are elevating us, perceptually, cognitively, bodily, and spiritually, the authors pursued the delineation of key tools at the architect’s avail -- driven by a logic that if the parts are better understood, they might be deployed together in a project to realize a Gestalt. The following section of the paper identifies and explores core aspects of design, and in doing so aims to provide the substrate for transcendent architecture and their correlations to the physical and spiritual realm - most notably, in the longer-term agenda of the present research, through the lens of Sufism.

## 2.1. Light, shade, and shadow

Contributing to the deepest experiential qualities in architecture, light is one of the main elements in the sacred and transcendental experience of space (Pallasmaa 2015). Light is a main factor establishing the atmosphere and depth of the environment in space. Through light, the experience of lines, forms, colors, materials, and even textures are all enriched. "Illumination directs our movements and attention creating hierarchies and points of foci" (Pallasmaa, 2015, 24). Light has the powerful ability to enhance a temporal element to the shapes, and forms. Based on the angle and location of the buildings, these shapes and forms change during the day animating space. A Swiss architect Mario Botta believes in the connection of light with the sacred experience, defining light as "the visual sign of the relationship that exists between the architectural work and the cosmic values of the surroundings"(Cappellato 2005). Darkness and the absence of light also are necessary to achieve the full experience of light. It is through the effect of light and shadow that spaces are shaped and connected in creating a dynamic within a built environment and in nature (Tanizaki 1977).

One of the great examples of the use of light is noticeable in The Notre-Dame du Haut Chapel by Le Corbusier (Figure 4). The use of light in this building "introduces the visitor to a sense of inner harmony resulting from a state of spiritual transformation" (Lau, 2008, 2). By creating a series of windows with colored glass and thin gaps between the walls, the soft controlled light entering the building interacts with the interior forms, objects, and materials. As result, space is animated, and different atmospheres are formed throughout the day (Lau 2008). Pallasmaa in his article *Light, Silence, and Spirituality in Architecture and Art* explains the importance of light from the perspective of Louis Kahn. Pallasmaa writes "For Kahn light is the giver of all presence". He then states Kahn's famous quote on light: "all material in nature, the mountains and the streams and the air and we, are made of Light which has been spent, and this crumpled mass called material casts a shadow, and the shadow belongs to Light. So Light is really the source of all being" (Pallasmaa 2015, 23) (Figure 5). Light 'within' each individual can prove vital, as Arthur Zajonc writes: "Without an inner light, without a formative visual imagination, we are blind" (Zajonc & Perkowski, 1995, 5).

Traditionally pure light is related to symbols of sanctity and representation of the celestial in sacred architecture, within many religions and across many cultures. In Islamic architecture and Sufism, light represents the source of existence -- the eternal divine -- and it symbolizes the guidance source within the seeker's heart. Therefore, it is one of the more important design elements in Islamic art and architecture. It is through light that forms, shapes, textures and ultimately architecture is created, defined, and elevated. It can be claimed that If the human body represents the material dimension, then the inner spirit is the light and the source of life. Similarly, architecture exists because of light - light is spirit that gives it life to form and space.

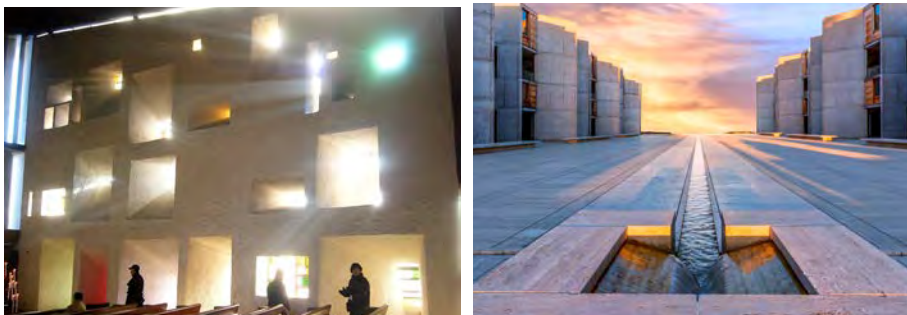


Figure 4 & 5: Notre-Dame du Haut Chapel by Le Corbusier and Salk Institute by Louis Kahn. Source: left (Kroll 2010) right (Schmalle 2016).

## 2.2. Color

The primary source of humans' understanding of colors comes from nature and the natural environment. However, of course, light and color are directly connected, and it is through the refraction of light that colors are created. In other words, white light encompasses the full spectrum of colors - all colors unified. Colors have powers and different meanings to different cultures, genders, and personal experiences and they can evoke immediate reactions in people. In architecture, colors accentuate forms and shapes and define spaces. Scientifically light is wavelengths and a different wavelength is a particular color. Colors have an impact on humans' feelings, productivity, concentration, and health. Researchers have demonstrated that "colors can create physical and unstable responses such as raising/lowering blood pressure, heartbeat, sweating, respiratory system, and even brain waves patterns" (Babakhani 2017, 5). "Colors feeds us emotionally; it is not just aesthetic. Every color creates a mood. We all need all colors at different stages of our life" (Linton 1999, 4).

Color can be used as a tool in transforming spaces -- color has the power to create more dynamic environments through the play with light. For example, Steven Holl's St. Ignatius Chapel with white interior walls uses the play of light and color through the concept of bottles where the light is "captured and stored, with each volume differentiated in form and reflected colors" (McLachlan, 2011, 58). The interplay of color and light reflecting off the curved surfaces creates a space with an elevated sense of place for the users.

The use of color is also a fundamental part of James Turrell's projects, an architect known for his contemplative and meditative projects. His work simply changes the viewer's perception, captures their attention, and allows them to enter a different realm to perceive their surroundings in a new manner and have a mystic allusion experience. Terrell's use of color is different than just applying a color to a surface -- rather he applies color through light. In his projects, Terrell creates a parallel "experience of 'Ganzfeld': a German word to describe the phenomenon of the total loss of depth perception as in the experience of a white-out" (Turrell 2013). In his projects one is immersed into "colored air invoking delicate sensations of skin contact, temperature, and oscillation; these spaces make one feel as if one is being submerged in a transparent, colored substance that turns light and color into haptic sensations" (Pallasmaa 2015, p. 26).

Color and light are, of course, inseparable. Color is born of pure light which is colorless in essence and symbolizes unity and oneness. In Islamic architecture, color is the representation of diversity in unity. Once the seeker's heart is detached and cleansed from the colors of the external world (materiality), what is left is pure light that shines within and manifests the divine. "The Essence of the First Absolute Light, God gives constant illumination, whereby it is manifested, and it brings all things into existence, giving light to them by its rays. Everything in the World is derived from the Light of His Essence and all beauty and perfection are the gift of His bounty, and to attain fully to this illumination is salvation" (Suhrawardi 1950).

### 2.3. Materiality

Architecture becomes visible through the art of arranging materials into forms, shaping spaces, and permitting interactions of light and surface in specific ways to meet intentions. By using different materials in a project, and understanding how they connect, play, and interact with one another, different feelings and emotions can be experienced. It is through the realization of 'atmospheres', which is created through a combination of material, light, forms, and sounds, that one connects to space and set into harmony with the place. Peter Zumthor has been exploring the importance of atmosphere in his projects for many years. In his book entitled *Atmospheres*, he explains the relationship between a building, its environment, and the sensory aspects of architecture. Zumthor describes atmosphere as "this singular density and mood, this feeling of presence, well-being, harmony, beauty ... under whose spell I experience what I otherwise would not experience in precisely this way" (2006). His project Thermal Vals in Switzerland is an exploration of attaining atmosphere using materiality, water, and nature (Figure 6). As a modern secular building, this project capitalizes on phenomenology and considers how one feels in the spaces. The richness of the stone walls interplaying with water, light, and spatial order establishes rich links with our senses whereby we are more engaged with the environment -- in essence meaningfully connected to our inner being (Birch 2014). This relationship is achieved by responding to the topography of the site while deploying stone and water in ways that signify unity and harmony with nature -- choreographing experience and facilitating meaning as one travels through and encounters the spaces.

In Sufism, the source of life or the divine is within the physical body in the center of the heart (Angha, 2002). Through the journey of self-cognition, once all the attachments to the material world and the physical body are removed, the seeker is then united with the source within. In Islamic architecture, the physical form symbolizes and materializes this eternal invisible source and the architectural forms along with the spaces are the means to represent and access this invisible.

### 2.4. Water

Water, one of the four main elements (earth, water, fire, air) of nature, is an important substance of life and offers vitality and fluidity. Whether in rest or motion, and whether placed indoors for aesthetics or outdoor in courtyards or gardens (even in-between places), we cannot help but be profoundly influenced by its poetic rhythms, sounds, overall presence, and flow. As Robert Birch states in his thesis "...water is the essence of life and the connection to water through place signifies a connection to an elemental place in Ourselves" (Birch, 2014, 87).

Similar to the Thermal Vals project, Tadao Ando in his project Water Temple achieves different forms of atmospheres with the use of concrete and water (Figure 8). In this project, the large, calm, and peaceful oval pool of water reflects the scene behind the temple, in silence, where the surrounding natural environment is elegantly brought into the design to create a pleasant and harmonious union of architecture and nature. In Frank Lloyd Wright's Falling Water, water "is the protagonist" of the design (Simona and Norafida 2020). The house is built within the landscape (of the hill rather than set merely upon it) where nature is part of the building and the building is part of nature (Figure 7). Here the building blends into the landscape rich with trees, rocks, waterfall, and streams -- the project is placed so carefully into the context as if it had been there since the beginning of time (Simona and Norafida 2020). The peaceful feeling of being in a purely natural environment and hearing the sound of rushing water is mesmerizing and serene.

Traditionally water has played a role across wisdom traditions representing life and growth as well as purity and cleansing. Examples through history include the presence of water in Hindu temples, the use of water in baptism in Christianity, and the use of water as a symbol of purification and cleansing before prayers in various religions. In Islamic

architecture, a reflective pool or water fountain is commonly placed in the courtyard for ablution (cleansing) and to symbolize the vital connection between earth and heaven. Specifically, as we look to heighten the efficacy of design guidelines to promote sacred architecture, we see the role of water as fundamental for amplification of tenet principles and core doctrine of Islam.



**Figure 6, 7 & 8:** Thermal Baths in Vals by Peter Zumthor, Falling Waters by Frank Lloyd Wright, & Water Temple by Tadao Ando. Source: left (Fouillet 2018) center (Allen 2016) right (Cappadoro 2015)

### 2.5. Balance and Proportion

Balance is a fundamental aspect of design's capacity to reach tranquility and achieve a transcendental state. Balance is not necessary for the presence of symmetry. However, it is "life-filled and breathes from one side to the other" (Day, 2004, 204). It is a matter of having the right proportion, scale, light, material, and other aspects of the design in balance to create an effective environment. The traditional architectural proportions can be noticed in "the human body, in nature, mathematics and the physical wavelengths of music" and they are in a sense "natural" (Day, 2004, 108). Proportion is the relationship of the parts to the whole and it is directly related to the aesthetic of the space. Without balance and proportions, chaos arises and harmony is lost which results in loss of aesthetics as well.

Whether the places are designed to be at rest or have a directional dynamic and feeling all are governed by proportion. Various proportions have distinct qualities to them and by changing the proportions of designs these qualities change accordingly. For example, we may feel insignificant when standing inside the Notre Dame Cathedral with such high ceilings and walls -- experiencing a transcendental feeling with complete silence within and full presence at that moment. Even though having heights and scale is important in the transcendental experience of a place, it may alone prove insufficient -- vertical proportions and person-space aspects are also required. Duncan Stroik in his article *Transcendence, Where Hast Thou Gone?* explains the importance of height and size in the experience of transcendence. However, He argues that "it is not sufficient to have a tall building to gain an experience of transcendence" (2015, 242). To make his point, Stroik compares the Houston Astrodome at 200 feet tall with St. Peter's Basilica in Rome at only 150 feet tall. He argues that these two places are different places with different characteristics and that height and size alone are an inadequate indicator of awe. Even though the Astrodome is bigger, and by many comparisons simply huge, it is not transcendent as a piece of architecture. Stroik explains that "The vertical proportions, the way light enters, fine materials, and the particular architectural syntax all combine to express transcendence. There is not one single reason but many that come together to create a sense of transcendence" (2015, 242).

The physical and nonphysical aspects of architecture are, in many instances, inseparable. However, it is only through harmony and balance where the connections can be deeply and genuinely experienced. In Islamic architecture balance and proportion mainly comes from natural harmonious sources of the human body, nature, cosmos. Balance is created through the unity and interactions of all the design elements both symmetrical and asymmetrical. Once the right balance and proportion of the physical space are aligned with the spiritual and nonphysical attributes, a transcendental experience is shaped and can be experienced. In Sufism balance and equilibrium is the main characteristic of the central source (pure light) within each individual. The law of balance and harmony is inherent and visible in every corner of nature and the whole universe. Sufism mainly focuses on the connection of each individual, "as part of the universe and therefore bound to the same laws of physics" (MTO 2015), and emphasizes the cognition of this perfection only within the inner source where both physical (material) and spiritual (eternal) worlds are in harmony and balance.

### 3.0 SYNOPSIS

It is not simply the fact of having one element or the other in the design of a place that is most critical, but rather the degree and connection of elements to one another and their priorities in the overall spatial composition. The ingredients of a project, in and of themselves, do not equate with exceptionality. However, with careful intentions and skills, the combination of different design principles and elements can create a transcendental experience within architecture where one connects with space and self at the same time. This is strongly visible in Islamic architecture all around the world. The concept of flow and unity has been the main guiding point for this style of architecture as a mediator -- connecting with the divine (the one) physically and externally, but also linking with the eternal and peaceful source internally and spiritually. The pressing question is: How we can achieve flow and unity between specific elements in



the design to create an extraordinary scene that can be extraordinarily experienced? Further, how can we create a space that is capable to “take us out of our quotidian existence and transport us to another state of being”? (Crosbie, 2015, 122). Quality in architecture can engage the user and inspire us to have a deeper sense of self in place. It will connect us with our environment in profound and transformative ways. Transcendental architecture creates exceptional moments that will “enliven our meaningful associations with all of its elements, features, and patterns, and inspire us to transcend our narrow notion of self-bound aesthetic delight and moral fulfillment so that we may encompass the whole world” (Chang, 2015, 149). The present paper opens some key doors within a broader research agenda. More specific and detailed study of the above-mentioned elements, their symbolism, and association with Sufism, comprise a second and vital stage of this research. Through exploring and critically analyzing various case studies (namely in Iran and Turkey) the researchers intend to unveil additional meanings and relationships between the physical and the spiritual aspects of design in Islamic architecture. While the lessons learned through such study prove valuable to the design of projects within Islam, there are many aspects that will prove applicable to sacred space in other wisdom traditions as well as, increasingly, within secular spaces and places. Meaning and transcendence in architecture prove relevant across a much broader spectrum of environments, encounters and experiences.

## CONCLUSION

“Architecture does not exist, what exists is the spirit of architecture.” Louis Kahn

The need for, and importance of, creating timeless and transcendental spaces is more visible now than ever in our world. Today, where almost everyone is becoming increasingly detached from their inner self and the natural environment, architecture can be a positive force. People are constantly preoccupied with consumerism, technology, virtuality, and other external agents -- resulting in exhaustive negative effects including unacceptable stress. Given these challenges architects and environmental designers must engage cautiously yet assertively, delivering spaces with a contemplative atmosphere that convey deeper meanings, not only to bring back the spirit of the space but to also find a balance between physical and nonphysical qualities of the architecture. We all need to reconnect with nature and, more vitally, with the ‘true essence’ of our being -- the stable, secure, and peaceful center within. Architecture is a potent medium through which we might encounter places that lead us to an ethos where reuniting and reconnecting with our soul, others, and the environment is possible. Such architecture consists of various design elements, features, and facets --such as the ones explained in this paper -- that have different catalytic qualities and various degrees of impact. When these design components are properly arranged and correctly orchestrated in balance and harmony, they can alter the quality of the space and create atmospheres that can elevate one's feelings and leave a long-lasting influence. While light, color, materiality, water, balance, and proportion can be seen in a generic sense impacting architecture in general, our interest resides specifically in sacred architecture and the role these principles and qualities can play in providing a transcendental experience of space. Sacred architecture, through its constituent components and meaningful composition, can heighten our sense of place, our sense of identity, and our sense of belonging.

In the next phase of this research, and to better understand the effects and arrangements of the previously explained design elements as well as their impacts on the quality of space, the authors will physically travel to and investigate numerous high profile Islamic architectural case studies where flow, balance, and oneness reside at the core of the projects. In this work, the research will explore architectural, philosophical, and cosmological theories on spirituality, self, and transcendental spaces, and notably through the profound lens of Sufism and its longstanding concept of unity. This paper, while exploring a range of qualities that are common to architecture, more specifically aims to emphasize and focus on the value and the impact of “flow and unity” on Islamic spaces and its ability to create a transcendental experience for all.

The current paper and future corresponding research strive to contribute new knowledge to the current literature in the following ways;

1. Exploring and expanding the concept of unity in Islamic architecture through the lens of Sufism
2. Providing new design guidelines for creating meaningful and transcendental spaces
3. Defining and exploring qualities of spaces (secular and sacred) that contribute to the concept of ineffability and transcendence of the place.
4. To deliver better understanding importance of environmental design (external world) and its direct connection with the self (the internal world) through the concept of flow and unity borrowed from one of the well-known and rich architectural styles (Islamic architecture).

It is hoped that the findings from the case study explorations will provide a new design criterion along with a new understanding and importance of specific design elements in creating meaningful spaces in architecture and the design of our built environments.

There are still many questions to be answered and many more areas to be explored. What are the fundamental architectural attributes that create transcendental spaces? Is there a specific number or order of design elements that are required in the creation of transcendental space? Is there a framework that could introduce the initial design



parameters and guide architects aspiring to elevate their design potency and spatial choreography from every day to transcendental? Such topics are expansive yet compelling and urgent. The present research raises questions to shed light on the topic of transcendental spaces in architecture. Through investigating some of the dimensions and features, in both secular and Islamic architecture, this research aims to better understand the attainment of transcendence in design. Further, through demonstrating concepts rooted in Sufism, the next phase of the research intends to open doors to proven design methods in connecting place and self. Sufism with its reach into both physical and metaphysical realms offers an exceptional and valuable lens through which we can better understand the existence of the self and its connections to the outer world.

As this study defines a relationship between sacrality and self, the authors contend that such awareness can prove valuable to design practitioners and related researchers in the field of environmental design in the quest to create transcendental places, with many illuminations finding applicability in non-religious architecture, as well as religious and spiritual traditions extending beyond the boundaries of Islam.

## REFERENCES

- Akkach, Samer. 2005. *Cosmology and Architecture in Premodern Islam*. New York: New York: State University of New York Press.
- Allen, Eric. 2016. "5 Examples of Iconic Modern Architecture That Have Serious Flaws | Architectural Digest." Retrieved from Architectural Digest: Dec 12, 2020. <https://www.architecturaldigest.com/story/modern-architecture-that-have-serious-flaws>.
- Angha, Nader. 2002. *Theory "I": The Unlimited Vision of Leadership*. Riverside, CA: Riverside, CA: M.T.O. Shahmaghsoudi Publications.
- Babakhani, Reza. 2017. "Color and Light in Architecture and Its Effects on Spirits of Space Users in a Psychological View." *Journal of Architectural Engineering Technology* 06 (01): 1–6.
- Barrie, Thomas. 2012. "Sacred Space and the Mediating Roles of Architecture." *European Review* 20 (1): 79–94.
- Benedikt, Michael. 2015. "On Architecture, Divinity, and the Interhuman." In *Architecture, Culture, and Spirituality*, edited by Julio Bermudez, Thomas Barrie, and Phillip James Tabb, 15–25. New York: New York: Routledge.
- Bermudez, Julio, and Randall Ott. 2015. *Transcending Architecture: Contemporary Views on Sacred Space*. Edited by Julio Bermudez. *Transcending Architecture: Contemporary Views on Sacred Space*. Washington, D.C: Catholic University of America Press.
- Birch, Robert A. 2014. "People, Place, and Spirit: Pursuing the Sacred in the Design of Built Environments." The University of Calgary.
- Campbell, Joseph. 2003. *Myths of Light: Eastern Metaphors of the Eternal*. Novato, CA: New World Library.
- Cappadoro, Agnès. 2015. "Tadao Ando." Retrieved from Chronotes: Dec 23, 2020. <https://media.thisisgallery.com/20204012>.
- Cappellato, Gabriele. 2005. *Mario Botta: Light and Gravity: Architecture, 1993-2003*. Munich, Germany: Prestel.
- Chang, Hyejung. 2015. "An Aesthetic and Ethical Account of Genius Loci." In *Architecture, Culture, and Spirituality*, edited by Julio Bermudez, Thomas Barrie, and Phillip James Tabb, 133–51. Ashgate Publishing.
- Coburn, Alex, Oshin Vartanian, and Anjan Chatterjee. 2017. "Buildings, Beauty, and the Brain: A Neuroscience of Architectural Experience." *Journal of Cognitive Neuroscience*, 1–11.
- Crosbie, Michael J. 2015. "The Sacred Becomes Profane." In *Architecture, Culture, and Spirituality*, edited by Julio Bermudez, Thomas Barrie, and Phillip James Tabb, 114–32. Ashgate Publishing.
- Csikszentmihalyi, Mihaly. 1996. *Creativity: Flow and the Psychology of Discovery and Invention - ProQuest*. 6th ed. New York: Harper Collins Publishers.
- Day, Christopher. 2004. *Places of the Soul: Architecture and Environmental Design as Healing Art. Places of the Soul: Architecture and Environmental Design as Healing Art*. 2nd ed. Oxford, UK: Architectural Press.
- Eliade, Mircea. 1959. *The Sacred and The Profane*. Translated by Willard R. Trask. New York: Harcourt, Brace & World.
- Fouillet, Fabrice. 2018. "Peter Zumthor, Morphosis Architects / Thom Mayne, Fabrice Fouillet · Thermes Vals AT 7132 Hotel · Divisare." Retrieved from Divisare: Nov 18, 2020. <https://divisare.com/projects/388269-peter-zumthor-morphosis-architects-thom-mayne-fabrice-fouillet-thermes-vals-at-7132-hotel>.
- Goldberger, Paul. 2010. "Architecture, Sacred Space, and the Challenge of the Modern." Retrieved from Paul Goldberger: Oct 18, 2020. <http://www.paulgoldberger.com/lectures/architecture-sacred-space-and-the-challenge-of-the-modern/>.
- Harries, Karsten. 2015. "Transcending Aesthetics." In *Transcending Architecture: Contemporary Views on Sacred Space*, edited by Julio Bermudez, 208–22. Washington, D.C: Catholic University of America Press.
- Jelić, Andrea. 2015. "Designing 'Pre-Reflective' Architecture." *Ambiances Architectures Urbanités (AAU) (AAU)*, no. 1: 0–16.
- Kroll, Andrew. 2010. "AD Classics: Ronchamp, Le Corbusier." Retrieved from ArchDaily: Dec 8, 2020. <https://www.archdaily.com/84988/ad-classics-ronchamp-le-corbusier>.

- Lau, Benson. 2008. "The Poetics of Sacred Light - A Comparative Study of the Luminous Environment in the Ronchamp Chapel and the Church in the Monastery of La Tourette." *PLEA 2008 - Towards Zero Energy Building: 2 5th PLEA International Conference on Passive and Low Energy Architecture, Conference Proceedings*, no. July.
- Lehman, Maria Lorena. 2009. "What Makes Poetic Architecture?" Retrieved from MII Design Lab: Dec 12, 2020. <https://www.mlldesignlab.com/blog/what-makes-poetic-architecture>.
- Linton, Harold. 1999. "Color in Architecture - Design Methods for Buildings, Interiors, and Urban Spaces." *Color Research and Application*. New York: McGraw-Hill.
- Mann, A. T. 2016. "Sacred Landscapes: The Threshold Between Worlds." In *Architecture, Culture, and Spirituality*, edited by Julio Bermudez, Thomas Barrie, and Phillip James Tabb, 273–94. New York: New York: Routledge.
- McLachlan, Fiona. 2011. "Altered Space: The Transformative Capabilities of Colour and Light in the Architecture of Steven Holl and UN Studio," no. 1997: 58–61.
- Modell, Arnold H, Jeffrey Poland, and Jennifer Radden. 2003. *Imagination and the Meaningful Brain*. Cambridge, UNITED STATES: MIT Press. Retrieved from Ebook Central: Dec 10, 2020. <http://ebookcentral.proquest.com/lib/ucalgary-ebooks/detail.action?docID=3338500>.
- MTO, Shahmaghsoudi. 2015a. "Houston - MTO Centers." Retrieved from M.T.O. Shahmaghsoudi Publications: Nov 18, 2020. <http://suficenters.org/usa/houston-construction/>.
- . 2015b. "The Khaneghah - MTO Shahmaghsoudi ©." Retrieved from M.T.O. Shahmaghsoudi Publications: Nov 20, 2020. <http://mtoshahmaghsoudi.com/about-m-t-o/the-khaneghah/>.
- . 2015c. "Zikr: Remembrance." Retrieved from M.T.O. Shahmaghsoudi Publications: Jan 17, 2021. <http://www.mto.org/aos/Main/All/en/Zikr.html>.
- . 2015d. "Balance and Equilibrium in Sufism." Retrieved from M.T.O. Shahmaghsoudi Publications: Feb 18, 2021. <http://www.mto.org/aos/Main/All/en/balance.html>.
- Nasr, Seyyed Hossein. 1964. *An Introduction to Islamic Cosmological Doctrines*. Cambridge, Mass: Belknap Press.
- Norberg-Schulz, Christian. 1980. *Genius Loci, Towards a Phenomenology of Architecture*. New York: New York: Rizzoli International Publications Inc.
- Pallasmaa, Juhani. 2012. *The Eyes of the Skin: Architecture and the Senses*. Chichester: John Wiley & Sons Ltd.
- . 2015. "Light, Silence, and Spirituality in Architecture and Art." In *Transcending Architecture. Contemporary Views on Sacred Space*, edited by Julio Bermudez, 19–32. Washington, D.C: Catholic University of America Press.
- Pallasmaa, Juhani, Harry Francis Mallgrave, and Michael Arbib. 2013. *Architecture and Neuroscience*. Edited by Philip Tidwell. Espoo, Finland: The Tapio Wirkkala-Rut Bryk Foundation.
- Richman-Abdou, Kelly. 2018. "The Distinctive and Dazzling Elements of Islamic Architecture." Retrieved from: My Modern Met, Nov 27, 2020. <https://mymodernmet.com/islamic-architecture/>.
- Schmalle, Robert. 2016. "Sunrise At Salk." Retrieved from 500px: Dec 22, 2020. <https://500px.com/p/robertschmalle?view=photos>.
- Simona, Canepa, and Ab Ghafar Norafida. 2020. "Water in Architecture, Architecture of Water." *Journal of Civil Engineering and Architecture* 14 (5).
- Stroik, Duncan G. 2015. "Transcendence, Where Hast Thou Gone?" In *Transcending Architecture: Contemporary Views on Sacred Space*, edited by Julio Bermudez, 239–46. Washington, D.C: Catholic University of America Press.
- Suhrawardi, Shahab Aldin. 1950. "Hikmat Al-Ishraq." Translated by M. Smith, In *Readings from the Mystics of Islam*, 79. London.
- Tanzaki, Jun'ichirō. 1977. *In Praise of Shadows*. Leete's Island Books. New Haven, Conn: Leete's Island Books.
- Travis, Price. 2020. "Spirit of Place Spirit of Design." Retrieved from Spirit of Place - Design: Dec 12, 2020. <https://spiritofplace-design.com/about-2/philosophy/>.
- Turrell, James. 2013. "Double Vision." Retrieved from James Turrell: Dec 22, 2020. <https://jamesturrell.com/work/type/ganzfeld/>.
- Walton, Thomas. 2015. "Exploring Transcendence." In *Transcending Architecture. Contemporary Views on Sacred Space*, edited by Julio Bermudez, 260–66. Washington, D.C: Catholic University of America Press.
- Zajonc, Arthur, and Sidney Perkowitz. 1995. *Catching the Light: The Entwined History of Light and Mind. Physics Today*. Oxford: Oxford University Press.
- Zayyad, S Bin, and B Sinclair. 2017. "Culture, Context + Environmental Design: Reconsidering Vernacular in Modern Islamic Urbanism," no. November 2019: 223–29.
- Zumthor, Peter. 2006. *Atmospheres: Architectural Environments, Surrounding Objects*. Basel, Switzerland: Birkhäuser.

---

<sup>i</sup> "Poetics is that moment in architecture when elements yield more than the sum of their parts. It could be, perhaps, the way architecture is able to touch its occupants on deeper emotional or spiritual levels. It could also be the way architecture can convey beauty together with meaning that leaves one feeling more fulfilled (Lehman 2009).

<sup>ii</sup> The soul of place is an intangible feeling" generated through a "composite of sensory experiences reinforced by historical [and individual] associations"(Day 2004).

<sup>iii</sup> Islam, as a religion, is a way of unity and totality. Its fundamental dogma is called Et-Tawhid, that is to say unity or the action of uniting (Nasr 1964).

<sup>iv</sup> To gain any kind of knowledge, one needs to go to school and turn to the teacher who has the knowledge. In Sufism, the school is called Khaneghah where the Salek (or seeker) would turn to for spiritual guidance. "Khaneghah" or "Khaneh-gah", literally means the "House of Present." "Gah" is that real or true moment in which a person is present. It is that moment of presence that one needs to continuously reach and prolong, both inwardly and outwardly (MTO 2015b) Retrieved November 29, 2020 from: <http://mtoshahmaghsoudi.com/about-m-t-o/the-khaneghah>.

<sup>v</sup> The Sacred is an ethereal quality that has roots in the life of the soul and spirit rather than in any formal religious association (Mann, 2016, p.274).

<sup>vi</sup> In Sufism "Zikr means remembrance. By moving from left to right, the rhythm and motion of Zikr are dictated by the heart in the form of the infinity sign. One moves from left to right making the figure eight ( $\infty$ ) to represent the scientific symbol of infinity while singing the specific phrase or verse. At the center of this infinity sign is the heart where total concentration must reside to experience the reality within and connect to the true self"(MTO 2015c) Retrieved Jan 17,2021 from: <http://www.mto.org/aos/Main/All/en/Zikr.html>.

<sup>vii</sup> Unconscious process in which the individual uses his own body as a template that enables him to feel into the other's experience (Modell et al., 2003, p.121)

# Qal'at Sim'an, A New Venue of Power in Late Antique Syria

Laura Hollengreen<sup>1</sup>

<sup>1</sup>University of Arizona, Tucson, AZ

**ABSTRACT:** One way in which architecture “performs” is by providing a site for socio-cultural mediation among peoples with diverse needs. A pertinent premodern example, from a disintegrating empire, is the fifth-century Monastery of Qal'at Sim'an in Syria. At this site, Simeon the Elder, a stylite saint, practiced his asceticism atop a tall column for almost 40 years. Afterwards, a martyrium was built around his column in order to commemorate him; an adjacent monastery housed pilgrims who visited the church, as well as those who ministered to them. This paper will explore the initial, private ascetic performance of Simeon's body; then the column as architectural prop for his practice, creating an elevated site visible to others; and finally the monumental architecture intended to graft Simeon's individual fame into the power exercised by the Eastern Orthodox Church as an institution.

Simeon's church provided a permanent focal point for the circulation of local peoples and distant travelers. It forged a perfect memorial to the holy dead and is regarded as one of the most significant works of late Roman architecture. Indeed, its elegant composition foreshadowed the integration of formal types at Hagia Sophia and the construction was so fine that scholars have assumed imperial patronage. Together, the site, the column, and the building design crystallized socio-political and religious change. They performed culturally for Simeon and later church officials by making visible the dynamic opportunities when long-standing institutions and social hierarchies break down and new people emerge to formulate new methods for achieving peace and prosperity. Dispensing exhortations and miracles, Simeon wielded considerable authority from atop his column and, later, after death, from his church, eclipsing that of local pagan gods and magistrates alike.

**KEYWORDS:** Asceticism, medieval saint, Roman architecture, Byzantine architecture

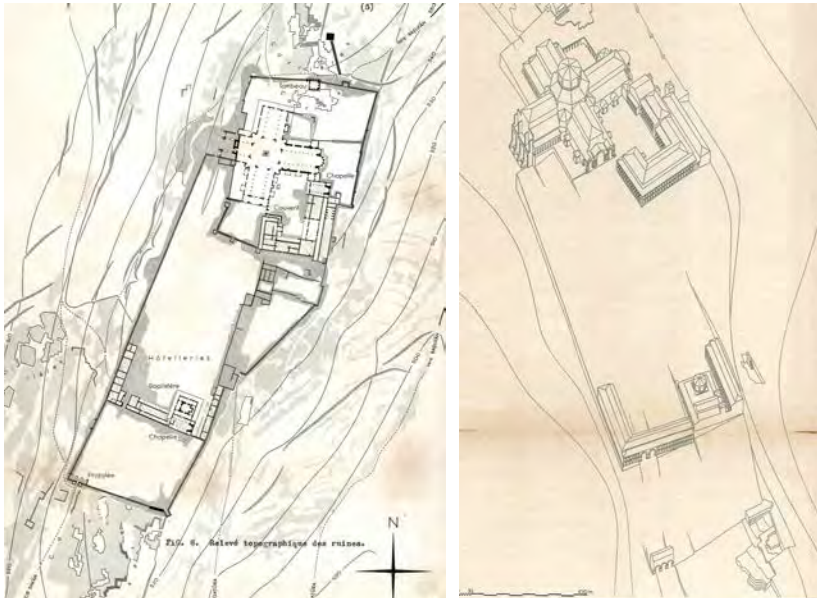
## INTRODUCTION

In investigating architectural performance in the cultural realm, we do well to remember architectural historian Spiro Kostof's basic definition of architecture at the beginning of his paradigm-changing textbook, first published in 1985: “the material theater of human activity” (Kostof 1995, 3). Kostof's choice of the word “theater” rather than, say, “setting” or “site” or “container” indicates his essential engagement with architectural communication and the construction of meaning. This communication happens because architecture is both *embodied* in material form and *embedded* in a matrix of socio-cultural conditions. The fifth-century ecclesiastical site of Qal'at Sim'an provides an intriguing case study for the embodiment of ascetic practice and its architectural tools and also for the embedding of such practice and its props within larger, supra-individual institutional concerns. Well-known by Byzantinists but less familiar to a broader audience, the socio-spatial matrix at Qal'at Sim'an also provides an opportunity to examine historians' performance in relation to changing historiographical paradigms of the classical and the medieval, and the center and the periphery.

St. Simeon Stylites the Elder (ca. 386-459 CE) was a man who rejected communal monasticism as too corporate and confining. He ultimately chose to live for more than four decades perched atop a monumental Roman column in the open air on a rocky promontory above the village of Telneshe, about thirty miles from Aleppo. It is this column, *stylos* in the original Greek, that gave him and other pillar saints their epithet: *Stylites*. For a hermit like Simeon, seeking to dedicate himself wholly to performance of praise, prayer, and penitence, even the rarified practice of living above the ground plane was not enough to avoid the distractions of those earth-bound faithful who sought him out for intercession and judgment; as a result, Simeon moved to successively taller columns, ending up atop a final column up to 60' tall. (The most recent archaeological evidence is presented in Schachner 2010.) He died on it at the approximate age of 72.

Throughout his life, Simeon's column remained in the open air and he at the mercy of the elements. So successful was Simeon in settling disputes and matters of conscience in the Syrian villages around him that more and more pilgrims came to visit his column and, after his death, a memorial church was built in his honor around the final column (Fig. 1). A monastic community grew at the base of the column in order to minister to visiting pilgrims from near and far. The complex of Qal'at Sim'an eventually included quarters for monks who lived there, temporary housing for pilgrims, two baptisteries for those inspired by Simeon to undertake ritual death and rebirth in baptism, a triumphal arch, and more.

The architectural and ecclesiastical climax of the complex was a huge martyrium (at the north end of the site) which combined centralized and longitudinal forms and was meant to foster memory and house worship.



**Figure 1:** Qal'at Sim'an ca. 500, plan and axonometric. Source: Leeming and Tchalenko 2019

This paper investigates the initial localization of new power in the suffering, disciplined body of the saint; then his adoption of an architectural prop in situ that both distanced his body from others and made it more visible; and, finally, in the absence of the body (which was appropriated for another site after Simeon's death), construction of a church which served as monumental celebration of the saint's prop-become-relic. How did the body perform in a way that attracted respect and veneration? How did architecture serve to heighten this performance materially, visually, and symbolically? How and why did the architectural setting for asceticism expand to serve other programs and purposes? Sources that shed light on these issues include three versions of the life of St. Simeon (Doran 1992), two in Greek, one of them written before his death, and a third, the longest, in Syriac; other ecclesiastical texts; the "lapidary" evidence of standing buildings and the archaeological record at Qal'at Sim'an; and related medieval imagery in sculpture, painting, and small pilgrimage objects.

If Kostof's lapidary statement is one bookend to this study, the work of historian Peter Brown is the other. Fifty years ago, near the beginning of his career, Peter Brown published "The Rise and Function of the Holy Man in Late Antiquity," a now-classic article that brought the period of the late Roman Empire under fresh scrutiny (Brown 1971). Gone were the laments about late imperial decadence, the tired assumptions about the political and social hierarchy of imperial capital city over rustic periphery, and the automatic privileging of elite culture over popular practice. Gone, too, were the dichotomies between pagan antiquity and Christian Middle Ages, and the voice of the learned theologian and exegete at the expense of the preacher, pastor, and miracle worker (Brown 1998a). In Brown's account, Early Christian saints were reborn: no longer were they seen simply as pious witnesses to a spreading and soon dominant new faith but rather as active political agents who by virtue of remarkable ascetic practice gained the distance from contemporary society to be regarded as arbiters in a period of social, political, and economic change. In short, Brown used the image of the holy man, "like a mirror, to catch from a surprising angle, [a] glimpse of the average Late Roman" (Brown 1971, 80). Although architecture was never Brown's focus, his work points the way to a history that does not automatically privilege institutions—or at least complicates and contextualizes them—and that identifies the impetus for major historical change in the granular activity of individuals in dispersed locations far from centers of power.

## 1.0 BODILY PERFORMANCE: THE EXAMPLE OF ASCETIC DISCIPLINE

The *Lives* of St. Simeon the Elder testify to the rigors and regularity of his ascetic practice of the body: his standing in place for days, weeks, months, and years; his repeated prostrations and prayers; his refusal of food; and his highly controlled interactions with others. Syrian asceticism was regarded as a kind of martyrdom and mourning through mortification of the body (Brock 1973). The body was not deemed intrinsically evil, however, as in dualistic theology elsewhere in the Early Christian church; instead, it was the very site of knowing (Harvey 1999), an epistemological tool which, partnered with the soul, operated in a "single field of force" for an encounter with that which defied human comprehension (Brown 1998b). In the Syrian case, which initially favored the individual asceticism of the hermit over the communal or cenobitic asceticism of the monastery, physical feats of extreme self-mortification on the part of the

“athlete of virtue” worked a dissociation that made the hermit seem a stranger and even something other than human, an angel operating on a different plane from other mortals (Harvey 1998). Brown describes the holy man as the consummate spiritual professional when it came to ceaseless prayer, contrition, and religious self-definition:

It is perhaps one of the most faithful indications of the whole style of Late Roman society that the objectivity that men so desperately needed was less often vested in impersonal institutions, such as the oracle site, or in depersonalized figures, such as the possessed medium, but was only thought acceptable in a man who could be closely observed to be in the act of forging total dissociation in himself, by hammering it out like cold metalwork, from a lifetime of asceticism (Brown 1971, 93).

The weirdness of St. Simeon’s dwelling on the column, his obsessive actions of bowing, the refusal of food except once per week, his stench and indifference to physical degradation: all took Simeon out of a comprehensible personal, subjective, and social realm and into a kind of pure “objectivity”. Peter Brown argues that his objectivity in relation to non-ascetic mortal men gave Simeon something of the strangeness and supra-humanity of an ancient oracle (Brown 1971): indeed, he became the mouthpiece of the Christian God, wielding power (*dúnamis*) as traditional authorities waned. The situation was not one of political decline and dilution so much as evolution, as a class of prosperous local farmers, townspeople, and the mobile men of the Roman army challenged the traditional pre-eminence of aristocratic elites. The *patronus* or local political patron remained a critical resource and protection, but in the fourth and fifth century came to be increasingly identified with the Christian holy man. The *Lives* of Simeon testify to the saint’s twice daily exhortations to those gathered below and the “judgments” he offered to local petitioners from 3:00 to 6:00 p.m. each day, between his long bouts of prayer (Doran 1992). Brown’s initial method was one that used religious sources against the grain: he sought not to illuminate the holy man himself but rather the society which he served, to which he was useful (Brown 1998a). In a later era of scholarship that had begun to attend to the body (Brown 1998b), he found his way to a richer account of *askesis*, Simeon’s rigorous performance of which was described by contemporaries in these terms:

He stood like a valiant man and was brave like a combatant and trained like an athlete and armed like a warrior in the army of the Lord (Doran 1992, 129).

## 2.0 ARCHITECTURAL PERFORMANCE: THE FUNCTIONS OF A COLUMN

Only one element of what is extant at Qal’at Sim’an dates to the life of Simeon himself: a heavily eroded part of a drum from the shaft of the column on which he stood (Fig. 2), which has now been displaced by shelling in Syria’s ongoing civil war.



**Figure 2:** Central octagon of the Qal’at Sim’an martyrion, showing the column base and part of one drum. Source: Menze 2015

All images of Simeon Stylites testify to the fact that, iconographically, the column is the core attribute of the saint: these include sculpted relief slabs (Fig. 3); handmade, handheld *eulogiai* (literally “blessings” created with dust from Qal’at Sim’an, their place of manufacture); manuscript illuminations; icons; and even graffiti (fig. 4) from throughout the Eastern Orthodox realm and beyond. Unexpectedly, in terms of medieval tradition, the site of the column at Qal’at Sim’an predominated over that of the saint’s burial—in the Cathedral of Antioch—as the primary locus of his cult (Eastmond 1999). In this way, the column as contact relic eclipsed the tomb, even as the column sometimes eclipsed the body of the saint in imagery (Frankfurter 1990; Menze 2015; Hunter-Crawley 2020).





**Figure 3:** Basalt relief of St. Simeon the Elder and a disciple (Berlin, Staatliche Museen zu Berlin). Source: Menze 2015

**Figure 4:** Graffito from a stable in Dayr Bashakuh, Syria. Source: Hunter-Crawley 2020

Why a column in the first place? What did it do for Simeon? The primary tool of his performance of virtue, it clearly became a visual synecdoche for his entire ascetic practice. Later, maintained by monks as an attraction for pilgrims, its architectural body stood in for his holy human body. In the introduction to his translation of the three *Lives* of Simeon, Robert Doran mentions an earlier scholar's description of Simeon as a "stationary" saint given to the ascetic feat of standing (*stasis*) in one place for long durations of time, something attested in the Syriac life and deemed in the late antique context of Neo-Platonic philosophy to remove one from the flux of becoming, bringing one into the realm of the transcendent (Doran 1992). But why stand on a column? And why an ever-higher column? Comparison with beliefs and practices in other ancient religions, and with other sites of architectural significance such as temples and triumphal structures, provides possible answers, as inventoried below. These range in turn from the anthropological/mythopoetic to the religious to the cultural-political to the visual and involve correlations of space, structure, spectacle, and society.

### 2.1. Axis mundi

Simeon's initial instinct was to go down, not up. He did not begin his individual asceticism atop a column: according to the Greek *Lives*, he earlier threw himself down a cistern, where he remained for up to a week; in the Syriac *Life*, Simeon dug a chest-deep hole in a corner of the monastery garden and stood in it, and later he spent Lent in a cave. When his fellow monks became irate at the extremity of his asceticism, he departed from the monastery to live for up to four years in a hut at the base of a mountain and, later, in the open air, chained to a rock at the mountain's summit. In short, he initially sought to hide himself in the earth or in a remote spot on its surface. Low drystone walls were built around him—for protection, perhaps, or crowd control—but Simeon still attracted more notice than was conducive to his spiritual practice. Only at that point did he choose the column as a device for alienation from the crowd, putting himself at a greater remove but at the same time making himself more visible. Following Mircea Eliade, Charles Stang remarks on the axis mundi that Simeon traces in his successive ascetic environments, rooted in the earth and later pulling free of it (Stang 2010). Art historian Heather Hunter-Crawley has interpreted even the salience of figural relief at the center of the upper convex curve of a small lozenge-shaped *eulogia* as a reflection of the axis mundi:

The token as a whole was a miniature icon of the whole saint, embodying the constituent parts of his personhood: his body and column, as an imprinted image; and the mountain itself, in the very material substance [and upward-curving form] of the token (Hunter-Crawley 2020, 277).

### 2.2. Elevation and transcendence

Depending on the account, Simeon changed column three or four times, rising from an initial height of 4-6 cubits (6-9') to a final one of 36-40 cubits (45-60'). The elevation—as on any high place—did not in itself distinguish him from other practitioners in other ancient religions; however, his gradual ascension took him to a place that was described by contemporary sources as "betwixt and between," the putative point where heaven reaches down to and touches earth. In this place, Simeon, "son of the resurrection," was regarded as breathing the air of the angels rather than that of mortals (Brock 1973). Here, as "a living icon of prayer ascending" (Harvey 1999, 108), he could serve as visible and audible medium for the descent of the will of God, like the Old Testament prophets before him (Harvey 1998). According to Evagrius, author of the early *Ecclesiastical History* covering the fifth and sixth centuries,

This man, endeavoring to realize in the flesh the existence of the heavenly hosts, lifts himself above the concerns of the earth, and, overpowering the downward tendency of human nature, is intent upon things above: placed between earth and heaven, he holds communion with God, and unites with the angels in praising him; from earth, offering his intercessions on behalf of humans, and from heaven, drawing down upon them the divine favor (Evagrius, cited in Doran 1992, 35).

### 2.3. Monumental pedestals

Columns are, of course, central structural and semiotic elements of much ancient architecture in the Mediterranean basin and the Near East. Although innovative Roman temples like the Pantheon in Rome inaugurated a new spatial condition for worship in a large congregational interior, made possible by the spans achieved with concrete and vaults, columns remained a signifier of dignified, monumental temple facades as those facades met their sites. In the East, at temple sites like Baalbek and tomb sites like Petra, where longstanding local traditions mingled with imperial Roman elements, columns were ubiquitous in a mixed architectural culture with roots in ancient Egypt and Persia as well as Greece and Rome. Simeon, like a portrait statue atop a triumphal column, would have been honored both by the elevation and simply by the architectural language of a significant, monumental pedestal. (Doran describes Simeon's platform atop the column as 6' per side, yielding an occupiable area of 36 square feet at the top [Doran 1992], but based on recent documentation of extant drum diameter [Schachner 2010], the platform atop the column may have presented an even smaller habitable surface.)

### 2.4. Pillar cults

More specifically and locally, single standing columns were placed before both pagan temples and Christian churches (Frankfurter 1990). For example, there were two pillars dedicated to Dionysus located in front of the Temple of Atargatis at Hieropolis, Syria that are sometimes cited in relation to the column of St. Simeon. According to the Roman author Lucian, they were put up to carry wooden statues but twice a year one of them was climbed by a real man who perched atop it for a week, bringing the petitions and prayers of petitioners to the gods. Simeon may thus have been heir to a practice of popular cults centered on pillars common throughout northern Syria in the Greco-Roman period and before. According to David Frankfurter, those cults themselves drew on Arabic traditions of the *baetyl*, a cult stone in holy places, often high places; the *semeion*, an upright, sometimes columnar, form associated with various pagan gods; and the "horned pillar" derived from the form of a standard bearing a crescent.

The combination of these various forms of religious representation ... persisting as basic to Syrian and Mesopotamian cultures well into the common era has a double relevance for Simeon the Stylite in the fifth century. ... it means that the pillar was a highly usual and traditionally significant emblem on which to place a holy figure in the cultural world of Late Antique Syria; there was no novelty to the pillar as an iconographic statement, particularly when the pillar was placed on a highly visible hilltop ... (Frankfurter 1990, 184).

However, as a *living man perpetually* atop a column, fixed between heaven and earth, Simeon posed a Christian counterpoint to both indigenous and imperial pagan practices (Eastmond 1999). He exemplified a moment when the multiple religious traditions of the Early Christian period begin to take on greater distinction (Finn 2009). Lukas Schachner points out that Simeon's pillar initially paralleled, then superseded, "one of the most eminent pagan highplaces of Roman Syria" at Hieropolis (Schachner 2010, 378).

### 2.5. Visibility and spectacle

Finally, the column made Simeon visible to others. Theodoret of Cyrrhus describes the column as God's stratagem for manifesting the holiness of Simeon and creating an attraction for other Christians (Doran 1992). Spectacle was thus an incontrovertible, if initially unintended, part of Simeon's flamboyant self-mortification. In contemporary terms, Simeon might be described as engaged in performative virtue from atop his high perch. Theodoret describes him as remaining upright atop his column even in death. When there was access to Simeon, it was by means of a ladder. Many *eulogiai* and other objects show an acolyte or disciple climbing a ladder to bring requests and prayers (and food) to the saint (fig. 3). The disciple carries a censer, indicating reverence for the holy presence of the saint. The angelic holy man remains fixed in place, moving only in repeated deep prostration, while others undertake the arduous climb to him. From atop his column, Simeon acted as both a new patron of those in surrounding society and an impartial judge. Brown points out that the wilderness of Syria was not true desert like that of Egypt—not one pole in a landscape of absolutes that gave rise to dichotomous thinking about Red Land and Black Land; instead, the Syrian "desert" (*eremos*) according to Brown, was always just at the fringe of scattered villages (*oikoumene*) (Brown 1971). It is telling that in the changing world of late antiquity a figure like Simeon could garner the fame he did: a man deemed dedicated to God alone, a man who lived an unearthly life but who yet, inevitably, was tethered to earth by his column shaft and by the webs of relations in which people depended on him to help them resolve conflict, pursue prosperity, and live a good life.

## 3.0 INSTITUTIONAL PERFORMANCE: THE ARCHITECTURE OF MEMORY

After Simeon's death in 459, his body was taken in solemn funeral procession to Antioch for burial, performing miracles even en route to the cathedral. By means of this translation of his remains, the saint was claimed for the larger church community and its liturgies. At the same time, the increasing penetration of Christianity into the Syrian countryside made it possible for the corporate institutions of the church to claim the site of Qal'at Sim'an as well, which evolved from a setting for individual devotion during a man's life to a place of broader spiritual power after his death, one which orchestrated public experience of that power via a sequence of architectural structures. In tracing the arc from one man's initial pious resistance to local society and custom (even the custom of local Christian monasteries) to his adoption into the canon of saints, Qal'at Sim'an is a significant example in the evolution of the power of holy men as managed and propagated by the church.

### 3.1. Creating a focal point

Despite the absence of Simeon's body, within a generation of his death construction began on a magnificent church (built between 476 and 490) and associated monastic buildings, together now known as Qal'at Sim'an or "Castle of Simeon" based on later tenth-century fortification of the site. At 440 yards long (almost the length of four football fields), the complex was grand indeed. The martyrium had a footprint equal to that of Hagia Sophia and is regarded as the most important Christian monument in Syria (Leeming and Tchalenko 2019). The church was built figuratively around the memory of Simeon and literally around the site of his final column, an aggrandizement the holy man might never have wanted but which the spectacle of his column invited, signifying a *locus sanctus* for the cult of the saint. Indeed, Antony Eastmond sees the distinction between handling of the body and aggrandizement of the cult site in the various early hagiographic texts: while the two Greek *Lives* emphasize the body of the saint, the Syriac *Life* (finished by 473) builds the reputation of the cult site at Telneshe in the years after Simeon's death (Eastmond 1999).

The necessity of a centripetal focus on the column set in mid-space and the desirability of visibility from multiple sides encouraged adoption of a centralized plan familiar from imperial mausolea. The church's octagonal form was rooted geometrically in Roman invention and programmatically in Early Christian baptisteries, themselves steeped in the symbolism of the tomb. (Indeed, preceding the martyrium and adjacent monastic buildings, on the only side by which approach over land is easy, is another octagonal structure, a large baptistery—the only octagonal baptistery in Syria [Krautheimer 1979, 152].) So important was it that the church be centered on the column, which was located close to the western edge of the hill, that the western parts of the structure had to be partly built into the rock of the site and partly on substructures and earthen fill that negotiated the steep topography (Leeming and Tchalenko 2019).

### 3.2. Accommodating the liturgy

The correlation of tombs and churches is familiar, but the implications for worship practice and spatial experience are less so. While memorial intentions dictated the centralized form of the martyrium, the liturgical needs of monks and pastoral/thaumaturgic needs of pilgrims no doubt suggested the three-aisled basilican arms that attach to the four long sides of the octagon. These provided ample space for a congregation of up to 10,000 worshippers facing the column and for circulation to and around it in worship. The enormous size of the church necessitated no fewer than 27 doors (Leeming and Tchalenko 2019), which also testify to the impulse to draw near to what had been ground zero for the saint's life and death.

### 3.3. Spatial invention

Although the basilican parts of the martyrium remain simple and distinct, an inventive and sophisticated spatial imagination is at work in the octagon with four of its arches facing the cardinal points, providing access to the central naves of the four basilicas, and the four other arches leading, on the diagonal, into trapezoidal chambers terminating in small apses. The octagon is steeped in the geometric verve of such earlier imperial Roman works as the centralized hall of Nero's Domus Aurea and the pavilion of the Piazza d'Oro of Hadrian's Villa at Tivoli. The building also preceded, by some fifty years, the better-known and more fluid integration of basilican and centralized plan types in Justinianic buildings such as Sts. Sergius and Bacchus and Hagia Sophia in Constantinople.

## 4.0 HISTORIOGRAPHICAL PERFORMANCE: ROME, SYRIA, CONSTANTINOPLE

We do not know how long a religious community survived at Qal'at Sim'an, but the surrounding area remained Christian during the early Arab conquest and into the period of the Abbasid caliphate (Leeming and Tchalenko 2019). The grandeur of the complex, the provision for monks who lived on site, and the welcome offered to pilgrims (who found not just religious buildings at their destination but also hostels for their lodging), marked it as a site of church-wide fame and spiritual prowess. The pious performance of the saintly body in pain (and glory) was remembered in its architectural accoutrement, which was later expanded into a monumental site within a sacred landscape of lesser destinations and the religious economy of pilgrimage. Even stylitism became domesticated after St. Simeon the Elder, with later monasteries having each its own stylite (Menze 2015). How have historians fit St. Simeon and Qal'at Sim'an into larger histories of late Roman and Early Christian architecture? Where do they belong within newer, less hierarchical and more decentralized models of architectural production?

### 4.1. Patronage

The size of the structures at Qal'at Sim'an and the quality of the spaces created have long suggested imperial patronage to scholars—an automatic and inveterate scholarly supposition in a conceptual universe that until recently saw quality as possible only at the hands of a wealthy elite. However, reliance on such interpretive assumptions began to fade when "the social turn" of historiography in the 1980s came up against long visible evidence of the sheer creativity of artistic expression in locations distant from a presumed center. Dale Upton has challenged architectural history's "reification of culture" through the example of late antique, so-called "late Roman" architecture at Baalbek, urging us to "start from Baalbek" rather than Rome in order to see more truly the contributions of different traditions in the hybrid forms long associated with the late Empire (Upton 2009). The "builder emperor" Zeno (474-91), deemed anxious to re-affirm his authority over the eastern provinces, is usually credited with financing Qal'at Sim'an, although the workmen are often descried as coming from Antioch, closer at hand. Richard Krautheimer tried to be fair in his magisterial Pelican volume on Early Christian and Byzantine architecture. Of Syrian churches just after 500, he noted on the one hand:

The monumentality of this Late Syrian architecture, the new organization of space and mass, and the rich classical vocabulary are without precedent in the local tradition.

On the other hand, he imagined influence working in a complex, nuanced way:

Imperial backing might well have led the Syrian builders to take a new look at the antique architecture of their own province, and thus towards a richer, more fully 'classical' vocabulary" (Krautheimer 1979, 165).

In all this, Krautheimer noted the beginnings of a new spatial aesthetic not unrelated to that exemplified by Justinian's churches in the capital city. Influence reaching from second- and fourth-century Rome to sixth-century Constantinople seems to have traveled paths through distinct and complex local cultures rather than flying directly over.

#### 4.2. The machine of imperial culture

Nevertheless, the Roman heritage of capacious volumes, the Early Christian clarity of longitudinal and centralized forms, and the ornamentation of the orders effected something that Simeon's column did not, indeed could not, alone: it brought the site from its fraternity with other local, indigenous sites into the orbit of the larger post-classical world. Simeon's asceticism may have been new but the structure of patronage relations was not. Simeon the patron to local farmers and villagers became himself the object of patronage, perhaps by an emperor. As has been argued with respect to the iconography of Early Christian representations of Christ, the co-option of a variety of local practices and images by an imperial machine of ritual, ceremony, and panegyric led to critical changes in representation and the eventual consolidation of new "imperial" forms.

Upton began with Baalbek. If we start with Qal'at Sim'an, we see a process of religious and social change that is more varied than theological and historiographical conceptions of religious conversion typically allow. When Upton describes the most significant parts of what he calls "Oriental Baalbek" with its focus on indigenous history, he points to the "high place" which lifted the temples above their surroundings and the open-air temenos in which the two tower-altars were located (Upton 2009). Such details help us to return to the original inspirations and sacred value of Simeon's column: unhoused, it rose on high, canopied only by the dome of the sky. It presented Simeon as a lightning rod for God's power come down to earth. If Roman Baalbek and Qal'at Sim'an are identifiable in the language of classical architecture, Oriental Baalbek and Syrian Qal'at Sim'an are evident in the space and use of the site.

#### CONCLUSION

Simeon was not an isolate: in fact, his legacy extends to some twenty stylites in the vicinity of Qal'at Sim'an alone in the 200 years after his death, not to mention famous other medieval imitators like Daniel the Stylite in Constantinople and Simeon the Younger at Antioch. In his long survey of late antique stylitism, Frankfurter notes that what was new with Simeon was not the column per se. Instead, it was the spatial liminality of being elevated and poised between heaven and earth (Frankfurter 1990). Simeon's column was his primary tool in the "craft of the [new, Christian] self" (Brown 1998b, 603). The column-top meeting place of two worlds was the locus of an individual's agency, even when the motivations of that agency remain opaque and the associated deeds incredible (Hunter-Crawley 2020). Such agency could, in turn, change society. The column remained meaningful as the contact relic that testified to Simeon's ongoing power of intercession and miracle-working in place. Architecture not only localized the holy for human perception, it also fostered the creation of meaning and memory around human activity. Simeon himself is described in late antique sources as "the wall" and "the tower" (Brown 1971). In an unstable society, the holy man, wall and tower, gathered and defended the faithful for a new God. In doing so, he displaced earlier sources of power in the classical period, the village wise woman as well as the aristocratic patron and the oracle.

Simeon's stylitism at Telneshe set a model for other stylites throughout Syria at sites that can now be mapped with GIS. The viewshed from each column often extended to the next column, creating a holistic sacred landscape unlike anywhere else (Schachner 2010). Not only was Simeon visible to others, they—travelers, pilgrims, and fellow stylites—were visible to him. Drawing on "a remarkable native ascetic tradition that went back to the very beginnings of Christianity" (Brock 1973), Syrian Christians at the "edge of the empire" in the fourth and fifth centuries were innovators in practices that spread broadly (the last of some 124 stylites is attested in the mid-nineteenth century) and commanded the veneration of centuries of worshippers (Menze 2015). As Stang notes, again citing Mircea Eliade, "we might understand saints as hierophanies that organize undifferentiated space" by means of a new "geometry" (Stang 2010). However, they did even more. St. Simeon and other holy hermits of late antiquity became a primary conduit for ethical guidance, political negotiation, and pastoral care at a time when municipal authorities were weak, aristocratic power in decline, and Christian bishops distant. Brown notes,

In Byzantium, there was a proliferation of little centres of power that competed with the vested hierarchy of Church and State. The clear outlines of the meticulously articulated imperial bureaucracy strike the casual observer of the Byzantine scene: but they were incessantly obfuscated by a fibrous growth of informal, unarticulated relationships—relations between patron and client, between spiritual brothers, between fellow godparents (Brown 1971, 95).

In the late antique period, when the church built its sites, it drew on and institutionalized the power of the local holy man; early on, it was he who, by virtue of personal example and spiritual charisma, did the regular work of governance and guidance. If, in Syria, the congealing of ascetic practice into the architecture of memory, celebration, and pilgrimage involved donning some of the architectural garb of Rome, it also helped to change the local architectural paradigm into one that was capacious and congregational: a public extravaganza of experience and sacred power focused on a single stylite's column but now connected to the broader currents of medieval Christendom.

## REFERENCES

- Brock, S.P. 1973. "Early Syrian Asceticism." *Numen* 20/1: 1-19.
- Brown, P. 1971. "The Rise and Function of the Holy Man in Late Antiquity." *Journal of Roman Studies* 61: 80-101.
- Brown, P. 1998a. "Asceticism: Pagan and Christian." In Cameron, A. and P. Garnsey, eds., *Cambridge Ancient History*, vol. 13: *The Late Empire, A.D. 337-425*, 601-31. Cambridge, Cambridge University Press.
- Brown, P. 1998b. "The Rise and Function of the Holy Man in Late Antiquity, 1971-1997." *Journal of Early Christian Studies* 6/3: 353-76.
- Doran, R., trans. 1992. *The Lives of Simeon Stylites*. Kalamazoo, MI, Cistercian Publications.
- Eastmond, A. 1999. "Body vs. Column: The Cults of St. Symeon Stylites." In James, L., ed., *Desire and Denial in Byzantium*, 87-100. Aldershot, Hampshire, UK, Ashgate.
- Finn, R. 2009. *Asceticism in the Graeco-Roman World*. Cambridge, Cambridge University Press.
- Frankfurter, D.T.M. 1990. "Stylites and Phallobates: Pillar Religions in Late Antique Syria." *Vigiliae Christianae* 44/2: 168-98.
- Harvey, S.A. 1998. "The Sense of a Stylite: Perspectives on Simeon the Elder." *Vigiliae Christianae* 42: 376-94.
- Harvey, S.A. 1999. "Embodiment in Time and Eternity: A Syriac Perspective." *St. Vladimir's Theological Quarterly* 43/2: 105-30.
- Hunter-Crawley, Heather. 2020. "Divinity Refracted: Extended Agency and the Cult of Symeon Stylites the Elder." In Gasparini, V., M. Patzelt, R. Raja, A. Rieger, J. Rüpke, E.R. Urciuoli, and E. Begemann, eds., *Lived Religion in the Ancient Mediterranean World: Approaching Religious Transformations from Archaeology, History and Classics*, 261-86. Berlin, de Gruyter.
- Kostof, S. 1995. *A History of Architecture: Settings and Rituals*. Second edition. New York and Oxford: Oxford University Press.
- Krautheimer, R. 1979. *Early Christian and Byzantine Architecture*. Third edition. Harmondsworth, Middlesex, UK, Penguin Books.
- Leeming, E.L. and J. Tchalenko, eds. 2019. *Notes on the Sanctuary of St. Symeon Stylites at Qal'at Sim'an*. Leiden and Boston, Brill.
- Menze, V. 2015. "The Transformation of a Sainly Paradigm: Simeon the Elder and the Legacy of Stylitism." In Blömer, M., M. Lichtenberger, and R. Raja, eds., *Religious Identities in the Levant from Alexander to Muhammed: Continuity and Change*, 213-26. Turnhout, Belgium, Brepols.
- Schachner, L.A. 2010. "The Archaeology of the Stylite." In Gwynn, D. and S. Bangert, eds., *Religious Diversity in Late Antiquity*, 329-397. Leiden, Brill.
- Stang, C.M. 2010. "Digging Holes and Building Pillars: Simeon Stylites and the 'Geometry' of Ascetic Practice." *Harvard Theological Review* 103/4: 447-70.
- Upton, D. 2009. "Starting from Baalbek: Noah, Solomon, Saladin, and the Fluidity of Architectural History." *Journal of the Society of Architectural Historians* 68/4: 457-65.

# Bangladeshi Immigrant Muslim Women's Memories from Past-lived Homes: Their Ways of Knowing Spaces

Mania Tahsina Taher<sup>1</sup>

<sup>1</sup>University of Wisconsin-Milwaukee, Milwaukee, WI

## INTRODUCTION

Philosophers and scientists explain 'memory' as the most extraordinary phenomenon in the natural world. Plato regarded memory as being like a wax tablet on which impressions would be made or encoded and subsequently stored so that we could return to retrieve these impressions later. Spatial memory refers to memory for the location of objects and self-orientation within the environment (Jackson, 2010). Many neurological, philosophical, and sociological studies confirm the strong relationship between memory and spaces even though their research methodology and goals were unlike. Architectural memory is often studied in terms of individual and collective experiences as a visualization of past places. An individual recollects spatial memories through coding, storing and recalling the remembered places (Ozak and Gokmen, 2019). Built environments serve as grand mnemonic devices that record and transmit vital aspects of human culture and their histories (Treib, 2009). Our built environment functions as a text or a narrative on this aspect which is often reflected through the accounts of spatial memories of its inhabitants. We construct what we know, and these constructions are deeply influenced by our early experiences and by the nature of our underlying relationship to the world. As the early experiences of women and men and their relationship to the world differ in significant ways, so too will their characteristic ways of knowing and analyzing (Franck, 1989). Many writers in the past decade have pointed out that women's underlying relationship to the world is one of the connection while men's is one of separation (Dinnerstein, 1976; Chodorow, 1978; Gilligan, 1979; Keller, 1985; Hartsock, 1983). This research reflects on a gendered perspective of memories from homes, and several queries come forward. What significance do people attribute to remembered spaces? How do the remembered spaces interact with them through multisensorial acts, such as- gaze, touch, smell, and, sound? Can spatial memories of past-lived homes add values to the current way of living? This research explores these questions to verify the memory-space relationship for Muslim immigrant women in the United States.

This study aims to investigate the importance of spatial recall in immigrant women's connection with their homes and its surrounding spaces. Although all immigrants- regardless of gender- pass through the same cycle of movement and reclamation of spatial identity, immigrant women encounter and establish a dynamic relationship with their visited spaces, mostly due to their racial and ethnic identity. From the narratives of the three Bangladeshi Muslim immigrant women, I came to understand that they knew each of their past-visited places as 'home' before they finally resettled in the United States. This research reflects on their spatial memories mostly inside their homes and adjacent places that were visible from inside these homes. Apart from the physical characteristics that shape the architecture of a dwelling, this is also the place where relationships among family members and their memories are prevalent. This study also testifies that their past place memories directly reflect on their present place experiences. In this way, this research reveals the importance of the formation of spatial memory in a Muslim immigrant woman's dynamic relationship with their inhabiting spaces.

## 1. Literature Review

This literature review largely reflects on the broader scholarly claims about memory and its relationship to space. This review also discusses refugees and their construction of place memories through erasure, movement, reclamation, and reproduction of space. At this point, the review focuses particularly on the scholarships of immigrant women's narratives of their past-lived places. and how these memories reflect their current placemaking.

### I. Memory, Space, and body:

This section begins with highlighting the formation process of memory inside the human brain and its relationship to the body system. Then, the study reflects on how this memory construction becomes a complex process in places like homes where human relationships and other factors also play their roles. From the early philosophers to today, memory is studied in various forms. The tripartite distinction of memory through encoding, storage, and retrieval have persisted among scientific investigators until the present day (Foster, 2008). Psychologists' studies show that the human brain perceives and remembers visual images of spatial location on the right side of the brain while the left side contains the narration of the events. Bastéa (2004) discusses this distinction between lived and learned memory of space which psychologist Schacter describes as 'body memory' and 'mind memory' respectively. The spatial memories derived from body experiences, such as- architectural layout inside the home and urban streets, are called body memory which is directly encoded in our bodies. The memories of learning spaces are called mind memories which human minds



experience through narrated experiences or from written texts and images. Bastéa further claims that the symbolic importance of objects, places, art, or language is transferred as memory. Following this notion, the spatial memory of a home for an individual is made up of many complexities. Dovey expresses that the living experiences of an individual inside a home are comprised of many abstract concepts. Inside a home, the spatial experiences and usage are often dependent on the relationships among individual family members who live at the same house. Age and gender of the home residents are also a crucial aspect of recalled different spatial experiences from memory.

II. Memory, space, and diaspora: Memory, in all its forms, physical, psychological, cultural, and familial, plays a crucial role within the contexts of migration, immigration, resettlement, and diasporas, for memory provides continuity to the dislocations of individual and social identity (Creet, 2016). Historian Frances Yates, in her 1966 book 'The Art of Memory' explains the importance of producing 'artificial memory to strengthen the natural memory. According to Yates,

"The artificial memory is established from places and images . . . A *locus* is a place easily grasped by the memory, such as a house, an inter-columnar space, a corner, an arch, or the like. Images are forms, marks, or simulacra of what we wish to remember... The *loci* remain in the memory and can be used again by placing another set of images for another set of material." (6-7)

She states that places as aids to artificial memory might be real or imagined and contain a strong emotional resonance for the individual. Yate's scholarship of 'true' and 'artificial' memory tied explicitly to place becomes further advanced by historian Pierre Nora (1989). He insists that place is the most natural of all locations of memory. He brings the concept of 'memory places' where "crystallizes and secretes itself" because we no longer have the 'real environments of memory'. According to Nora, unsullied 'real memory' exists only 'in situ', and the place is a stable, unchanging environment. Both Yates and Nora's investigation of memory and place explains memory as "what's forgotten is not an absence, but a movement of disintegration that produces an object of origin. In other words, memory is produced over time and under erasure" (Creet, 2016). Both of these thinker's claims about 'memory places' are pertinent to human migration discourses. For the immigrant people in movement, migration is the only psychological and physical condition of memory. The idea of 'place' for them often constitutes an important anchor of memory as a remembered or fabricated origin, or an origin made 'real' by matters of faith or custom. In both of these scholar's claims, there is little agreement about how place matters but they agree on the importance of location and local inhabitants for production of both the individual and collective memories. Thereby, place contains and accumulates several layers of memories proceeding from its change and remaking through times and events.

III. The Feminist approach to space: The organization of spaces in architecture has serious social, political, and cultural impacts that often reflect on women's position in space. Feminist philosopher Irigaray's writings point how space has been historically conceived to function either to contain women or to obliterate them (Grosz, 1991). She claims that the containment of women within a dwelling that they did not build, nor was even built for them, can only amount to homelessness within the very home itself. It becomes the space of duty, of endless and infinitely repeatable chores that have no social value or recognition, the space of the affirmation and replenishment of others at the expense and erasure of the self, the space of domestic violence and abuse, the space that harms as much as it isolates women (Irigaray, 1985). For women to be able to occupy space in a different way, it is clear for Irigaray that major transformations need to take place regarding women's organization of personal life; and also, the typical ideologies about their relationship with their living environment and nature. She also emphasizes that changes need to take place in theory and cultural production regarding women and the way their spaces are regarded.

By examining the daily lives of women from all cultures, it is possible to see that the home has always been a place of work for women (Davidoff et al., 1876). The culture of separation between the spheres of public/ private, men/women, work/home has made the women's everyday activities more difficult to pursue precisely because of the spatial distances that the ideology has generated (Hayden, 1984). As a result, closer spatial and visual connection between different spaces and activities has been a priority for many feminist designers and theorists, namely- Jane Jacobs, Susanna Torre, Eleanor Raymond, Dolores Hayden, and others. Connection and integration of spaces within the home have also been encouraged by female clients for many reasons, such as- the increase of everyday productivity, better personal relationship with others inhabitants, and, sense of personal liberation. According to architect Elizabeth Diller, in today's residence design, household chores can be incorporated into a daily aerobic regimen and performed to the beat of a television fitness trainer (Diller, 1996). She also claims that even though housework is slowly becoming less gendered and the discrete sites of 'work' and 'leisure' exchangeable, most conventions of domestic maintenance remain unchallenged.

IV. Immigrant women's minoritization in space: Michel Laguerre proposes minoritized space where the majority treats the minority group as a symbolic body. This body needs to be controlled, disciplined, segregated, subjugated, and dominated as a way of maintaining order and preventing them from polluting the larger part of the society (Laguerre, 1999). Immigrants in the United States have been treated as foreign bodies in a minoritized position. In the USA, the term 'women of color' is a socio-political designation for people of African, Caribbean, Asian, and Latin American descent, and native people of the land. Their oppositional political relation to sexist, racist, and imperialist structures

constitute their potential commonality which is more than their color or racial identifications (Mohanty, 2003). The immigrant women's lower position in the social power structure put them in a minoritized position where her body identity and socio-cultural practices are to be questioned and invigilated. While experiencing this sense of un-belonging, immigrant women are often expected to make choices of how much to assimilate into the new culture while trying to maintain a semblance of cultural identity (Crossman, 2006). This identity displacement for immigrant women is evident in Meena Alexander's poetry which evokes "a desperate search for lost homes and new homelands" (Shankar, 2001). Through her words, Alexander seeks to anchor her own diasporic identity in her adoptive country by wavering her past locations into the present (Sabo, 2016). Alexander's internalized sense of racial otherness and of carrying the colonial burden with her to the United States translates into her need to create a past 'in order to belong' and her belief that 'the task of making up memory' is 'the dark women's burden' (Alexander, 1996).

## 2. Research Methodology

In this research, I am planning to explore the memory-space relationship for Muslim immigrant women using unstructured interviews and photo-elicitation. I was also planning to add concept mapping as another method to elicit narratives about spatial memories. Due to this COVID outbreak, at this point, I cannot conduct these interviews in person. Thereby, I am planning to meet these participants through video meetings. I am proposing to select three participants who are not working and studying in Milwaukee. The reason behind choosing younger women as participants for this research is due to their proficiency in online communication during this emergency. This study aims to gain insight into the lived experiences of these participants inside their past-lived homes and their adjacent spaces.

The main research questions for this research project would be:

- I. What are the participant's lived experiences as a woman of color moving across transnational spaces?
- II. What are the structural essences of experiencing and remembering homes from the perspective of a young Muslim immigrant woman from Bangladesh?

In this qualitative research, I am planning to adopt a phenomenological approach to the implementation and interpretation of the research methods. Phenomenology is the interpretive study of human experience which aims to examine and clarify human situations, events, meanings, and experiences as they are known in everyday life but typically unnoticed beneath the level of conscious awareness (Seamon, 2000). Phenomenological methodology was well suited to explore the meaning these case studies make of their experiences. Phenomenology emphasizes the investigation of ways individuals construct their lives and make meaning of their experiences. This study reveals essential themes associated with the spatial memories of Muslim Rohingya refugee women before their final resettlement. These narratives of place memories might promote a greater understanding of the lived experiences of these women moving across transnational spaces.

### 2.1 Research Activities

- I. Unstructured interview: I am planning to hear from the participants through a two-phase unstructured interview. The interviews need to be planned through videos and phone calls. Both interview phases should be unstructured with specific prompts in mind that relate to the main research questions. The timeline for each interview should be ranging from thirty minutes to one hour. The data received from the first interview would be used to prepare the interview questions for the second-round interview. The second-round interview should be shorter, but no less than fifteen minutes. The interviews would be audio-recorded, transcribed, coded, and implemented to ensure that their memories have been accurately captured. This would also help to neutralize the interviewer's biases and preconceptions.
- II. Photo-elicitation: Photo-elicitation is a method of interviewing in qualitative research that uses visual images to elicit comments (Bignante, 2010). The main purpose of photo-elicitation interviewing is to record how subjects respond to the images and attribute to their social and personal meanings and values. The photo-elicitation process has been used only for second-phase interviews. The types of visual images that I have used for these interviews are photographs of their past-lived home and their surrounding places. These images required to have the physical substances that reflect on the spaces that they are going to talk about as memories from past places. This photo-elicitation part of the interview helped me to testify their spatial narratives from the first-phase interview.

## 3. Case study: Remembering Homes and Their Spatial Memory Narratives

As discussed earlier, a proposed spatial memory model has been tested with pre-set questions interviewed with three participants. The participants were all Muslim immigrant women from Bangladesh, and currently living in the different parts of the United States. They came to the United States with different purposes in life in different periods. Participant one (38 years) is an architect working for the NYC Building Department, currently living in Manhasset Hills with her three-year-old son and husband. Participant two (36 years) is a Ph.D. program student at biochemistry in UW-Milwaukee, currently living in Shorewood with her eight-year-old son and husband. Participant three (42 years) is a part-time sales assistant at Macy's, currently living in Friendswood, Austin with her two sons (13 and 9 years) and

husband. The narratives of their spatial recalls are collected and grouped under several key features that show similar consequences of their use of spatial memory.

### 3.1 Individual Features

The participants chosen for this study grew up in Bangladesh from different socio-economic backgrounds. In the United States, they all belong in the category of the middle-class economic group, and all of them are well-educated. The participants' ages range from late '30s to early '40s, and the difference between each of their current age and the age (period) which they want to recall is an effective timeline in recalling spatial experiences from memory.

Participant one recalls growing up at an apartment unit located in a large residential complex for government employees and their families to live. She lived all her life in Dhaka which is the biggest urban center and capital city of Bangladesh. She emphasizes in her narrative where both her mother and father were working as full-time researchers, and 'working mother' was not a common pattern in the '90s social context of Dhaka. She recalls growing up in that house from five years of age with her ten-year elder sister and two live-in housemaids who were treated as family members. She claims that having a working mother helped her to become more independent in life choices and everyday activities. She lived in that home till nineteen, and then, moved to her parents' owned apartment in a building where all the other apartments were lived by extended relatives from her father's side. Soon after they moved to their new home, her parents started to travel in between her sister living in the USA and their home in Bangladesh throughout the year. Participant one lived in that home for nine years before she went to study and live in London. In between the two houses where she lived her life before her journey as an immigrant began, she preferred to reminisce her memories as a young girl in her childhood house in the residential colony.

Participant two fondly recollects the openness and grandness of the inside and outside of the house where she grew up. She was born and lived in her parent's residence at a rural place called Fechania, in the Pabna district of eastern Bangladesh. In her narrative of spatial memories in and around that house, she reflects on the varying landscape around her childhood house containing fragrant flower plants, fruit trees and wooden trees. She says,

"The house was surrounded by Gardens. at the front and the back, there are two large yards. There were all kinds of flowers and plants in that garden. my mother's favorite plant was Madhobilata and Hasnahena. These two plants were located on the gate. there was a beautiful smell all year around our house".

Throughout her spatial narrative, she recalls the presence of her mom in the house who passed away in 2013. She also mentions her memories every time she talks about organizing her life around homes in Dhaka. For example, when she starts talking about organizing her new home after marriage, she says, "most of the utilities that I needed for my new home were organized by my mom. Even if I needed a tea sifter, I used to call her and ask her to send it for me from Pabna". It is interesting that when she narrates her everyday activities around her childhood house, she does not directly mention any activity that she used to do along with her mom, although her mom's memories are intricately weaved through her descriptions of that house.

Participant three mentions several times in her narrative about growing up in a family as the youngest of the three sisters and her parents. She calls back how her home was a place of care for her, saying "my eldest sister was twelve years older than I, and my immediate elder sister was six years older. We used to share a single bedroom even though there was an extra bedroom in the house. I used to sleep in the middle of my two sisters as long as they did not get married". Throughout her narrative of spatial memories, she recalls how her sisters played an active role through the everyday activities around the house. She mentions the memories of drenching in the rain and basking on the winter sun with her elder sister on the house roof. When she recalls spatial memories, she tends to emphasize more on the people and the activities in the space rather than the characteristics of the space itself.

The importance a home carries for the individual alone can differ significantly from the meaning it carries within a family set-up (Ozak and Gokmen, 2019). From all the participants' spatial memory narratives of their past-lived houses in Bangladesh, certain activities that relate to a family member's memory often appear more prominent than others. Participant one claims that to live closer to her parents and sister, she immigrated to the USA from the UK. She says, "Even though I was settled in London with my husband, I always wanted to move back to New York to live closer to my parents and sister. Now I cherish the fact that my son is growing up with my own family". Participant two and three also reminisces about the female family members that they grew up with while describing their past-lived houses. In their narratives, their childhood houses hold several layers of memories about the people and activities that they grew up with. In this way, their past place memories support Yates and Nora's previously discussed claims about place being an important anchor of their identity formation. Their childhood houses became the *locus* of their personal and family memories because place is the most natural of all locations of memory.

### 3.2 Physical features

The physical features of a house get encoded in a human body as part of their 'body memories' through their lived experiences in that space. While describing the physical characteristics of the house, the adjacent spaces (ex-

courtyards, gardens, playfields, etc.) also play a prominent role. In this research, the three participants adopted varied approaches in describing the physical characters of their past-lived houses. Participant one begins describing the location and layout of the residential colony where the childhood house was located. She first points out that the colony area was very calm and quiet despite being located in the heart of the city. From that point, she describes the central playground and other adjacent spaces around their building. In her recalling of the external landscape around her house, she emphasizes the activities that used to take place there. She reminisces on the memories of walking around the playground every day with her neighborhood friends. Her way of approaching through the outdoor spaces and her activities in there refer that the external setting of the house formed a very important part in her memory as the interior of the house.

Participant three also follows a similar approach as she also grew up in a residential colony in Gazipur, an industrial suburban area near Dhaka. She starts describing the playfield inside her residential colony and talks about how the young girls living there used to spend most of their time in that playfield. She says, "I was a very outdoor kid in my childhood. After getting back from school to home by two pm, I used to head towards the playfield to meet my friends. The playfield was a very big one in the middle of all colony buildings where all young people used to play in different smaller groups. None of us used to get back home until the Maghrib's azaan (the sunset prayer call for Muslims) was heard". She also mentions the playfield as a safe zone for everyone as the colony was a gated community. Both of these participants grew up in a house around a strong communal setting where they used to share outdoor activities with same-age friends. Their physical descriptions of houses starting from the playgrounds indicate that their memories of the open space and their activities there hold a very endearing place in their place memories.

Participant two takes a different approach from the other participants. She starts describing the private sleeping area of her childhood house on the upper floor. She begins with reminiscing about the raindrop sounds on the rooftop, and then, starts talking about her favorite area in the house. She describes the extended upper-floor balcony as her favorite place and describes her usual activities there: "I used to study in the balcony upon my mom's wish on weekend mornings when there is plenty of sunlight. ... from the balcony, I used to look at the surrounding garden. There were all kinds of flowers and plants in that garden. At the front and back of the building, there are two large courtyards". Later wards she reveals that she was not allowed from her family to play along with the neighborhood kids. Thereby, she describes the physical spaces around her house as the way she used to view it from the balcony but does not mention any particular activity in which she used to be engaged there.

The physical planning of the home appears to be an important element in respect to the memory being able to code spaces. The position of spaces according to each other, entrances, or streets are elements recalled relative to space. In all of the participant's conversation, the importance of the common activity zone gets prioritized. While describing the childhood house, participant one recalls the dining space as the heart of the house where family members used to sit, talk, and have dinner together after a long working day. In her present house, she still considers the dining and kitchen area to be the active space for the family on a busy weekday. She claims that while they are being active in a common area, that maximizes their family time:

"When we moved in the house, we were planning to use the basement family room as the kid's play area. We tried to keep our ground floor's living space as the formal living zone. Eventually, we figured out that if the kid plays in the basement, it is harder for us to access and watch over him. He is only three, he's too young to be there by himself. For example, I need to prepare food in the kitchen but my husband needs to be in the basement watching him play, and that misses out time among us. We have moved all the kid's play elements and converted the formal living as our family living room now".

She also mentions the advantage of their basement space to be not completely cut-off auditory and visually from their family living space, so that when extended family visits them on weekends, the young people's activities in the basement living space is not completely separated from the rest of the house. Interestingly, when she describes their family activity pattern in the earlier two-bed apartment, the joint living-dining-kitchen was the most active space. In their shift from a two-bed apartment to a two-storied house, their patterns of space usage around the common space did not change much except the presence of extended family members during the weekends. Participant two and three's description of space usage pattern in their current house also affirms the maximized use of a common family living and dining space. As discussed in the literature review, closer spatial and visual connection between different spaces and activities has been a priority for the women in the house as the house has always been a place of work for them. The participants' shared experiences of home activities from the past and the present testify this feminist approach to space.

### 3.3 Sensorial Features

Areas of interest within a space take a more detailed position in the place memories of an individual. In terms of spatial memory, senses play a very important role in the individual's perception of space. Senses like- gaze, sound, smell, taste, and touch reflect frequently in the spatial narratives of the three participants. Viewing out from the inside to the outdoor landscape was a prominent feature that they all touched upon while describing their houses. Participant one starts describing her residential colony with a large playground in the middle which is surrounded by large rain trees.

She recalls watching these trees from her bedroom's balcony as one of her favorite moments while describing her house. When she describes her current home in the Manhasset Hills, New York, she again refers to the view of her backyard from her kitchen as part of her personal 'morning moments' before the busy day gets started. She says,

"Just looking at the big backyard from the inside gives me a sense of calmness and leisure. there is a cherry tree in my backyard which is now on flowers. During this pandemic in New York when everything around is very stressful, it was a stress-relief view for me to look at the cherry tree and its flowers from my kitchen. I usually wake up early in the morning, take my prayers and then come downstairs for tea or coffee. It is my stress-relieving moment for the day when everything around the house is calm and quiet. I enjoy this moment in the kitchen looking out towards the back yard with flowers or birds while sipping the morning tea".

Participant two also talks about looking out to the surrounding garden landscape from the upper floor balcony of her childhood house. She also reflects on gazing out from her current home while she describes the street view from the kitchen patio:

"There is a small patio space attached to my kitchen facing Farwell Avenue. I think this is the best feature in our apartment which I appreciate very much, especially during the winter months when we cannot go outside. When the patio door is left open, we can hear the street sounds, and also, watch the street activities while standing on the patio".

While describing the gaze from inside their houses, the participants reflect on different feelings. For participant one, the views of the trees from both her homes provided her a sense of composure. Participant two describes the street view and the noise as a connector to the outside world from inside her home. On the other hand, participant three describes one of her cherished moments inside her childhood home when she used to read books beside the guest room's window. She says,

"the window was bigger in comparison to other windows in the house. That was my favorite spot for reading books. Someone planted a guava tree beside that and the top branch of that tree was right below the window seal. While looking out the window, I could see as far as my eyes go. I could even see my father's office building which is about three miles away".

When recalling spatial experiences, certain memories and activities appear more prominent than others. These gazing experiences above elucidate the participants' special moments from their house memories which also reflect on their favorite areas in the house.

## **4. Results and Discussions**

### 5.1 Individual Spatial Recalls

The participants frequently reflected on their family members and neighborhood friends while describing their recollections of space and the activities that used to occur in the spaces. The majority of these people remembered through spaces are the females who nurtured and cared for them, like- mother, sister, or grandmother. It is detected that behind all the spaces in the childhood home memories lie emotional connections. In a typical Bangladeshi Muslim family setting, the younger girls usually grow up along with the companionship of the senior females in the house as all of them live most of their time in the house. Thereby, a keen bonding of trust, respect, and companionship grows among the females in the house which get reflected in their space memories. Moreover, it has been observed that happiness is the most influential emotion in recalling past-lived spaces. Outdoor spaces and their activities, such as- courtyard, garden, and roof were described as places of vivid happy memories. Feelings of anxiety or fear were not heard in their told memories, but they mentioned several times that they used to be surveilled by senior family or neighborhood persons which used to make them feel safe in space. In all of their spatial reflections from homes in the United States, people other than family members and friends of Bangladeshi origin were not discussed.

### 5.2 Physical Spatial Recalls

Childhood home settings in Bangladesh are remembered as having playfields, courtyards, and gardens by the participants. They mostly associate these outdoor places with performed activities there, and also, as part of their visual recalls of everyday spaces. The organization of plans, floors, and spatial dimensions, construction materials, and circulation features play an important role in the recollection of spaces. All of these participants emphasized surveillance of common spaces as a major reason for maximizing their central and most visible spaces in the house. In their current space usage pattern, the more grown their kid has become, the less they feel the need to control and surveil their every move, physically or visually. Each of the participants stressed on the importance of easy accessibility to every space in their houses by all age groups.

### 5.3 Sensorial Recalls

It has been seen that the emotional connection formed with space is not only a perception formed through primary

visual and auditory media, but also from other senses, such as- smell, touch, and sound. In all the narratives, the most prominent sensorial reflection that every participant recalls are gaze. They reflected on their viewing outside of the house as a moment of personal reflection and stress release. Taste is at the very least influential in the recollection of space. Memories of rains have been fondly remembered in all of their spatial descriptions from the past.

## 5. Findings from the Research Methodology

In this research, I adopted unstructured interviews and photo elicitation as the research methods to receive information about the memory-space relationship of the three participants. I organized the questions in a pattern that followed throughout the interview while they were describing their current and past place memories. The first phase of the data collection method was only unstructured interviews with the three participants. Each of these interviews were at least one hour in duration, and they were asked around fifteen questions in this phase. I followed two different ways of organizing this interview process. As a first type, I started inquiring about their past places and ended the interview with queries about their current pattern of placemaking. The second type reversed the first one. In between these two patterns, I prefer the second one where the conversation started with questions that required the participants to describe their current placemaking and activities inside and around their home. The beginning conversations focusing on their present activities helped the participants to move better along the conversations as they could answer more in details about their current placemaking in the United States. By the time I moved on questions regarding their past place memories, they already understood the patterns of questions and it was easier for them to answer more to the point.

The second phase of the data collection process comprised of a follow-up interview on the earlier responses along with photo-elicitation which were at least thirty minutes in duration. This photo-elicitation part used photographs of their past places and inquired about the memories that these photos bring forth in their minds. In a way, this photo-elicitation process was testifying their responses from the interviews. I would suggest that this second phase of data collection method was validating the responses from the first phase, and also, added more details to the earlier responses. The time duration in between the first and the second phase for these interviews was about one month. In the meanwhile, I analyzed all the responses from the first interviews and decided on the inquiries for second phase about some of their place memories in particular. I find this overall process of organizing the data collection methods as effective, and the participants responded positively. A particular advantage that I received during this data collection process is that all of these participants chosen from my personal social group. Thereby, I was aware of much of their personal backgrounds along with their social, cultural and economic standing which helped me a great deal to prepare questioners and follow up with their answers. I would also claim that my personal experiences of being an Immigrant Muslim women living in the United States paved my way as a researcher here to better understand the experiences and place memories that the participants shared through these conversations.

While analyzing these interviews, I found three clear patterns in the participant's responses. First, a large number of their spatial recalls were related to activities along with their friends and family members, such as- playing football with younger brother in the front court of the house. I named these conversations and their findings as 'individual spatial recall'. This type of memories reflects on the point that place memories are often closely related to personal memories. Thereby, qualitative researchers, while doing interviews on place memories, should be aware of not crossing the boundary of comfort while asking about personal information and experiences of their participants. Second, a significant portion of these data reflected on the description of the physical characters of the places which I named as "physical spatial recall". One of the participants in this research is an architect by profession, and I felt her answers regarding the physical description to be very helpful and in line with the research goals. For the two other participants, I needed to guide them several times about describing the physicality of their places which eventually worked well. It was also interesting to find about the variation of responses and priorities that each of these participants put over their space usage. Third, some of their responses recalled to their sensorial feelings regarding the places which I organized under the category called 'sensorial recall'. Most of these sensorial recalls actually reflected on their positive vibes around these places. In this category, I received lesser feedbacks in comparison to the earlier ones but these recalls served as very good prompts to receive more detailed descriptions about their place memories.

## CONCLUSION

This research started with a projection that many of these spatial recalls might reflect on the participant's transnational displacement and their bodily disorientation in the current living environment as Muslim immigrant women. However, their place memories and current spatial experiences inside their homes could not hear much of that voice of disposition. There might be two mainstream reasons for these unheard spatial stories. First, homes are the places where their bodies and social identities are most at ease despite being identified as a minority in the new land. Second, each of these participants has a stronger social, educational, and economic background than majority of the Muslim immigrant women of color living in the United States. In the second-phase interviews, when they were inquired particularly on this question, all of them have acknowledged that they were mentally prepared to be considered as the 'others' in the everyday living environment of the United States long before their transnational journey took place. All of them acknowledge their current home as the place where their individual and ethnic identities need not be compromised.



Within the scope of this study, it can be said that each spatial memory narrative serves as a catalyst for further dialogue, debate, and research on the intersections of memory and space relationship for the diasporic women. This research proposed and tested the participant's positive and negative experiences with their homes. The methods adopted in this research analyzed how these experiences are coded in the process of memory recall, and also, how are they related in their current placemaking process.

## REFERENCES

01. Alexander, Meena. *The Shock of Arrival: Reflections on Postcolonial Experience*. Boston: South End Press, 1996.
02. Ardener, S. "The Partition of Space", *Women and Space: Ground Rules and Social Maps*, eds. by Shirley Ardener. London: Routledge Publishers, 1993.
03. Basteá, E. "Storied Cities: Literary memories of Thessaloniki and Istanbul", *Memory and Architecture*, eds. by Eleni Basteá. Albuquerque, NM: New Mexico University Press, 2004: 191-210.
04. Bignante, E. "The Use of Photo-Elicitation in Field Research: Exploring Masai representations and Use of Natural resources", *EchoGéo*, 11(2010): <https://doi.org/10.4000/echogeo.11622>
05. Boccagni, P. and Brighenti, A. "Immigrants and Home in the Making: Thresholds of Domesticity, Commonality and Publicness", *Journal of Housing and the Built Environment*, 32 (2017): 1-11.
06. Bourdieu, P. *Outline of a theory of practice*, transl. by Richard Nice. Boston, MA: Cambridge University Press, 1977.
07. Creet, J. and Kitzmann, A. eds. *Memory and Migration: Multidisciplinary Approaches to Memory Studies*. Toronto: University of Toronto Press, 2014.
08. Crossman, Sarah D., "'Tastes Like Home: Women Performing Immigrant Identity through Food". *Electronic Theses and Dissertations, University of Maine* (2006).
09. Daphne, S. *Gendered Spaces*. Chapel Hill, NC: University of North Carolina press, 1992.
10. Dovey, K. Home: An ordering principle in space. *Landscape*, 22 (2), (1978): 27–30.
11. Duncan, N. *Bodyspace: Destablising Geographies of Gender and Sexuality*. London: Routledge Publishers, 1996.
12. Dyck, I. and Dossa, P. "Place, Health and Home: gender and Migration in the Constitution of Healthy Space", *Health & Place* 13 (2007): 691-701.
13. Franck, K. A. "A Feminist Approach to Architecture: Acknowledging Women's Way of Knowing", *Architecture: A Place for Women*, eds. by Ellen P. Berkeley, Washington D.C.: Smithsonian, 1989.
14. Grosz, E. "Women, Chora, Dwelling", *Architecture and the Feminine: Mop-up Work* (1994): 4:22-7.
15. Hall, S. "Cultural Identity and Diaspora." In *Identity: Community, Culture, Difference*, edited by Jonathan Rutherford, 222–37 (1990). London: Lawrence & Wishart.
16. Irigaray, L. *Speculum of the Other Women*, trans. by Gillian C. Gill. Ithaca, NY: Cornell University Press, 1985.
17. Laguerre, M. *Minoritized Space: An Inquiry into the Spatial Order of Things*. Berkeley, CA: California University Press, 1999.
18. Mallett, S. Understanding home. *The Sociological Review*, 52(1), (2004): 62–89.
19. Mcleod, M. "Everyday and 'Other' Spaces", *Feminism and Architecture*, eds. by Debra Coleman et al. New Jersey: Princeton Architectural press, q997.
20. Merleau-Ponty, M. *Phenomenology of Perception*. Transl. by Donald Landes. London: Routledge Publishers, 1962.
21. Mohanty, Chandra T. *Feminism Without Borders: Decolonizing Theory, Practicing Solidarity*. Durham, NC: Duke University Press, 2003.
22. Ozak, N. and Gokmen, P. "Spatial Memory: A Childhood House a Proposed Model of the Memory and Architecture Relationship", IOP Conference, Material Sciences and Engineering, 603 022026.
23. Sabo, Oana. "Creativity and Place: Meena Alexander's Poetics of Migration", *Interdisciplinary Literary Studies*, Vol. 18, no.1(2016): 67-80.
24. Scott, Joan W. "Gender: A useful Category of Historical Analysis", *The American Historical review*, Vol. 91, no. 5 (1986): 1053-1075.
25. Seamon, D. "A way of seeing people and place: Phenomenology in environment-behavior research", in *Theoretical perspectives in environment-behavior research: Underlying assumptions, research problems, and methodologies*, eds. by S. Wapner, J. Demick, T. Yamamoto, & H. Minami, (2000): 157–178.
26. Shankar, Lavina D. 2001. "Postcolonial Diasporics 'Writing in Search of a Homeland': Meena Alexander's *Manhattan Music*, *Fault Lines*, and *The Shock of Arrival*." *LIT: Literature Interpretation Theory* 12, no. 3: 285–312.
27. Treib, M. "Introduction" in *Spatial Recall: Memory in Architecture and Landscape*. London: Routledge, 2009.
28. Weintraub, J. and Kumar, K. *Public and Private in Thought and Practice: Perspectives on a Grand Dichotomy*. Chicago: The University of Chicago Press, 1997.
29. Yates, F. *The Art of Memory*. London: Routledge & Kegan paul, 1966.

# Towards a Post-Anthropocene Bio-Design Practice

Assia Stefanova<sup>1</sup>

<sup>1</sup>Newcastle University, Newcastle upon Tyne, UK

**ABSTRACT:** The paper seeks to identify two different epistemological approaches within bio-design that have emerged as a result of historical and scientific influences, which are differentiated by methodological, linguistic, and ethical factors. The paper examines how such differences impact the design process and proposes a framework for eco-centric design thinking. Biological processes and living organisms have entered the fields of architecture and design, offering new solutions to ecological problems. In employing other species within the built environment, ethical implications for working with living organisms arise. The attitudes and methods adopted within the field of bio-design can be traced back to our historical relationship with nature. Humanity's views on nature and the environment were radically redefined during the Enlightenment, adopting a mechanistic framework, depriving nature of its agency through a virulent rejection of mysticism, animism, and the Earth Mother image. These views were strengthened by the Industrial Revolution and later, 20<sup>th</sup> century practices enabled mass production and gluttonous use of finite natural resources. Within design these mechanistic principles have been applied in the field of bio-technology that is at the service of humanity, being integrated into the built environment in a similar way to inanimate matter. At the other end of the spectrum lies a non-anthropocentric bio-design practice that is based upon pre-Enlightenment thinking and the shift in rhetoric brought about by research into animal sentience, symbiosis and Gaia theory, which highlights human participation in complex interspecies networks. This ecological discourse postulates new modes of thinking within the field of design, placing humanity within a multitude of interdependent relationships, highlighting the need for human responsibility towards living organisms in the built environment and bringing forth a different set of ethical considerations within bio-design practice.

**KEYWORDS:** bioethics, ecocentrism, living materials, ecology, bio-architecture

## INTRODUCTION

The microbial world has historically been classified within two distinct categories of either helping and more so serving humanity or threatening our existence in the form of biological weapons, undesirable mutations, and pathogenic species. This rings particularly true during the time of the global COVID-19 pandemic and the drastic measures taken to prevent the virus from propagating by imposing changes on our physical environment, social activity and relationship with our body (Lorimer 2020). When addressing the desirable aspects of microorganisms, we enter the conversation of curing diseases, addressing human problems or needs and increasing profit margins. These prevalent attitudes could be classed as both anthropocentric and patriarchal in their notion of governance, control, and mass production. In order to design ethically with living organisms, we need to examine our relationship with the living realm and identify areas of responsibility, dangers within designing from a flawed premise and establishing if it is in fact possible to recognize the living microorganisms, we employ in our making practices as morally considerable in their own right.

As designers we are inevitably seduced by advancements in science and through our collaborations with scientists and researchers we embark on journeys in search of novel solutions to current problems. In such collaborations, at times the end justifies the means or opens up uncharted territories of co-creation between designers and scientists, humans and non-human species. However, in our pursuit to innovate, create and develop more efficient ways to produce on a large scale the work of the designer becomes a destructive to the planet endeavor (Fletcher, Pierre, and Tham 2019). Production does inevitably contribute further to the amount of waste, pollution, and resource depletion, fueling consumerist, capitalist objectives. As such the designer becomes unwillingly an integral actor within processes that have transitioned our human existence from a Holocene era to what some refer to as the Anthropocene. This is a time where human activity leaves a significant mark on the planet, through changes that are registered globally. When fabricating with living things, it is important to remember that unlike inanimate matter, when working with these new materials we rely on their ability to process waste, respond to environmental factors, carry on developing in a healthy manner, multiply, form communities and adapt to local conditions. This is behavior not dissimilar to our own.

As designers we engage in making practices that range from curating conditions for desirable development of living organisms to synthetic biology, a practice of genetic modification for design purposes, with some practices enlisting living biota as laborers rather than as partners. This paper does not propose a return to a simpler past, strict governance or rejection of certain types of scientific practices, rather it postulates a reframing of the narratives surrounding bio-design and a more expansive discussion in relation to design objectives. This paper builds upon existing bio-design

frameworks such as the one proposed by Carole Collet, that identifies a hierarchy of bio-design practices; nature as a model, nature as co-worker and nature as a 'hackable' system. Collet goes on to define two distinctly different types of designers, the 'designer cultivator' and the 'designer biologist' (Collet 2020). In this paper we are going to look at the different premise of such bio-design practices, interrogating the range of intentions underlying different types of making in relationship to their historical and cultural origins. The paper identifies a framework for post-Anthropocene bio-design practice that defines a way for reframing our interaction with the natural world in the context of working and co-habiting with living microorganisms.

## 1.0 TECHNOLOGY AND NATURE

### 1.1. Mechanistic Views of Nature in Biological-Techno Futures

Current standards for scientific knowledge are rooted within definitions set by the mechanists of the Enlightenment period. They still govern modern definitions of true knowledge and our value system associated with obtaining knowledge through scientific means opposed to observational or philosophical methods (Merchant 1980). This is evident in Francis Bacon's *The New Organon* where he endorses a hands on approach, justifying intrusive interrogation of nature (Bacon 2000) in line with Kantian ethics defined a century later that denied the moral considerability of non-human life. During the 19th century mechanistic views of biology gained popularity and were supported by prominent scientists of the time. Examples include Theodor Schwann who furthered human understanding of cells and studied how basic building blocks compose complex structures (Schwann 1847) an idea prevalent within engineering and applied to living organisms. Around a similar time, Hermann Helmholtz argued for the civilizing power of science (Helmholtz 1885) and Rudolf Hermann Lotze supported the idea that the world was governed by mechanistic principals (Benaroyo 1998; Lotze 1848).

The 19<sup>th</sup> century also saw a growing relationship between scientific practice and the integration of nature in a structured scientific investigation, where the treatment of animal subjects was considered in terms of ethics. Pioneers of the mechanistic view of biology such as Carl Ludwig a notable physiologist of the 19<sup>th</sup> century encouraged careful consideration and care when using animal subjects, requiring a clear reasoning for conducting such experiments and minimized suffering (Chisholm 1911). Later on Jacques Loeb interpreted living organisms as living machines largely sustained through chemical processes that could be replicated outside the body, avidly supporting the shift of biology form a science of observation to a discipline of control and manipulation of natural organisms (Loeb 1906, 1912). In the early 20th century this mechanistic optimism aspired to the artificial transformation of inanimate matter into living matter and the editing of living organisms. Borrowing principals of knowledge acquisition through making, widely employed in chemistry, to interrogate nature has become an approach deeply embedded within synthetic biology (Bensaude-Vincent 2013) where mechanistic views have permeated the field. Grandiose speculations of previous generations of scientists, still inspire both researchers and creative practitioners.

The new practices that emerge, engage in a similar rhetoric of modifying organisms to solve problems or creating life in the lab by simplifying organismal complexity into separate functions that can be systematically categorized and rearrange to program behavior and properties (Ramirez Figueroa 2018). Many analogies have been drawn to explain living organisms, including digital programming, mechanical parts, LEGO blocks, that refer to unit-based construction. One such example is BioBricks by MIT, a collection of DNA sequences a library of parts that can be assembled to produce larger units that can be inserted into organisms such as bacteria (Knight 2005). Such narratives appeal to designers as they employ models that are close to the design fields and that can be easily integrated within a traditional design practice. These models typically engage in speculative bio-technical utopian constructs where living entities perform functions useful to humanity or even negate damaging human impact. The former raising questions as to the anthropocentric attitude towards non-human life and the latter releasing humanity from accountability of actions pertaining to the natural environment, sending a reassuring message that solutions rest outside of our own agency.

Similar to scientific research into ways of making other planets habitable as a distant backup option (Aronowsky 2017) the notion that we can engineer other species to act as tools for solving human problems further reinforces the subjugation of nature and permits ungoverned by ethical consideration human development. Yet, there is a wide spectrum of ecological thought that proliferates the field of bio-design. Whilst a great incentive for such endeavors is rooted in capitalist objectives that at times fail to take the wellbeing of humans or nature into account, there is also the current reality of drastic changes that have been caused by human activity, where solutions may not emerge in time if left to nature alone. Solutions to problems become a driver for projects that investigate the use of genetically modified microorganisms to resolve issues such as coral bleaching due to global warming (Cornwall 2019), modified microalgae that can breakdown waste in sewage treatment plants (Hallmann 2007) or bacteria that can degrade plastics (Ben-Gurion University of the Negev 2016).

Engineering principals are applied to biological systems, in an attempt to standardize and assemble living things in the same way that mechanical machines are manufactured. This standardization is also key to mass production, by eliminating variation and complexity we can feed biological processes into the capitalist production line. However it is not only the editing of organisms but also the creation of life that is essential to such a system, in *Tomorrow's*

*Biodiversity*, Vandana Shiva identifies the reproductive process as problematic for capitalism as it is uncontrolled and therefore problematic for commodification (Shiva 2000). It poses the difficulty of consistency as well as controlled distribution and exclusivity (Langill 2009). This freedom is edited out of nature in many ways through genetic commodification by editing out the reproductive ability of the new species or cloning, which produces genetically identical, even though not visibly identical replicas. Some may argue that these practices are similar to many practices that humans have employed throughout the centuries such as grafting of certain fruit bearing trees to ensure consistency. However if we look to the rhetoric surrounding these new practices it becomes apparent that aspiration surpass the limits of husbandry, Robert Carlson goes as far as to define “biology as the oldest technology” (Carlson 2011). Such mechanistic terminology permeates bio-design practice and is indicative of an underlying attitude to nature and its role which in many cases is instrumental rather than co-creative. The term *bio-technology* has become synonymous with working with living organisms. Yet, it specifically defines living organisms as tools without agency, in the same way manmade contraptions serve a purpose for the benefit of humanity and often more precisely economic interests within an ever-growing bio-economy.

Such problem-solving freedom, that promises endless possibilities has enticed designers and creative practitioners who oftentimes speculate as to the design possibilities of new species created for the service of humankind. Examples include speculative projects that imagine genetically modified organisms that can tackle human needs. They postulate speculative techno futures that envisage a new era in design where biology can be enhanced, modified or integrated into engineering to fix the problems of the previous era of industrialization. This builds on the existing model of growth and progress, bringing a level of optimistic belief that technology will save us and that we can continue to develop in a similar trajectory. Project such as the creation of trees that glow in the dark and have the ability to eliminate the need for street lighting have captivated the public and designers such as Dann Roosegaarde. In his collaboration with Stony Brook University, he investigates inserting the bioluminescent gene present in luminescent marine bacteria into terrestrial plants (Woodyatt 2020). The prospect inspires optimism in the current context where lighting accounts for 15% of world electricity consumption (Dreyfus and Gallinat 2015). This new technology proposes an urban realm where Nature 2.0 emerges as a means of reestablishing human activity as benign factor in the ecosystem. This new collaboration builds on existing work by Studio Roosegaarde, entitled *Glowing Nature*, an exhibit that utilizes natural bioluminescent algae that emphasizes the relationship between nature and technology alluding to a future where human/ non-human interaction will become a part of everyday life (Roosegaarde 2017).

Along a similar thread, living wearable exhibit *Bio-Lum-Sac* by BioBabes ventures into a less anthropocentric, premise of microorganisms and humans co-creating mutually beneficial environments for survival in an abruptly changing ecological landscape. The exhibit utilizes alginate bioplastic and *Pyrocystis*, a bioluminescent algae to create a wearable life-support system that presents the human body as habitat for another species that in turn benefits the host, highlighting a healthy codependency (Arnardottir and Dias 2020). The exhibit builds upon other bio-fashion works that look for ways of manufacturing sustainably by using natural organisms and their byproducts. Such works include Suzanne Lee’s *BioCouture* that proposes the use of bacterial cellulose to create biodegradable clothing and MicoWorks’ mycelium leather. There are also speculative projects that explore our relationship with nature such as Neri Oxman’s *Wanderers*, a work that consists of wearable 3D printed vessels that are implanted with microorganisms and Carole Collet’s *Biolace* speculative bio-design work that imagines genetically modified plants that produce lace structure root systems. Such works offer a take on edited nature as a fantastical future that tackles the polluting practices of the textile industry through a new flora. They are representative of a bio-technical future that carry both the promises of salvation through science and the uncertainty of the presence of a new type of nature.

## 1.2. Life Creation vs. Life Management

The traditional scientific view has identified life creation as an aspiration and currently through synthetic biology practices we have been able to create new species, although “creating” life from inanimate matter still remains a mystery. As far back as 1880, Emil du Bois-Reymond, whose work laid the foundations for modern neuroscience (Finkelstein 2013), proposed the origin of life as a question humanity is yet to answer (Jr. 1965). Ideas of life creation have been embraced by many creative practitioners, artists and bio-designers through engaging with scientific practices such as genetic modification or creating life-like behavior in inorganic matter as is the case of protocells, speculation as to the origins of life from inorganic matter (Armstrong 2015). Certain art and design practices embrace the scientific processes in speculative manner such as Meat House, a project by Mitchell Joachim (Tandon and Joachim 2014) imagining the house of the future as a growing organism composed of living flesh. Similarly, the art installation *Victimless Leather* explores the use of tissue culture to grow a miniature jacket as a demonstration of growing animal products for human use in a petri dish (Catts and Zurr 2004). These attempts are often interpreted as a means of undermining barriers between humanity and nature as argued by bio artists Catts and Zurr who also acknowledge that “on one hand we attempt to break down specism and make humans part of a broader continuum. On the other hand, we artists-humans, are using (abusing?) our more privileged position to technically manipulate an aesthetic experiment.” (Zurr and Catts 2004). Creative practitioners bring debates regarding emerging scientific practices into the social realm, at times choosing to engage in the methods they wish to critique. However, those boundaries become blurred and so do the objectives that drive the work. Examples emerge within transgenic bio-art, where practitioners such as Eduardo Kac claim to be the ‘creators’ of living organisms, and the idea of mastery over nature becomes clearly

evident in the relationship between the practitioner and the living organism (Bryant 2009).

Mechanistic and holistic bio-design practices differ greatly in their core objectives, both practices manipulate nature and look to natural processes, to inform their methods. However, whilst we can look at creating new types of lifeforms to operate in a manner we desire, a holistic approach often looks at creating environments for other species to develop. Hence the conditions for life to occur become of greater importance as well as the other organisms that in a natural setting would co-habit with the desired species. Therefore management of living biota becomes a necessary part of the design process. In nature death occurs as part of the creation of life, cells are eliminated in a form of natural subtractive manufacture to create form just as cells are created to generate multicellular lifeforms. This process of programmed cell death known as autophagy is necessary for the removal of malfunctioning cells or the removal of unnecessary cells as if the case with the formation of a fetus. A balance between species occurs in nature and it is within this frame of thought that we can begin to justify managing living biota, preventing some species from taking over and encouraging others. This goes beyond a gardening practice as it engages in revising human/ non-human relationships in an age where we have actively excluded living biota from our habitats and have created narratives of hygiene that we have only recently come to question. The non-anthropocentric thinking that underpins holistic design practices supports the notion that nature is neither good nor bad and recognize that such dichotomy does not exist within natural networks, but only in relation to particular actors. Within a non-anthropocentric design approach, the challenge remains of maintaining a fine balance where we do not excessively or unnecessarily interfere with natural networks. For example, when looking at algae and cyanobacteria we are faced with over 70000 different species (Guiry 2012), each one adapted to specific environmental conditions ensuring its survival. Out of this wide natural multiplicity we are able to single out organisms that perform functions that can help improve our artificial built environments. In the author's work with photosynthetic bio-composites, natural algae species are integrated into building materials to sequester carbon dioxide from the air whilst using human and industrial waste as a nutrient alternative (Stefanova et al. 2020). Although the work enlists living microorganisms to address sustainability challenges within the built environment, the process of working with the limitations of the organism and a firsthand experience of the fragility and responsive behavior of this new type of materials fosters a greater appreciation and recognition for the living organism within the design practitioner.



**Figure 1.** Architectural photosynthetic bio-composites on various types of substrates. Work done as part of PhD research by creative practice in Architecture in collaboration with Dr Gary Caldwell's Lab, School of Natural and Environmental Sciences, Newcastle University. Source: (Author 2020)

### 1.3. Simple Building Blocks vs Complex Networks

For a long time, scientific discourse has placed great importance on self-sustaining systems that function in isolation, stable and divorced from interactions and changes, projecting a sense of stability much like a mechanical system that is the sum of its parts. However, such equilibrium does not exist in nature as it is predicated on a lack of encounters or change, which is impossible to maintain and greatly detrimental to life on the planet. Our own DNA along with every cell in our body is a testament to the importance of co-creation through species interaction. Our DNA originating from the interaction between viruses and the parts of our human cells being made up through bacterial encounters (Tsing 2017). James Lovelock and Dian Hitchcock tasked with developing life detecting equipment for NASA's 1975 Viking mission to Mars speculated that it is life itself that was responsible for the hospitable atmosphere of our planet in comparison to other planets such as Mars and Venus (Hird, 2009). This is in line with Gaia theory which supports the view that life is responsible for regulating the planet's conditions, moulding them to facilitate the existence of a complex network of living organisms in essence making the Earth a living self-regulating entity. Major aspects of Earth's make-up are now attributed by some scientists such as Stephan Harding and Lynn Margulis to living organisms, such as the large amount of water found on our planet or weathering of rocks which could be attributed to the activities of bacteria (Harding and Margulis 2009). This set of ideas align more closely with pre-Enlightenment views of the Earth Mother image, a notion that served to manage human activity through a set of ethical considerations and a belief that there



were direct repercussions for intrusive actions against nature (Merchant 1980). These lines of thought have become central to works that seek to understand living organisms and accommodate them into our manmade building realm. In architecture this manifests as designing environments for other species to reside in, that act as life support systems in spaces that were designed to support a single organism. Multiple actors come together in the exhibit *Yggdrasil*, a collaborative work by the author and bio-designers Thora Arnardottir, Dilan Ozkan and Sunbin Lee, presented at London Design Festival, 2019 to highlight the fragile nature of the living organisms we enlist in bio-design. Each piece enclosed in its own individual container sustained living, breathing microorganisms. For the duration of the exhibition these pieces lived under their own protective cover, creating condensation at the dividing barrier, reminding visitors that each piece carries life with its own dynamic processes. The pieces incorporated four different types of organisms that have the potential to be integrated into the built environment at various stages of the building's lifecycle including: mycelium, bacterial cellulose, biomineralizing bacteria and photosynthetic microalgae (Stefanova et al. 2019).

Whilst the previous example employed the living organisms to demonstrate the live behaviour of those species, other holistic bio-design works use proxies to generate engagement and awareness of the natural networks around us. An example is *Crochet Coral Reef* a work initially created by Margaret and Christine Wertheim who used their expertise in making and mathematics to create a crochet sculptural exhibit to highlight the effects of pollution and human activity on the coral reefs. Since then, a Satellite Reef program has brought together over ten thousand practitioners worldwide who have used various materials and similar methods to participate in this global effort to raise awareness (Wertheim and Wertheim 2020; Haraway 2016). Another example is *Mitochondrial Matrix* (Figure 2) a work created by the author that studies the symbiosis between mitochondria and mammalian cells and its subsequent integration into every cell in the human body through symbiosis. The work is created in collaboration with the Wellcome Centre for Mitochondrial Research, Newcastle University as an interdisciplinary project for raising awareness for mitochondrial disease and its impact on patients. The exhibit uses clay 3D printing and traditional glazing techniques to create a collection of three hundred ceramic pieces based on a simple geometry and growing incrementally in complexity to symbolize cellular changes and development. It enlists the design skills of the practitioner to overcome the inaccessibility of the scale on which those changes occur and bridges the gap between scientific understanding of the disease and the human experience.



**Figure 2.** Mitochondrial Matrix, work in progress, installation done in collaboration with the Wellcome Centre for Mitochondrial Research, Newcastle University as part of PhD research in Architecture. Source: (Author 2020)

## 2.0 POST-ANTHROPOCENE BIO-DESIGN PRACTICE

The precarious nature of life in the Anthropocene as defined by Tsing (Tsing 2017) calls for a holistic or a post-Anthropocene bio-design practice that revisits the established position of humanity within the wider natural network. This type of work is very much underpinned by reframed definitions and objectives, that not only manifest in the outcome but are more clearly expressed in the making process and the conversations surrounding making. This type of practice acknowledges a search for ways of co-existence in a rapidly changing landscape rather than limiting it solely to the development of new technological solutions. We can breakdown the five key components of such practice as follows:

### 2.1. Microorganisms as Co-Creators

As designers we are continuously making choices as to the practices we engage in, within bio-design our work rests on the intersection between science and humanities, bringing an ethical element into the process of working with living organisms. This assigns a level of responsibility with the creative practitioner to enter dialogues and to clearly determine objectives. In a holistic practice the emphasis shifts from creating designs that serve human needs to considering a wider web of actors, recognizing that when enlisting living biota, we are inevitably creating relationships that have a profound effect on the human as well as their non-human counterparts. This type of practice is rooted in scientific



thinking that looks to ecological networks and is present within Gaia theory, symbiosis and moral considerability of living things. It is not a practice of exclusion rather it is a practice of greater consideration for the wider whole and that seeks integration into live environments.

## 2.2. Use of Language

Language is instrumental and is not only indicative of one's attitude towards nature, but it also sets out an agenda for the investigative process. Within design we often borrow terminology that originates in scientific and more specifically mechanistic frameworks and surrender our agency as designers, rather than define a terminology that is reflective of our intentions. Haraway looks at the use of language and identifies *thoughtlessness* or a lack of deeper reflection in regard to human activity (Haraway 2016). Therefore, the terminology surrounding these new types of design have to be carefully considered to reflect an inclusive and non-anthropocentric attitude. This brings into question references to *manmade technology* when talking about the emerging living building realm, bringing into question both the patriarchal promise of mechanistic concepts and the role of nature as means to an end.

## 2.3. Active Collaborative Role

Bio-design practice is reliant on interdisciplinary collaborations often between scientists and design practitioners where the work of the designer varies depending on the type of approach that the designer assumes. It is important for designers to understand the organisms that they work with, so as to acquire an understanding of the limitations and the plausible design solutions and to gain an appreciation for the lifeform that they choose to enlist as co-creators. This stipulates a role that goes beyond curating existing science and relies on the exchange of knowledge and skills across science and design so that the designer can help in shaping the direction of development with a holistic environment in mind.

## 2.4. Public Engagement and Social Responsibility

By introducing living organisms into the built realm, we are creating relationships between the public and biofilms, challenging existing definitions of living biota in the home and creating new hybrid environments. Therefore, projects that encourage interaction and propose a different understanding of the natural world, that emphasize the agency of these microorganisms become of great value in reshaping the social realm and thinking surrounding bio-design, to accommodate living organisms in a similar way to practices that reshape the environmental conditions for natural processes to occur. This type of work does not necessarily incorporate the living organisms but cultivates a different understanding within the public.

## 2.5. Co-Creative Narratives

The construction of narratives is a tool that persuades the masses and shapes society, setting it on a particular trajectory. In an age where environmental facts are often denied or distorted by figures of authority or narratives are shaped by the need for commercial backing and are used to create promises that merit investment (Ritchie 2020) it is imperative to tell stories of present and potential futures that speak to the complexity and multiplicity of natural networks as they come to permeate human habitats. Within architecture we traditionally employ narratives to facilitate critical reflection, methods designers adopt within post-Anthropocene bio-design to create bio-futures that investigate ways of co-existing and that challenge bio-technical utopias.

## 3.0 INCLUSIVE ENVIRONMENTS

The mechanistic view is not a means for relinquishing responsibility; however, it does objectify the living, removing the moral constraints of the pre-Enlightenment era where humanity was believed to be at the mercy of untamed nature. This highlights the necessity to think outside the context of individual units that can be assembled in different ways and to look to the ecologies that we enrich and disrupt. This method of working inevitably requires a continual shifting between scales, something that architects as design practitioners are closely accustomed to doing. In traditional architecture we mediate between scales, whilst designing a detail we inevitably think of how the basic unit would fit into the larger whole of the overall building, the local context and the wider issues of material sourcing and sustainability impact. These ways of thinking across scales and across performative and social issues can be translated into an ethical, egalitarian, bio-design practice of interspecies collaborative creation rather than operating from a capitalist premise of optimized mass production through simplification and uniformity. However, this also requires the acquisition of knowledge outside of the design field to aid the formation of plausible design solutions that take into account organismal needs and limitations as well as the effect upon the wider natural and manmade context in terms of introducing a living participant that may have a wider effect beyond the intended purpose. This applies to both organisms found in nature as well as engineered species, or propagating species through human activity for example the Deepwater Horizon oil spill in 2011 that encouraged the growth of locally found bacteria and algae, with the effects of such population changes on the wider ecology remaining largely unknown (Hird and Clark 2014). This suggest that practices need to be considered regardless of whether organisms are natural or edited in a lab.

In the practices this paper has highlighted, it becomes apparent that nature is continuously changing due to human activity and interaction with the natural environment, whether those practices are ones of husbandry or genetic

manipulation, the natural is becoming increasingly more entangled in emerging design. This places a responsibility with the designer to consider the wider implications of biological futures and to recognize that unlike machines these co-creative species do not function in isolation but are constantly changing and interacting and in Deleuze Guattarian terms, they form assemblages (Zapasnik et al. 2013). In such work it is important to acknowledge that a non-anthropocentric view of nature is not fully possible as design practitioners inevitably engage with human needs and perceptions and are not fully able to engage with such issues from a non-human perspective or to create narratives that do not originate in human terms. However, a better understanding of humanity's dependence on nature can foster greater levels of respect and restraint. The holistic approach does not necessarily exclude synthetic biology, rather it encourages a reframing of objectives when engaging with such practices. It can be argued that the human impact on the planet's ecology has been too profound and that it has set natural systems on a course towards ecological catastrophe. From this point of view the idea of using our scientific knowledge to remedy some of the damaging effects of human activity becomes a viable option. However, the story that we tell in this case shifts from its previous anthropocentric bias that seeks to perpetuate human wellbeing and prioritizes natural health in terms of capital return, to an emphasis on establishing a mutualistic relationship where humanity takes responsibility whilst recognizing that technology is not the panacea for the ecological crisis, but can help rectify some of the problems it has caused in the past by finding new ways to co-exist.

## CONCLUSION

This paper has highlighted the potential issues with technocratic epistemological approaches in relationship to working with living organisms. It presents an alternative bio-design epistemology that redefines living organisms as morally considerable and that builds on scholarly work from the humanities and scientific research that studies ecological networks. The paper postulates a framework for a Post-Anthropocene bio-design practice that identifies thinking about design and language as a primary difference in expression and whilst it does not exclude scientific methods it is recognizing that nature is in a state of perpetual change through, growth, decay and reproduction and that it cannot be maintained within a static state, differentiating it from inanimate matter. The proposed practice encourages a wider conversation and equal prioritization of ecological and human objectives and acknowledges the limitations to our ability to be fully impartial, taking into account the destructive nature of making.

## ACKNOWLEDGEMENTS

This research was funded by Research England as part of the Hub for Biotechnology in the Built Environment.

## REFERENCES

- Armstrong, Rachel. 2015. *Vibrant Architecture: Matter as a Codesigner of Living Structures*. *Vibrant Architecture: Matter as a Codesigner of Living Structures*. 1st ed. Warsaw: De Gruyter Open.
- Arnardottir, Thora, and Jessica Dias. 2020. "Bio-Lum-Sac: Algae as a Bioluminescent Light and a Bio-Textile." *BioBabes*. 2020. <https://www.biobabes.co.uk/bio-lum-sac>.
- Aronowsky, Leah V. 2017. "Of Astronauts and Algae." *Environmental Humanities* 9 (2): 359–77. <https://doi.org/10.1215/22011919-4215343>.
- Bacon, Francis. 2000. *The New Organon*. Cambridge Texts in the History of Philosophy. Cambridge [U.K.]; New York: Cambridge University Press.
- Ben-Gurion University of the Negev. 2016. "Plasticura." IGEM. 2016. [http://2016.igem.org/Team:BGU\\_ISRAEL/Description](http://2016.igem.org/Team:BGU_ISRAEL/Description).
- Benaroyo, Lazare. 1998. "Rudolf Virchow and the Scientific Approach to Medicine." *Endeavour* 22 (3): 114–16. [https://doi.org/10.1016/S0160-9327\(98\)01136-3](https://doi.org/10.1016/S0160-9327(98)01136-3).
- Bensaude-Vincent, Bernadette. 2013. "Between the Possible and the Actual: Philosophical Perspectives on the Design of Synthetic Organisms." *Futures* 48 (April): 23–31. <https://doi.org/10.1016/j.futures.2013.02.006>.
- Bryant, Taimie L. 2009. "Transgenic Bioart, Animals, and the Law." In *Leonardo's Choice*, 123–48. Dordrecht: Springer Netherlands. [https://doi.org/10.1007/978-90-481-2479-4\\_8](https://doi.org/10.1007/978-90-481-2479-4_8).
- Carlson, Robert H. 2011. *Biology Is Technology: The Promise, Peril, and New Business of Engineering Life*. Cambridge: Harvard University Press.
- Catts, Oron, and Ionat Zurr. 2004. "Victemless Leather." *Tissue Culture and Art Project*. 2004. <https://www.tca.uwa.edu.au/vl/vl.html>.
- Chisholm, Hugh, ed. 1911. "Ludwig, Karl Friedrich Wilhelm." In *Encyclopædia Britannica*, 11th ed., 17:114. Cambridge University Press.
- Collet, Carole. 2020. "Designing Our Future Bio-Materiality." *AI & SOCIETY*, September. <https://doi.org/10.1007/s00146-020-01013-y>.
- Cornwall, Warren. 2019. "Researchers Embrace a Radical Idea: Engineering Coral to Cope with Climate Change." *Science*, March. <https://doi.org/10.1126/science.aax4091>.
- Dreyfus, Gabrielle, and Chad Gallinat. 2015. "Rise and Shine: Lighting the World with 10 Billion LED Bulbs ." Department of Energy. December 7, 2015. <https://www.energy.gov/articles/rise-and-shine-lighting-world-10-billion-led-bulbs>.
- Finkelstein, Gabriel. 2013. *Emil Du Bois-Reymond: Neuroscience, Self, and Society in Nineteenth-Century Germany*. *Emil Du Bois-Reymond*. Cambridge: The MIT Press. <https://doi.org/10.7551/mitpress/9543.001.0001>.

- Fletcher, Kate, Louise St. Pierre, and Mathilda Tham, eds. 2019. *Design and Nature: A Partnership*. New York: Routledge. <https://doi.org/10.4324/9781351111515>.
- Guiry, Michael D. 2012. "How Many Species of Algae Are There?" *Journal of Phycology* 48 (5): 1057–63. <https://doi.org/10.1111/j.1529-8817.2012.01222.x>.
- Hallmann, Armin. 2007. "Algal Transgenics and Biotechnology." *Transgenic Plant Journal* 1 (1): 81–98.
- Haraway, Donna Jeanne. 2016. *Staying with the Trouble: Making Kin in the Chthulucene*. Durham: Duke University Press.
- Harding, Stephan, and Lynn Margulis. 2009. "Water Gaia." In *Gaia in Turmoil*, edited by Eileen Crist and H. Bruce Rinker. The MIT Press.
- Helmholtz, Hermann von. 1885. *Popular Lectures on Scientific Subjects*. New York: Appleton.
- Hird, Myra, and Nigel Clark. 2014. "Deep Shit." *O-Zone: A Journal of Object-Oriented Studies*, January, 44–52.
- Jr., William E. Leverette. 1965. "E. L. Youmans' Crusade for Scientific Autonomy and Respectability." *American Quarterly* 17 (1): 12. <https://doi.org/10.2307/2711334>.
- Knight, Tom. 2005. "Idempotent Vector Design for Standard Assembly of Biobricks." Cambridge.
- Langill, Caroline Seck. 2009. "Negotiating the Hybrid: Art, Theory and Genetic Technologies." In *Leonardo's Choice: Genetic Technologies and Animals*. [https://doi.org/10.1007/978-90-481-2479-4\\_6](https://doi.org/10.1007/978-90-481-2479-4_6).
- Loeb, Jacques. 1906. *The Dynamics of Living Matter*. New York: Columbia University Press.
- . 1912. *The Mechanistic Conception of Life*. Chicago: The University of Chicago Press.
- Lorimer, Jamie. 2020. *The Probiotic Planet*. London: University of Minnesota Press. <https://doi.org/10.5749/j.ctv19cw9vg>.
- Lotze, Hermann. 1848. *Allgemeine Pathologie Und Therapie Als Mechanische Naturwissenschaften*. Leipzig: Weidmann'sche buchhandlung. [https://archive.org/details/bub\\_gb\\_WMgEAAAAYAAJ](https://archive.org/details/bub_gb_WMgEAAAAYAAJ).
- Merchant, Carolyn. 1980. *The Death of Nature: Women, Ecology, and the Scientific Revolution*. 1st ed. San Francisco: Harper and Row.
- Ramirez Figueroa, Paola Carolina. 2018. "Bio-Material Probes: Design Engagements with Living Systems." Newcastle upon Tyne: University of Newcastle upon Tyne.
- Ritchie, Stuart. 2020. *Science Fictions: Exposing Fraud, Bias, Negligence and Hype in Science*. London: Bodley Head
- Roosegaard, Dann. 2017. "Glowing Nature." Studio Roosegaard. November 17, 2017. <https://www.studioroosegaard.net/project/glowing-nature>.
- Schwann, Theodor. 1847. *Microscopical Researches into the Accordance in the Structure and Growth of Animals and Plants*. London: Sydenham Society.
- Shiva, Vandana. 2000. *Tomorrow's Biodiversity*. 1st ed. London: Thames & Hudson. <https://catalogue.nla.gov.au/Record/2245892>.
- Stefanova, Assia, Thora H Arnardottir, Dilan Ozkan, and Sunbin Lee. 2019. "Approach to Biologically Made Materials and Advanced Fabrication Practices." In *International Conference on Emerging Technologies In Architectural Design (ICETAD2019)*, edited by M. Asefi and M. Gorgolewski, 193–200. Toronto: Ryerson University.
- Stefanova, Assia, Ben Bridgens, Pichaya In-na, Gary Caldwell, and Rachel Armstrong. 2020. "Architectural Laboratory Practice for the Development of Clay and Ceramic-Based Photosynthetic Biocomposites." *Technology|Architecture + Design* 4 (2): 200–210. <https://doi.org/10.1080/24751448.2020.1804764>.
- Tandon, Nina, and Mitchell Joachim. 2014. *Super Cells: Building with Biology*. Vol. 41. TED Conferences. [https://www.amazon.com/kindle/dp/B001CXN3VA/ref=rdr\\_kindle\\_ext\\_eos\\_detail](https://www.amazon.com/kindle/dp/B001CXN3VA/ref=rdr_kindle_ext_eos_detail).
- Tsing, Anna. 2017. *The Mushroom at the End of the World: On the Possibility of Life in Capitalist Ruins*. Princeton: Princeton University Press.
- Wertheim, Margaret, and Christine Wertheim. 2020. "Crochet Coral Reef." 2020. <https://crochetcoralreef.org/about/theproject/>.
- Woodyatt, Amy. 2020. "Scientists Create Glow-in-the-Dark Plants." CNN. April 27, 2020. <https://edition.cnn.com/2020/04/27/world/glowing-plants-intl-scli-scn/index.html>.
- Zapasnik, Jonathon, Hannah McCann, Miranda Bruce, and Rosanne Kennedy. 2013. "All Those Little Machines: Assemblage as Transformative Theory." *Australian Humanities Review* 55: 45–66.
- Zurr, Ionat, and Oron Catts. 2004. "The Ethical Claims of Bio-Art: Killing The Other Or Self-Cannibalism." *Australian and New Zealand Journal of Art* 5 (1): 167–88. <https://doi.org/10.1080/14434318.2004.11432737>.

# Utterances and Similes: An Exploration of Participation and Linguistics in Architecture

Noémie Despland-Lichtert<sup>1</sup>, Brendan Shea<sup>1</sup>

<sup>1</sup>Texas Tech, Lubbock, Texas

**ABSTRACT:** In 1955, philosopher and linguist John Langshaw Austin coined the concept of "performative utterance," a form of speech that both includes a call for action and a transformation of reality. This type of short speech act both describes and, simultaneously, changes reality through the power of language. Another figure of speech, comparing two different things by explicitly highlighting their similarities, is known as the simile. This paper explores how the concept of performative utterance and simile can be applied to architecture, to comprehend interactive, participatory, and durational "performative spaces." The paper asks: how a space can intrinsically call for its own transformation? How can an environment explicitly respond and transform itself through interaction and participation? What is the meaning of a simile in architecture? What is the role of architectural curation? In this paper, we investigate performative projects—those calling for action and triggering their own transformation through users' participation—by examining a series of interactive, transformative, and durational spaces and curatorial projects. Ultimately, we argue that the ephemeral and interactive nature of performative spaces serves to transfer agency from architects and curators to audiences—including new spectators, users, participants, and activators—therefore creating an expanded cultural dialogue and critical discourse for the discipline of architecture.

**KEYWORDS:** Utterance. Simile. Transformation. Participation. Performance.

"Once we realize that what we have to study is not the sentence but the issuing of an utterance in a speech situation, there can hardly be any longer a possibility of not seeing that stating is performing an act."

(J. L. Austin 1962 p.139)

## 1. INTRODUCTION: ARTICULATING ARCHITECTURE\*

This paper proposes borrowing concepts from the field of linguistics to apply to architectural analysis. While psychoanalyst Jacques Lacan defines speech as an active and often uncontrollable mode of communication, architecture is often referred to as a language, or a set of languages, intended to systematically define, describe, measure, and order. Perhaps in part because of distinctions like these, linguistics doesn't appear to always play a well-articulated role in the discipline or practice of architecture, though we might build a bridge between these fields by relying on a more general definition of language as a form of communication based on shared conventions and meaning. Similar to spoken languages, architecture is based on conventions—ranging from the cultural to the material to the representational. Consider how Robin Evan's definition of architecture points specifically at the gap between two languages; drawing and building. (Evans 1997) The translation between the two, he argues, relies on acknowledging that while a great deal of architecture may be interpreted to be language-like, the circumstances of architectural production are a direct result of critical and creative engagement with medium-specific conventions. At the design scale, a set of drawing conventions organize the representation of the design. At a built scale, architecture organizes climate, environment, circulation, and the behaviors of those who inhabit it. Specific systems of measure—consider metric and imperial systems—organize the conception, depiction, as well as construction of the environments we inhabit. In Canada, architecture schools teach design in metric, and construction/timber is done in imperial which offers a myriad of possibilities for "lost and found" in translation between the two systems. For example, it's not uncommon in Canada to hear designers uttering, "this wall needs to be 12m wide and 5ft tall."

The affinities between language and architecture as organization systems based on conventions prove useful for the consideration of performativity. A few canonical examples from linguistics will serve to illustrate the foundations. "Stating," the linguist J.L. Austin writes in *How to Do Things with Words*, "is performing an act." (J. L. Austin 1962 p.139) Critical theorist Homi K. Bhabha frames culture—including languages, dialect, and slang—as performative. (Bhabha 1994) Judith Butler proposes that gender is performative. Butler's work deconstructs preconceptions of gender as binary, natural, or *given*. Gender, she argues, instead is a social construct, performed along a spectrum. (Butler 1988) Taking inspiration from the post-structuralist approaches of Bhabha and Butler, this paper critiques the dominant mode of understanding architecture as either building or discourse. It situates a genealogy of projects to argue that architecture's meaning is socially constructed, oftentimes performing, enacting, or embodying both spatial and cultural roles simultaneously. Specifically, the research examines the concept of the "performative utterance" as well as the "simile" and explores contemporary practices in the design and curation of architecture, arguing in each case that the

ephemeral and interactive nature of performative spaces serves to transfer agency from architects to audiences. The paper first offers a brief definition of both concepts, then discusses their application in relation to a series of built projects, and finally uses both concepts to analyze contemporary curatorial trends.

## 2. DEFINITIONS - ALTERNATIVE WAYS OF ARTICULATING ARCHITECTURE

The concept of "performative utterance" first coined by philosopher and linguist John Langshaw Austin is a form of speech that both includes a call for action and a transformation of reality. (J. L. Austin 2020) When it comes to architecture, museum architecture is a good example of performative space, as the appearance of the building modifies the way the visitors behave. (Duncan 1995) Upon entry, one knows they must move at a slower pace and speak in a lower voice. The architecture conveys a clear message that includes a call for action and transformation of reality. This paper focuses on designs that rely on participation to function as performative utterance, shifting the agency from the architect to the audience. On the other hand, the simile is an action of speech comparing two different things by explicitly highlighting their similarities - something is *like* something else, or something is *as* something else. In contrast to the use of metaphors, the use of the simile makes the process of comparison explicit through the use of the word "like" and "as". Therefore, similes often rely on adjectives and are as figurative as metaphors, while also more direct. For example, something is as tall as something else or is large like something else. The term simile has been used since the 15th century although the use of similes in language precedes their naming. The notion of the simile can also be applied to architecture, in select cases—not when architecture looks like something else (metaphor), but instead performs like something else, in response to a spatial, durational, or programmatic situation.

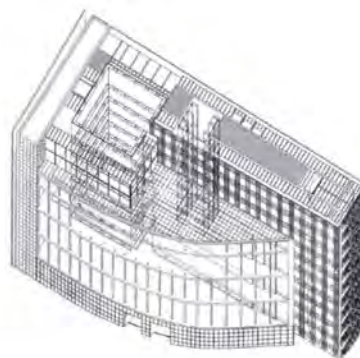
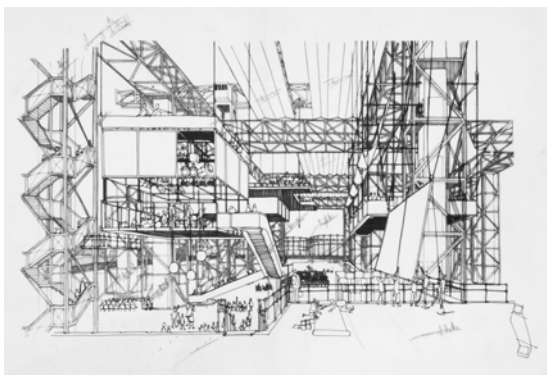
## 3. BUILDINGS/DESIGN WORK

### 3.1 Building Utterance - Situating Building / Building Situations

Arguably, all types of architecture, to a certain extent can be considered performative, describing, and transforming the world that surrounds them. Since the second half of the 1970s, sociologists and philosophers have analyzed spaces, their production, and the daily practices of their users, shifting the agency from the figure of the architect toward the relationship between the built environment and those who inhabit it. (De Certeau:1980, Lefebvre: 1974) Writing architectural history can encompass more than biographical research of the designers, expanding scholarship to include how buildings and urban fabric shape the behavior and experiences of users. Similarly, one can argue that all buildings are durational, as they do not exist in a controlled environment but are subject to seasons, time of the day, and fluctuating usage. However beyond agreed-upon notions of spatial agency, in this portion of the paper, we would like to focus on interactive spaces that explicitly call for and perform their transformation through user participation. We will explore examples of building as a system, using technology (high and low), to perform their transformation.

#### 3.1.1 Fun Palace: Frameworks, Play, and Provisioning for Programmatic Flux

Conceived as a flexible framework, Cedric Price's Fun Palace was meant to function as a system or a spatial infrastructure that was endlessly adaptable. (Figure 01) "Choose what you want to do," the architect uttered in his original blueprints alongside collaborator and co-creator, the theater director Joan Littlewood, "...or watch someone else doing it. Learn how to handle tools, paint, babies, machinery, or just listen to your favourite tune. Dance, talk, or be lifted up to where you can see how other people make things work." (Price and Littlewood 1964) Inspired by cybernetics, the structure would allow different plug-ins to be added or taken away as necessary to complement and enhance the capacity of the architectural system to adapt to the shifting programmatic needs and spatial desires of the users. Although the Fun Palace never saw built completion, the transformable and modular project has been highly influential in terms of the use of systems and participation in architecture. The building by nature demands to be interacted with and transformed. Price's design, similarly to a performative utterance, describes, calls for action, and transforms its reality.



**Figure 1:** Perspective drawing of Fun Palace from the promotional brochure by Cedric Price and Joan Littlewood, 1964. (Cedric Price Fonds, CCA).

**Figure 2:** Axonometric drawing of the Arab World Institute (Jean Nouvel, 1981).

### 3.1.2 Arab World Institute - Moucharabiehs, Motors, and Mechanising the Exterior Envelope

The Arab World Institute in Paris, designed by the office of the architect Jean Nouvel, is known for its dichotomies; a hinge between European and Arabic cultures, a link between hi-tech formalism and vernacular symbolism, and a juncture between the exterior environment and the regulated interior. (Figure 02) The south-facing envelope is composed of several panels of metallic laces on glass facades. Each panel is composed of 240 photo-sensitive motor-controlled apertures or shutters. The building kinetic envelope borrows both the abstract qualities and shading properties of the moucharabiehs - carved latticework windows typical of Islamic architecture. However beyond symbolism, these kinetic “brise soleil” provides a relatively constant amount of light inside the galleries. Each unit is connected to light sensors and opens and closes responding to the outside condition to let natural light in the building. Here again, this design feature is in constant transformation, responding to and changing reality. The building takes an active role in shaping the relationship between exterior and interior. Environmental regulation comes from the building itself. Similar to the functioning of a performance utterance, the building both enunciates and transforms.

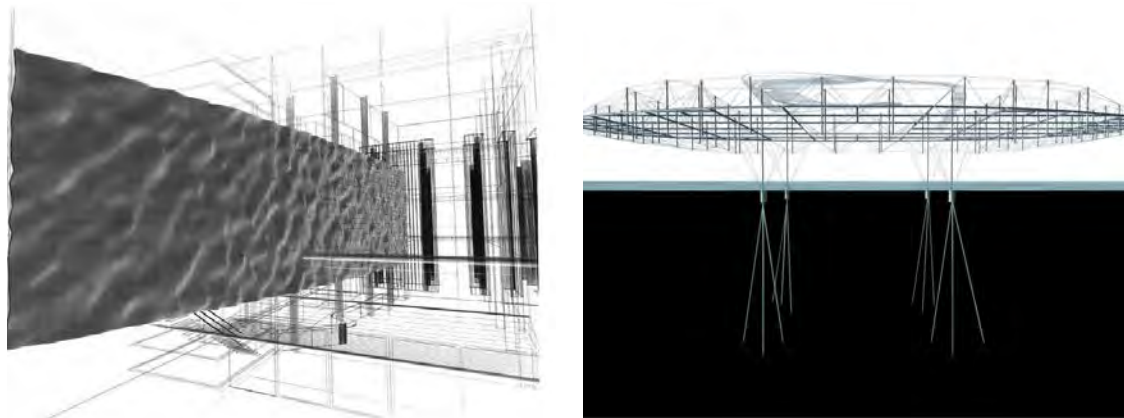
### 3.1.3 HypoSurface - Assessing, Automating, and Animating Architecture’s Interior Surfaces

HypoSurface conceived by dECOI architects is a kinetic wall, pushing forward and retracting, activated by sensors and a hidden pneumatic system. (Figure 03) The goal of the project was to use parametric design to create an environment that would respond to its surroundings, being capable of capturing and responding to sound, movement, weather, and electronic input. Passerbys would trigger the sensors and see the wall respond to their movement, they would understand the consequence of their actions, and start interacting with the wall. Similarly to a performative utterance, the wall would call for human action and transform the physical reality by constantly changing forms.

In these examples, the notion of performative utterance allows the interpretation of the building as a partly autonomous system that requires additional participation and interaction to reach full performative impact.

## 3.2 Building Similes

The use of simile in architecture might first evoke ideas of simulacrum or metaphoric architecture but this paper focuses on simile beyond symbolism. Instead of addressing what architecture looks like, this section considers how it feels like and performs, exploring temporal environments that convey multi-sensorial experiences.



**Figure 4:** Perspective drawing of the HypoSurface (deCoi, 2011).

**Figure 5:** Section perspective of the Blur Pavilion (Diller Scofidio Renfro, 2002).

### 3.2.1 Blur - Appearance, Experience, and Subverting Environmental Mimesis

The Blur Building was a temporary structure on the Lac Neuchâtel in Switzerland, made of steel and vapor from the lake’s water. (Figure 05) Conceived as an architecture of atmosphere by Diller Scofidio Renfro for the Swiss Expo in 2002, the building appeared from afar as a low cloud just above the lake. As one would come closer upon approach, the steel structure would slowly reveal itself from underneath the fog. The cloud could then be entered and navigated - given you were equipped with a raincoat at the entry - but would disappear as it is penetrated. The nature, appearance, and experience of the “building” were completely different from afar and from up close, transforming, disappearing, and revealing itself under the viewer’s eyes. The building colloquially referred to as “Le Nuage” gets its nickname from the fact that it felt like entering a cloud. “Contrary to immersive environments that strive for visual fidelity in high-definition with ever-greater technical virtuosity,” state the architects, “Blur is decidedly low-definition.... Upon entering Blur, visual and acoustic references are erased. There is only an optical “white-out” and the “white-noise” of pulsing nozzles.” (“Blur Building” 2002) Beyond appearance and symbolism, the building deconstructed the simplistic “cotton ball” conception of cloud and offered a haptic experience of the mass of water vapor.



### 3.2.2 Your Rainbow Panorama - Promenades, Perceptions, and Producing Immersive Contingencies

Your Rainbow Panorama offers another example of an immersive building-scale project functioning as a simile. The collaboration between artist Olafur Eliasson and architect Schmidt Hammer Lassen is a circular walkway made of tinted glass. The installation proposes colorful views of Aarhus's cityscape and offers a fully immersive yet outward gazing experience. Each portion of the walkway is made of a different color and the complete rainbow is never visible at once (except from a sky view). The full rainbow is only experienced through walking the full promenade. This project again relies on the durational interaction between the visitors and the building. In these examples, the buildings do not simply look like something else but feel like an environment, bringing haptic sensation and durational experiences beyond symbolism. The similes share certain qualities and aspects of the phenomenon they refer to, they convey multi-sensorial experiences.

### 4. Curatorial Utterances and Similes

In addition to design projects, the use of the linguistic concepts of performative utterance and simile appears to be particularly relevant to the analysis of curatorial projects. Architecture is always by nature on display - and yet the architecture exhibition most often does not display buildings. Architecture curating exhibits peripheral objects, documents, drawings, photography, models. One can argue that the object of study itself, architecture and the building, is simply never on display in the exhibition. The types of media that architecture curating relies on are meant to convey information and impressions of a building that often remains absent from the show. Therefore the use of simile becomes more relevant, the model has the formal qualities of the building, the drawing is as intricate as the built form, etc. Although architecture as a cultural production is not limited to the built environment, this initial paradox of the architecture curating is relevant to consider the idea of simile.

Similarly, performative utterance, as something that both describes and transforms a situation, seems particularly relevant to consider in relation to the practice of architectural curation. The role of the curator often is to observe a phenomenon, define and name it and, by so doing, to reinforce the concept's timeliness, relevance, and efficacy for shaping the contours of contemporary discourse. Consider for example the 1932 MOMA "International" show, an exhibition that both noticed the rise of a phenomenon, named a movement and "constructed" the International Style movement as Architectural History now recalls it. Curators by gathering, putting on display, and theorizing make sense of phenomenon and create names for them. Exhibitions draw connections and make history, naming and transforming the discipline and practice of architecture in the way of a performative utterance.

### 4.2 Curatorial Utterance

Curatorial projects that function as performative utterances call for the visitor's participation to activate of the work on display. The curatorial approach observes and names a reality as well as transforms it simultaneously.

#### 4.2.1 Refresh - Clicks, Cams, and Complying in a Network of Surveillance

Refresh was an exhibition by Diller Scofidio Renfro at the DIA center for the arts from 1998. The exhibition presented the live footage of 12 cameras placed in offices around the world. (Figure 06) The title itself is a form of performative utterance "refresh", such as a refresh of the feed. In the exhibition, the visitor could select from specific feeds, pause them, fast forward, or move backward in time to create their own narrative. In this process, the viewer becomes both a voyeur and the actor of a "choose your own adventure" story. Beyond the banal aspect of each feed, the narrative and meaning of the exhibition are created by the polyphony of the different webcams and the different approach each visitor chooses to take. However, beyond the participatory interactive aspect of the show, the surveillance webcam in and of themselves exercise power on the staff of the offices they are shooting. Being watched shapes the behavior and interaction of the office staff in a Foucauldian dynamic. The 12 cameras themselves function as performative utterances as they both document and transform the situation.



**Figure 6:** Screen Capture from the Refresh Exhibition (DIA, 1998)

**Figure 7:** Photograph of CLUI Bus Tour from *Overlook* (CLUI, 2006)

#### 4.2.2 Overlook -Tickets, Timetables, and Touring Interpretive Terrains Together

Overlook: Exploring the Internal Fringes of America was a series of guided bus tours organized by the Center for Land Use Interpretation - a Los Angeles-based nonprofit exhibition space and research organization dedicated to examining contemporary landscape issues across the United States. Each tour and the subsequent book explores strangely unfamiliar lands of the United States. (Coolidge, Simons, and CLUI 2006 ) (Figure 07) The title of the exhibition plays on the ambiguity of the word overlook. As a verb, overlook means failing to notice, and as a noun, it means “a place from which one may look down on a scene below.” Playing on this turn of phrase, the series of guided tours transformed the underseen locations into viewing points by bringing the public to them, transforming sites of disregard into landscapes of reflection, and ultimately into objects in the publication or on display. The project is an example of a curatorial approach that changes the nature of the object by looking at it. In this case, “Overlook” transforms the disregarded land into objects of study.

#### 4.2.3 The Kid Gets Out of the Picture - Fraternizing, Framing, and Picturing Pavilions Together

“The Kid Gets Out Of The Picture” is a curated collection of installations presented at Materials and Applications in Los Angeles and the GSD in 2016. (Figure 08) Curated by Los Angeles Design Group, the project was a collaboration between LADG, First Office, Laurel Broughton/Andrew Kovacs, and Hirsuta. The title itself is a form of performative utterance, both an observation and a command. Carefully arranged, each installation frames views to the other ones, without prescribing a specific path. The collection of works become activated by the movement and chosen paths of the visitors, as the installations take turns at concealing, revealing, and reframing one another. In this deconstructed promenade, the landscape of parts creates meaning as it transforms itself and its surroundings under the visitors’ eyes.

In this collection of three examples, Refresh, Overlook, and The Kid Gets Out Of The Picture, the performative utterance is the curatorial approach, both describing a phenomenon and transforming the exhibition through participation.

#### 4.3 Curatorial Simile

As previously mentioned architectural exhibition always relies on simile to a certain extent. Exhibitions present a variety of media that resemble, evoke, and complement the built work that most often is not on display. However, the chosen examples of this section, include exhibitions and projects that rely on simile beyond symbolism and reveal phenomena that are left unnoticed.



**Figure 8:** Photograph of The Kids Gets Out Of The Picture (M&A, 2016).

**Figure 9:** Photograph of PHANTOM: Mies As Rendered Society (Office for Political Innovation, 2012).

#### 4.3.1 Phantom: Mies As Rendered Society - Rendering, Repairs and Reading Modernism as Myth

“Phantom: Mies as Rendered Society” is an intervention at the Barcelona Pavilion by the Office for Political Innovation. (Figure 09) For the exhibition, the concealed content of the maintenance basement (included in the 1986 reconstruction of the infamous Barcelona Pavilion project) was brought out of the shadows and into public view. The previously hidden cleaning supplies and machines were relocated and put on display in pristine interiors of the Barcelona pavilion. The title of the exhibition uses a simile to describe that the building functions like society, that Mies’s design conceals, if not erases, domestic labor. This simple intervention lifts the veil off the care and maintenance that the building requires and the staff that attends to it. The objects on display shed on light the social and daily reality of the inner functioning of the building. Here this unveiling is a performance that contests the erasure of janitorial staff contribution. More broadly Phantom critiques the erasure of labor and plurality of contributions from the modernism narrative focusing on the single mind creative genius and points to the highly mediated experience that is the one of visiting famous buildings.

#### 4.3.2 Nuit Blanche - Media, Meditation, and Reading the City As a Museum

A more diffuse set of events, Nuit Blanche, is a city-wide festival during which museums and other art institutions open their door to the public at night. In these events the night becomes like the day, the exhibitions are open overnight as they would be during normal hours. Nonetheless, the general ambiance of these events is also different from typical daytime museum visits. The meditative qualities of a traditional museum visit are swapped for more social and festive experiences. This curatorial shift changed the possibility of experiences. The shift highlights that our experience with collections is highly curated by standards of times, locations, and ways to interact with the work. The series of opening sheds light on the highly mediated experience that a museum visit is.

These two examples, despite adopting completely different approaches, still function similarly to reveal hidden assumptions and to complexify the straightforward modernist narratives by shedding light on how highly mediated our relationships to exhibits are.

### 5. Conclusion

Despite being at an early stage of this research, we believe that the use of linguistics offers several promising avenues for the study of architecture and curatorial practices. Similes appear to produce ephemeral and experiential projects and performative utterances function as machines and systems. Architectural utterances, as we define them, trigger user participation and promote active interaction. Architectural similes convey feelings and haptic experiences beyond visual symbolism, they work to unveil systems and deconstruct preconceptions. In both utterances and simile, design and curatorial practice rely heavily on participation. Through the lens of participation, these concepts offer frameworks and a new set of terminology to explore design projects, exhibitions, and environments.

The paper argues that the ephemeral and interactive nature of performative spaces serves to transfer agency from architects to audiences, including new spectators, inclusive participants, and activators, therefore creating an expanded cultural dialogue and critical discourse for the discipline of architecture. These observations leave us wondering what other linguistic concepts can prove useful for the analysis of architecture? How does redefining participation and authorship work to situate architecture curating within the discipline? In this initial phase of research, understanding spaces as performative seeks to deconstruct binaries between building and discourse, as well as between designers and users. A less binary approach to understanding architectural participation, relying instead on a concept of a spectrum of performativity, explores the potentials for diversifying participation and expanding possibilities for engagement and authorship.

### BIBLIOGRAPHY

- Amelia Jones. 2013. *Seeing Differently: A History and Theory of Identification and the Visual Arts*. Taylor and Francis. <https://doi.org/10.4324/9780203146811>.
- Bhabha, Homi K. 1994. *The Location of Culture*. Routledge.
- Cedric Price and Joan Littlewood. 1964. "Fun Palace Promotional Brochure." Canadian Center for Architecture.
- Coolidge, Matthew, Sarah Simons, and Center for Land Use Interpretation. 2006. *Overlook: Exploring the Internal Fringes of America with the Center for Land Use Interpretation*. New York: Metropolis.
- Diller Scofidio Renfro. 2002. "Blur Building." DS+R. 2002. <https://dsrny.com/project/blur-building>.
- Duncan, Carol. 1995. *Civilizing Rituals*. London and New York: Routledge.
- Evans, Robin. 1997. *Robin Evans: Translation from Drawing to Building and Other Essays*. London: Architectural Association.
- J. L. Austin. 2020. *How To Do Things With Words*. S.I.: Barakaldo Books. <http://public.eblib.com/choice/PublicFullRecord.aspx?p=6235257>.
- Judith Butler. 1988. "Performative Acts and Gender Constitution: An Essay in Phenomenology and Feminist Theory." *Theatre Journal (Washington, D.C.)* 40 (4): 519–31. <https://doi.org/10.2307/3207893>.
- Studio Olafur Eliasson. 2011. "Your Rainbow Panorama - Press Release." <https://www.archdaily.com/469611/your-rainbow-panorama-olafur-eliasson>.

# New Reality. New Architecture.

Salah Imam<sup>1</sup>, Brian R. Sinclair<sup>2</sup>

<sup>1</sup>University of Calgary + Entuitive Consulting Engineers, Canada

<sup>2</sup>University of Calgary + sinclairstudio inc., Canada

**ABSTRACT:** The last few decades can be characterized, socially and physically, by rapid shifts and intense impacts. Climate changes year after year, as does advanced technology and human behaviour. Environmental catastrophes and infectious outbreaks force the re-forming of entire cities and regions, imposing high human and economic costs. The built environment cannot keep up with these deviations—rather it simply, in best case scenarios, endeavour to limit damages. Through our ongoing research into *flexible* architecture, particularly in residential projects, the most common perceptions have expensive a negative connotation. For many industry professionals, flexible design has been branded as costly, difficult to deploy, and demanding state-of-the-art gadgetry. Such views have been driven, in part, by technical attempts to future-proof buildings through the application of specific parameters such as movable partitions or pursuing over-engineering.

*Why then, after more than a century of attempts to design for flexibility, the issue is still marginalized to the profession at large?* Through reviewing of the existing literature, it became clear that design approaches have focused primarily on physical flexibility (e.g., floor-to-ceiling height, structural load, organization of space, etc.). This overly narrow approach arguably leaves the user and the environment out of the equation, leading to inevitable failure of the built-environment's capacity to respond to *social or environmental* changes. The present research argues that achieving flexible buildings demands a more balanced and integrated approach, namely the pursuit and realization of *Agile Architecture*. A re-conceptualization is needed that goes beyond matters of physical durability to more nuanced views of buildings as socialized products constantly in the making and always responding to a milieu of change. The present research contextualizes the unifying principles of Agile design by underlining the industry mindset (via a *survey to illuminate barriers against formulating/implementing such a holistic approach*) and studying current residential design practices (via *seminal cases of projects strategically drawn from global cities, illustrating progressive concepts within the design, legislative and/or financial ethos*). The present paper positions Agile Architecture in the context of *environmental, social and economic sustainability*, then delineates progress along a multifaceted journey that aspires to dramatically reconsider the way we design buildings.

**KEYWORDS:** agility, sustainability, flexibility, systems, holism, design, change, innovation

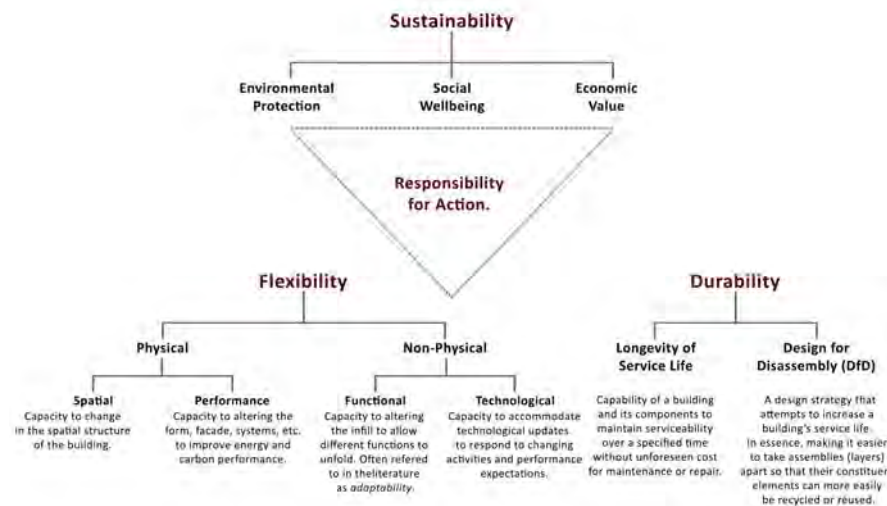
## INTRODUCTION

*"The swift global response to COVID-19 proves that our societies are, in fact, Agile, dynamic and resilient. It shows that we have the capacity to embrace and resolve different levels of challenges if we want to. The world is at an inflection point. We have the chance to reset our globalized systems in a way that mitigates climate change, welcoming a new sustainability era."* (Imam, 2020)

The speed and means of the coronavirus crisis have taken the world by surprise. The unprecedented actions taken to cope with the virus could not but make us wonder about another global crisis looming on the horizon—climate change. Although both Climate Change and COVID-19 are rooted in the same draining economic behaviour (humans' highly industrialized systems harvest the natural resources of the planet to produce by-products and a huge amount of waste, exhausting the natural ability of the environment to balance itself) and both are deadly and disruptive (Kock et al., 2019), governments have seen them as separate phenomena. They have therefore responded somewhat differently to them (Imam, 2020). In this emerging new reality, coronavirus has much to teach us about how societies should deal with global crises. Indeed, the preservation of a community depends upon its ability to withstand storms that challenge its survival. Today, in addition to worldwide epidemic outbreaks, many parts of the world are increasingly experiencing weather events of an intense nature (Buis, 2019; Irfan, 2019). Societies need to be prepared, not only physically, but with a psychologically and economically positive environment to garner more Agility and enable their continued existence. We need to take the opportunity to holistically look for and investigate ways to preserve communities in the face of social, technological and climate change; and hence the significance of this ongoing research.

Literature reveals that sustainable buildings must have the ability to adjust to changing circumstances and technologies without excessive waste and conflict (Yates, 2003; Kendall and Ando, 2005). The authors (see Imam and Sinclair 2018 + 2020) have previously explored the facets of *flexibility* and *durability* in architecture, as well as exposed the industry's overly narrow focus on operational energy reduction as the main drive to the sustainability agenda. The term *flexible*

has a very broad definition in architecture literature, in part to allow the inclusion of a range of strategies that provides adaptability in response to a particular change or need. In one definition, flexible buildings are “designed to respond easily to change throughout their lifetime” (Kronenburg, 2007, p. 6), and in another it is a building “that can adjust to changing needs and patterns, both social and technological” (Till and Schneider, 2007, P. 4). Both definitions suggest that flexible buildings are designed with the ability to meet changes that will happen over time. The definition of *change* is also very broad as it can include social, cultural, economic and technical changes that can impact how—in the context of the present research—housing would remain relevant. Within this context, the present research explores formulating a new paradigm for design that is more independent and responsive; that integrates aspects of durability, flexibility and sustainability; that introduces all layers of physical, social, environmental and financial factors in the form of continuously evolving and dynamic framework, better interlacing design phases to construction, operation, occupancy, disassembly and reuse; a paradigm that we define as “Agile”. The present paper introduces *environmental, social and economic* facets as an essential core to qualitatively define Agile Architecture. Figure 1 distinctively outlines how the present research places flexibility and adaptability in the realm of responding to change, as well as summarizes the authors’ perception towards Agile design constructs.



**Figure 1.** The authors’ interpretation towards Agile design constructs. The interrelation between all categories enhances a building’s ability to respond to different functions, patterns of use, technological relevance and energy/carbon reduction. In the context of the present paper, Responsibility refers to invoking ethical obligation to balance aspects of durability and flexibility—while introducing environmental, social and economic factors via a framework for dynamic design.

frameworks such as the one proposed by Carole Collet, that identifies a hierarchy of bio-design practices; nature as a model, nature as co-worker and nature as a ‘hackable’ system. Collet goes on to define two distinctly different types of designers, the ‘designer cultivator’ and the ‘designer biologist’ (Collet 2020). In this paper we are going to look at the different premise of such bio-design practices, interrogating the range of intentions underlying different types of making in relationship to their historical and cultural origins. The paper identifies a framework for post-Anthropocene bio-design practice that defines a way for reframing our interaction with the natural world in the context of working and co-habiting with living microorganisms.

## 1.0 BACKGROUND

The idea of applying a singular design solution to housing leaves not only a disheartening image of the approach to residential design, but also a lack of personal choice and flexibility in living arrangements (Marcus, 2006). Advancing from the Open Building approach (OB), a concept that looks at creating adaptable spaces that change with the user (Habraken, 1972; Nascimento, 2012), and Brand’s layers of flexibility, the idea that buildings can be sectioned into distinct levels for decision making (Brand, 1995), might be the seamless means by which to redefine how designers think about residential design in the 21<sup>st</sup> century. We don’t know what the world will be like in the future—who can predict social change, technological change or climate change? There’s a significant risk that today’s well-intentioned design decisions will turn out badly. Flexible designs intend to respond to events, even when they unfold in unpredictable ways, creating environments centered around the user as the decision-making agent. It’s an excellent principle, but no design could be so flexible as to cope with every possible contingency (Fawcett, 2011). In order to endure a building for a prolonged period, the structure needs support from more than just the environment. In other words, architecture must be functionally, economically and technologically relevant and evolved.

Through reviewing of the existing literature, it became clear that design approaches have focused primarily on *physical* flexibility. For context, the following design parameters are repeatedly cited by notable scholars over the last two decades: *Floor-to-ceiling height, structural load, space area/volume for systems zone, floor plan, vertical circulation,*

*HVAC system and distribution, interchangeable plug components, organization of space, separation of functions, plan depth, external façade and cladding design, systems physical access, core design and partial/phased demolition.* (Gann and Barlow, 1996; Ratcliffe and Stubbs, 1996; Keymer, 2000; Heath, 2001; Larssen and Bjorbery, 2004; Arge, 2005; Richter and Laubach, 2005; Verweij and Poelman, 2006; 3DReid, 2006; Gijbers et al., 2009; Rawlinson and Harrison, 2009; Wilkinson, 2014). This overly narrow approach arguably leaves the user and the environment out of the equation, leading to inevitable failure of the built-environment's capacity to respond to *social* or *environmental* changes. Meaningful sustainability resides at the nexus of these two aspects. The authors envision the theoretical exploration of a new paradigm for design as a medium to aid designers, developers and policymakers—and by implication incorporated in the decision-making process—in applying and realizing greater project Agility. The present paper introduces both the survey and case studies data as subject for the next—data and in-situ analyses—phase of the study. Survey explorations (*the online questionnaire collected 104 responses illuminating contextual barriers against formulating/implementing such an innovative approach*) + residential case studies data (*via eight seminal cases of projects strategically drawn from global cities with the highest current and projected floor areas in the 21<sup>st</sup> century, illustrating progressive concepts within the design, legislative and/or financial ethos*), in tandem with the strategic literature review, aim to highlight leading themes, ideas and practices of Agile architecture. The next stage of the research synthesizes and delineates a progressive framework for Agility—equipping architects with the theory and techniques needed to realize more responsive and responsible buildings.

## 2.0 RE-ESTABLISHING SUSTAINABILITY

The triple bottom line of sustainable development: *environmental protection, social equality and economic growth*—put forward by The Brundtland Report: *Our Common Future*—helped to conceptualize sustainability as a balance of competing frames. As a significant challenge to the Brundtland model of sustainability, McDaniel and Lanham (2010) view sustainable development “not as a goal that can be reached through the achievement of balance but as a dynamic process of continuous evaluation, action and re-evaluation.” Indeed, the pursuit of sustainability is akin to an Agile system that holistically accounts for environmental, social and economic sustainability.

### 2.1 Agility and environmental sustainability

Ideally, flexible buildings are designed with envelope, structural and systems durability, as well as layout (infill) adaptability. This provides through-life responsive possibilities to users, making conversion processes much easier and, in most cases, cheaper than the major refurbishments or renewals. Consequently, bypassing wasteful processes of demolition and major refurbishments improves the environmental benefits (e.g., embodied carbon, landfill waste). Admittedly, the attention on low operation and embodied carbon contents of buildings are greatly supported by near and long-term legislation agendas, particularly in the developed world (Manewa et al., 2016). Although the variety of low-carbon features associated with flexible buildings tick the boxes for *green* credentials, the market recognition of these buildings has been slow at best, downright obstructionist at worst. It's undeniable that reducing carbon emissions from operational energy use is significantly important and should be a key priority. In fact, in a race to zero emissions, building operations is still the biggest part (approximately *two-third*) of the lifetime carbon equation (UN and IEA, 2018). However, decades of single-minded focus on operational energy efficiency raises the question: *What about the greenhouse gases emitted during the construction of new buildings?* GHG emissions due to material manufacturing, use and disposal are more significant than we realize (Pak, 2019). These emissions are a big *upfront* GHG pulse in the life of a building, which makes them a near-term target for climate change mitigation.

The easiest way to reduce embodied carbon is to consume fewer resources. That can mean less new construction, smaller new construction, fewer materials in new construction, and less frequent material replacements. Existing buildings represent embodied carbon already in the atmosphere. Choosing to keep buildings in service for as long as possible helps amortize that carbon debt by avoiding the new emissions that would be caused by demolition and replacement. Though, the question is: *How can we—as an industry—create longer-lasting buildings by designing for Agility?* The authors realize that there are no silver bullets to answer such a multifaceted question. Looking for prescriptive answers is oversimplifying the problem and risking an unintentionally inefficient result. The life cycle of a building project starts before any physical construction activities and ends after its usable life. At the environmental performance level, life cycle inventory analysis (LCI) can be complex and may involve a dozen individual unit processes in a supply chain (e.g., the extraction of raw resources, various primary and secondary production processes, transportation, among others). In a period of considerable changes in materials manufacturing processes, more rigorous LCA methods—and transparent data collection campaigns—are essential to our common vision goal towards heightened sustainability (figure 2) —*after all, we can't improve what we can't measure*. Reducing embodied carbon—and *keeping buildings around longer*—which is fundamental to the forthcoming frame, requires a holistic iterative process and balancing of trade-offs. Fundamentally, decisions about how to design, what to build, how big to build, and even whether to build at all have a significant impact on the environmental sustainability of the built environment.

### 2.2 Agility and social sustainability

Social sustainability determines the quality and comfort of people and their relationship to their environment. If a building does not fit for purpose, it will remain vacant until it finds the right use. This, arguably, can be an attractive target for crime-related activities as well as creating high repair and maintenance costs to the owners. As a result, this will



negatively impact the social security and wellbeing of said neighbourhood. Therefore, designing for Agility provides win-win solutions to both its stakeholders and society. On the other hand, a building that is unfit for purpose leads to being redundant in its functional tenure (Fiume and Albatici, 2018). The future-proofing endeavour seems difficult and risky because the decisions taken today need to be justifiable tomorrow. In the residential context, with population growth comes the need for more homes. The present research argues that the concept of traditional western houses and buildings, which has been characterizing the human living for centuries, is becoming less common, or even obsolete. In this new reality of infectious epidemics, as well as economic and political instability, moving is not always voluntary, and it is demonstrated by the constant migratory flow of entire populations to places where life expectancy is higher. Populations in large cities worldwide are becoming more diverse and complex, not only through changing household types but through generational and personal lifestyle differences. Over the past few decades, the number of non-traditional household formations grew (i.e., fewer occupants per household) (Hayden, 2002, p. 59). Current residential development practices encourage inflexible design of buildings; in other words, static designs that only support specific stage or lifestyle (e.g., retirement homes). Such design thinking cannot adapt to changes in the community demographics, which in turn causes buildings' own life-span to be shortened when they are forced to be demolished in order to create developments that meet the needs of the population driving the housing demand.

The homes built during the last few decades have generally ignored the growing number of demographics with alternative needs and lifestyles and created a challenging market for these groups to find a suitable home. In the light of such data, the Urban Land Institute (ULI) identified demographic waves that challenge the ideas of traditional life cycle pattern and will require the housing market to provide adaptive solutions to meet their changing needs. Of these demographic groups, the latest Housing Report (2019) by Harvard University expects that over the next decade, two generations will dominate population growth—the millennials (born 1985–2004), and the baby boomers (born 1946–1964) (Fernald, 2019). The baby boomer generation, about 78 million people in the US alone, are diverging from the traditional retirement cycle. A 2018 survey by the Real Estate Advisory (RCLCO) found that 75% of retiring boomers wanted to have an urban lifestyle, rather than going to traditional retirement communities, which in turn is increasing the percentage of vacant dwellings in rural areas. Furthermore, we are already experiencing the outcomes of a global recession, this will likely have a large financial impact specifically on Millennials and Gen Z (born between 1995–2012). The housing challenge for these demographics is the financial constraint (due to large education loan debts, lower-income level and fewer jobs available) that prevents them from living in the urban cores that they desire. The pace of foreign immigration is also critical. Ethnic diversity will only increase, bringing in a mix of cultural values, that perhaps do not fit into the traditional western household model. The cultural difference could be seen on a variety of scales, such as how a room is used or who occupies the household (e.g., multi-generational household). These demographic profiles demonstrate how a population is constantly changing through each generation and how their needs and challenges can vary. Yet, the global architectural response to such changing demographics has been slow at best; ignorant at worst, increasing levels of buildings' functional obsolescence. (OECD, 2019)

### 2.3 Agility and economic sustainability

Culturally, we seem to be somewhat averse to capital spending (one-off spending on high-performance systems or durable infrastructure) —even if not making the investment translates into poorer performance and higher ongoing costs. Flexible designs are more capable of accommodating future changes, and hence reduce the whole life cycle cost, especially when it comes to its in-use phase (maintenance and operations). In some instances, the initial cost may be high when compared with traditional maladaptive buildings, as the flexible design approach intertwines with the durability/quality of materials and their energy performance. But, *how can the cost be justified?* The high degree of uncertainty about the next few decades makes any investment in flexibility less valuable, regardless of intentions. For this reason, the concept of flexible design may be largely restricted to 1) accommodating changes that are expected to occur in the very near future, 2) applying simple, common-sense principles that are known to facilitate a wide range of possible changes, 3) incorporating adaptive features that can be justified for other reasons; or 4) adopting features that enhance flexibility with little or no additional capital and resource investment. The Agile framework highlights two kinds of changes that can influence the *economic sustainability* of flexible designs. First, incentives can and should be incorporated into new public policy directed at sustainable urban development. Second, businesses can commit to the basic principles of sustainability and adjust their behaviour accordingly—a mindset shift to prioritize both the health of people and the environment over profit. A design team that is committed to sustainable, environmentally-sound building needs to take the extra effort to identify opportunities for enhancing flexibility as well as estimating the related cost and environmental advantages.

Affordability has always been an issue in housing, and with the current recession, rent and mortgage crises are not farfetched. Affordability is not only a political, social, and economic issue but a design problem as well. The failure of *good design* consideration (see Gordon 3L principles in Imam and Sinclair, 2020) has helped create problems with the affordability of homes and the failure of many government initiatives (Lowery, 2020). One of the reasons that many people cannot afford a home is that there are limited choices in the size of units (Rohe and Watson, 2018, P. 146). Instead of producing alternatives for the market, the industry left the issue of *affordability* to government policies and programs—proving that policy alone is not the solution; a more integrative holistic framework is key. The housing industry provides a tradition of *driving until you can buy*; a saying that came out from how affordability in housing is

linked by its location away from the city. However, in addition to social demand considerations discussed earlier in this paper, —the commute time and cost, and carbon footprint of gas—, in most cases, removes any financial savings one might achieve by living further away. This practice also ignores the elderly who may be priced out of their homes, and can no longer drive, as well as the single parent who may not be able to afford both the time to commute and the cost for childcare (Bohm, 2018). These are just a few examples of how impactful design decisions are on not only the economic position but also social and environmental placement. The economic and social disruptions caused by the coronavirus proves that we have the capacity to fundamentally adapt our living patterns—prioritizing sustainability over profitability. Flexibility features—within an Agile framework—has great potential to provide some form of novel, affordable housing solutions, in essence offering more adaptive options so that buyers can find a home that fits within their budget in their desired community.

### 3.0 VISION AND PRINCIPLES FOR AGILITY

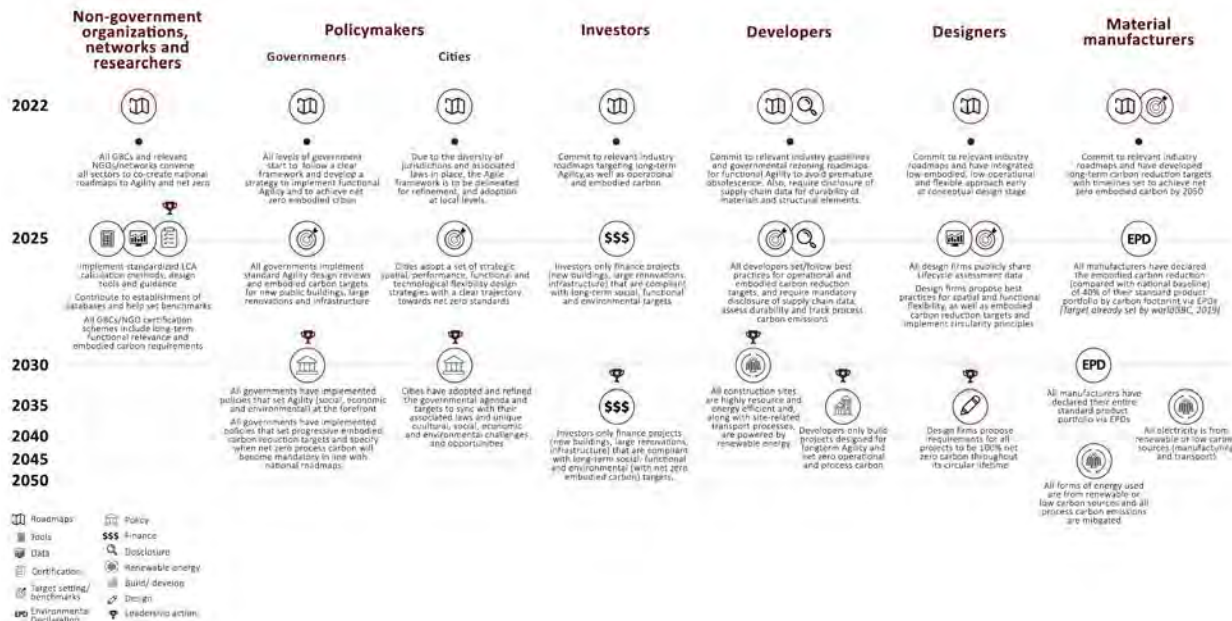
Agility can easily be mistaken for preparedness. Although being organized with the essentials will help, to some extent, respond to societies' changing demands, Agility is more about *creating the capacity* to continuously recover and heal. Prominently, the most influential branch of knowledge that governs our society is economics, much as ecology is the most influential branch of knowledge that governs nature (Pike, 2013). However, nature has a much stronger ability to withstand disturbances, and by linking these two central aspects of the world, we can gain insight as to how to best *respond and thrive with change*. Agility is used in ecological literature to describe the behaviour of nature. There are currently two dominant theories of how Agility is achieved: *engineering agility* and *ecological agility*. Engineering agility, much like static design mindsets, refers to the idea that “everything functions in one global stable state and agility is the time it takes the system to return to normal capacity after a disturbance.” Ecological agility, on the other hand, recognizes that there are *multiple stable states or equilibria* (Holling, 1996, p. 33). In other words, engineering agility focuses on the efficiency of function, while *ecological agility* focuses on the ability to maintain a functioning system by absorbing change. The AEC industry has been dependant on this *stable state* mantra as the main source of guidance for dealing with *change*, particularly *climate change*, due to the pervasive influence of the economy in society. In the context of the Agile framework proposed in the present research, *ecological agility* theories are strategic to attain with a “conceptual connection to the essence of the original community that values both the identity and interactive patterns of its members and prioritizes maintaining them” (Scribner and Herzer, 2011). Nabeel Hamdi in his book: *The Placemaker's Guide for Building Community*, stressed that “architects should be the catalyst and the community should be the agents for change, not the reverse” (Hamdi, 2010, p. 11). The Agile perspective proposed in this research realizes that community belonging is not solely about location; it's about association and meaning. If we look to nature, it thrives even with instability and uses disturbances to derive *agility* from exploiting the new opportunities and information available in the disturbed situation (Holling, 1996, p. 41). In this regard, the authors argue that an international model guideline is demarcated for when community members are required to collaborate, they will recognize the best solutions for themselves, unlike outsiders to the community. Although the solutions developed may not always be permanently effective or for everyone, “the engagement between the community members is the function and behaviour of the community that sustains it” (Holling, 1996, p. 37). The Agility gained from this empowerment will help the community manage *change*, or disturbances better. Subsequently, the present research contextualizes the tangible aspects of ecological agility, namely, psychological, physical and operational elements, to formulate the theoretical paradigm of Agile architecture.

### A CONCLUSION AND A BEGINNING

*“If a building does not support change and reuse, you have only an illusion of sustainability...”* (Croxtton, 2003, p. 147)

In conclusion, some key targets are defined to transform *flexible* architecture from a mere occasional intervention to an opportunity for environmental, social and economic development. Figure 2 illustrates the authors' vision map highlighting the holistic responsibilities of various stakeholders in our path to meaningful sustainability. Cities and communities must adapt as new industries emerge and as the demand for housing and the nature of the workplace changes. The present research argues that achieving flexible buildings lies in a broadening of perceptions through a more balanced and integrated approach, the Agile approach. This response lies in a re-conceptualization of time that goes beyond matters of durability to a more nuanced view of a building as a socialized product constantly in the making, responding to a milieu of change. Ideally, the concepts of Agile design need to be closely connected to developers' profitability. It should translate into faster sales and reduced refurbishment costs. Often, buildings stand empty or deteriorate due to mismatches in zoning or costly regulations for upgrading buildings. It is possible that the greatest single improvement towards Agile buildings is the strategic removal of the institutional obstacles that prevent affordable transformations of the built environment. As an industry, we have a proven set of techniques for designing homes and we know few best practices for building physical flexibility. But when it comes to innovation and designing for change, we are still shooting in the dark. We are relying on vision or chasing the “good designers” who can make magic happen. The present research attempts to put *designing for change* on a rigorous footing. In this new reality we live in, where work and living patterns are rapidly changing, we are at the dawn of a revolutionized architecture. It is our challenge to do our part to help create a functioning society that supports people without threatening life on Earth, including our own. In many respects, this research is about the *future*, about changing conservative design thinking where ideas are at best variations of the status quo. The unprecedented consequences of COVID-19 and climate change, mark what the

authors see as the *beginning of the end* of traditional architecture design. Incongruously, almost every traditional AEC organization, while trying to figure out its place in this changing world, is stubbornly trying to build a bulwark to protect old models that can't possibly survive the sea of change under way. Thus, from the authors' perspective, if *change* is the new problem then *Agility* is the new solution.



**Figure 2.** Proposed vision map highlighting the holistic responsibilities of various stakeholders in our path to meaningful sustainable built environment. Each metric is categorized in terms of “action type.” Whether its developing roadmaps, initiating certifications, enforcing policy and benchmarks, or the need for new tools and data transparency. This map guides the research to defining the strategic priorities of the forthcoming framework.

## REFERENCES

- 3DReid, 2006. *Multispace: adaptable building design concept. Case study edn*, London: Reid Architecture.
- Arge, K., 2005. *Facilities. Adaptable office buildings: Theory and practice*, 23(3-4), p. 119–127.
- Brand, S., 1995. *How Buildings Learn: What happens after they're built*. New York: Penguin Books.
- Bohm, C. C., 2018. *Affordable Housing Design for Place Making and Community Building*. In: *Chasing the American Dream*. s.l.:Cornell University Pres, p. 113–145.
- Croxton, W., 2003. *Disassembly and Deconstruction*. s.l.:Architectural Record.
- Fawcett, W., 2011. *Investing in flexibility: The lifecycle options synthesis*. Cambridge, U.K, Projections 10: The MIT Journal of Planning.
- Fernald, M., 2019. *THE STATE OF THE NATION'S HOUSING*, Cambridge, MA: JOINT CENTER FOR HOUSING STUDIES OF HARVARD UNIVERSITY.
- Fiume, F. and Albatici, R., 2018. *EMERGENCY ARCHITECTURE FOR SOCIAL AND ECONOMIC DEVELOPMENT: A STATE OF THE ART*. Naples, Italy, 42nd IAHS WORLD CONGRESS. The housing for the dignity of mankind.
- Gijsbers, R., Cox, M.G.D.M., Haas, T.C.A.D., Kok, P. and Hulsbergen, H., 2009. *Development of amembrane roofing system with integrated climate control for community shelters*. TU/e Delft University of Technology, 5-19 June, Development of amembrane roofing system with integrated climate control for community shelters”, in Dobbelsteen, A., Dorst, M. and Timmeren, A. (Eds), Smart and Sustainable Built Environments, pp. 1-8.
- Habraken, J., 1972. *Supports: An Alternative to Mass Housing*. English edition ed. London: Urban Press.
- Hamdi, N., 2010. *The Placemaker's Guide to Building Community*. 2016 ed. Washington, DC: Earthscan.
- Hayden, D., 2002. *Redesigning the American Dream*. New York: W. W. Norton & Company.
- Holling, C. S., 1996. Engineering Resilience versus Ecological Resilience. In: P. Schulze, ed. *Engineering Within Ecological Constraints*. National Academy of Sciences, pp. 32-42.
- Imam, S. and Sinclair, B., 2018. *Dysfunctional Design + Construction: A Cohesive Frame To Advance Agility + Sustainability*. Philadelphia, ARCC-EAAE International Conference, pp. 415-423.
- Imam, S. and Sinclair, B., 2020. *Designed to change: The future of architecture is Agile*. Valencia, Spain, EAAE-ARCC INTERNATIONAL CONFERENCE & 2nd VIBArch.
- Imam, S., 2020. *BUILDING Magazine: Coronavirus and the Road to Climate Change Recovery*. [Online] Available at: <https://building.ca/feature/coronavirus-and-the-road-to-climate-change-recovery/> [Accessed July 2020].

- Irfan, U., 2019. *Vox. 113 degrees in France: why Europe is so vulnerable to extreme heat. All-time temperature records have been broken in the heat wave sweeping the continent.*-2019-europe-france-germany-spain [Accessed 28 05 2020].
- Kendall, S. and Ando, M., 2005. *Theory and methods in support of adaptable buildings*. Tokyo, 27-29 September, Action for Sustainability–The 2005 World Sustainable Building Conference.
- Keymer, A., 2000. *Design strategies for new and renovation construction that increase the capacity of buildings to accommodate change*, s.l.: Massachusetts Institute of Technology. Dept. of Civil and Environmental Engineering.
- Kock, R., Karesh, W., Veas, F., Velavan, T., Simons, D. and Mboera, L., 2019. 2019-nCoV in context: lessons learned?. *The Lancet Planetary Health*, 4(3), pp. E87-E88.
- Kronenburg, R., 2007. *Flexible: Architecture that Responds to Change*. 1st edition ed. London: Lawrence King Publishing.
- Marcus, C. C., 2006. *House As a Mirror of Self: Exploring the Deeper Meaning of Home*. s.l.:Nicolas-Hays.
- Mcilwain, J., 2010. *Housing In America*, Washington, D.C.: Urban Land Institute (ULI).
- Nascimento, D. M., 2012. John Habraken Explains The Potential Of The Open Building Approach. *Open House International*, 37(4), pp. 5-13.
- Pak, A., 2019. *Embodied Carbon: The Blindspot of the Buildings Industry*. [Online] Available at: <https://www.canadianarchitect.com/embodied-carbon-the-blindspot-of-the-buildings-industry/> [Accessed March 2020].
- Pike, C., 2013. *Climate resilience: Deconstructing the new buzzword*. [Online] Available at: <https://www.greenbiz.com/article/climate-resilience-deconstructing-new-buzzword> [Accessed June 2020].
- Ratcliffe, J., Stubbs, M., 1996. *Urban Planning and Real Estate Development*. s.l.:UCL Press.
- Rawlinson, S. and Harrison, I., 2009. Cost model office refurbishment. *Building Magazine*, 10(3), pp. 48-53.
- Richter, U. L. A., 2005. *The adaptable tall building*, Leipzig: LACER.
- Rohe, M. W. and Watson, L. H., 2018. *Chasing the American Dream: New Perspectives on Affordable Homeownership*. Cornell University Press.
- Scribner, M. a. H. L. ed., 2011. *AFTER THE DISASTER: REBUILDING COMMUNITIES*. Washington, DC, A Fetzer Institute / Woodrow Wilson International Center for Scholars.
- Scuderi, G., 2019. Designing Flexibility and Adaptability: The Answer to Integrated Residential Building Retrofit. *Designs*, 3(1).
- Sinclair, B., 2009. Culture, Context, and the Pursuit of Sustainability. *Planning for Higher Education (PHE)*, Issue 38, pp. 6-22.
- Till, J. and Schneider, T., 2007. *Flexible Housing*. 1st edition ed. Burlington: Elsevier.
- UN Environment and International Energy Agency, 2018. *Towards a zero-emission, efficient, and resilient buildings and construction sector. Global Status Report*
- Verweij, S., Poelman, W.A., 2006. *valuation of flexibility options in different housing projects*, TU/e Delft University of Technology, Delft, 3-5 July, Proceedings of the Joint CIB, IASSInternational Conference (Adaptables 2006), pp. 38-42.
- Wilkinson, S.J., 2014. How buildings learn: adaptation of low grade commercial buildings forsustainability in Melbourne. *Facilities*, 32(7/8), pp. 382-395.
- Wilkinson, S.J., 2014. How buildings learn: adaptation of low grade commercial buildings forsustainability in Melbourne. *Facilities*, 32(7/8), pp. 382-395.
- Yates, A., 2003. *ustainable Buildings: Benefits for Investors and Developers, IP 13/03, Part 3*, London: Building Research Establishment.



# ***Ostenda illuminata*: A Socio-Ecological 1:1 Prototype for Networked Public Spaces**

Mona El Khafif<sup>1</sup>, Andrew Mondschein<sup>1</sup>, Luis Felipe R. Murillo<sup>2</sup>

<sup>1</sup>University of Virginia School of Architecture, Charlottesville, VA

<sup>2</sup>University of Virginia School of Data Science, Charlottesville, VA

**ABSTRACT:** Deployments of sensor networks and control systems in public space are central to what has been called "Smart Cities." These deployments, often manifesting as technologies embedded within existing infrastructures, are championed as key drivers of more optimized and sustainable cities. However, hidden and unaccountable infrastructures can alienate citizens and undercut even the positive social goals "Smart City" projects claim to support, creating serious challenges for data protection and privacy. Grounded in a conceptual framework prioritizing meaning generation, imageability, open and responsive infrastructures, *Ostenda illuminata* (trans. revealed illumination) problematizes the implementation of "Internet of Things" in urban public spaces. Sustainable, community-centered urban sensing technologies are not just a problem of technological choice and reliability but collective governance, process, and form of open sensor infrastructures and data. In this context, *Ostenda illuminata* is a prototype for placemaking in urban public spaces. Utilizing urban sensing to gather information about its environment, it responds in real-time patterns of illumination *in situ* as well as through online networks. *Ostenda illuminata* uses open and accessible technologies for sensing and technology-embedded architectural response elements that can be distributed variability within single or multiple public spaces. To underscore the problematic "monoculture" approach to embedded technologies currently dominant in Smart City design, *Ostenda illuminata* is conceptualized as a model for a legible social ecology of techno-material architectures, installations, and systems. By integrating forms, technologies, and processes within open networks that are legible and responsive to a diversity of individuals and groups, *Ostenda* locates a "middle ground" between infrastructural sensor fabric initiatives and bottom-up technological projects. The project identifies a critical role for designers within multi-disciplinary networks of governments, companies, and communities operating in the digital public realm and offers a model of networked public space that fosters meaning generation with openness and responsiveness for the broadest group of participants.

**KEYWORDS:** sensor networks, public space, open systems, place making, responsive architecture

## **1.0 INTRODUCTION**

Offenhuber and Schechtner (2012) identify historical paradigm shifts, in a European-North American context, in the relationship between the public and urban infrastructure. In the techno-euphoric late 19th and early 20th century, new urban infrastructure was publicly celebrated as evidence of civic progress. As infrastructures were normalized, these systems were absorbed by the urban fabric, partly hidden below ground and blended into the everyday culture of the city. At the turn of the 21st century, urban fabrics are being reimagined and disputed through another paradigm, in which physical infrastructures are meant to be enhanced by digital technologies raising questions of materiality and management, but also allowing for the emergence of a novel byproduct: the "datafication" of environmental, social, and technical processes at scale (van Dijck 2014; Zuboff 1988, 2019). Within this paradigm, "smart" infrastructures with the "Internet of Things" represent a radical departure from the traditional infrastructures of the last century. This "integrated infrastructural ideal" (Graham & Marvin, 2002) has started to materialize as a fragmented mesh of digital infrastructures and sensor networks that are rightfully criticized because of their hidden nature and top-down data collection and governance. A connected urban realm is inherent to the Smart City concept, but its development is primarily driven by private actors and engineers with limited engagement to address the relationship between the public and the emerging sociotechnical landscape. The urgent question raised at this point in history is how digital technology, with its (im)material, data-generating, and functional specificities can, in combination with traditional urban infrastructure, constitute public spaces that foster just and sustainable socio-ecological living.

This paper presents *Ostenda illuminata*, a prototype that seeks to address the problem of networked public space with open design techniques to create an alternative to the top-down, totalizing strategies of the Smart City and the bottom-up aspirations and needs of diverse collectives. Actor-network theory (Latour, 1996) emphasizes the multiplicity of interactions among the built environment, technologies, and human actors at play in emergent public spaces. In this framing, a *networked* public space must rigorously identify modes of meaning-generation and collective governance for placemaking of physical and virtual environments with an emphasis on the deployment of data infrastructures and



analytics for social justice. Networked public spaces must specify and operationalize mediation between top-down and bottom-up, across design processes, data privacy and governance as well as materiality and form of infrastructures. To address this *Ostenda* is realized through a cross-disciplinary and multi-agent collaboration involving urban designers, planners, engineers, social scientists, as well as community members. This paper describes the design of a performative urban infrastructure, integrating sensors and networking capabilities within materially and formally distinctive architectural typology. First findings show that broad goals of formal legibility and social justice in public space require open approaches to technology, data, and design. The paper concludes with a discussion of implications for urban public space design and future research.

## 2.0 DESIGNING NETWORKED PUBLIC SPACES: ALTERNATIVES TO THE SMART CITY

Smart City conceptualizations of urban public space typically privilege efficiency and systems integration, reframing prospective planning or design as problems of day-to-day management (Batty, 2013; Yates, 2017). Proponents have highlighted the value of networked information technologies, urban sensing, and algorithmic optimization to address longstanding socio-economic and ecological challenges facing cities and their public spaces. While these applications are often linked to ongoing government policies and social objectives, the integration of sensors, networks, and large-scale analytics tends to reinforce control from the top-down by establishing one-way systems of data collection and keeping the technologies at play largely invisible and unaccountable to citizens and their communities (Houston, Gabrys, and Pritchard 2019). Free and Open Source (FOSS) technologies have facilitated local and global efforts to collect data in urban environments by community members, often using open data sets to advocate for social and environmental change through political action (Brown et al., 2016; Singer, 2016; Murillo, 2016). This bottom-up approach, however, has so far only had temporary or indirect effects on the form and use of public space, lacking systematic, replicable approaches to urban design and planning that cities and other controlling actors require for permanent installations. Additionally, while its technologies and data are fully free and open, opportunities to engage with open technologies are often limited to citizen scientists and others with specific types of technical expertise, rather than being legible and actionable to a broad populace.

Within this problematic space between top-down and bottom-up approaches, open design possesses the capability to identify organizations of social, ecological, and technological relations. These have the potential to generate meaning through the design process itself, as experienced space, as well as analytically for the purposes of collective governance and planning. Making these complex networks not just functional but visible and modifiable by community members is a normative goal that can align networked public spaces design with community-centered theories (Mondschein et al., 2018).

The role of design in facilitating community-centered legibility and agency within a technology-supported public space may derive from its ability to establish patterns within a social, spatial, and technical system that are evident to more than just experts, makers, or government and corporate actors. This includes the design of tools like interactive web interfaces that allow for multi-authorship and productive collaboration (El Khafif et al., 2018). Furthermore, the ability to establish patterns is one of design's core capabilities and approaches to public space (Alexander et al., 1977). Legibility can be implemented not just in an architectural, spatial sense, but also across the technologies, environments, and socio-political processes at play in public spaces. Goodbun et al. (2014) highlights the importance of design thinking, the development of spatial agency, and the facilitation of open access to politicize spatial challenges. Given this framework, a "networked public space" in the contemporary city has multiple meanings:

1. a public space that is connected to a network,
2. public spaces that are connected to each other through networks,
3. a design strategy that connects multiple components of public spaces: a) stakeholders: users, communities, administrators, designers; b) physical environments: public space artifacts, multifunctional installation and public art in a spatial setting; c) digital environments: generated data, public web interfaces.

Our central research question therefore asks: what kind of public space design can facilitate a process-oriented, trans-disciplinary, and multi-actor collaboration in support of a community-oriented, broadly legible, and responsive networked public space?

## 3.0 OSTENDA ILLUMINATA: A 1:1 PROTOTYPE

*Ostenda illuminata* is a project manifesting in public spaces. Utilizing an urban sensing approach to gather information about its environment, the species responds in real-time through patterns of illumination *in situ* as well as through network connections. The species consists of multiple ecologies and multi-agent components that define its typological architectures, responsive technologies and codes, as well as stakeholder engagement. The concept of ecology is here applied as a way of conceptualizing interactions (Goodbun et al., 2014) between the different project components and the emergent behavior that it produces. As such it can be compared with a living system that consists of architectural, technological, and digital components as well as human related interactions and reactions that are embedded in an environment and connected through the Internet (Figure 1). The project in its first prototype consists

of three distinct layers: physical artefact, digital infrastructure, and social engagement. While most responsive architectures are defined by their physical space and software design, the *Ostenda* model integrates an organizational structure that allows communities to actively participate. This organizational space (Läpple, 1991; El Khaffif, 2009) serves as an integrated framework to facilitate connectivity, collaboration, and open access as well as collective ownership of environmental data. In the physical realm, *Ostenda* responds through illumination. In the online realm, publicly available data and analytics are presented to reveal and contextualize changing environmental conditions. In the social realm, *Ostenda* responds to human interaction and environmental conditions, but, more importantly, seeks to advance data literacy through digitally mediated public spaces.

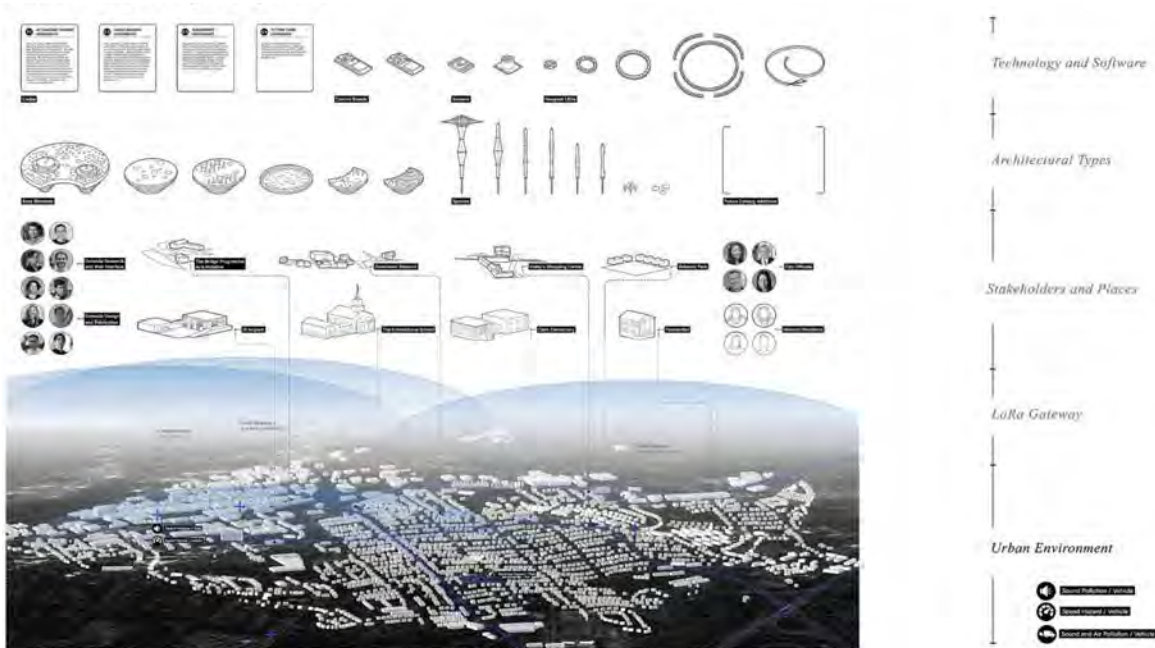


Figure 1: Ostenda illuminata: An Ecology of Systems. Source: (Authors)

### 3.1 Architectural Typologies and Kit of Parts

To embrace a form finding process based on parameters of digital fabrication and readily available components, *Ostenda illuminata* is composed of a series of circle and ring-based geometries (Figure 2). The system consists of solid elements (defined as the ground) and a series of elements that live on this ground (defined as species). The responsiveness of the system is facilitated through digital technologies that connect the different elements to a larger ecology.

*Architectural Typologies:* A series of architectural types define the ground and the species. The ground consists of solid islands of varying diameters and heights that establish a topography and multifunctional aggregation. This system is serving as a shell to host the sensors, network nodes, and power sources that connect to the plant species living on the solid base. Each island is defined by its size and potential performance based on species and sensor kits. The aggregation consists of 3 different island sizes (Figure 3) designed for human scale occupation with integrated seating elements that serve as public furniture elements. The islands themselves are populated with an ecology of 6 different species. The surface is perforated with openings that function as illuminated earth holes to reach the technology. Moss organized as connected patches of small responsive light elements create a field that illuminates when approached. Shrubs, consisting of shorter and larger more spatial elements, are responding to immediate noise through their light illumination and brightness. The largest species, the trees, consist of a canopy and a trunk. These species are most complex in the forest ecology. They collect sound data over the day and calculate aggregated noise pollution to communicate when thresholds are violated through bright red-light illumination (Figure 4).

*Kit of Parts:* The architectural typologies are not understood as a form-based object, but a modular kit of parts that can aggregate through iterations and can consist of various numbers of elements. Through applied patterns, these ground typologies and species typologies are understood as a networked field. They can adjust to different settings and as a system they can expand and evolve through future prototypes. Essential to the kit of parts is its integrated responsive technology (Figure 5).

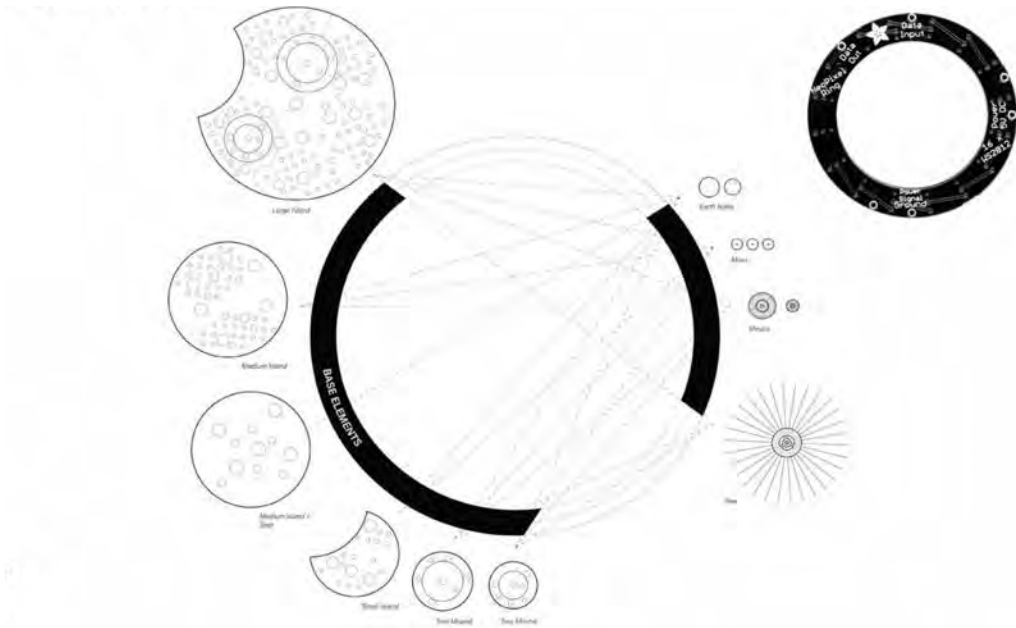


Figure 2: Ostenda illuminata: An Ecology of Typologies. Source: (Authors)

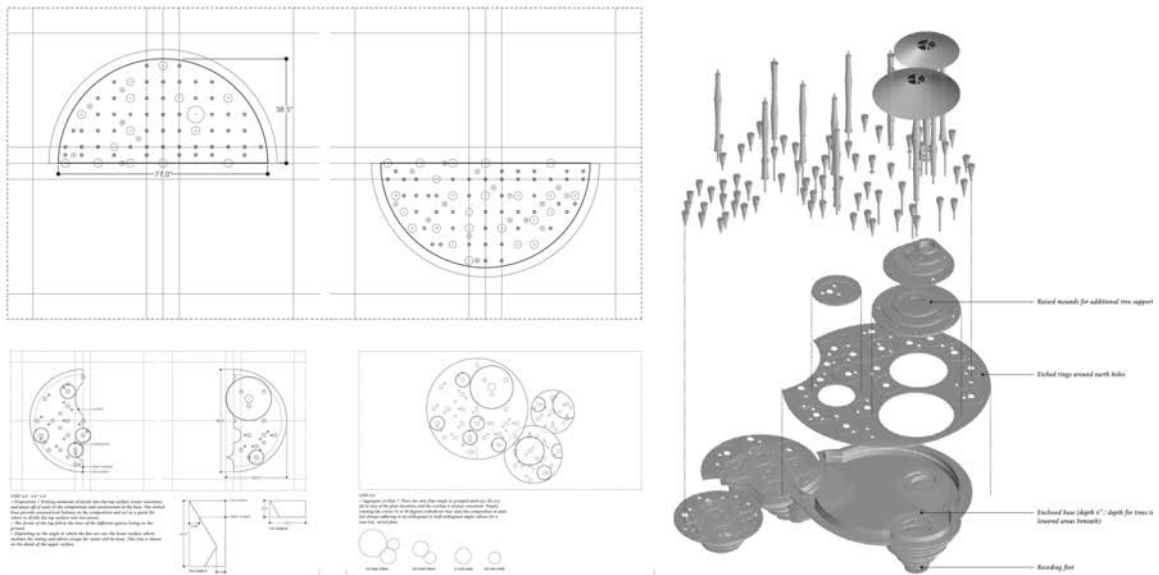
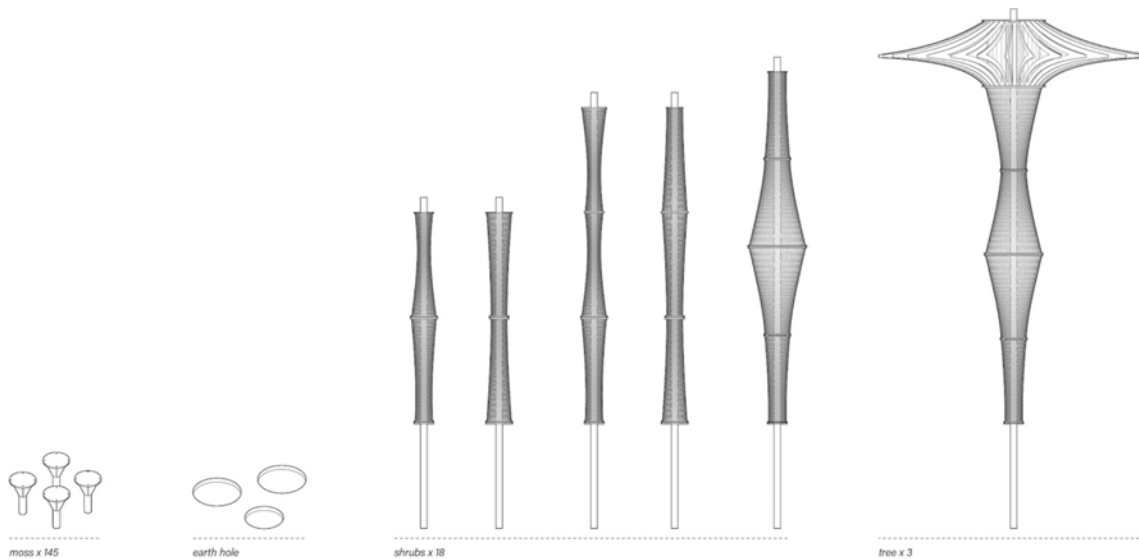


Figure 3: Ostenda illuminata: Ground and Species. Source: (Authors)



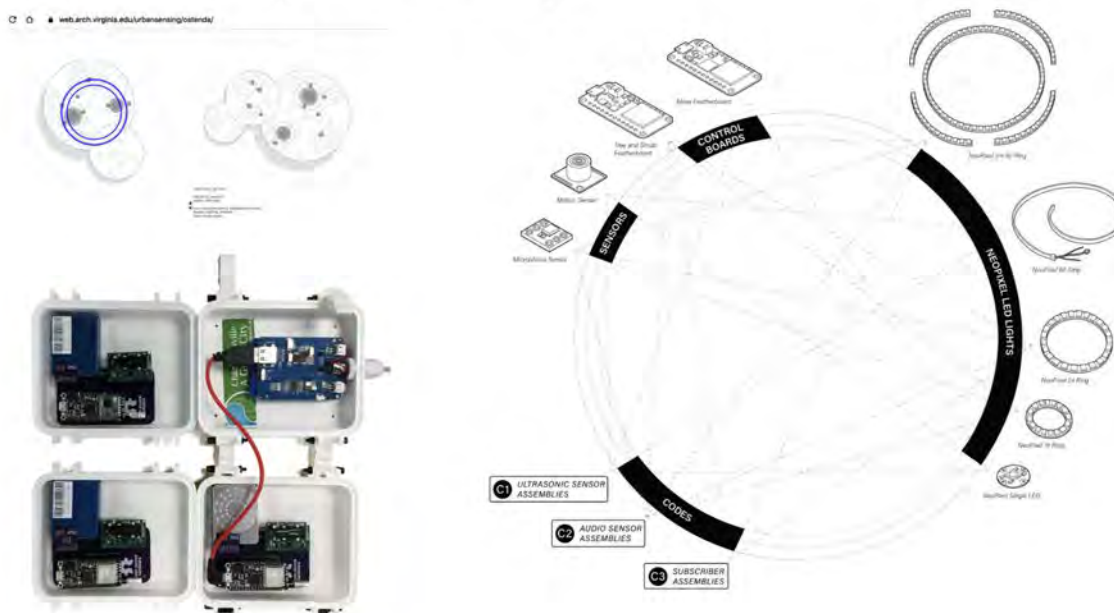
Figure 4: Ostenda illuminata: Noise Response. Image Credits: (Authors)



**Figure 5:** Ostenda illuminata: Inventory of Responsive Species. Source: (Authors)

### 3.2 Responsive Technologies and Real-time Data Collection

The set of digital technology is similarly organized like the architectural system and can be understood as a kit of parts that consists of hardware and software components (Figure 6).



**Figure 6:** Ostenda illuminata: Inventory of Hardware and Software, Image Credits: (Authors)

*Responsive Technologies:* The first prototype, developed for an indoor setting, aimed to establish a free and Open-Source hardware kit of parts utilizing audio and proximity sensors to test sound pressure levels in the environment and energy-saving illumination. An ultrasonic sensor array was used to detect proximity, while being connected through a microcontroller (Adafruit Feather M0) to activate a patch of LEDs (Moss), mirroring the zone covered by the sensor's beam path. Signals from the array of ultrasonic sensors control the brightness of the LEDs based on proximity. The closer an object is to the sensor, the brighter the LEDs will shine. Once an object is out of a defined range (1m), the LEDs receive a signal to fade them in and out at low brightness levels. The sound pressure sensing utilizes a calibrated I2C microphone. Sound pressure (ambient noise) data is fed into a buffer to process sound pressure levels before being published. Data are transmitted from an ESP32 microcontroller to a web service via MQTT with the corresponding noise levels in decibels (dB) after being interpreted by a state machine to define the strength of the PWM signal sent to the Shrubs. The greater the decibel level, the greater the brightness and color saturation expressed by the LEDs on the shrubs. Once decibel levels rise above the damage threshold of human hearing, the LEDs will be at full color



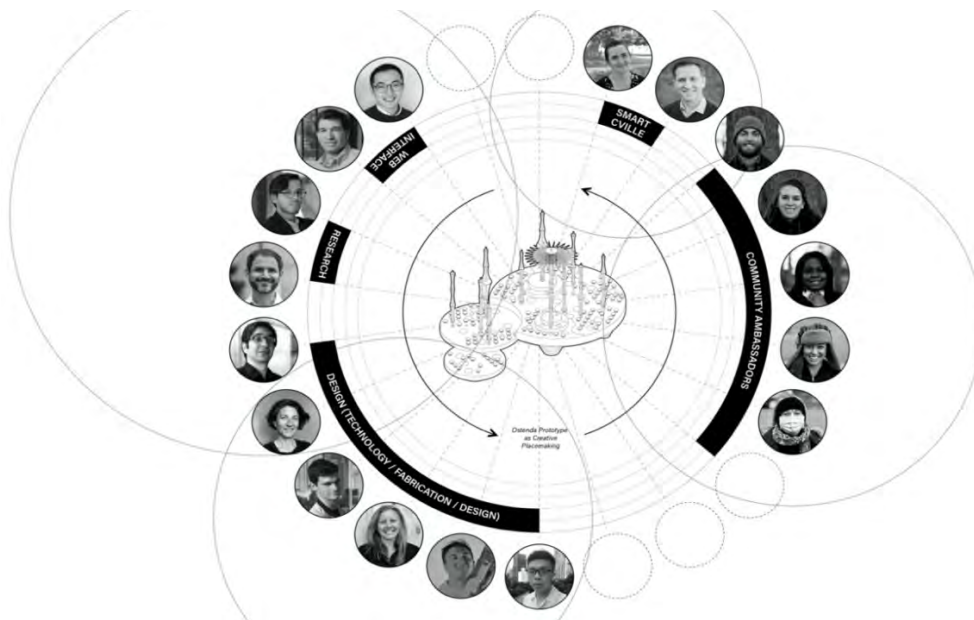
saturation until levels fall back into a safe range. This performance is displayed in the tree species. Future prototypes will include a catered selection of sensors based on community needs and the challenges detected at the deployment site. Air quality sensors can track carbon dioxide (CO<sub>2</sub>), carbon monoxide (CO), nitrogen dioxide (NO<sub>2</sub>), ozone (O<sub>3</sub>), and particulate matter (PM) of 2.5 and 10 micrometers (dust, dirt, pollen).

*Code:* The code driving the ultrasonic array takes 10 readings into a buffer, averages and scales them to produce the LED output signal. The ESP32 connected to the sound pressure sensor is primarily focused on acquiring data, writing to the LEDs, and transmitting readings to the MQTT server. After the readings are filtered, the state machine checks if the reading is within a certain range. Depending on which range the reading falls, the ESP32 will send out a corresponding PWM signal to the LEDs. It is safe to assume that the code for the future prototype iterations will be generally similar to those operating Ostenda. Sensor readings will be taken, averaged, scaled, and written out as a signal to actuate response and transmitted to a server over WiFi or LoRa wireless protocols.

*Real-Time Data Collection:* To allow community members to be informed of environmental changes of collective interest, all data are stored in a timeseries database and featured on a publicly accessible web-based real-time data visualization. Data collection and environmental sensing are meant to illuminate environmental conditions that vary over time and to address public health concerns that are less identifiable through human senses. Micro controllers with network capabilities can connect local networks to distribute sensor data using MQTT protocol. The MQTT server mediates between the installation and web API of the data visualization tool. LoRa networks are convenient to allow for long range and low-power applications, whereas knowledge of the underlying sensor network technologies is essential for the sustainability of the deployment in the public interest.

### 3.3 Community Engagement

In parallel with the kit-of-parts model for formal and technological components, engagement is predicated on working with communities throughout the public space planning process, identifying needs, potentials, and design strategies that are most relevant and responsive to the community. The engagement process for our project has been prototyped in the Belmont neighborhood of Charlottesville, Virginia, USA. Resident and institutional stakeholder groups represent the diversity of demographic and institutional voices required for the success of a public space design (Figure 7).



**Figure 7:** Ostenda illuminata: A Network of Participants. Source: (Authors)

Engagement so far has focused on identifying how *Ostenda's* techno-material kit of parts could be applied in the neighborhood in ways that leverage both formal and data-driven components to increase environmental knowledge, meaningful interaction, and effective planning in the neighborhood. While the engagement has been impacted due to COVID pandemic, the process includes a public consultation to define the "code of conduct" for the public network, as well as public activities such as neighborhood walks to identify needs and opportunities for collaborative sensing. Notably, the responsive nature of the prototype, as well as its form echoing organic species, has been very successful in helping stakeholders with no background in technology or public space design understand the potential of the project. For example, the director of a local senior organization observed that the model has significant potential to link seniors seeking to interact with other humans with younger people possessing greater technological facility. These types of

multi-dimensional actor networks, linking space, technology, and diverse community members, are critical to the success of a networked public space design.

#### 4.0 FINDINGS: A MULTILAYERED SOCIO-ECOLOGICAL SYSTEM

The *Ostenda* prototype and approach that emerged from the design process leads to a series of findings:

- The integration of participatory principles can only be facilitated through a multilayered approach in which the design of the physical project is linked to technological protocols and stakeholder engagement.
- In order to facilitate meaningful co-production of knowledge across social, technical, and experiential dimensions, the open design was carried out with a “kit of parts” approach. The design of an open sociotechnical system allows spatial adjustments through diverse configurations to address positive and negative environmental conditions, and sensor kits can address different environmental concerns depending on communitarian needs and goals. Different sensors (e.g. UV, allergens, air quality) could be included in the open framework established by *Ostenda illuminata*.
- The visual effects and the human scale of the installation responding to sound and proximity events triggers immediate engagement and excitement also among stakeholders that so far were not engaged with networked sensing technologies. This excitement helps with the engagement process as the installation is both a piece of public art and a networked artifact facilitating a collaborative learning of sensing technologies (Figure 8).
- The design uses open-source technologies to allow engagement at multiple levels of technical skill. This facilitates a collaborative process allowing for design workshops and fabrication modules offered by local groups like schools and art institutions. The prototype includes the open hardware kit of a low-energy board (librelab: Big Dot) with support for popular coding platforms for interactional designers (such as Arduino), plus example codes for beginners.
- Responsive installations enable countless visual effects and sensing affordances. Decisions concerning the sensing kit and the definition of the adequate thresholds for air pollution, for example, are critical components of the project. The performance depends on feedback from expert and community members alike, while their encounter fosters knowledge sharing and empathic understanding.
- *Ostenda illuminata* is developed as a trans-disciplinary and multi-agent collaboration to define the technical, regulatory, and behavioral parameters within networked public spaces. The interdisciplinarity of this team and its partners diversifies the production process itself. Professionals, city administrators, and community members contribute their expertise to the development of a project and its spatial agency.
- The project focuses on environmental sensing in physical public space as well as the virtual realm via network interconnection with a web interface. After working with the community and institutional stakeholders in Belmont, it became clear that a project like this can be of significant value when located in settings that are impacted by social and environmental injustice.



Figure 8: *Ostenda illuminata*: Public Art. Source (Tom Daly, 2020)

- To facilitate a middle-ground positioning, it is critical that data governance, openness, and ownership remains in public and community hands. The web interface allows for public access, but also for public download of data that are suitable for sharing (as defined by community goals and needs). The kit of parts and its source files are likewise publicly available for download. While the web interface is currently stored on an institutional server, it will be important to facilitate a community-owned and controlled platform in the near future.



## 5.0 NEXT STEPS: CREATIVE PLACEMAKING IN THE DIGITAL CITY

The *Ostenda illuminata* prototype is as much the design of a physical responsive ecology as it is the initiation of a learning environment in the public interest. Future research deploying the prototype will explore how networked public space affects collective action. Moving forward, the team has facilitated a partnership with the City of Richmond, Virginia, USA to work on a site that faces environmental injustice to install the next prototype. The Shockoe Bottom neighborhood is located directly under an interstate highway overpass. The historically African American neighborhood along the highway were first destroyed when the infrastructure was constructed in the mid-20th century and today remain impacted by environmental pollution. In collaboration with local stakeholder groups, this team suggests a creative placemaking strategy as a direct response to the loss of place caused by the urban renewal policies, and is an integrated approach that combines geographic, social, and material aspects (Courage, 2017). As placemaking is an inherently networked process in which socio-spatial relationships link multiple stakeholders to a common place-frame (Pierce, Martin, & Murphy, 2011), it can also be extended through the implementation of public art to facilitate a creative placemaking project (Markusen & Gadwa, 2010). Creative placemaking through networked public spaces is still a novel agenda, and the next prototype has the opportunity to address one of the most devastating urban renewal policies in planning history. It will also shed light on a new dilemma of the Smart City: the infrastructural affordance to sense everything and everyone, but not to be sensed and understood by the public.

## REFERENCES

- Alexander, C., Ishikawa, S., Silverstein, M., Jacobson, M., Fiksdahl-King, I., & Angel, S. (1977). *A Pattern Language: Towns, Buildings, Construction*. Oxford University Press.
- Batty, M. (2013). Big data, smart cities and city planning. *Dialogues in Human Geography*, 3(3), 274–279.
- Brown, A., Franken, P., Bonner, S., Dolezal, N., & Moross, J. (2016). Safecast: Successful citizen-science for radiation measurement and communication after Fukushima. *Journal of Radiological Protection*, 36(2), S82–S101.
- Courage, C. (2017). *Arts in place: The arts, the urban and social practice*. New York: Taylor & Francis.
- El Khafif, M., Zhang, Z., Mondschein, A., (November 2018). *Mapping the Nocturnal City: Community-Centered Urban Sensing in Charlottesville*. CityStreet# Conference Proceedings, Beirut, Libanon.
- El Khafif, M., (2009). *Inszenierter Urbanismus. Stadtraum für Kunst, Kultur und Konsum*, VDM Publisher
- Goodbun, J., Till, J., Rumpfhuber, A., & Klein, M. (2014). *The Design of Scarcity*. Strelka.  
<https://westminsterresearch.westminster.ac.uk/item/q2x55/the-design-of-scarcity>
- Graham, S., & Marvin, S. (2002). *Splintering urbanism: Networked infrastructures, technological mobilities and the urban condition*. Routledge.
- Houston L, Gabrys J, Pritchard H. (2019). Breakdown in the Smart City: Exploring Workarounds with Urban-sensing Practices and Technologies. *Science, Technology, & Human Values*. 44(5):843-870.
- Läpple, D., (1991), *Essay über den Raum*, in "Stadt und Raum", H. Häussermann et. al. (Editors), Pfaffenweiler, Centaurus-Verlag.
- Latour, B. (1996). On actor-network theory: A few clarifications. *Soziale Welt*, 369–381.
- Markusen, A., & Gadwa, A. (2010). *Creative placemaking: How to do it well*. National Endowment of the Arts.
- Mondschein, A., El Khafif, M., & Zhang, Z. (2018, April). *Community-Centered Urban Sensing: Building Engagement into Data-Driven Local Planning and Design*. III International Conference URBAN E-PLANNING, Lisbon, Portugal.
- Murillo, L. F. R. (2016). New Expert Eyes Over Fukushima: Open Source Responses to the 3/11 Disaster in Japan. *Anthropological Quarterly*, 89(2), 399–429.
- Offenhuber, D., & Schechtner, K. (2012). *Inscribing a square: Urban data as public space*. Springer Verlag.
- Pierce, J., Martin, D. G., & Murphy, J. T. (2011). *Relational place-making: The networked politics of place*. *Transactions of the Institute of British Geographers* 36 (1): 54–70.
- Singer, B. (2016). A chronology of tactics: Art tackles Big Data and the environment. *Big Data & Society*, 3(2).
- van Dijck, J., (2014). Datafiction, dataism and dataveillance: Big Data between scientific paradigm and secular belief. *Surveillance & Society*, 12 (2): 197-208.
- Yates, J. (2017). Saving the Soul of the Smart City. *The Hedgehog Review: Critical Reflections on Contemporary Culture*, 19(2), 18–35.
- Zuboff, Shoshana. (1988). *In the age of the smart machine: The future of work and power*. New York, NY: Basic Books.
- (2019). *The age of surveillance capitalism: the fight for a human future at the new frontier of power*, PublicAffairs, New York.

# From String of Pearls to String of Parks: The Compelling Case of Doha, Qatar

Asmaa Saleh AL-Mohannadi<sup>1</sup>, Dr. Brian R. Sinclair<sup>2</sup>, Dr. Raffaello Furlan<sup>1</sup>, Dr. Rashid Saad AL-Matwi<sup>1</sup>

<sup>1</sup>Qatar University, Doha, Qatar

<sup>2</sup>University of Calgary + sinclairstudio inc., Calgary, Canada

<sup>1</sup>Qatar University, Doha, Qatar

<sup>1</sup>Qatar University, Doha, Qatar

**ABSTRACT:** Cities in the Arabian Gulf region have been increasingly global in perspective where the public realm and its components of streets, plazas and parks becomes dominant in the urban planning and design space, place, buildings, and landscapes. The present paper examines the changing approach to park design and place making in the Islamic City, using Doha, Qatar as an illustrative case. Since the discovery of oil and gas in the 1940's, Doha has faced accelerating urbanization. With a spectacular transformation from a modest settlement focused on pearl fishing to a dynamic international city with outward reach and global impact, Doha's urban fabric has developed in important directions. Over time, the city has created numerous less prominent and less tourist-oriented parks that serve local neighborhoods while together comprising an emergent and deliberate network. Such networks have manifold benefits, including heightened urban connectivity, promotion of biodiversity, provision of recreational amenity and the promotion of greater sustainability. They also contribute to a unique identity for Qatar -- landscapes that respond to local needs and physical circumstances -- helping to define and support a sense of place in a rapidly developing nation. Doha's commitment to exploring and realizing a comprehensive and integrated green network speaks to an awakening, globally and notably in the Gulf Region, regarding the demonstrable benefits of a well-designed environment to public health and community vibrancy. The authors contend that the promise of Doha, and lessons learned along its path of progression as a greener city, offer direction to other Islamic cities facing many challenges in an ever-changing and rapidly evolving world. The present research develops a conceptual framework that considers the resonance of architecture, landscape, and urban design in city planning, and advances initial guidelines for providing park networks that proffer greater amenity, heighten environmental responsibility, and improve quality of life. It also underscores that there are common principles that can be understood in addressing enrichment through landscape, while concurrently emphasizing the imperative to respond to and celebrate the nuances of place.

**KEYWORDS:** architecture, city planning, landscape architecture, sustainable urbanism, tactical urbanism, systems, holism, quality of life.

## 1.0 INTRODUCTION

Islamic cities are complex, dynamic and growing across the globe. In many instances, individual buildings, including housing, have remarkably beautiful and impressively functional interior courtyards. Serving to unify spaces and provide outside connections to often-compressed projects in densely developed urban fabric, such interior landscapes commonly invoke water, light, nature and ornamentation to bring serenity, respite and renewal to the inhabitants. They present moments of transcendence that serve to connect the environment to the user in deep and meaningful ways. In the case of city planning and urban design, historically there has been less emphasis on a heavily landscaped public realm. In the Middle East, for example, where water is scarce and arable land limited, the focus is on buildings, and the interior ethos, more so than on landscapes and the external sphere. As access to water has increased (e.g., through desalination), and cities in the region have been increasingly global in perspective, attention is expanding beyond the confines of private property to focus on and celebrate the public realm – including streets, plazas and parks. The present paper examines the changing approach to park design and place making in the Islamic City, using Doha, Qatar as an illustrative case. Since the discovery of oil and gas in the 1940's, Doha, the capital city of the State of Qatar, has encountered accelerating urbanization. With a spectacular transformation from a modest settlement focused on pearl fishing to a dynamic international city with outward reach and global impact, Doha's urban fabric has developed in important directions. The authors have studied the design and planning of Doha with attention to key initiatives including Transit Oriented Developments and Comprehensive Park Networks (Furlan and Sinclair 2020). They have also examined more holistic strategies for design and planning (Sinclair 2009, 2015). While initial efforts in Doha to bring landscape architecture into the equation were in support of major architectural icons (e.g., I.M. Pei's Museum of Islamic Art) and urban phenomena (e.g., The Corniche), over time the city has created numerous less prominent and less tourist-oriented parks that serve local neighbourhoods while together comprising an emergent and deliberate network. In this way, the authors refer to a 'string of pearls' -- moments of beauty organized and unified together along

a linear strand. Such networks have manifold benefits, including heightened urban connectivity, promotion of biodiversity, provision of recreational amenity and the promotion of greater sustainability. While a number of decades ago concepts of tactical or sustainable urbanism proved foreign concepts, today we see Islamic cities such as Doha reforming city planning and evolving urban design to foster more a walkable, liveable, healthy, and green milieu. Doha's commitment to exploring and realizing a comprehensive and integrated green network speaks to an awakening around the demonstrable benefits of a well-designed environment to public health and community vibrancy. The authors contend that the promise of Doha, and lessons learned along its path of progression as a greener city, offer direction to other Islamic cities facing many challenges in an ever-changing and rapidly evolving world. The present research develops a conceptual framework that considers the resonance of architecture, landscape and urban design in city planning, and advances initial guidelines for providing park networks that proffer greater amenity, heighten environmental responsibility and improve quality of life. The authors posit that the contemporary Islamic city, in an era of climate change and health challenges, needs to migrate the natural beauty of the private interior courtyard into the public landscaped park. In doing so, careful thought and great sensitivity must be afforded to the unique characteristics inherent to culture, context, people, and place.

## 2.0 TRACING THE HISTORY OF THE ISLAMIC GARDEN

Parks are synonymous to paradise. In the Islamic architectural conception, gardens embrace and signify polarities -- they link to beauty and practicality; to calming spirituality and hardworking agriculture; to the divine promises of abundance and the challenging scarcity of the resources. Much has been written about the history and the theology of the Islamic garden, its regional evolution, formal representation, techniques and sustainability (Ruggles 2008; Jani et al. 2015; Malins 1979; Asif et al. 2015). Beyond landscape architecture, Islamic gardens receive critical analysis pointing to the importance of archaeological reference in identifying the characteristics of gardens and to the influence of the regional intersections that lead to the Islamic garden's conceptual formation.

In this regards, Ruggles (2008) differentiates between the architectural and the environmental model of the Islamic garden. The first concerns the artistic quality and meaning, while the latter focuses on the garden as a functional system. Thus, the author attempts to merge the two approaches considering the nature, design and history of Islamic gardens and landscapes. Throughout his book, he questions the poetic representations of Islamic gardens in divine sources, literature, poems, and paintings against the imperatives of landscape architecture such as regional differences, climatic variations, and the recreation potential of the easily withering soft scape. Ruggles concludes his analysis by confirming the unifying characteristics of Islamic gardens as enclosure, quadrilateral design, and the prominence of water as a central element of the landscape.

Until the 20th century, there were few practical studies on the history and the form of the Islamic garden in the established western literature. Petruccioli (1998) acknowledges the early research efforts of C.M. Villiers-Stuart (English writer and painter) and the Baroness M.L. Gothein (Prussian scholar and gardener). Their contributions are valuable for restoration purposes, illustrating efforts to revive the original features of selected Islamic gardens such as Moghul and Indian gardens. In his article, Petruccioli rethinks the Islamic garden in terms of its form, structure and meaning. He further questions the conception of the "Islamic garden" in favour of the "gardens of the Islamic world", as a respondent to the geographical variance between Arabs, Persians, Turks, and others (Table 1).

**Table 1:** Garden Archetypes of Pre-Islamic Roots based on Concepts of Nature and Space. Source (Petruccioli 1998)

The Gardens of the Islamic World			
<i>Arab Garden</i>	<i>Persian Garden</i>	<i>Turkish Garden</i>	<i>Other Gardens (Indian)</i>
Garden as paradise; deserted sand as hell	Drawing earth and cosmos together	High plains and wide-open spaces of the prairies	Sense of time depends on agricultural seasons
Protective living space with high walls, solitary and sensual pleasure	Sophisticated and passive space	A resting spot	Symbiosis with nature
Introverted patio-house around a central garden	Biaxial symmetry and geometrical order	Hall between two gardens, open toward them on both sides	
Distinction and separation between the irrigated and the arid	A place for contemplation	A place for exploration rather than contemplation	

Furthermore, Petruccioli examines the garden as a constituent of the city form and in relation to (i) power, (ii) encampment, (iii) urban design and (iv) territory. In terms of (i) power, the governance of Islamic processes considers culture, religious imagery, hierarchy and the power of the king. The author sheds light on the themes of the royal city where gardens exist in the palace and in the city. Palaces conceive their layouts as gardens based on a structural grid system. Similarly, (ii) encampment relates to the mass mobility of the court where the garden is the most suitable landscape for campground and large-scale gatherings.

(iii) The relationship between the garden and urban design is a direct one. Gardens regenerate the Islamic city through creating room for greenery to appear as a dominant urban form. In fact, green belts cover vast areas between the center of the city and its bordering walls, recalling the recent approach in urban planning and design toward green urbanism that fosters the creation of green corridors and belts in a city-scale (Yokohari et al. 2000; Bae 1998; Rudel 2019; Bengston and Youn 2006). (iv) Likewise, gardens define territories and mark special features of the topography and culture. Illustrative examples are the gardens of Kashmir, Persia, and Central Asia. Thus, the main design elements of Islamic gardens, according to Petruccioli, are the symmetry, the simplicity and the metaphor of the garden in relation to the palace, encampment, territory and the city as a whole.

Perhaps the explanation of the Islamic garden in terms of territorial influences directly relate to the expression of this paper, namely the metaphorical string of parks. For instance, the statement below refers to the creation of a garden unity in Kashmir:

The 170 x 60 km valley of Kashmir becomes a single "garden," one of eternal flourishing beauty; then, it suddenly becomes one with the strong, opposite imagery of the safe haven, merging a vast valley and the architecture of a royal palace into a whole—a seemingly all-inclusive organic system (Petruccioli 1998).

The mission for unity and singularity of gardens and green landscapes is a major lesson learned from the history of the Islamic garden. Rather than isolated and disconnected constructions, the Islamic landscape historically acknowledged gardens as vital and intrinsic components of buildings and the city -- as part of a more systemic conceptualization that proved physical, cultural and spiritual. Such interpretation supports the aim of contemporary Doha in creating a string, or comprehensive network, of parks and gardens that combine beauty with functionality in an inclusive scheme.

### **3.0 FROM STRING OF PEARLS IN DOHA, QATAR**

It is the early 20th century. Pearl trade is the hydrocarbons of the time, where regional economy is prominently dependent on fishing and trading with pearls (Adham 2008; Khalaf 2006). Robert Carter (2005) records the history and the prehistory of pearling in the Gulf water that mediates between the Arabian Peninsula and Persia. He refers to the observations and the collected data of the British political resident and diplomat John Gordon Lorimer (Lorimer 1908).

A dense belt of pearl banks exists in close proximity to the Qatari northern sea (Figure 1, Figure 2). Meanwhile, in the period between 10th-16th centuries, the inland itself is rarely populated and in lack of fresh water supplies, shifting the pearling centres – as an industry – to other important nodal cities of the Gulf (Carter 2005). Later, the town of Zubarah in western Qatar arises as a new settlement based on the imperatives of the pearl industry and despite the limits of the climate and water scarcity (Richter, Wordsworth, and Walmsley 2011). The pearling market grows and keeps growing regionally, causing cities such as Doha in the eastern coast to urbanize and develop. Accordingly, Carter notes that the existence of the densest pearl banks overdrives the limitations of the local resources. Thus, the strategic location allows the city of Doha to flourish despite the lack of agricultural practice and its small demographic distribution (Carter 2005; Lorimer 1908).

Obviously, what follows the massive growth in the pearl market is a common sense and a universal role: Nothing stays on the peak forever. The great depression of the pearling industry as well as the series of the world wars transform the economy of the region, leaving traces and legacies for the upcoming generations.

A major lesson learned from this historical glimpse of the pearling industry is that the distribution and proximity of pearl banks provide a reference of thought to visualize the concept of 'string of pearls'. Pearl banks distribute based on natural features of the water and other geological formations (Richter, Wordsworth, and Walmsley 2011; Hughes 1997). They create a barrier, or a pearl belt, around the north eastern coasts of Qatar.

The question is: Can we use pearl banks as a natural creation with its various dynamics in the pearling history to recreate (or inspire the creation of) a model string of parks in the inlands? We expect the process to be in reverse, as we need to work with an existing socio-economical given to recreate a landscape model. Meanwhile, the string of pearls and pearl banks recreate the city (or actually create the city) physically, spatially and socio-culturally. Our endeavour is to create a comprehensive park network bearing in mind the previously discussed frameworks of the Islamic garden and the string of pearls. The metaphoric deployment of the pearling industry has meaning and purpose beyond nostalgia -- it celebrates a vital historical dimension of Qatar while concurrently providing a vehicle to connect otherwise disparate fragments pragmatically and responsively (that is, avoiding ecological islands). In doing so, we can reach a

well-articulated design narrative to rethink the green urbanism of the city, together with establishing a foundational reference to the history of urbanism in the region. A key aspect of our thinking, akin to the cord that brings the pearls together as a collective, is to ensure an interconnection of parks -- enhancing movement of people, promoting ecosystem continuity, mitigating the enduring climatic challenges and proving a predictable + contiguous amenity to the city.



**Figure 1:** Illustrative map of pearl banks in the Gulf region. Source: Victoria and Albert Museum, London (V&A Museum Closed Exhibition – Pearls 2014)



**Figure 2:** Guy & Brucks's map of northern Qatar of 1824 (Guy and Brucks 1824) cited by Carter (Carter 2019)

#### 4.0 TO STRING OF PARKS IN DOHA, QATAR

It is the year 2020. The autonomous governmental body that manages the entire construction of public projects and amenities, namely Ashghal Public Works Authority of Qatar, inaugurates a series of parks and plazas under its special commitment to beautify the country (ASHGHAL 2020). These recent efforts align with the National Development Framework 2032, QNDF 2032, aiming at implementing a strategic framework to guide metropolitan and regional built environmental developments, based on principles of sustainability and green urbanism (MME 2016).

The national framework, together with the efforts of various stakeholders and participants such as Ashghal, take the responsibility to address a major challenge in the green space management of Doha, collaboratively. The series of major public parks and local green spaces, as seen in the figure below (Figure 3) clearly lack connection and integration. Fragmentation of the system, and isolation of its constituent parts (i.e., parks), proves problematic on numerous levels. There is a preliminary effort in connecting parks in the West Bay area, linking the MIA Park with the Al Bidda and the Sheraton parks in a form of a crescent-shaped green corridor or belt. Yet, the inner-city parks and gardens in addition to the parks around the major football stadiums anticipates further integration and meaningful connection. The ultimate purpose, and hopefully the end goal, is to allow the public users to navigate through the comprehensive parks network in ease and comfort, while creating the proper foundation for urban design that fosters community creation and enhances sustainability. Not only that, but mitigating the climatic challenge is a primary objective of a comprehensive park network especially in an arid, hot city like Doha (Law and Underwood 2012). The development of these parks

must align with climatic design in terms of improving the macro and microclimates and response to the imperatives of the local environment. Green must incorporate with the existing hues of the sand and the sea to reproduce a place-specific scenario of the comprehensive park network that would resemble the true identity of Doha's urbanism. Grasping the unique characteristics of the city -- whether physical, social, or financial -- proves essential to realizing a park system that is meaningful, functional, responsible, symbolic, and sustainable.



**Figure 3:** Green Spaces and Parks in Doha, Qatar. Source (Furlan and Sinclair 2020)

Some scholarly work on green urbanism in the context of Doha address a possible solution to the fragmentation of parks and green landscapes: Green Corridors (Briffett et al. 2004; Groome 1990). These urban systems focus on the revival of the wildlife (or greenery) in the city-scale utilizing the existing urban morphology. Accordingly, green corridors incorporate greenery and parks through, for instance, converting the spaces around major arterial ways and roads into connecting green areas or urban hubs. Such spaces could incorporate street landscape, climatic moderation techniques (such as reducing heat islands in an intensely unforgiving climate) and intermediate parks and plazas, crossing the rigid boundaries of setback regulations without compromising for the safety and the security of the street users. The illustration below (Figure 4) proposes a green corridor in Doha designed on the basis of connectivity and accessibility (AL-Harami 2019). The proposal incorporates pedestrian and cycling access, pedestrian activities and facilities while prioritizing productive landscapes and native agricultural practice. These green corridors connect and merge at the differing green spots and individual parks, creating a park network, or system, that resembles a string. Such green corridors could become green belts in the wider city regions, running across the major arterial rings of Doha.



**Figure 4:** A green corridor proposal in Doha, Qatar. Source (AL-Harami 2019)



## 5.0 HOLISM, DESIGN + PLANNING

*“Through a growing capacity to tolerate uncertainty, vagueness, lack of definition and precisions, momentary illogic and open-endedness, one gradually learns the skill of cooperating with one’s work, and allowing the work to make its suggestions and take its own unexpected turns and moves.”*  
Juhani Pallasmaa (2009)

As the challenge of crafting integrated landscapes, and indeed pursuing far more integrated city planning, looms large, it is strategic to challenge the status quo. In conventional design and planning approaches there are tendencies to be deterred by the status quo and trapped in traditional ways of operating. However, the situation today is not ‘normal’ -- rather it is replete with change, upheaval, and uncertainty. The authors believe that challenging ‘business as normal’ is key to developing more appropriate, resilient and sustainable projects in Qatar and the Gulf Region. Design, as a powerful vehicle to address environmental problems and to advance and innovate the city, needs new ways to seeing, thinking, and acting.

A model to consider, as a more integrated city is contemplated and crafted, was developed by Sinclair (Sinclair 2015). The Holistic Model for Design and Planning (Figure 5) looks beyond separation and fragmentation, instead advancing methods that unite areas of Agility, Fitness, Diversity and Delight. Unlike more conservative environmental rating systems, this approach challenges designers and planners to critically consider projects, whether architectural, urban or landscape in extent, in deeper and more comprehensive ways. Bridging quantitative and qualitative perspectives, the model calls for environmental designers, politicians and other players to interrogate problems in new ways in an effort to invoke a broader spectrum of considerations when developing culturally suitable, socially vibrant and environmentally sustainable projects.



**Figure 5:** Sinclair Holistic Framework for Design + Planning. Source (Sinclair 2009, 20015; 1)

Our proposition for addressing the significant challenges of realizing more a resilient, vibrant and sustainable park network, is to deploy new models for designing while concurrently pursuing the concept of a ‘string of parks’, a system of ecological, social, cultural, recreational and sustainable landscapes that weave through the city, reinforce fragile ecologies and catalyse richer city life. Future research intends to test models, such as the Holistic Framework for Design + Planning, as vehicles for more tactical green urbanism in major urban centres in the Gulf Region, most notably in Doha, and beyond. There is little question, in the researchers’ minds, of the need to customize and otherwise tailor the urban and landscape design to the particular parameters of place. Sinclair’s framework, developed first for deployment in Mongolia, is intentionally resilient and responsive -- understanding that each country, context, climate, and culture requires careful attention when approaching design and planning. In the case of Doha Qatar, the

researchers argue that place matters and that any landscape master planning needs to accommodate a range of unique qualities. In the Sinclair frame all facets, including the core features of Fitness, Agility, Diversity and Delight, demand intense interrogation -- essentially and critically mapping facets of place against proposed design interventions. If an integrated system of parks (that is, a string of parks) is to find traction in Doha, the authors argue that its design must be carefully and systematically developed and tested with place (e.g., place-making, place-attachment, place-identity) front of mind.

## 6.0 SYNOPSIS AND NEXT STEPS

*Inextricably linked to each other and strongly guided within the Islamic tariqah (path), this lack of separation also provides an accommodating environment (uncommon to other monotheistic faiths) to embrace foreign concepts that allow for spiritual interpretation as well as meaning and progress of not just Muslims but all of humanity in an arguably more ethical manner. (Bin-Zayyad and Sinclair 2016)*

Our contemporary times underscore a highly intertwined and inter-related world, where aspects of global warming, pollution, rising water levels, resource depletion and other daunting challenges undeniably transcend local jurisdictions and national borders. Cities around the world are growing as the urban-rural balance tips in favour of urbanism. The loss of productive agricultural lands, and the deforestation witnessed around the planet, all give cause for worry and reasons for action. One viable solution to counter many of these crises pertains to the nature of the city and nature in the city. The present paper looks at the notable case of Doha Qatar, a city that has grown in population and prominence, while concurrently seeking innovations in city building that can position it as a leader on numerous counts. For the authors, the sphere of landscape presents rich potential for Doha to prove exemplary in advancing green space as fundamental to responsible city building.



**Figures 6 & 7:** Metaphorical String of Pearls + Conceptualized String of Parks

Looking at historical approaches to landscapes in the Islamic world, including interior courtyards and public gardens, the present research argues that Doha is well placed to develop a more comprehensive park network (a string of parks) that contributes to a better quality of life while serving in a regenerative capacity environmentally. Our strategy for approaching the development of such a contiguous landscape system considers the need for natural environments to be unbroken -- to prevent ecological islands and disconnected biomes. If nature benefits in the equation, the authors believe that so too do the city residents and visitors. Underscoring the need to balance the material world (duniya) with the spiritual world (din) in the Islamic world, bin Zayyed and Sinclair (2016) contend that both qualities should be pursued in concert in contemporary design -- of buildings, of landscapes and of cities. The idea of a 'string of parks', metaphorically and historically reminiscent of Qatar's rich pearling industry, seeks to marry beauty and function, natural environments with built environments, and people and place, in synergy and harmony (Figures 6). There are many dimensions of place that need to be meaningfully tackled when designing and planning, whether in Doha, in the Middle East, or beyond. Rather than seeking narrow prescribed solutions which are all too often imposed regardless of circumstances, the authors argue that key universal principles can be culled out and then applied in a customized manner to meet local needs, respect local culture, and respond to local conditions. This idea of needs, culture and conditions is rooted in a profound emphasis on place -- the idea of deploying the metaphor of a 'string of pearls' builds from deep rooted historical meaning while concurrently seeking ecosystem integrity. The present research is significant in its highlighting new ways of seeing, thinking, and acting amidst a milieu of rapid change and unprecedented crises (e.g., global climate change, heightened international political instability, the daunting disruption of a pandemic, etc.). As we consider novel ways to tackle sustainability, address climate change, honour culture, and heighten sustainability, it will prove increasingly critical to nuance solutions to circumstances. The present paper outlines one strategy for meeting global pressures while reacting to local forces. Qatar's future, and indeed that of the world beyond, depends on the pursuit of responsible, sensitive, and sustainable design and planning. A sustainable Doha will bring with it walkability, liveability, health, wellness, happiness, and a higher quality of life.

## REFERENCES

- Adham, K. 2008. Rediscovering the Island: Doha's Urbanity from Pearls to Spectacle. In *The Evolving Arab City: Tradition, Modernity and Urban Development*, edited by Y. Elsheshtawy. UK: Routledge.
- AL-Harami, A. 2019. The Sustainable Urban Edge Design Toolkit for Coastal Cities, The Case of Doha, Qatar, Department of Architecture and Urban Planning, College of Engineering, Qatar University, QSpace.
- ASHGHAL. 2021. *The Supervisory Committee of Beautification of Roads and Public Places in Qatar*. [www.ashghal.gov.qa](http://www.ashghal.gov.qa) 2020 [cited 5-January 2021]. Available from <http://www.ashghal.gov.qa/en/Projects/Pages/Beautification-of-Roads-and-Public-Places.aspx>.
- Asif, N., N. Utaberta, M. A. Othuman Mydin, and M. Y. Mohd Yunus. 2015. Redefining Islamic Garden: Comparative Analysis of Approaches, Ideas and Design Framework. *UTM Jurnal Teknologi* 75 (9).
- Bae, C.-H.C. 1998. Korea's Greenbelts: Impacts and Options for Change. *Pacific Rim Law Policy Assoc. J.* 7:479–502.
- Bengston, D. N., and Y-C. Youn. 2006. Urban Containment Policies and the Protection of Natural Areas: The Case of Seoul's Greenbelt *Ecology and Society* 11 (3).
- Bin-Zayyad, S, and B Sinclair. 2016. Culture, Context + Environmental Design: Reconsidering Vernacular in Modern Islamic Urbanism. Paper read at Architectural Research Addressing Societal Challenges. International Research Conference: Architectural Research Centres (ARCC) / European Association of Architectural Educators (EAAE), at University of Lisbon, Portugal.
- Briffett, C., N. Sodhi, B. Yuen, and L. Kong. 2004. Green Corridors and the Quality of Urban Life in Singapore. Paper read at the 4th International Urban Wildlife Symposium, at School of Natural Resources and the Environment, AZ, USA.
- Carter, R. 2005. The History and Prehistory of Pearling in the Persian Gulf. *Journal of the Economic and Social History of the Orient (JESHO)* 48 (2):139-209.
- . 2019. Pearl Fishing, Migration, and Globalization in the Persian Gulf, Eighteenth to Twentieth Centuries. In *Pearls, People and Power: Pearling and Indian Ocean Worlds*, edited by P. Machado, S. Mullins and J. Christensen. Athens, Ohio: Ohio University Press.
- Furlan, R., and B Sinclair. 2021. Planning for a Neighbourhood and City-Scale Green-Network System in Qatar: The Case of MIA Park. *Environment, Development and Sustainability (ENVI)*. DIO: 10.1007/s10668-021-01280-9.
- Groome, D. 1990. "Green corridors": A Discussion of a Planning Concept. *Landscape Urban Planning* 19:383-387.
- Guy, L. J. M., and G. B. Brucks. 1824. Trigonometrical Survey of the Arabian or Southern Side of the Persian Gulf by Lieutenants J. M. Guy & G. B. Brucks H.C. Marine. London British Library Map Collections.
- Hughes, G. W. 1997. The Great Pearl Bank Barrier of the Arabian Gulf as a Possible Shu'aiba Analogue. *GeoArabia* 2.
- Jani, H. H., N. Z. Harun, M. Mansor, and I. Zen. 2015. Exploring the Islamic Garden Concept as Inspirational Landscape Design. *Procedia - Social and Behavioral Sciences* 170:359-368.
- Khalaf, S. 2006. The Evolution of the Gulf City Type, Oil, and Globalization. In *Globalization and the Gulf* edited by J. Fox, N. Sabbah and M. ALMutawa. London: Routledge.
- Law, Rosanna, and Kevin Underwood. 2012. Msheireb Heart of Doha: An Alternative Approach to Urbanism in the Gulf Region. *International Journal of Islamic Architecture* 1 (1):131-147.
- Lorimer, J. G. 1908. *Gazetteer of the Persian Gulf, Oman and Central Arabia*. Vol. 2: Calcutta.
- Malins, E. 1979. Reviewed Work: The History of Gardens by Christopher Thacker. *Garden History* 7 (2):20-21.
- MME. 2016. Qatar National Development Framework (QNDF-2032). Doha, Qatar: Ministry of Municipality and Environment.
- Pallasmaa, Juhani. 2009. *The Thinking Hand: Existential + Embodied Wisdom in Architecture*. W. Sussex UK: Wiley.
- Petruccioli, A. 1998. Rethinking the Islamic Garden. In *Transformations of Middle Eastern Natural Environments: Legacies and Lessons*, edited by J. Albert, M. Bernhardsson and R. Kenna. New Haven, Connecticut: Yale School of Forestry & Environmental Studies Bulletin Series.
- Richter, T., P. Wordsworth, and A. Walmsley. 2011. Pearl Fishers, Townsfolk, Bedouin, and Shaykhs: Economic and Social Relations in Islamic al-Zubārah. Paper read at The Seminar for Arabian Studies, at British Museum, London.
- Rudel, T. K. 2019. England: Green Belts After World War II. In *Shocks, States, and Sustainability: The Origins of Radical Environmental Reforms* edited by T. K. Rudel: Oxford University Press.
- Ruggles, D. F. 2008. *Islamic Gardens and Landscapes*. Pennsylvania: University of Pennsylvania Press.
- Sinclair, B. R. 2009. Culture, Context, and the Pursuit of Sustainability (Cover Article). *Planning for Higher Education (PHE) Journal* (38):6-22.
- . 2015. Integration | Innovation | Inclusion: Values, Variables and the Design of Human Environments. *Cybernetics and Systems: An International Journal* 46 (6-7):554-579.
- V&A Museum Closed Exhibition – Pearls. 2014. London Victoria and Albert Museum.
- Yokohari, M., K. Takeuchi, T. Watanabe, and S. Yokota. 2000. Beyond Greenbelts and Zoning: A New Planning Concept for the Environment of Asian Mega-Cities. *Landscape Urban Planning* 47:159-171.

# Performance as Action. The Embodied Mind

Loukia Tsafoulia<sup>1,3</sup>, Severino Alfonso<sup>1,2</sup>,

<sup>1</sup> Thomas Jefferson University, Philadelphia, Pennsylvania

<sup>2</sup> Universidad Politecnica de Madrid, Madrid, Spain

<sup>3</sup> National Technical University of Athens, Athens, Greece

**ABSTRACT:** The paper addresses the concept of performance via a historical investigation of the dynamics observed between design and science through the lenses of cybernetic theories. It proposes a transdisciplinary and historical inquiry on the human-machine-environment recursive relationships. The paper maps parallel events relating design and cybernetic works and constructs a brief historical lineage of scientific approaches to design as they were manifested within design education in the US starting prior to WWII with a focus on the *behavioral* turn of the 1950s. The *design methods* movement which stemmed from the scientific and technological optimism of the postwar era looked at the design disciplines through rational scientific foundations. During the 1970s, philosophical and phenomenological critiques of these approaches would forcefully appear. The following generations of the *design methods* movement and the *design thinking* approach would “double the vector” and see science as a specific form of design inquiry; rather than apply science to design, science could be understood as a form of design activity, reversing the more usual hierarchy between the two.

From the 1940s-1960s cybernetic electromechanical “perception” devices set in demystifying the human brain to the *design methods* movement in architecture and its mutations, the paper traces connections between traditionally disparate fields and reveals operations, tactics, and methods that situate the notions of performance and adaptation. The paper argues for a dialectical approach to the contemporary understandings of performance as it was manifested in psychologist and cybernetician Ross Ashby’s “embodied mind” concept in the 1960s. Via the construction of parallel historical lineages, the paper reflects a willingness to transcend disciplinary boundaries that is characteristic of cybernetics’ origins cutting across distinctions between design and science fields as well as those between objectivity and subjectivity, human and machine, and mind and body.

**KEYWORDS:** design methods movement, cybernetic theories, design thinking, embodied mind, adaptive systems

## INTRODUCTION

The paper constructs a parallel historiography of events that trace the evolution of the *design methods movement* from the 1960s to the 1980s and that of the early cybernetic theories from the 1950s to the second-order cybernetics of the 1970s. Via unfolding the dynamics observed between scientific methods and design processes, the paper reveals a continuous evolution towards softening harsh dichotomies as proclaimed in the beginnings of each of these parallel theories and practices. These dichotomies refer to early rational approaches that tried to set a base for studying complex systems -from the human body to society- via splitting the body and the mind, the biological brain and the self, and via creating harsh distinctions between reason and subjectivity, sense and sensibility, representation and action, embodied and abstracted cognition.

We make two observations, first the importance of *doubling the arrow* in the process of importing and exporting flows of knowledge and methods between sciences and design. Second, we argue that the hot debates and intermediate “splits” occurring from the 1950s to the 1980s both in scientific fields —focusing on cybernetic works on adaptation and performance— and the design fields —focusing on the *design methods* movement in architecture— eventually empowered their original scope and hence new paths moving forward were engendered. Looking back at these dynamics can shed a light on contemporary understandings of the various, open-ended, and encompassing concepts of performance, and indicate dialectical paths for future operations.

## 1.0 CYBERNETICS: A GENERAL SCIENCE

Cybernetics appeared in the early 40s and was vividly explored in the 1960s-1970s to later dissolve into other fields of knowledge thus submitting to its original multidisciplinary weight. English psychiatrist and a pioneer in cybernetics Ross Ashby articulated the power of cybernetics as a general science concerned with complex systems — the machine, the brain, the society — and provided a bridging language for the collaboration of various, diverse fields:

Here I need only mention the fact that cybernetics is likely to reveal a great number of interesting and suggestive parallelisms between machine and brain and society. And it can provide the common language by which discoveries in one branch can readily be made use of in the others. the similarities between a servo-mechanism and a cerebellar reflex. Cybernetics offers one set of concepts that, by having exact correspondences with each branch of science, can thereby bring them into exact relation with one other (Ashby 1956, 4).

Hugh Dubberly and Paul Pangaro refer to cybernetics as: “at once everywhere and nowhere, a science with no home of its own” (Hubberly, Pangaro, 2015). Sociologist Andrew Pickering offers a reading of “cybernetics as a nomad science, perpetually wandering and never finding a stable home”:

For readers of Gilles Deleuze and Félix Guattari’s *A Thousand Plateaus* (1987), the phrase “nomad science” has a special resonance in its contrast with “royal science.” The royal sciences are the modern sciences, which function as part of a stable social and political order—which prop up the state. The nomad sciences, on Deleuze and Guattari’s reading, are a different kind of science, one which wanders in from the steppes to undermine stability (Pickering 2010,11 ).

With Ashby’s first book, *Design for a Brain* (1952), neurophysiologist and cybernetician Grey Walter’s *The Living Brain* (1953) and, later in 1972, theorist Stafford Beer’s, *Brain of the Firm*, it is made clear the multivalent directions these ideas took and the ecumenic influence cyberneticians had upon other fields of knowledge. Pickering provides a series of intertwined stories:

Ashby’s first book, *Design for a Brain* (1952) was all about building synthetic brains, but Christopher Alexander made it the basis for his first book on architecture, *Notes on the Synthesis of Form* (1964). A quick glance at *Naked Lunch* (1959) reveals that William Burroughs was an attentive reader of *The Living Brain*, but Burroughs took cybernetics in directions that would have occurred to no one else. found an active readership diverse enough to span protoroboticists and the Beat writers and artists. It was a turning point in his musical career when Brian Eno’s mother-in-law lent him a copy of Stafford Beer’s book, *Brain of the Firm*, in 1974 (Pickering 2010,11).

Today, the origins of those ideas are largely forgotten, but even though dormant, they continue to invisibly feed discourses about the nature of knowledge, representation and cognition, artificial intelligence and situated robotics, smart architectures, datalands, and sentient spaces, and about how we interact with computing machines and how we design for interaction. A historical overview may help us understand better where we are, how we got here, and where we might go, it offers models for future practice and forms of life.

## 2.0 TOWARDS A BEHAVIOURAL TURN

With the rise of World War II and accelerating through it and thereafter, a number of scientists designed sophisticated mechanical and electrical systems that had the capacity to perform actions through adaptation. Cyberneticians put theories to practice by building electromechanical devices that were themselves adaptive and which could thus be understood as perspicuous and suggestive models for understanding the brain itself.

Even though in popular view cybernetics emerged by the intersection of engineering and mathematics, and linked with military applications, an important branch of cybernetics stems from the work done by scientists researching the human brain and how it performs, often in the psychiatric domain. This is the story of cybernetics that the historian of science Andrew Pickering, and philosopher of science Peter Asaro, amongst others, have narrated. What emerged was a new way of looking at systems, not just mechanical and electrical systems, but also biological and social systems: a unifying theory of systems and their relation to their environment (Dubberly, Pangaro, 2015). One can view cybernetics as a way of framing the world via systems; as an alternative way of thinking and therefore being. Pickering in his book *The Cybernetic Brain* (2010) goes as far as shaping a philosophical argument of cybernetic ontology.

In the first chapter of his *An introduction to cybernetics* book, first published in 1956, Ashby refers to the *peculiarities of cybernetics* and puts emphasis to the concepts of action and behavior as he parallels cybernetics with a “Theory of Machines”:

Cybernetics, too, is a “theory of machines”, but it treats, not things but ways of behaving. It does not ask “what is this thing?” but “what does it do?” Thus it is very interested in such a statement as “this variable is undergoing a simple harmonic oscillation”, and is much less concerned with whether the variable is the position of a point on a wheel, or a potential in an electric circuit. It is thus essentially functional and behaviouristic.” (Ashby 1956,1)

Ashby’s notion of *behavior* has gained a protagonist role in the field of design and its various concentrations both in the realms of education and practice. The focus on behavior, rationality and systematization gave rise to the *environmental design* and *design methods* movements in the 1950s-60s, and its evolutionary mutations of *design thinking* from the 1970s on.



### 3.0 ACADEMIA'S ROLE IN THE SCIENTIFICATION OF DESIGN AND THE BEHAVIOURAL TURN

Two important manifestations in design deriving from cybernetics are, a push towards research and process-based design claiming scientific rigor, and an opening of the design fields to multidisciplinary horizons. These manifestations became apparent in the context of pedagogical and academic practices, thus marking a period that embodies the design fields' porosity towards a wide range of forces. Most notably, the fluctuating character of architecture education, or as Joan Ockman refers to, its syncretic nature (Ockman, 2012) is set under the auspices of the Beaux-Arts versus the Polytechnic models, both originating in Europe by the middle of the 19th century. These educational systems are rooted in the fine arts' diffusion of a liberal, humanistic culture on the one hand, and the "pure" scientific research on the other. The creation of a research agenda is a consequence of the implementation of the polytechnic model in architecture education, but this process has often been received with skepticism by historians and the professional realm alike. In his 1985 Walter Gropius Lecture at Harvard, Henry Cobb, then chair of the architecture department at Harvard's Graduate School of Design for example, proclaimed the incompatible cultures of academic research and creative practice (Cobb, 1986).

The discipline of architecture is historically situated between dipoles such as design versus science and architecture education versus its practice. A brief lineage of architectural education focusing on the integration of research in architecture schools in North America serves as a way to situate the above-mentioned dynamics within a historical context.

In the context of the United States, prior to the 1920s, little research conducted by faculty and students in architecture schools can be described as scientific<sup>1</sup>. It was not until the 1930s that a number of laboratories for teaching design came into being, mainly influenced by the workshop-based education pioneered at the Bauhaus.<sup>2</sup> The transition to the 1950s is a period of heated academic debates regarding the insertion of art and the Beaux-Arts educational model into the dominating model at the time, proposed by the Bauhaus and its followers. This was evident in the works by Siegfried Giedion with his "new humanism", by C.P. Snow's 1959, *The Two Cultures*, and by Walter A. Taylor's 1959 article *A School of Architecture of the Future* where they made evident the widening divide between the "two cultures" — humanities and science—.

From the 1950-on the turn to a new "behavioral approach" emulated the type of social-scientific and statistical research. Instigated largely by government agencies such as the National Institute of Health, these new directions quickly became known as *environmental design* and *design methods* research. At the Ulm School of Design (HfG) in postwar Germany, where mathematician Nobert Wiener lectured in 1955, *environmental design* appeared as a holistic design approach. At the University of Michigan in 1958 a large-scale group research project aimed at studying the interplay between human behavior and the environment, with participants from numerous departments (Moran, 2012). In 1963 the University of California in Berkeley transformed its Beaux-Arts School of Architecture into a *school of environmental design*. As part of the transformation, dean William Wurster hired two of the founders of the *design methods* movement; Horst Rittel from Ulm where he had been Professor of Design Methodology was appointed Professor of the Science of Design as well as Christopher Alexander (Dubberly, Pangaro, 2015).

Whereas *environmental design* focused on analysis of the particular effects of the built environment from the scale of individual rooms to institutional complexes-induced in its users, the *design methods* movement concentrated on the parameters involved in design problems, exploring how through processes of systematization, the design of such spaces could be made more rational. This brought methodologies associated with psychology, psychiatry, human geography, and urban ecology into the purview of architecture education (Moran, 2012). During this period, the architecture's discourse interest in linguistic, behavioral, computational, communicational, cybernetic diagrams reveals the techno-social tendency as a response to aesthetic formalism. A problem-solving and relevance-seeking mentality transformed the very sense of the discipline (Dutta, 2013). As Avigail Sachs elaborated, with these interdisciplinary research initiatives of the 1950s, the term research changed in meaning, more than just implying a set of accepted practices, it embodied the aspiration to put architecture education on a firm scientific basis (Sachs, 2009).

### 4.0 THE DESIGN METHODS MOVEMENT

In 1962, both psychologist and cybernetician Gordon Pask and architect Christopher Alexander attended the first *design methods* conference at the Imperial College in London, organized by industrial designer Christopher Jones and mechanical engineer Bruce Archer, along with a group of similarly minded designers and engineers.<sup>3</sup> This was the inaugural event in a series that was grouped under what came to be the *design methods* movement.

At that time, Pask also had a visiting position at the Architecture Association in London, where he collaborated with architect Cedric Price and director Joan Littlewood on the seminal *Fun Palace*, an architecture work-epitome in integrating concepts of adaptation, conversation and performance. Soon after in 1969, Pask would publish *The Architectural Relevance of Cybernetics*, explicitly framing design as cybernetics. This article, together with his earlier musicolour — a performative human-machine assemblage—, his training machines, and his conversation theory — developed in parallel to Ashby's and Walter's works— paved the way for a series of future projects connecting cybernetic theories and design.



The introduction of Christopher Alexander's work *Notes on the Synthesis of Form* in 1964 was a call for logic and rationality in confronting head on the complex problems of the built environment.

The use of logical structures to represent design problems has an important consequence. It brings with it the loss of innocence. A logical picture is easier to criticize than a vague picture since the assumptions it is based on, are brought out into the open. Its increased precision gives us the chance to sharpen our conception of what the design process involves. But once what we do intuitively can be described and compared with non-intuitive ways of doing the same things, we cannot go on accepting the intuitive model innocently. Whether we decide to stand for or against pure intuition as a method, we must do so for reasons which can be discussed (Alexander 1964, 8).

Alexander proposes process-based, systematic methods as a "replacement to intuitive ad-hocism and a means to magnify the designers' cognitive and creative capabilities" (Alexander 1964, 11). With its systems-based approach, cybernetics integrated process and relationships, pushing design beyond its object-based approach. This context highlights architecture and design education's practice of absorbing methods, theories, and discourses from its exterior. Analyzing particularly the period when the *design methods* approach is manifested, the effort to proclaim the porosity of the design fields becomes apparent. Archer's *Systematic Method for Designers* (1965) expressed a need to broaden the scope of conventional design:

Ways have had to be found to incorporate knowledge of ergonomics, cybernetics, marketing and management science into design thinking... The time is rapidly approaching when design decision making and management decision making techniques will have so much in common that the one will become no more than the extension of the other (Archer, 1967).

## 5.0 DOUBLING THE ARROW

During the same period there was also an imperative to decipher the flows of knowledge in design fields not only as a receptor discipline, but also those occurring from the discipline outwards. Developing creativity techniques in the 1950s and new design methods in the 1960s led to the idea of design thinking as a particular approach to solving problems via creativity. From the early 1970s onwards, more works would see science as a specific form of design inquiry; rather than apply science to design, science could be understood as a form of design activity, reversing the more usual hierarchy between the two.

Ideas of design as a "way of thinking" in the sciences are articulated in the 1969 book *The Sciences of the Artificial* by political scientist and cognitive psychologist Herbert A. Simon where he develops a theory of human problem solving. For Simon, problem solving is design, tinkering with artifacts; one could say that his book is therefore a meta-design theory (Vandenbroeck, 2020). And in cybernetic tradition, Simon confronts a large number of disciplines, including organizational decision-making, economics, human cognition and artificial intelligence. The 1982 article *Designerly Ways of Knowing* by design researcher and professor at The Open University Nigel Cross, established some of the intrinsic qualities and abilities of design thinking that also made it relevant in general education and thus for wider audiences.

The 1980 Design Research Society's *Design:Science:Method* conference highlighted views that soften the earlier hard lines drawn between science and design by the design methods' folks of the early 1960s. As Nigel Cross (Cross, 1993) points out, the general feeling from that conference was that it was time to move on from making simplistic comparisons and distinctions between science and design; that perhaps there was not so much for design to learn from science after all, and that perhaps science rather had something to learn from design. As Archer (1981) wrote in his paper for that conference, "Design, like science, is a way of looking at the world and imposing structure upon it". Both science and design, as Glynn (1985) pointed out, are essentially based on acts of perception, and it is the epistemology of design that has inherited the task of developing the logic of creativity, hypothesis innovation or invention that has proved so elusive to the philosophers of science.

From the 1990s on, more informed views for science, design and their relation appear. The simple dichotomies expressed in the 1960s are being replaced by a more complex recognition of the web of interdependencies between knowledge, action and reflection (Cross, 1993). Levy's viewpoints in the 1980s make scientific methodology sound indistinguishable from design methodology:

Science is no longer perceived in terms of a single fixed methodology focused on a specific view of the world. It is more an expanded rationality for problem-identifying, -structuring and -solving activities.' (Levy, 1985)

## 6.0 CRITIQUE OF REASON IN THE DESIGN METHODS MOVEMENT

Pushed by an aim towards a more complex web of design principles, a series of debates that were grounded on philosophical, psychological and existential milieus forcefully countered the rationality of the design methods movement. These objections —coming from a cast of philosophers on ethics as well as psychologists— articulated concerns on the disembodied, reductive and abstracted approaches of the movement. Questions such as how people make sense of the environment? design for whom? What about human experience and perception? were critically

posed against the design methods behaviorism and raised the importance of the user's agency and of design as an embodied experience. These debates were clearly articulated during the Portsmouth Symposium of 1967 on Design Methods in Architecture (Broadbent, Ward, 1969), which was the movement's third convention, five years after its inauguration.

To put all the arguments into context it is necessary to recall the social and cultural climate of the late 1960s, the campus revolutions, the new liberal humanism and the rejection of previous values. Cybernetics is simultaneously contributing to the rise of the *design methods* movement while also connecting with the 1960's counterculture. In 1968, Stewart Brand founded the Whole Earth Catalog, a publication that during the 1970s exploded in popularity, becoming a cultural phenomenon. Brand's goals were to make a variety of tools accessible to counterculture communities, DIY advocates and innovators in the fields of technology and architecture. The Whole Earth Catalog is also an introduction to systems thinking and includes reviews of a combination of design and scientific works by Ross Ashby, neurophysiologist Warren McCulloch, architect Nicholas Negroponte, mathematician Gyorgy Polya, and many more. The first section of the catalogue is titled *Understanding Whole Systems*. This section emphasizes Buckminster Fuller's *comprehensive designer*, "an emerging synthesis of artist, inventor, mechanic, objective economist and evolutionary strategist." (Fuller, 1969)

The late 1960s marked a turn to the social sciences in design academia. In 1967, the results of the AIA Educational Research Project known as the *Princeton Report*, co-authored by Robert L. Geddes, dean of Princeton's architecture school, and Bernard P. Spring were published. One year after the Princeton Report appeared, its recommendations seemed to be put to practice by Denise J Scott Brown, Steven Izenour, and Robert Venturi in their famous *Learning from Las Vegas* studio at Yale. Conducted over four days in Los Angeles and a week and a half in Las Vegas, the studio focused on in-depth fieldwork, namely the documentation of highway strip architecture. By the start of the 1970s in numerous divisions, the earlier behavioral turn was succeeded by a cultural one. In 1976, this cultural direction was clearly institutionalized with the initiation of a Ph.D. program in History, Theory and criticism of Art and Architecture at M.I.T., epitomizing the rise of critical theory and history within architectural schools and emphasizing architecture's embeddedness in society (Moran, 2012).

A decade after its birth, the 1970s became also notable for the rejection of design methodology by its early pioneers. Christopher Alexander said:

There is so little in what is called "design methods" that has anything useful to say about how to design buildings that I never even read the literature anymore ... I would say forget it, forget the whole thing ... If you call it "It's A Good Idea To Do", I like it very much; if you call it "A Method", I like it but I'm beginning to get turned off; if you call it "A Methodology", I just don't want to talk about it (Alexander, 1971).

And J. Christopher Jones said:

In the 1970s I reacted against design methods. I dislike the machine language, the behaviourism, the continual attempt to fix the whole of life into a logical framework (Jones, 1977).

While tracing the evolution of the *design methods movement* it is also helpful to address Rittel's theory of generations. As N. Cross (Cross, 1993) analyses:

The first generation (of the 1960s) was based on the application of systematic, rational, 'scientific' methods. The second generation (of the early 1970s) moved away from attempts to optimize and from the omnipotence of the designer (especially for 'wicked problems'), towards recognition of satisfactory or appropriate solution-types (Simon (1969) had introduced the notion of 'satisficing') and an 'argumentative', participatory process in which designers are partners with the problem 'owners' (clients, customers, users, the community). Perhaps a third generation of the 1990s might be based on a combination of the previous two; or, as in the model proposed by Cross (1989), on understanding the 'commutative' (Archer, 1979) nature of problem and solution in design.

The behaviorism and rationality critiques of the design methods' first-generation movement eventually enriched future design premises, such as the human centric design approaches of the 80s and served as a proof of need to move towards dialectical and synthetic approaches between rationality and human experience.

## 7.0 The *embodied mind* in the body - mind dualism

To understand the above-mentioned objections, is important to step back in time and scope. Controversies regarding issues of human cognition and perception, in both cybernetics and design, converged with the mind-body problem debate and as such can be broken down to its ontological and causal questions. The debate arises for different aspects of the "mental" such as consciousness, intentionality, and the self, but also for aspects of the "physical" such as the problem of embodiment (Robinson, 2020). The mind-body problem can be framed as another fluctuating ontological dipole; on the one hand, stands a physical understanding of the relationship —*computationalism* is here included—, and on the other, a dualist view which states that the mental and the physical are both real and neither can be assimilated to the other —*enactivism* belongs to this line of thought. The *computationalist* theories of the mind, like the

physicalist, hold that the human mind is an information processing system and that cognition and consciousness together are a form of computation. On the other hand, *enactivism*, a theory influenced by Ashby's work, argues that cognition arises through a dynamic interaction between an acting organism and its environment (Thompson, 2010).

The dualist understanding of the mind-body problem has been out of fashion in psychology since the 1950s. One could argue that cybernetics had a rebooting effect on these conversations as they looked into the ontology and nature of the mind and its relationship with the body as central to their work. Cybernetics "dictated" a new conceptual framework given the new technological and philosophical dynamics of the time. Notably, Ashby's homeostat<sup>4</sup> manifested the concept of embodied mind as it defines the structure of embodied representation equally in terms of perception and action where the role of perception is largely to modulate and regulate action. In Asaro's words:

the concept redistributes the relative weights placed upon perception and motor controls, stepping away from the traditional theories of mind, usually built upon passive observers and not requiring actors. That is also to say that the sensory and the motor are both equally implicated in the feedback loops which regulate behaviour (Asaro, 2009, 115).

A connection with Ashby's embodied mind would come from American psychologist James J. Gibson's ecological theory of perception and his coined term 'affordances,' used to describe how the mind perceives the world in terms of the various activities it affords to the body (Gibson, 1966). To Gibson, perception is a compilation of the person's environment and how the person interacts with it, claiming that the environment decides perception, and that meaning is found in what the environment "affords" the observer. This way of understanding how individuals experience an environment related closely to the proclamations made by *enactivism*.

With the "split" of the cybernetic movement between *computationalism* and *enactivism* in the 1950s, the *computationalist* tradition that subsequently became dominant, and remained so for the next few decades, played down the importance of body, focusing primarily on abstract models of cognition (Aizawa, 2006, 236). Insofar this approach was able to describe general computational principles that might govern cognition it was relatively successful, but since the late 1980s embodied approaches have been making a resurgence, most significantly in embodied robotics and the various versions of *enactivism*. The overall timeline is revealing as to the design-science historical overlaps. The *design methods* movement was in a decade —1960s— when the physicalist theories of the mind dominated both the scientific and philosophical conversations, and it wasn't until the 1970s —or even 1980s— that the "dormant" body-mind dualism declared itself via the lens of action and environment.

Both theories draw on the cybernetic principles and ideas found in the works of Walter and Ashby, emphasizing in particular, the importance of the interaction between a system and its environment, and the emergence of cognition out of basic biological processes such as homeostasis (Dewhurst 2018.) Walter's and Ashby's early work of the 1950s looked at the biological brain and through their electromechanical machines —like the tortoise and the homeostat— they introduced the concept of *synthetic brains*. A second generation of scientists with cybernetic contributions such as the anthropologist Gregory Bateson and psychiatrist R. D. Laing, moved beyond the biological brain to focus on the self and its social relations, the social self. Stanford Beer's and Gordon Pask's work also followed and eventually moved beyond the work of Walter and Ashby in their pursuit of material models of the *adaptive brain*.

Beer's experiments with *Daphnia* and ponds and Pask's with electrochemical "threads" were precisely attempts to "grow" adaptive brains—nondigital and nonrepresentational, biological or quasi-biological computers. (Pickering 2010, 9).

The evolution of these works, from early conventional physiological approaches to studying the human brain as a complex system, to later, experimental, all-encompassing views including the self, all draw a parallelism to Rittel's theory of generations.

## CONCLUSION

Looking back at the early evolutionary cybernetic "perception" machines including Ashby's homeostat, Gray Walter's light seeking tortoises, and later on Gordon Pask's musicolor —all works deeply influential to the *design methods* movement proclaimers— a meaningful synergy between psychology, philosophy and scientific rigor is revealed and an understanding of performance as action —bodily, biologically and socially— is being promoted. These dialectical approaches, we argue, entailed softening the rational lenses of the first-generation *design methods* movement in its aspiration to systematize design and anticipate its social outcomes. Ross Ashby's work on the nature of embodied mind is key in framing the importance of the user and the body as a performative entity made of complex actions that define the space as much as the space defines the actions of the body.

In an attempt to make a parallelism between the transition from the first generation of cybernetics to the second order cybernetics and the evolution of the *design methods* movement to the later *design thinking* approaches, the paper argues that —in both the sciences and design realms— the reincorporation of the human and the coupling between reasoning, perception and embodiment enriched the original scope. In design's and cybernetics' parallel evolution and through their various mutations and entanglements, the synthesis between subjective interpretation and methodological rigor appeared as a very real possibility. As psychology, neuroscience, cognitive science and artificial intelligence evolve,

new paths are engendered. The *embodied mind* entails a performative understanding of the brain, mind and self, transgressing the familiar dualism of mind and matter. In embracing the “unknowns” of perception and intuition, while including the body, the *embodied mind* concept offers a valuable resource for the future of the design discipline.

## REFERENCES

- Aizawa, Kenneth. “Turing-equivalent computation at the “conception” of cognitive science.” In *The Routledge Handbook of the Computational Mind* Routledge, edited by Mark Sprevak and Matteo Colombo. London; New York: Routledge, 2019.
- Alexander, Christopher. 1964. *Notes on the Synthesis of Form*. Cambridge, MA: Harvard University Press.
- Alexander, Christopher. 1971. *The State of the Art in Design Methods*. DMG Newsletter 5(3): 3-7.
- Archer, L. Bruce. 1965. *Systematic Method for Designers*. London, The Design Council.
- Archer, L. Bruce. 1967. *Design Management*. Management Decision 1.4 : 47–51.
- Archer, L. Bruce. 1979. *Whatever Became of Design Methodology?*. Design Studies 1(1): 17-18.
- Archer, L. Bruce. 1981. *A View of the Nature of Design Research*. In R. Jacques and J. Powell (ed.) Design:Science:Method. Guildford, UK, Westbury House.
- Asaro, P. Mario. 2009. *Information and regulation in robots, perception and consciousness: Ashby's embodied minds*. International Journal of General Systems. 38 (2): 111-128.
- Ashby, W. Ross. 1952. *Design for a Brain*. London: Chapman & Hall.
- Ashby, W. Ross. 1956. *An Introduction to Cybernetics*. New York: Wiley.
- Beer, Stanford. 1972. *Brain of the Firm*. London: Penguin.
- Broadbent, Geoffrey and Ward, Anthony. 1969. *Design Methods in Architecture*, London: Lund Humphries
- Buckminster, Fuller. 1969. *Ideas and Integrity: A Spontaneous Autobiographical Disclosure*. New York: Macmillan.
- Cannon, Walter B. 1967. *The wisdom of the body*. New York: Norton.
- Cobb, Henry N. 1986. *Architecture and the university: Walter Gropius lecture April 25, 1985, Sanders Theater Memorial Hall*. Cambridge, MA.: Harvard University, Graduate School of Design.
- Conant C. Roger and Ashby W. Ross. 1970. “Every good regulator of a system must be a model of that system,” *International Journal of Systems Science*. 1:2, 89-97.
- Cross, Nigel. 1993. “A history of design methodology.” *Design Methodology and Relationships with Science*, Volume 71,15-27.
- Cross, Nigel. 1982. “Designerly Ways of Knowing.” *Design Studies* 3.4: 221–27.
- Dewhurst, Joe. “British cybernetics.” In *The Routledge Handbook of the Computational Mind* Routledge, edited by Mark Sprevak and Matteo Colombo, 38-51. London; New York: Routledge, 2019.
- Dutta, Arindam. 2013. *A Second Modernism: MIT, Architecture, and the Techno-social Moment*. Cambridge: MIT Press
- Geddes, L. Robert, and Spring, P. Bernard, 1967. *A Study of Education for Environmental Design; Final Report. Sponsored by the American Institute of Architects. Co-Directors: Robert L. Geddes (And) Bernard P. Spring*.
- Gibson, J. James. .1966. *The Senses Considered as Perceptual Systems*. Allen and Unwin, London.
- Giedion, Siegfried. 1954. *Space, time, and architecture; the growth of a new tradition*. Cambridge: Harvard University Press.
- Glynn, S. 1985. “Science and Perception as Design.” *Design Studies* 6(3): 122-133.
- Jones, J. Christopher and Thornley, D. G., (ed.) (1963), *Conference on Design Methods*. Oxford, UK, Pergamon Press.
- Jones, J. Christopher. 1977, *How My Thoughts About Design Methods Have Changed During the Years*. Design Methods and Theories 11(1): 48-62.
- Lawson, Bryan. 1980. *How Designers Think: The Design Process Demystified*. London: Architectural.
- Levy, Richard. 1985. *Science, Technology and Design*. Design Studies 6(2): 66-72.
- Moran, Brendan. “Research Toward a Scientific Architecture” in the *Architecture school three centuries of educating architects in North America*, edited by Joan Ockman. MIT Press, 2012, 386-391.
- Ockman, Joan and Williamson, Rebecca. 2012. *Architecture school: three centuries of educating architects in North America*. Cambridge, Mass: MIT Press.
- Pangaro, Pangaro and Dubberly Hugh. 2015. *How Cybernetics Connects Computing, Counterculture, and Design*. Dubberly Design Office. Accessed January 8, 2021. Retrieved from <http://www.dubberly.com/articles/cybernetics-and-counterculture.html>
- Pask, Gordon. 1969a. *The Architectural Relevance of Cybernetics*, Architectural Design, 39 (September), 494–96.
- Pickering, Andrew. 2010. *The cybernetic brain: sketches of another future*. Chicago: University of Chicago Press.
- Reinhold, Martin. 2001. “Organicism’s Other.” *Grey Room* no. 4: 35– 51.
- Reinhold, Martin. 1998. “The Organizational Complex: Cybernetics, Space, Discourse.” *Assemblage* no. 37 : 103– 27.
- Rittel, W. Horst and Webber, M. Melvin. 1973. *Dilemmas in a General Theory of Planning*. Policy Sciences 4: 155-169.
- Rittel, W. Horst 1973. *The State of the Art in Design Methods*. Design Research and Methods (Design Methods and Theories) 7(2): 143-147.
- Robinson, Howard. 2020, "Dualism", *The Stanford Encyclopedia of Philosophy*, Edward N. Zalta (ed.), Accessed on February 24, 2020. Retrieved from <https://plato.stanford.edu/archives/fall2020/entries/dualism>.
- Rowe, Peter. 1987, *Design Thinking*. Cambridge, Ma., MIT Press.
- Sachs, Avigail. 2009. *The Postwar Legacy of Architectural Research*. Journal of Architectural Education. 62, 53 - 64.
- Simon, Herbert. 1969. *The Sciences of the Artificial*. Cambridge: MIT Press.

- Snow, Charles Percy. 2001 [1959]. *The Two Cultures*. London: Cambridge University Press.
- Thompson, Evan. 2010. *Mind in life: Biology, phenomenology, and the sciences of mind*. Harvard University Press.
- Vandenbroeck, Phillippe. 2020. *Herbert Simon: The Sciences of the Artificial (1969, 1998)*. Medium. Accessed on February 24, 2020. Retrieved from <https://medium.com/@pvshiftn/herbert-simon-the-sciences-of-the-artificial-1969-1998-a9f6294f4717>.
- Walter, W. Gray. 1953. *The Living Brain*. London: Duckworth.
- Walter, A. Taylor. 1959. *A School of Architecture of the Future*, *Journal of Architectural Education*, 14:2, 48-52.

## ENDNOTES

---

- <sup>1</sup> Nigel Cross makes an interesting distinction arguing that the scientific design refers to modern, industrialised design - as distinct from pre-industrial, craft-oriented design - based on scientific knowledge but utilising a mix of both intuitive and non-intuitive design methods (Cross, 1993).
- <sup>2</sup> Influenced by the workshop-based education pioneered at the Bauhaus these labs emphasized hands-on experimentation and exploration of the properties and potentials of materials as the basis of design instruction. The labs by Laszlo Moholy-Nagy at Chicago's Institute of Design, Columbia's Laboratory of Design Correlation, founded by the Viennese emigre Frederick Kiesler in 1936, and Josef Alber's at Black Mountain College introduced a pedagogical model that provoked new approaches to design research, distinct from the fine arts atelier which emphasised the inspirational genius of the individual artist and the mastery of established techniques (Moran, 2012).
- <sup>3</sup> The published proceedings of the 1962 conference contain 17 papers. Contributors included the above-mentioned Jones, Thornley, Page, Froshaug, Alexander and a paper by Joseph Esherick who was professor of architecture at Berkley's College of Environmental Design. From that first event on, *The Design Methods Movement* developed through a series of conferences until the 1980s.
- <sup>4</sup> The Homeostat, an adaptive system built by Ashby in 1948, seeks an ultra-stable state in which it is able to act reliably to maintain the stability of its essential variables against disturbances. Ashby's homeostat fundamental principle emerged via biologist Humberto Maturama's autopoietic theory which extended on the notion of homeostasis as the tendency toward a relatively stable equilibrium between interdependent elements. Walter Cannon (1967) used the term to describe the mechanisms responsible for maintaining certain vital parameters in living organisms. Ashby then extended the concept of homeostasis to give a general definition of adaptive systems and included all systems not only biological organisms —from psychology and biology to social systems and more— .

# Online Bricolage: Toward an Architecture of Scavenged Means, Improvisational Methods and Decentralized Processes

Scott Shall<sup>1</sup>

<sup>1</sup> Lawrence Technological University, Southfield, MI

**ABSTRACT:** Architects, as performers, generally require a script. To produce well-formed work, they, like engineers, planners and most other design professionals, demand a carefully choreographed process and a predictable palette of means and materials that are both specifiable and consistent. Driven, in part, by the historic attachment of these professions to patronage-based supports, this need for premeditated choreography creates a bias toward concerns that are easily measured and goals that are either largely internal to the field or easily quantifiable. It also leads to an innate inability to accommodate idiosyncratic or unexpected means without inflating time, cost and effort.

Unfortunately, this demand for a script is at odds with the promise held by tools currently available to the field – a state of affairs that will only become more pronounced as the technologies supporting these tools continue to evolve. Already, the processing capacity available to the architect permits a much stronger embrace of idiosyncratic materials and complex means than can be deployed when operating within the field's accepted patterns of engagement, as defined by tradition, legislation, and professional training. The sophistication of modeling programs routinely deployed in the design of new work similarly permits the engagement of much vaster, and more complicated, concerns. And the immediacy of widely-available global communication tools, supplemented by the increased capacity of emerging scanning and modeling toolsets, allows for the architect to bring together contributors from around the world to engage thoughtfully in localized concerns, regardless of any given contributor's physical geography.

The paper that follows will demonstrate that, by embracing the full promise of these technologies and tools, the architect will become able to embrace more improvisational forms of practice. The paper will further articulate how this more improvisational performance will permit the professional to build stronger, more authentic dialogues with communities currently quite distant from the architect's practice - communities that are built illegally, using scavenged materials and the improvised tactics of the bricoleur. To illustrate the potential application of the points raised, the paper will conclude with a short study of a series of improvisational design performances deployed as a part of a multi-year project in South Africa, wherein the author worked with a small team of students, designers and faculty to collaboratively design and construct, using scavenged materials, localized means and remote technologies, schools, clinics and other much-needed community assets. Completed on a budget of less than \$2000, these modest projects illustrate the value of an architecture borne of improvisation, and built by contemporary technology.

**KEYWORDS:** extra-legal communities; socially-responsive design; bricolage; scavenged materials

## 1.0 ARCHITECT AS ARTIST

Architecture, in its current incarnation, emerged with the rise of the burgher class in the fifteenth century. As manifest in the methods by which Brunelleschi designed the dome over Santa Maria del Fiore in Florence, this was this moment when the field began its shift from a mechanical art to a liberal art, and the architect from a master-craftsman to a professional (Ettlinger, 1977). Over the course of the next few centuries, this shift would manifest in a unique set of credentialing procedures that were quite similar to those used in fields like engineering, medicine or law. These procedures legitimized the professional, permitting the field to realize a degree of stability. However, unlike other professions, which could draw their authority from science (engineering or medicine) or the state (law), architecture's authority vacillated between the technical rationality of the master builder and the eloquence of the artist. During the 20<sup>th</sup> century, as it became clear that the field's claims to the former were effectively compromised by the technical expertise of the engineer and the efficiencies of the building trades, the profession pivoted to embrace the latter. Aesthetics, not technical competency or superior building, became the root of the field's primary identity and focus, dividing the profession from the trades, and architects from builders (Crawford, 1991).

However, in order to fully realize this shift, the architect required support. For unlike artists, architects generally do not operate freely, but need patrons to fund their resource-intensive work - an association with wealth and power that only solidified as the field shifted away from the technical and economic concerns of the building industry, as well as the



middle-class clientele this industry was designed to serve. During the 20<sup>th</sup> century, this allegiance caused a realignment of the academic and professional frameworks that defined the field, and, transitively, the expertise and interests of those who therein practiced. Matters of construction, economics, structure, and other technical competencies were relegated to second-tier status, and artistic expression, unencumbered by such concerns, became the primary focus (Pecora, 1991). A symbiotic relationship between these professions and society's most influential actors was thereby hard-wired into the field. The work of the architect became a luxury item, buttressed by ideological claims, and isolated from material, economic or other concerns over which the field had little knowledge or control (Hollein, 1962).

So positioned, the field would come to rely upon two sets of measures to define exemplary work. The first would draw from the field's historic attachment to the liberal arts, and the intellectual discourse thereby established, to recognize work that supported the profession's ideological advancement. Architectural theory and criticism played a key role within this professional project, carefully selecting, for celebration and study, projects and practitioners capable of advancing the intellectual domain of the field (Cuff, 1998). Disseminated through academic institutions and professional journals, this created a widely accepted framework for judging excellence over which the field had complete control. Visualizations of work, and their attendant arguments, became the primary concern of both academic and professional acts (Frampton, 1991). The practice of building, when it appeared, played a supportive role within this larger narrative, generally translated through a few carefully choreographed visual representations that depicted the work either before or immediately after construction – a relatively narrow window of time, given the duration of most architectural works.

However, the architect could never fully escape the reality that their work would, one day, be realized. Despite the proclamations of highly-regarded critics, educators, and architects that architecture was above the petty concerns of the building trades, these realities – cost, efficiency, durability – formed an inevitable framework for evaluation for those outside the field, as well as the professional whose work directly served this constituency (Stevens, 1998). This forced the field to incorporate a second set of metrics into the professional project. However, unlike the first set of measures, which enjoyed the support of the academic, professional and critical infrastructure earlier described, these measures had to be widely understood and easily disseminated without the benefit of this infrastructure. This created a bias within this second, competing, set of measures toward simple, easily measured concerns that could satisfy several conditions. First, the measures must be clearly attached to issues that are of concern to a large swath of practice. Clients, builders, contractors and other influential figures within the construction industry must not only understand, but believe in, the need to incorporate these concerns into the work, else they will be ignored as an extraneous expenditure of resources. Second, they must be easily understood. Large, complex arguments generally have difficulty penetrating deeply into the architect's professional discourse without the supportive infrastructure provided by academia and other widely respected modes of dissemination. This is likely why concerns related to environmental sustainability that are assessed by easily understood, and arguably simplistic, measures have been able to penetrate into the field whereas those related to cultural or social sustainability, which do not (yet) have the benefit of such an easily understood set of measures, have not. Third, the offered concerns must directly support the expansion of field's professional position by laying claim to an area of expertise outside the technical competencies of engineering or the building trades. Unfortunately, given the already described biases of the field's prevailing academic focus as well as the architect's related lack of expertise in areas such as real estate development, environmental psychology, and the building trades, meeting this final condition has proven difficult. Yet the costs of not doing so are immense, as demonstrated by the rather ironic translation of the modern movement from the socially-motivated and production-centered concern into a largely aesthetic discourse (Crawford, 1991). Similar fates likely await pre-fabrication and off-site construction as well-funded entities such as mini and IKEA engage these concerns at a scale and proficiency that the field, at least when operating under its current structure, simply cannot match.

## **2.0 TECHNOLOGICAL OPPORTUNITIES**

Fortunately, these professional limitations are at odds with the promise held by the tools currently available to the field – a trend that will only grow in strength as sophisticated tools for scanning, simulation, modeling, and communication become more accessible. Unfortunately, this promise has been somewhat obscured by the field's persistent adherence to the ideological campaign, which promotes the view that these emerging tools and technologies do not represent an opportunity to embrace new forms of practice, but a means to support the field's current focus through the creation of even more elaborate arguments and sophisticated visualizations. This is despite the fact that the tools themselves actually question the utility of such visualizations.

### **2.1 Idiosyncratic Means**

If, however, the profession can overcome this professional inertia and incorporate these tools into a critical restructuring of the field, immense opportunities await. Specifically, if the architect can deconstruct the field to its foundations, and then restructure it in accordance with the tools currently available, they may be able to realize three new potentials. First, the architect may become able to establish forms of practice based upon idiosyncratic materials and means. Instead of requiring materials like wood or stone to be heavily processed – a procedure that adds cost and embodied energy to the material and work – the architect could use current tools to document the harvested product in its natural state, model the element's inherent properties and then incorporate each, distinct element into the work. After all, the rationale for embedding this additional cost and energy into natural products was based upon the fact that those in the

building industry lacked the ability to incorporate their naturally-occurring idiosyncrasies into the built work. Given current tools, and their immense processing capacity, it seems reasonable to ask whether or not this investment remains necessary. Does the field still need wood to be processed into 4'-0" x 8'-0" sheets or 2" nominal products? Work by Whole Trees Structures would seem to indicate that this is not the case (Goldsborough, 2019). Just as compelling is the potential impact answering this question might have upon the use of reclaimed material, potentially removing a key hurdle from its wide-spread utilization – namely, the unpredictability of what is reclaimed – and paving the way for a much more radically sustainable building practice.

## 2.2 Idiosyncratic Sites

Second, by rethinking the field's approach, the architect may become able to embrace more idiosyncratic sites, which could, in turn, lead to a more efficient embrace of complex site conditions, such as those engaged in adaptive reuse. The unique nature of the sites engaged in this type of work, and the unknown properties of their elements, have caused these projects to take longer to design and construct, and cost more than new construction. At times, these costs are significant enough to be greater than the projected revenue for the work, directly leading to the need to demolish the existing architecture and then construct a new work on the now cleared site. Yet, is this approach still necessary when one considers the processing capacity of current technology and how quickly and easily drones can scan existing sites and buildings already? Or how easily more sophisticated drones and robots, supported by even faster and more proficient processors, might do so tomorrow? Although still too expensive to be widely deployed, tools like Spot - a robotic dog created by Boston Dynamics and deployed by Foster and Partners that is designed to walk through, and document, buildings before, during and after construction – portend interesting opportunities in this regard for the field (Block, 2020). Given these immense potentials it seems reasonable to assume that the efficiency of these processes demands a recalibration of how the field engages the existing built environment. Or that they soon will. And that these tools, if thoughtfully engaged, have the potential to increase the number of feasible projects, and to expand the field's role within them.

## 2.3 Expanded Body of Contributors

Third, these tools can lead to a radical expansion of who is able to contribute to each project. Already used to establish clear communication lines with clients, consultants and other well-established contributors, the ability to easily communicate around the world in real time presents the field with an opportunity to reshape how practitioners communicate with not with these actors, but everyone impacted by the potential work. It also presents an opportunity to rethink how the insight offered by this expanded body of experts might be incorporated into the process of design, construction, occupancy, and inevitable re-construction of the work. Once established, this more inclusive process would, in turn, demand a thoughtful restructuring of the relationship between all these contributors, and the field itself (Foucault, 2002). Already, the sophistication of scanning and digital toolsets only serves to support this dialogical expansion by making available detailed information about the site and project to all parties, equally and simultaneously. Yet these opportunities are also currently encumbered by their subservience to the prevailing structures of practice. This is perhaps most powerfully demonstrated in the tentative manner by which architects incorporate all non-client users and the larger public into the conceptualization and design of the work. Whereas industries such as software development have been radically changed by these communications tools, and the natural shuffling of hierarchies thereby created, the process of the architect has not. Although this negligence impacts those engaged in community-based or socially-responsive architecture most directly, all projects undertaken by the architect are arguably impacted. And all would stand to gain, should the practitioner seek to use these tools to create more open source, inclusive, and democratic design processes. Is it possible for architecture to become a product of open-source development (Surowiecki, 2005)? Or for the architect to deploy these tools to not simply communicate with their consultants or the client, but to incorporate effective tactics of developmental communication strategies, and authentic dialogue, into practice (Friere, 2000)? And, if so, would this recalibrated workflow completely upend the hierarchies demanded by traditional patronage-based processes for more inclusive and heterarchical practices? Architect Alejandro Aravena of Elemental provides the field with a tantalizing glimpses into this potential future. As does the work of wikhouse (Flynn, 2018).

It is important to note that this is not the first time that rapid technological advancement has offered the field the opportunity to shift practice and expand the architect's role. The Industrial Revolution offered similar opportunities, as did the technological advancements brought about by World War 2. However, it is arguably the first time when these advancements were not neatly aligned with the training, values or practices of the engineer.<sup>1</sup> And it is this misalignment that could protect these opportunities from a similar fate. For although each of the technological advancements cited above are well aligned with existing practices – industrial production and robotics, virtual reality and game design, 3d scanning and anthropology - none of these practices are currently in command of these tools, as a set. And no one – least of all the engineer – has thus far incorporated them into the design of the built environment. Nor have those engaged in the building trade, for whom the engagement of idiosyncratic materials, sites and practices is viewed as inefficient and unnecessary. Thus, they have the potential to offer the architect new forms of practice as much in the domain of profession as the theoretical campaign that has served as the centralizing muse for the field over the last century.



**Figure 1:** Material Practice within Extra-Legal Settlements, Mumbai, India (Shall 2008).

### 3.0 ARCHITECT AS BRICOLEUR

It is perhaps appropriate that the roots of this particular professional evolution are found in the pre-architecture roots of building – forms of practice that remain very much in use today within extra-legal settlements around the world. Built using unapproved methods on land that illegally acquired, the residents of these settlements design and construct in a manner drastically different than the process used by the engineer or architect (UN-HABITAT, 2012). In these settlements, and in all areas prior to the establishment of the profession, people build using pre-constrained elements, allowing the design to emerge in response to whatever is available (Figure 1). If these elements are refined, they are refined in accordance with local custom, based upon tested knowledge and direct engagement. It is important to note that this is true not only in matters directly related to the material practice of building, but the manner in which all elements of the built environment are realized (Theime and Kovacs, 2015).<sup>ii</sup> Electricity is not something provided by an assumed connection to the civic grid but offered through a set of local negotiations through which the community might borrow this power without cost – an infrastructure of support that is refined over time through direct, localized testing and development. As such, the resident-builders of these communities see no need to remove inconvenient anomalies of a given site or structure prior to construction. They build within a network of virally-propagated wisdom: how to best use tarp to collect rainwater, when the next government sweep is to take place, which parts of the electrical grid are least protected (Davis, 2006). Building within such a fluid network, the resident-builder sees no reason to establish practices of construction that would require rigid hierarchies or isolating practices. After all, their entire settlement exists in defiance of these hierarchies and structures (Theime and Kovacs, 2015).

In essence, they build as bricoleurs (Shall, 2018). And within their seemingly rudimentary approach rests the clues to a more thoughtful professional embrace of the emerging technologies and tools that now confront the field of architecture.





**Figure 2:** The community event- and maker-space was constructed of scavenged materials using common tools and accessible means. The final work was completed in less than 10 days with a team of 11 for under \$1500 (Shall 2019).

### 3.1 Inverting Design and Specification

The first, and most foundational, clue toward this new practice is the inversion of design and specification. In the current practice of architecture, design is based upon largely internal, ideological concerns, which are, at times, supported by metrics related to ideals of structural performance or environmental impact. For the engineer, the design of the work is based almost entirely upon the latter ideals. For the contractor, design serves to support the efficiency of labor, funding and other resources, as measured at the time of construction. In each case, these entities operate under the assumption, and with the support, of a known set of predictable components whose attributes are both consistent and prescribable to high degree of detail. To design a structure, the engineer, architect and builder all require an inventory of carefully measured steel components and heavily specifiable concrete mixes to create designs that optimize performance, in terms of direct relevance to their goals of efficacy, optimization, or performance. The bricoleur inverts this process, allowing the design to emerge in response to the elements at hand (Levi-Strauss, 1968).<sup>iii</sup> In the bricoleur's design process, the elements are considered a pre-constrained given to which all other project attributes must adjust. Programs shift in accordance to the elements available, as activities that may have initially been thought of as internal, and housed within an enclosed space, are moved to external spaces sheltered under a canopy or protected by a screen. Or the pre-constrained set might engender a phased approach to construction, through which the bricoleur establishes a hierarchy of needs within the work that might otherwise not appear. Conversely, the set of pre-constrained elements might highlight new opportunities, enabling the built response to grow and support activities that were not a part of the initial conception. In the bricoleur's design, all attributes of the work – the spans realized, the area enclosed, the character of the spaces created – find their root within this constrained set of parts and must adjust to this reality.



**Figure 3:** Design attention was placed in service of common, scavenged means in order to maximize the value of pre-constrained means (Shall 2019).

To illustrate how this inversion of means and ends might manifest within contemporary architectural practice, we might consider a modest multi-year project in South Africa, wherein small teams of students, designers and faculty are working collaboratively with local residents to design and construct, using scavenged materials, localized means and remote technologies, schools, clinics and other much-needed community assets. Completed on budgets of around \$1500, these works illustrate the value of an architecture borne of improvisation, and built by contemporary technology. The first phase of this effort, which was completed in 2019, is centered upon the construction of a community event- and maker-space in Port Elizabeth – a program is both foundational to future work and flexible enough to adjust to the pre-constrained components that would provide the foundation for the design response. Initially motivated by the modest means afforded the project – namely the need for a team of eleven to design and construct the structure in ten days for less than \$1500 – this necessary recalibration of the design, construction and occupation process reverberated throughout the effort. (Figure 2) To start this process, the design team first learned everything they were able to about their scavenged stock of potential building elements. Every piece of scrap was photographed, measured and modeled in both Revit and Rhino with as much detail as possible. Idiosyncrasies within elements were carefully catalogued and noted. Simultaneous to the digitization of scrap, the team tested the elements to determine their structural integrity, durability and other attributes of concern to the ambitions of the work. Once uncovered, this insight was then incorporated into the inventory and then brought to bear upon the knowns of the project itself: the dimensions of the structure and orientation on the site, how the structure's mass might be positioned to accommodate circumstances such as solar positioning, severe winter winds or the required turning radius for trucks delivering or removing building elements for future developments, and the absolute minimum acceptable parameters for the programmed spaces. The fact that the work had to be realized using only the given stash of materials – a stash that only contained so many items of any value to structural or cladding concerns - greatly limited the set of potential formal approaches to the project, resulting in the relatively quick resolution of the overall massing of the work. This caused the team to focus greater energies upon detailing the work – an investment of energy that would, eventually, help to maximize the value and effectiveness of the assembled parts. It was here that the group turned to precedents provided by architects operating in more formal settings. For example, the joinery of Thorncrown Chapel provided the team with an approach to designing the roof purlins with component parts much too small for the task. Figure 3) Similarly, the work of Tom Kundig inspired the reclamation of wheel bearings and the creation of several pivoting walls so to allow for the expansion of the architectural envelop during larger events – events much too big to be accommodated within the structure itself, based upon the pre-constrained inventory of elements. It is important to note that this last set of details, which required massive elements of the architecture to slide or pivot, were only possible because the local partners in the work had gathered axles from drivetrains and other unique elements, just in case (Levi-Strauss, 1968).



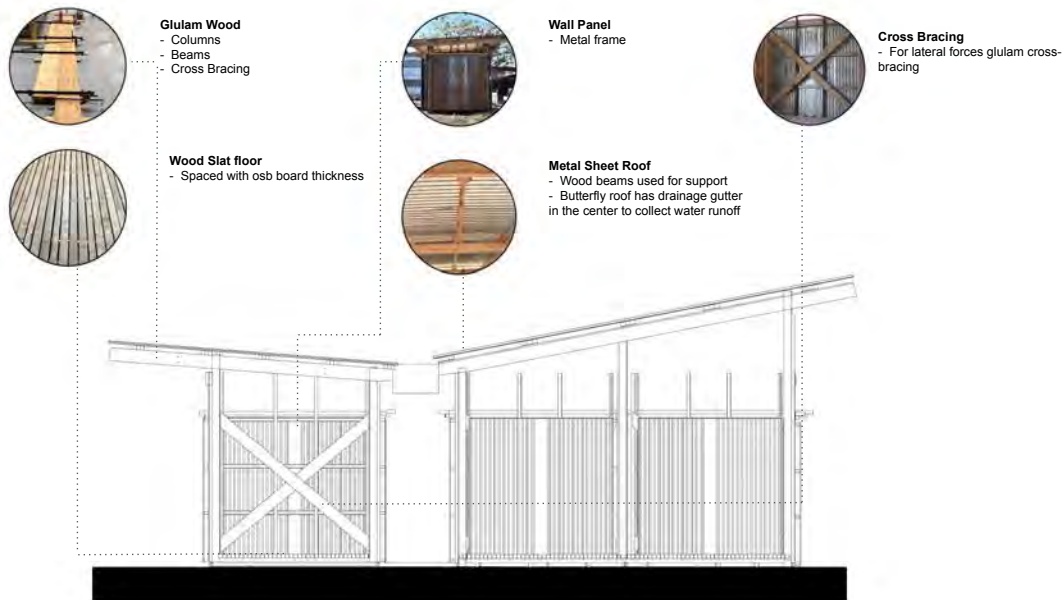
**Figure 4:** Laminated wood scrap for the roof structure reserved more valued materials for other structures and uses (Shall 2019).

### 3.2 Creating Nimble Value Structures

From this emerges a second aspect of bricolage construction which may be of value to a recalibrated field: the fluidity of the value structure assigned the gathered resources. For although some of this valuation will obviously be related to concerns common to the architect, engineer, and bricoleur, the fluidity with which these values are assigned is quite distinct to the bricoleur. In all fields related to building, properties such as structural capacity or strength, will play a key role, as these attributes are foundational to any structure that must contend with gravity, corrosion, or abuse. Similarly, in all these fields, elements with rare attributes or unique capacity will generally have greater value than those that do not. That stated, it is important to note the exclusion of attributes such as aesthetics or prestige for the bricoleur, as

these assets are not generally a part of the value structure assigned to the found parts, but are attributes developed through the treatment and detailing of these scavenged elements, as earlier described. Another key difference: the architect and engineer, unlike the bricoleur, are free to assume that they will be able to specify any number of steel sections or any type of concrete without risk of exhausting supply. In contrast, the bricoleur can easily exhaust their supply of elements that are capable of unique feats - longer spans, greater insulation, more durability. This causes the bricoleur to keep in reserve the elements of greatest value until it is proven by tested experience that other more common elements cannot be amended to accomplish the same end. As a result, the bricoleur will often experiment with the most common assets in their inventory. Aside from generating value in something easily found, this allows the bricoleur to reserve rarer elements for crucial situations. Returning to the project in Africa, the bay spacing for the structure was established by the size of the metal palettes donated by a local Isuzu assembly plant (Figure 4). Although this allowed these palettes – a useful, common element – to serve as the structure for the floor and envelop for the walls, it posed a problem at the roof where the required slope would render these panels too short. Rather than amend these elements, which had already proven their value within the floor and wall assemblies, the team turned to the mountain of short, wood scraps which had been pulled from the surface of these palettes. After some experimentation, it was determined that by laminating these scraps of wood together, the desired span and strength might be achieved. This not only allowed the team to reserve the panels for future work, but bestowed value upon formerly value-less elements within the material library, causing a recalibration of the value structure.

## Street Entrance



**Figure 5:** The innovations, in terms of both process and product, uncovered through the completed community event- and makerspace have been reinvested in the design of clinics, schools, material libraries and other much-needed community assets (Shall 2020).

### 3.3 Expanding Material Constraints

A third attribute of value to this professional restructuring is found within the manner in which those involved in the work might facilitate the constant expansion of this pre-constrained library of components. This expansion can be achieved in two ways: by either expanding the raw materials included within the library or by expanding the bricoleur's understanding of those already included. The experimentation of wood scrap cited earlier is a clear example of the latter approach; the collection of wheel bearings "just in case" is a great example of the former. In either case, the expansion is subject to the knowledge offered by direct experience with the existing store of material. That is, if elements that can span 15 meters are commonly needed and quite rare, then the bricoleur will put forward great energy to either find or create components capable of achieving this end. Expense can also factor into this assessment, as the bricoleur often confronts the need for components and parts which cannot be obtained without cost. For example, although around half of the hardware used in the South African makerspace was scavenged, the other half had to be purchased. Similarly, although the team had enough time to glue laminate the scrap into beams, there was not enough time to do the same with the wood used for the columns, resulting in the need to purchase this asset. And although \$1500 is a modest cost for a structure the size of the now-completed makerspace, if even \$500 of savings can be achieved through the expansion of the material library, then 33% more projects can be realized, making the investment of time well worth



the effort. Thus, it is not surprising that immediately after the completion of the first work, Kevin Kimwelle, founder of Indalo World and the chief tenant of the makerspace, began to experiment with the glue laminating process to see whether or not all future wood members could be fabricated of scrap – experiments that would quickly prove successful. This was caused wood scrap to become a surprisingly useful, and valued, commodity within the material library. It also led a small team of designers to experiment with the use of these elements to realize double-height spaces, which Mr. Kimwelle and his team in South Africa have since deployed to build a home within a post-Apartheid settlement in Port Elizabeth and which subsequent design teams have used to design, remotely due to Covid-19 travel restrictions, a two-story build shed, medical clinic, sustainability center, and sprawling material library in the summer of 2020. (Figure 5) Through these processes, the design team leveraged online tools common to all participants – a limitation that can be severe when working within communities of great need – to expand the body of experts testing the components within the library to better understand their potential, and instigate searches for new materials. These largely digital exercises were supplemented by the direct experimentation conducted by our partners in South Africa, creating a dialogue between ancient and emerging technologies and approaches, supported by experts from around the world.

Although obviously limited in direct application due to its unique situation and support structure, this work is able to provide a few clues as to how the field might shift to realize work that is not supported by patrons, predictable means or easily measured contexts. Appropriately deployed and developed, these clues might forge a dialogue, through which humble works, like the project in South Africa, might offer the practitioner the means to realize new forms of practice, to the benefit of not only the architect's current client base, but all those who might be helped by an expanded practice.

## REFERENCES

- Block, I. 2020. "Foster + Partners adopts Spot the Boston Dynamics robot dog." *Dezeen*, November 13 2020.  
<https://www.dezeen.com/2020/11/13/foster-partners-adopts-spot-the-boston-dynamics-robot-dog/>
- Crawford, M. 1991. "Can Architects Be Socially Responsible?" In Ghirardo, D (Ed.), *Out of Site: A Social Criticism of Architecture* (pp. 27-45). Seattle, WA: Bay Press.
- Cuff, D. 1998. *Architecture: The Story of Practice*. Boston, Massachusetts: MIT Press.
- Davis, M. 2006. *Planet of Slums*. New York, NY: Verso.
- Ettlinger, L. 1977. "The Emergence of the Italian Architect in the Fifteenth Century" In Kostoff, S (Ed.), *The Architect* (pp. 96-123). London, England: Oxford University Press.
- Flynn, K. 2018. "Open Source for Everyone?" *Architect*. April 4, 2018.  
[https://www.architectmagazine.com/aiaarchitect/aiafuture/open-source-for-everyone\\_o](https://www.architectmagazine.com/aiaarchitect/aiafuture/open-source-for-everyone_o)
- Frampton, K. 1991. "Architecture: A Critique of Contemporary Production" In Ghirardo, D (Ed.), *Out of Site: A Social Criticism of Architecture* (pp. 17-26). Seattle, WA: Bay Press.
- Foucault, M. 2002. "Space, Knowledge, Power, Interview with Paul Rabinow." In Leach, N (ed.), *Rethinking Architecture* (pp. 367-379). New York, NY: Routledge.
- Freire, P. 2010. *Pedagogy of the Oppressed*. New York, NY: Continuum International Publishing Group.
- Goldsborough, J. E. "WholeTrees is Smartly Repurposing Timber Across the Midwest." *The Architect's Newspaper*, October 23, 2019. <https://www.archpaper.com/2019/10/wholetrees-studio-visit/>
- Hollein, H. 1962. *Absolute Architecture*. In Conrads, U (Ed.), *Programmes and Manifestoes on 20th Century Architecture* (pp. 181). Cambridge, Mass: MIT Press.
- Levi-Strauss, C. 1968. *The Savage Mind*. Chicago: The University of Chicago Press.
- Pecora, V. 1991. "Towers of Babel" In Ghirardo, D (Ed.), *Out of Site: A Social Criticism of Architecture* (p 46-76) Seattle, WA: Bay Press.
- Shall, S. 2018. "Guerrilla Architecture and Humanitarian Design." In Arefi, M. and Kickert, C., eds. *Bottom-Up Urbanism*, New York: Palgrave-MacMillan.
- Stevens, G. 1998. *The Favored Circle: The Social Foundations of Architectural Distinction*. Cambridge: MIT Press.
- Surowiecki, J. 2005. *The Wisdom of Crowds*. New York, NY: Anchor Books.
- Thieme, T., & Eszter K. 2015. "Services and Slums: Rethinking Infrastructure and Provisioning Across Nexus. In Economic and Social Research Council." Retrieved from [http://www.thenexusnetwork.org/wpcontent/uploads/2014/08/ThiemeandKovacs\\_ServicesandSlumsNexusThinkpiece2015.pdf](http://www.thenexusnetwork.org/wpcontent/uploads/2014/08/ThiemeandKovacs_ServicesandSlumsNexusThinkpiece2015.pdf)
- UN-HABITAT. 2012. "Housing and Slum Upgrading." Retrieved from <https://unhabitat.org/housing-slum-upgrading>

<sup>i</sup> This is what led to the translation of the modern movement earlier described – at that point in history, the engineer, in training and perspective, were aligned with the concerns of industrial production, whose systems lay at the core of the emerging movement (Crawford, 1991).

<sup>ii</sup> "Particularly when it comes to basic service provision, a form of 'malevolent urbanism' has generated across urban areas in the global South, where unequal access to and use of the city is prevalent. At the same time, a mosaic of actors, sectors, and initiatives seek to address the 'challenges of slums', usually purporting to work *with* local communities, but often misunderstanding how everyday practices and expectations might differ from externally defined development goals and impact measures." (Thieme & Kovacs, 2015)

<sup>iii</sup> "The 'bricoleur' is adept at performing a large number of diverse tasks; but, unlike the engineer, he does not subordinate each of them to the availability of raw materials and tools conceived and procured for the purpose of the project. His universe of instruments is closed and the rules of his game are always to make do with 'whatever is at hand', that is to say with a set of tools and materials which is always finite and is also heterogeneous because what it contains bears no relation to the current project, or indeed any particular project, but is the contingent result of all the occasions there have been to renew or enrich the stock or to maintain it with the remains of previous constructions or destructions. The set of the 'bricoleur's' means cannot therefore be defined in terms of a project (which would presuppose besides, that, as in the case of the engineer, there were, at least in theory, as many sets of tools and materials or 'instrument sets', as there are different kinds of projects). It is to be defined only by its potential use or, putting this another way and in the language of the 'bricoleur' himself, because elements are collected or retained on the principle that 'they may always come in handy'. (Levi-Strauss, 1968, 17-8)

# The Medium Isn't the Message Anymore: When the Renderings were Too Good to be True

Aaron Brakke<sup>1</sup>

<sup>1</sup>University of Illinois, Champaign, IL

**ABSTRACT:** Harnessing the early potential of computing to create hyper-real images had implied an unparalleled power to communicate “truths” of architectural ideas and intentions. The increasing access to advanced computation has permitted architects to create renderings that are very accurate and realistic, yet the representations produced by architects and urban planners continue to carry inherent distortion. Research that investigates the agency of representation in architecture, recognizes the increased performative nature of presentation drawings. With their ability to ‘fabricate’ images of space, computer generated images “further problematize the relationship between the image and the thing” in a world where “collective imagery is a major field of ideological struggle” (Altürk, 2008). This paper examines the politics of using and mis-using architectural image making when interfacing with the general public. The authors draw upon observations of a polemical project related to urban green infrastructure located in Bogota and use the documentation of this case study to develop a reflection about the politics of image making. Through the development of this narrative, the authors raise questions about the ethical dimension of the profession.

**KEYWORDS:** Visualization, Image Decolonized Futures, Matters of Concern and Care, Futuring

## INTRODUCTION

*It is the reflection of a profound reality;  
It masks and denatures a profound reality;  
It masks the absence of a profound reality;  
It has no relation to any reality whatsoever: it is its own pure simulacrum.*  
- Baudrillard

In 1995, the graphic design world was rocked by David Carson’s *End of Print*. As suggested in the title, the Carson’s provocation was that the state of printed media was shifting towards a new uncharted terrain. Uncompromising cineaste Peter Greenaway followed up a decade later and proclaimed that the death of cinema occurred in 1983 when a small complementary invention, the remote control, reached the domestic interiors of homes around the world. *Oculus 57* from June 1995 gathered feedback from Hani Rashid and Greg Lynn, the architectural professors at Columbia University who were running the “Paperless Studio” and attempting to undermine the use of one physical and material component that had been an essential part of the architectural design process for several centuries. Now more than a quarter century later it is safe to say that the barking of these figures about bold propositions in their respective fields might have been louder than the actual bite. However, the process of making virtually every form of art and design has become radically altered through the absorption and adoption of digital technologies. The current state of readily accessible advanced computation has permitted architects to create renderings that are very accurate and realistic, yet the representations produced by architects and urban planners continue to carry inherent distortion. Research that investigates the agency of representation in architecture, recognizes the increased performative nature of presentation drawings and the “undeniable charm of slick, smooth translucent and reflective surfaces” they awake in their audience. With their ability to fabricate space, computer generated images “further problematize the relationship between the image and the thing” in a world where “collective imagery is a major field of ideological struggle” (Altürk, 2008).

Similarly, thinking of the urban as a symbol of a dominant set of urban relations, Swati Chattopadhyay recognizes that “only certain people and institutions have the language, resources and authority to make themselves and their ideas manifest in public” (2012). Grounded in this acknowledgement, Tran O’Leary et.al use a case study of landscape architecture in a racialized setting to illustrate how “the authority of design elite” can be decentered (Tran O’Leary, Zewde, Mankoff, & Rosner, 2019). Hsueh, et al. have argued that space is rendered into a commodified version of itself and argue that digital architectural representations encourage us to mimic the forms of occupation proposed in the renders, while limiting our ability to think of the potential social impacts of architecture (Hsueh, Chu Hoi Shan, & McGrath, 2016). This paper will contextualize architectural practices of representation and discuss how politicians and developers (mis)communicated a planned project for green infrastructure in Colombia, how messages masked intent and how citizens have responded to the actual content that has been delivered. Framed by the politics of futuring, it is a pressing concern in times that urge us to decolonize futures and imagination (Miraftab, 2017; Nederveen Pieterse & Parekh, 1995) in order to be able to bring alternative just futures into existence.

## 1.0 CONTEXT

### 1.1. Introducing the Case Study and Framework of the Article

Social and spatial relationships are conditioned by the physical scaffolding of urban morphologies that are shaped by the hegemonic orders of governing bodies. Determining how to create healthy, equitable, prosperous and resilient cities relies on multiple cross-disciplinary mechanisms. In this article, a reflection is articulated about the particular moments in which the 'city as a thing' is brought forward. The framework is the planning and development of initiatives that are projected on strategic urban ecosystems—specifically wetlands in the city of Bogota—and the formation of a concerned public (Latour & Weibel, 2005) around the issue. We analyze the different identities that emerge in a particular debate and the strategies that they use to become visible and relevant. Finally, we discuss how the hegemonic order attends or ignores the calls for radical democracy extended by Mouffe, Latour and de la Bellacasa and their relations to the design practice.

### 1.2. The Political

Thinking about what a better future might be like and making decisions about how to achieve that future are political matters. Chantal Mouffe proposes the idea that every order that frames these decisions is a hegemonic order, which means the exclusion of alternative possibilities is necessary. This moment—the decision or closure—according to Mouffe, cannot be avoided and should instead be managed in an agonistic model of democracy. It is this acknowledgement of the inherent conflict that exists in human societies that characterizes Mouffe's approach to democracy. In her work, she distinguishes between 'the political' and 'politics'. The political refers to the unavoidable antagonism that emerges in multiple forms in social relations and which is the basis of identity and the definition of us and them. Politics, refers to the "ensemble of practices, discourses and institutions that seek to establish a certain order and to organize human coexistence in conditions that are always potentially conflicting, since they are affected by the dimension of 'the political'" (Mouffe, 2013, pp. 2–3). However present the political antagonism may be, agonistics becomes more about recognizing the 'other' as an adversary instead of viewing him/her/it as an enemy. Adversaries share allegiance to democratic principles while disagreeing about their interpretation, whereas enemies deny each other's legitimacy in the fight for their interpretation to become hegemonic. In thinking of things as gatherings, Bruno Latour calls upon Isabel Stenger's notion of cosmopolitics to explain how a particular democratic assembly is conformed around an issue (Stengers, 2005), and as Maria Puig de la Bellacasa explains, in this framework it is "the moment of irruption of a challenging entity that pushes to redefine what is the thing, the 'issue', at stake that better invokes the cosmopolitical moment: that is, when a gathering is tested about what it counts as its world" (Bellacasa, 2017, p. 46).

The question then, is not only what future are we going to decide on, but how are we going to make decisions to achieve that future. In democratic contexts, the question of how many we are becomes relevant. De la Bellacasa draws on Latour and Stengers in order to think about how the cycle of inclusion and exclusion of the public on a particular issue redefines the issue. She warns against the state of being unaffected by those who are not yet interested nor invested in the issue, which might lead to the pacification of cosmopolitics. Thinking with care about what could be going wrong in a particular issue, even if not all affected entities are directly involved in the debate, and thinking with care about the divergences and oppositions that may be created when the assembling of an issue is questioned—when the extension of a particular network is challenged—involves thinking of humans as interdependent beings in a network of human and non-human entities and remaining responsible to those who are excluded, consciously or not (María Puig de la Bellacasa, 2017; Haraway, 2016). In the Global South, a hegemonic rationality has driven the development of large cities in the form of marketable commodities (Glaeser, 2011; Goldman, 2014; Soto, 2000). Goldman quotes the 2009 address of World Bank President Zoellic in which he calls infrastructure a cornerstone or the global recovery strategy for the economic crisis while showing concern for the needs of millions of people still living without safe water, electricity, sanitation, roads and "other amenities of modern life". This double benefit is a trademark of hegemonic rationality, which is often put into practice with a feeling of obligation, a burden to save, help or provide, while finding reasonable grounds and means to perform perpetual capitalist reinvestment (Harvey, 2012). Discourse alone then provides limited understanding of the nuances in play in the reproduction of the city. In the words of feminist technoscience scholar Donna Haraway: "the details matter" (Haraway, 2016, p. 29). It is in practices and actions that we encounter the ways in which entities remain response-able to each other, or render others invisible to keep moving forward with business as usual (Haraway, 2016).

In this article, we reflect on particular moments in which the city as a thing is brought forward. The framework is the planning and development of initiatives that are projected on strategic urban ecosystems—specifically wetlands in the city of Bogota—and the formation of a concerned public (Latour & Weibel, 2005) around the issue. We analyze the different identities that emerge in a particular debate and the strategies that they use in order to become relevant. Finally, we discuss how the hegemonic order attends or ignores the calls for radical democracy extended by Mouffe, Latour and de la Bellacasa.

### 1.3. Framing the Context

We situate our work in the Latin American city of Bogota and we write at a time when thousands of Colombians have gone to the streets to protest and demand the government's attention to the urging needs the population. The confident

economic growth of the country contrasts with the situation in the rest of the region but mainly, with the elevated indexes of internal inequality and corruption. The streets of the capital city of Bogota have held numerous demonstrations since the start of the national civic strike on November 21<sup>st</sup>, 2019. This city encompasses complicated dynamics as it tries to accommodate the hegemonic imaginary of a global city and the multiple conflicts that have derived from its erratic and accelerated growth. For decades, Bogota has kept the debate about the city alive. Amongst them, a prominent sector has made urban environmental matters into 'matters of concern' (Latour, 2014) or perhaps, into 'matters of care' (Maria Puig de la Bellacasa, 2011). In his work, Quimbayo Ruiz discusses the emergence of a social movement that advocates for urban nature and has been active in Bogota since the 1980s. Quimbayo explains how the movement has built a "territorial attachment with some elements of urban nature through the re-appropriation of regulations, and technical-scientific concepts, such as the MES (Main Ecological Structure)" (Quimbayo Ruiz, 2018, p. 532). Wetlands are a significant part of the Main Ecological Structure and they have caused a variety of affects and territorial attachments with the citizens. The wetlands in Bogota that are officially recognized are shown in Figure 1.



**Figure 1:** Recognized wetlands in the Urban Area of Bogota. [Map: Authors, 2020.]

In its origins, the environmental concerns of popular sectors in Bogota were linked to their desire to improve their own neighborhoods and communities, since they were located at the core of environmental conflicts that included urbanization in mountains and wetlands or landscape affectations due to urban mining (Cruz & Salazar, 2017; Ruiz, 2014; Villa, 2012). Quimbayo Ruiz relates how the movement appropriated the environmental discourse and how institutionalized means of participation like Environmental Local Planning agendas, Communal Action Boards (JAC) and Local Management Boards (JAL) were established. However, he quotes Londoño (2008) in explaining that the social movements deemed these institutional spaces of participation insufficient because in many cases they were manipulated by certain political interests, or because they acquainted as a mere formality with no actual incidence in political decisions about the city.

In parallel to these ongoing struggles, the imaginary of the global city gained ground, particularly during the last administration. The 2016-2019 mayor of Bogota, Enrique Peñalosa, adopted the slogan "unpopular, yet efficient" in order to contest citizens' discontent in surveys and social media. Efficiency translates into a vast number of civil works undertaken around the city and displayed prominently in the media. It is the trademark of the portrayed global city: productive, reliable and attractive to foreign investment. At the same time, liberal inclusion took the form of efforts to democratize public space while claiming to engage public participation in planning decisions. Woldeamanuel and Palma have studied the gaps between planning practices and local communities. They assert that "often, it seems that there is a neoliberal belief that in carrying out urban transformations, governments are helping the poor, and 'the invisible hand' of market decisions will determine economic outcomes that benefit all, including the poor and ethnic minorities" (Woldeamanuel & Palma, 2015). This type of discourse was a cornerstone of the Bogota administration during the 2016-2019 period. However, understanding real democracy as rooted in civil deliberation inside and outside invited spaces of participation (Miraftab, 2017) means paying attention to "the processes and the people who participate in acts of consent" (Avril & Neem, 2014, p. 4).

## 2.0 POSSIBLE FUTURES

### 2.1. Rendering Urban Futures and Inherent Biases

As expressed above, the global imaginary of Bogota has been recently championed through a particular use of images and digital representations. Before, Gallini and Osorio studied how modern cartographic representations of Bogota

silenced nature as an indicator of “the process of building a modern city, divorced from its ecological structure” (Gallini & Osorio, 2015). Regarding digital architectural representation Hsueh, et al. have argued that space is often rendered into a commodified version of itself that can hijack the actual space and define its future. They posit that digital representation encourages us to mimic the gestures and poses proposed in the renders, while limiting our ability to think of the potential social impacts of architecture (Hsueh et al., 2016). Altürk investigates the different agencies of representation in architecture, recognizing the increased performative nature of presentation drawings and the “undeniable charm of slick, smooth translucent and reflective surfaces” they awake in their audience. With their ability to fabricate space, Altürk says, computer generated images “further problematize the relationship between the image and the thing” in a world where “collective imagery is a major field of ideological struggle” (2008).

Bringing all these matters to the foreground, the politics of representation in the case of urban planning and architecture can be understood as part of the politics of ‘futures of the city’; of being able to bring particular visions into existence, or even into discussion. The insistent marketing efforts of the local administration of Bogota during the 2016-2019 period have been investigated by the Foundation for Press Freedom (FLIP), who concluded that the administration spent an enormous amount of money in publicity, which was sometimes presented as impartial journalism reports (2018). An image in one of these marketing examples is shown in Figure 2. In this context, digital images become part of the practices and discourses that make politics and that, as Mouffe affirms, are always crossed by the dimension of ‘the political’ and of the reproduction of an us/them difference in the establishment of an order.



**Figure 2:** El Tiempo (2018) Render from press special hired by the local administration, July 2018. The caption read: “The urban equipment for the Lagos de Torca project will follow the newest parameters: green spaces will abound” [Render: El Tiempo, Bogota]

## 2.2. [PAR]ticipating and Engaging with the Urban Periphery

We draw from engaged scholarship in the form of Participatory Action Research (PAR) in the Political Administrative Unit (localidad) of Engativa in the northwest part of Bogota. PAR emerged from the shortfalls of normal science to account for the life conditions of marginalized populations in the 70s. It involves researchers and participants working together to examine a problematic situation or action to change it for the better (Wadsworth, 1988). Our engagement recognizes the work of individuals and collectives that challenge the modern hegemonic notion of urban development in Bogota. We refer to spatial imaginaries as Wendy Wolford (2004) does, drawing from Lefebvre, as “cognitive frameworks, both collective and individual, constituted through the lived experiences, perceptions, and conceptions of space itself” (Lefebvre, 1991).

In the scenario described before, a number of urban projects were proposed by the administration in the 2016-2019 period, overlapping areas of strategic ecosystems in the city. Still today, socioenvironmental organizations continue to mobilize against some of these projects. We focus on one project proposed in the Political Administrative Unit (localidad) of Engativa. Figure 3 shows the Political Administrative Unit of Engativa and its wetlands. In the Jaboque and Juan Amarillo wetlands the city planned to build environmental corridors, which included paths for bicycles and pedestrians, environmental classrooms and recreational areas. The process from design to execution was framed as a participatory project that would recuperate the ecosystems and allow for their use on behalf of the community, as a public space. In this way, the administration asserted its civic vision for urban wellbeing and democracy. However, local neighbors, environmental organizations and some city council members were not content with the participatory process or its results and the projects faced several obstacles in all stages. In order to illustrate what these spaces of participation were like and their relation to the processes and products of design, we zoom into a particular scenario in which the designs for the Jaboque environmental corridor were presented to the local community. This occurred at a fair that the Bogotá Drainage and Sewerage Company (EAAB) mounted on the central plaza of Engativa.





**Figure 3:** The Political Administrative Unit of Engativa and its three wetlands. [Map: Authors, 2019.]

### 2.3. A Story of Urban Democracy?

Engativa is a district located in the northwestern part of Bogotá. Before colonial foundation the territory was inhabited by Musica indigenous people and it was referred to as Ingativa. Scholars have drawn from archeological research to suggest that these communities had a strong relationship to local wetlands. Several built structures like channels and planting ridges have been linked to agricultural practices, while the presence of monoliths indicate the cultural dimension of these spaces that might be related to astronomy or territorial ordinance (Bernal, 1990; Boada, 2006; Villa, 2012). The Jaboque wetland in Engativa bears these marks of ancestral memory, as well as a rich biodiversity. The understanding of the cultural and environmental importance of these space has inspired local imaginaries that attempt to defend and protect it (Peña, 2012).

In March 2017 the EAAB contracted a consultancy for the “Detail design of architectural, urbanistic and landscape components of the lower third of the Jaboque wetland with a participatory approach”. This was part of the general city project for the construction of three environmental corridors surrounding three main water bodies in Bogotá, two of them in Engativa. The contract justification (EAAB, 2017) stated that the administration had undertaken multiple actions to recover the wetland and “consolidate it as a space that serves community and that is in turn protected and recuperated by it”. Due to its strategic location in the proximity of a park, the Juan Amarillo wetland and the Bogotá river, the Jaboque wetland was described as “a focal point, relevant in the generation of new urban spaces that allow for the integration of all these ecosystems” (p.4). The document describes previous work that had been done since the 90s in order to promote a sustainable use. It describes the banks of water bodies as public space and states the need to give continuity to the work that had been done in the upper third, completing the wetland’s perimeter so that the community could make use of it.

According to the document, the lower third of the wetland was a physical barrier that generated improper activities in the ecosystem like substance abuse, presence of homeless people and debris disposal. Since the wetland is embedded in urban land, generating public use of it was paramount to integrate the community in its protection. The main goal of the project was to create continuity with the interventions in the upper third and to provide the community with new opportunities to transport themselves by walking or biking and to create a public space that would enable new social dynamics. These types of initiatives had a specific reasoning behind them. In 2015 a national decree declared that the acceptable area of public space per inhabitant was 15 square meters per the decree 1077 of the Housing, City and Territory Ministry (2015). According to the district’s public space observatory, in 2016 the average for Bogotá was 4,5 square meters (DADEP, 2016). Thus, the 2016-2019 administration formulated part of its development plan based on the concept of urban democracy, that emphasized public space as “a right for everyone”. In this vision, the underutilized, insecure wetland would become a public linear park meant to improve the lives of all citizens and the image of Bogotá.

When the contract for the design work of the environmental corridor was signed in 2017, social organizations sounded the alarms. Times before, the EAAB company had intervened the wetlands in the district and, according to the citizens, they had harmed the ecosystem and thus, their trust in the company. In agreement with these appreciations, the Environmental Management plan for Jaboque, adopted in 2017 states that: “Previous civil work undertaken in the wetland has not been found to have any environmental function [...] we therefore estimate that the goal of these perimetral canals is not to control flooding, as it has been argued occasionally by the Sewage and Water Company, but to adequate new sites of the wetland for urban development purposes” (PMA, p. 482). As a consequence, when



the local organizations and the citizens were finally presented with the architectural and landscape design work that had been commissioned in March 2017, there were several disagreements amongst the parts. On February 18th, 2018 the Sewage and Water company organized a fair in Engativa's foundational plaza. They set up tents with information about their work, the wetland and the environmental corridor project. In the first tent, one of the staff members received people with a sign-up sheet to register participation.

The second tent displayed a large scale poster with an aerial photograph of the wetland that was marked with the different interventions planned. Those included two environmental classrooms, a plant nursery, a composting area and a "palaphitic path" for bicycles and pedestrians. This was the first time that the community saw the designs. People gathered around the tent, were two architects sat down with a design book that detailed the project. As they started to explain their work, a question emerged: "Why is this the first time the community hears about this project?". The architects explained the participatory approach they had taken to the design and the EAAB claimed that they had the attendance sheets to all the socialization events they had done in Engativa. Some people started arguing with the architects and the staff, while others questioned people's complaints and their interruption of the event. The architects' frustration was evident. After all, and as the citizens pointed out later, they were only consultants doing their job.

One of the citizens raised his voice: "I have been trying for almost an hour to hear from these group of professionals about the project, but the community has not allowed that. You've been complaining the whole time that you have no idea what these designs are about so...", an older woman interrupted: "Well, I have no idea about drawing or architecture. But I live here and I know what I feel and what I see that is happening in the wetland". Eventually, the fair ended with a commitment: the Water and Sewage company, the architects and the consultants in charge of the social management of the project agreed to explain the designs on site during a walk in the wetland that would take place one week after. They also agreed to send the design via email to anyone who requested them for previous examination, since the citizens wanted to know exactly what materials would be used and where each intervention would be made.



**Figure 4:** Render of the Jaboque Project. [Render: EAAB website, December 2019]

One week after, the scheduled walk was a disaster. Other citizens that had not been in the plaza before joined in, questioning the whole project in a heated discussion. People started leaving and the space dissolved, leaving doubts and discomfort. The civil works were contracted in December 2018 and the construction began in April 2019. Around that time, a judge demanded that the decree that allowed hard civil work to be built inside wetland area to be suspended. The construction continued while the local administration appealed the decision, which was then ratified in June 2019 by a municipal court. The court argued that the local administration had "omitted the duty to inform the community about the scope of the norm". The administration claimed that they had published the decree on their website. Finally, the court reminded the administration that their duty is to "facilitate and enable citizen's participation in the decisions taken, even more as wetlands are ecosystems granted with special protection with policies that have been constructed with citizens' participation" (Poso, 2019). The momentary relief felt by the local environmental organizations went away quickly when the administration claimed that the tribunal's decision had no effect on the projects that were already moving forward. Despite all the efforts, the projects in the wetlands continued.

### 3.0 BECOMING POLITICAL

An obvious identity that takes form is the division between those who agree with the project and those who don't. However, these identities emerge as a forced product of the intervention, that acts as a polarizing entity forcing people to take a stance. Within the contesting group of people a variety of positions can be found; these nuances are evidenced at the socialization of the project. Part of the public agrees that some kind of intervention should be made but disagree with the methods used by the administration, while a minority think that the wetland should be left alone. Part of the people involved hold a utilitarian conception of urban ecosystems (they increase property value, they will create opportunities for enjoyment) while others are concerned about non-human life and interdependencies. All these groups

of people make up the public in the issue, in Latour's terms, even if an incomplete one, given that the groups did not include all the concerned groups of people. For example, people from the northern part of the wetland did not attend the event in the plaza, which is located south of the wetland.

In Mouffe's framework, the issue becomes political as stances are forced by the imminence of the project, however, it is important to distinguish between actors who will remain with this particular issue regardless of contingent conditions like employment or administrative period—local citizens and environmentalists—and actors that represent the hegemonic order out of duty—architects, city officers and engineers. There are also a variety of knowledges related to the wetland and the city at play, which include scientific knowledge, technical-normative knowledge and situated knowledge. Additionally, attitudes towards the institutional actors include distrust, apathy and respect for authority, while attitudes towards socio-environmental organizations range from capricious, inflexible or disruptive to conscious and committed. These are all factors that contribute to the formation of identities around the issue and that generate particular requirements for the dialogue. The details of how democratic debates take place matter (Haraway, 2016). What this means is that the materiality of the issue bears great relevance to how it plays out. In the setting described above, the fair is staged for the performance of a certain notion of participation. Ideally people would learn about the wetland in the first tent, observe the design proposed in the second tent, go on to the third tent and move on fluently. However, when dissenting voices engage in the activity and question this interpretation of participation, the flow is disrupted and the issue is redefined from the design details of a project to the design of spaces of participation.

The materiality of the design project itself becomes relevant as well. For the citizens, the digital images bare little significance, especially since the validity of these types of imaging had been repeatedly contested due to the Mayor's insistent use of them. For the environmental organizations, statements in the designer's brief like "low impact structures" raised a lot of questions. The materials and the ways in which the structures would be built did not depend on the designers themselves but on the contractors that would be hired to build the project later. However, previous interventions in the wasteland and a lack of trust in the capacity of the EAAB and the contractors to be able to care for the wetland's ecosystems led environmentalists to question the project in detail. In their daily life, socioenvironmental organizations legitimize their voice through the work they perform in their area of influence and within the city's network of social and environmental movements. Some of their means of action have been outlined by Quimbayo-Ruiz. (Quimbayo Ruiz, 2018).

Quimbayo uses this framework to argue that advocacy for nature became institutionalized in Bogota through a series of achievements of the social and environmental movements which are crystallized into legal and institutional mechanisms intended to increase citizen's participation in environmental decision-making. However, the existence of these instruments does not guarantee real participation since the details of how that participation occurs and its actual scope depends on the will of each actor in charge of the execution. In the case of the Jaboque project, citizens and organizations complained that participation was instrumentalized by the EAAB and the local administration. The participatory sessions—one of the citizens said—were actually socializations that did not take into account people's opinions when they disagreed with the projects. However, the legal and institutional instruments do provide a basis on which citizens get to make demands on account of previously won battles for participation. Again in these cases, what is contested is the interpretation of what participation means. While the administration and the EAAB interpret participation as one-way communication (posting information on the website) or an incomplete dialogue (providing information, gathering suggestions but disregarding disagreeing remarks), socio-environmental organizations interpret participation as actionable dialogue that has some effect in the decisions made about them and the issues they are concerned about. Because of this perceived unreliability of institutionalized spaces of participation, the last row in table 1 gathers particular importance. It is in these activities that socioenvironmental organizations in Bogota challenge a created difference that drove the development of the city: the modern divide between people and nature, which posed the control of nature by civilization as a building block for the modern city (Gallini & Osorio, 2015). Challenging this hegemonic, monocultural logic (Santos, 2012) visibilizes its alternatives and engages new publics (indifferent citizens, nature) in the issue. Organizations try to enact alternative forms of urbanism at the local scale by promoting a different form of relating to the ecological structure and shaping new imaginaries of what urban development might be like.

These actions constitute the counterpart of the digital images used by the local administration. They embody a particular vision of the city, however, unlike the rendered images, they are not intended to be a complete vision but one in construction that only signals at possible directions and invites engagement. The eco-villages, urban gardens, murals and environmental interpretation paths that are designed and built in an ongoing basis, act as partial images of what an alternative future might be like. Even though they bear little global relevance compared to the digital images made by architects and engineers and widely distributed by the administration, they constitute

## CONCLUSION

Urban environmental movements in Bogota emerge from struggles about the city's future and the model that drives its development. Concerned citizens and socio-environmental organizations make up a public that questions the drivers of development. This translates into a challenge to the hegemonic interpretation, in Mouffe's agonistic politics framework, of "urban wellbeing". In response, they enact alternative urban models that struggle to become viable alternatives, as they are made invisible and unfeasible by the hegemonic monocultural rationality (Santos, 2012). A

relevant question is how an agonistic model of democracy would deal with the politics of objects and representation that also constitute the dimension of the political. Different scales shape different issues and thus, new identities around it, which are not necessarily engaged in coherent dualistic antagonism as Mouffe suggests is a necessary condition of the political. Paying attention to how these scales are brought into focus (Barad, 2007) and to the relations between human and non-human entities around the issue might illuminate other possibilities for ways in which the political occurs beyond antagonism. Moreover, the case presented illustrates how a certain translation becomes necessary for the possibility of democracy (Santos, 2012). This translation must go beyond words and into the realm of objects, a task for which designers might be well suited. Finally, we think that this account provides material to think about the processes and objects of design and their relation to the world (or worlds) in which they exist.

## REFERENCES

- Agacinski, S. (2001). *Public space and democracy*. Marcel Hénaff and Tracy B. Strong, editors (M. Hénaff, Ed.). University of Minnesota Press.
- Altürk, E. (2008). Architectural representation as a medium of critical agencies. *The Journal of Architecture*, 13(2), 133–152. <https://doi.org/10.1080/13602360802023989>
- Avril, E., & Neem, J. N. (2014). *Democracy, Participation and Contestation: Civil society, governance and the future of liberal democracy*. Routledge.
- Barad, K. M. (2007). *Meeting the universe halfway: Quantum physics and the entanglement of matter and meaning* /. Duke University Press.
- Bellacasa, María Puig de la. (2017). *Matters of Care* (3rd ed. edition). Univ Of Minnesota Press.
- Bernal, F. (1990). Investigaciones arqueológicas en el antiguo cacicazgo de bogotá(funza, cundinamarca). *Boletín de Arqueología*, 5(3), 31–48. Scopus.
- Boada, A. M. (2006). Patrones de asentamiento regional y sistemas de agricultura intensiva en Cota y Suba, Sabana de Bogotá (Colombia) Fund. *Investig. Arqueol. Nacionales, Banco de La República*. 181p.
- Cruz, C. A., & Salazar, P. (2017). MESA DE CERROS ORIENTALES: Acción colectiva en los bordes de lo urbano-rural en la ciudad de Bogotá, D.C. *Ciencia & Trópico*, 41(1). <https://fundaj.emnuvens.com.br/CIC/article/view/1619>
- DADEP. (2016). Reporte técnico de indicadores de espacio público. Departamento Administrativo de la Defensoría del Espacio Público. Bogotá.
- De la Bellacasa, María Puig. (2011). Matters of care in technoscience: Assembling neglected things. *Social Studies of Science*, 41(1), 85–106. <https://doi.org/10.1177/0306312710380301>
- EAAB. (2017, February 14) Solicitud de un trámite de contratación. "Consultoría" 25100-2017-69. Empresa de Acueducto Agua y Alcantarillado de Bogotá.
- El Tiempo. (2018, July 22). Lagos de Torca, desarrollo urbano en el norte de Bogotá. Retrieved from: <https://www.eltiempo.com/bogota/como-sera-el-proyecto-lagos-de-torca-de-bogota-246476>
- FLIP. (2018, June 9). *Pauta Visible*. <https://pautavisible.org/mapa/3261>
- Gallini, S., & Osorio, C. C. (2015). Modernity and the Silencing of Nature in Nineteenth-Century Maps of Bogotá. *Journal of Latin American Geography*, 14(3), 91–125. <https://doi.org/10.1353/lag.2015.0028>
- Glaeser, E. L. (2011). *Triumph of the city: How our greatest invention makes us richer, smarter, greener, healthier, and happier* /. Penguin Press.
- Goldman, M. R. (2014). "Development and the city": Essay written for cities of the global south reader (2015). *Cities of the Global South Reader*, 54–65.
- Haraway, D. J. (2016). *Staying with the trouble: Making kin in the Chthulucene*. Duke University Press.
- Harvey, D. (2012). *Rebel Cities: From the Right to the City to the Urban Revolution*. Verso Books.
- Hsueh, C.-L., Chu Hoi Shan, P., & McGrath, B. (2016). Rendering the Social in the Architectural Scene: Digital Representation and Social Inclusion on Architectural Design, Thinking, and Education. *Architecture MPS*. <https://doi.org/10.14324/111.444.amps.2016v8i4.001>
- Julio, M. Á. and A. Hernández (eds.). 2014. *Territorios ambientales de Bogotá. Historias de acción colectiva*. Bogotá: Secretaría Distrital de Ambiente. Centro Interdisciplinario de Estudios sobre el Desarrollo de la Universidad de Los Andes.
- Latour, B. (2014). What Is the Style of Matters of Concern? In N. Gaskill & A. J. Nocek (Eds.), *The Lure of Whitehead* (pp. 92–126). University of Minnesota Press. <https://doi.org/10.5749/minnesota/9780816679959.003.0004>
- Latour, B., & Weibel, P. (Eds.). (2005). *Making things public: Atmospheres of democracy*. MIT Press ; ZKM/Center for Art and Media in Karlsruhe.
- Lefebvre, H. (1991). *The production of space* /. Blackwell.
- Londoño, B. (2008). Las organizaciones no gubernamentales ambientales colombianas y su ejercicio de las herramientas de participación institucionalizada. In M. Rodríguez Becerra (Ed.), *Gobernabilidad, Instituciones y medio ambiente en Colombia* (1. ed). Foro Nacional Ambiental.
- Ministerio de Vivienda, Ciudad y Territorio (2015, May). Decreto Número 1077 de 2015. Retrieved from: <http://www.minvivienda.gov.co/NormativaInstitucional/1077%20-%202015.pdf>
- Mirafteb, F. (2017). Insurgent practices and decolonization of future(s). In *Routledge Handbook of Planning Theory*. Routledge.
- Mouffe, C. (2013). *Agonistics: Thinking The World Politically* (1 edition). Verso.
- Peña, Y. T. H. (2012). *El conocimiento de imaginarios sociales como base para la gestión del desarrollo territorial urbano: Estudio de caso en la localidad de Engativá*. 11.
- Poso, A. (2019, June 12). Reafirman la suspensión de decreto 565 de 2017 sobre humedales de Bogotá. Retrieved January 21, 2020, from <https://www.asuntoslegales.com.co/actualidad/reafirman-la-suspension-de-decreto-565-de-2017-sobre-humedales-de-bogota-2873021>
- Quimbayo Ruiz, G. A. (2018). People and urban nature: The environmentalization of social movements in Bogotá. *Journal of Political Ecology*, 25(1), 525. <https://doi.org/10.2458/v25i1.23096>
- Ruiz, G. A. Q. (2014). Movimientos sociales, políticas y conflictos ambientales en la construcción de ciudad: El caso de Bogotá. *Ecología Política*, 47, 104–107. JSTOR.
- Santos, B. de S. (2012). Public Sphere and Epistemologies of the South. *Africa Development*, 1, 26.
- Soto, H. de. (2000). *The mystery of capital: Why capitalism triumphs in the West and fails everywhere else* /. Basic Books.
- Swati Chattopadhyay. (2012). Architectural Representations, Changing Technologies, and Conceptual Extensions. *Journal of the Society of Architectural Historians*, 71(3), 270–272. <https://doi.org/10.1525/jsah.2012.71.3.270>
- Tran O'Leary, J., Zewde, S., Mankoff, J., & Rosner, D. K. (2019). Who Gets to Future?: Race, Representation, and Design Methods in Africatown. *Proceedings of the 2019 CHI Conference on Human Factors in Computing Systems - CHI '19*, 1–13. <https://doi.org/10.1145/3290605.3300791>
- Villa, H. M. S. (2012). Importancia histórica y cultural de los humedales del borde norte de Bogotá (Colombia). *Revista UDCA Actualidad & Divulgación Científica*, 15(1), 167–180.
- Woldeamanuel, M. ( 1 ), & Palma, J. ( 2 ). (2015). *Are you really listening to me?: Planning with the community in urban revitalization projects*. Taylor and Francis Inc.

# On Conflicting Priorities Within Digital Models of Urban Form

Mike Christenson<sup>1</sup>

<sup>1</sup>University of Minnesota, Minneapolis, MN

**ABSTRACT:** As part of the larger project of architectural epistemology, this work seeks to develop a method for digitally modeling urban form emphasizing conflicting priorities, deviations, and shifts as characteristic. In particular, this work examines how representations can exist as registers of difference. The skyway system in downtown St. Paul, Minnesota is examined as a test case.

**KEYWORDS:** Digital modeling, urban morphology, parametric modeling, skyways, architectural epistemology

## 1.0 PARAMETRIC READING

Considered generally, parametric modeling possesses three important characteristics: first, it is algorithmically driven (e. g., by means of a script). Second, its algorithms or rules are responsive to variable input from a multiplicity of sources (i. e., parameters). Third – and as a consequence of both of the first two characteristics – it is capable of generating arbitrarily large, dense, and complex models. Leveraging these characteristics, parametric modeling is positioned in this work as a mode of reading existing urban form, an approach termed *parametric reading*.

Parametric reading is related to but distinct from the use of parametric modeling as a design tool. Jabi et al (2017, 98) remark that “parametric design systems ... establish higher-level abstracted design concepts through the linking of parameters,” which is equally true of parametric reading. Both parametric design and parametric reading call for “a shift of focus from achieving a high fidelity in the representation of the appearance of a design to that of achieving a high fidelity in the representation of its internal logic” (Jabi et al 2017, 99). This characterization of parametric reading is consistent with what may be called an *assumption of tactical identity*, which holds that while the aims of architectural analysis and design may differ, their tactics are the same, insofar as both depend on the persistent, iterative production of drawings, models, and photographs (Christenson 2008, 6). To the extent that parametric reading relies on the tools of parametric design without necessarily sharing its aims, it can be approached *tactically* in a way similar to parametric design. That is to say, the same set of tools can be deployed in both parametric design and parametric reading, and the decisions concerning how to use the tools of parametric modeling at a tactical level can be guided by similar considerations in either case. This is true despite the difference in aims: i. e., while parametric *design* is aimed at the production of new designs (for buildings, installations, etc.), parametric *reading* aims at the production of analytical representations (e. g., maps, diagrams, models) without explicitly proposing new designs. Parametric reading is therefore less concerned with *form-generative* rules than it is with *form-reading* rules.

Parametric reading requires parametric modeling tools to be brought to bear within an existing-environment model. Thus, parametric reading assumes that an existing environment (e. g., a building or a district) is digitally modeled to an arbitrary degree of accuracy. The existing digital model need not be a parametric model; it is sufficient that the model be *legible* by parametric modeling software. For example, an existing environment could be modeled using standard tools in Rhino, and Grasshopper could be used as a parametric reading tool.

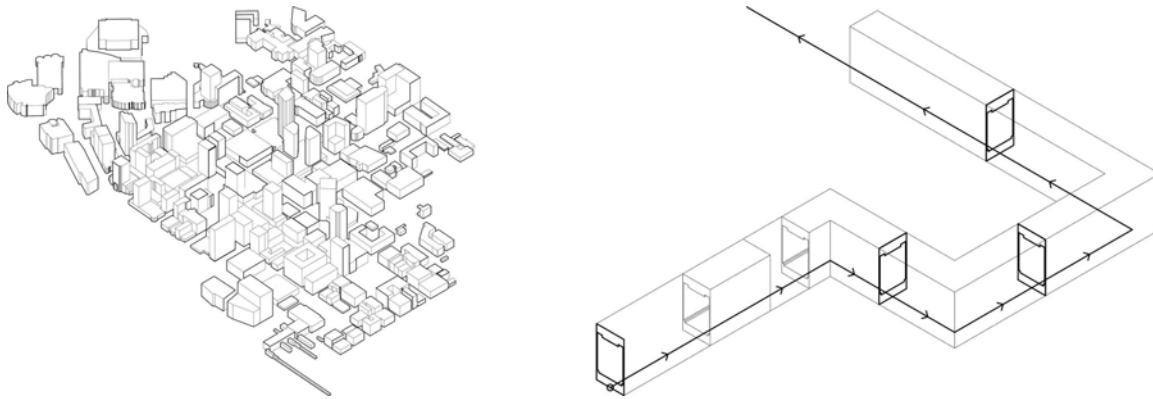
The results of applying parametric reading within a digital model can be understood as the discrete (point-by-point, or plane-by-plane) representation of large-scale phenomena or structures. In parametric reading, these representations emerge through the act of implementing the rule-based practices characteristic of parametric modeling within a model of an existing building or district. If successful, parametric reading reveals patterns leading to inferences about the value and significance of features within the existing modeled environment. In particular, the fluidity of parametric reading is brought to bear against existing environments in their solidity, immovability, and impenetrability.

A simple example illustrates fundamental concepts of parametric reading. *Serial sections* of a digital model may be driven by a small set of rules (e. g., repeatedly calculating the intersection between the digital model and a vertical plane as the plane shifts across the model). The section-cutting parameters – the direction of the section cut, the location of the cutting plane, etc. – can be modified according to variable input. An arbitrary number of parametrically-created sets of serial sections can be produced, each capable of foregrounding particular readings of the given model.

## 2.0 ARCHITECTURE AS PARAMETRIC READING

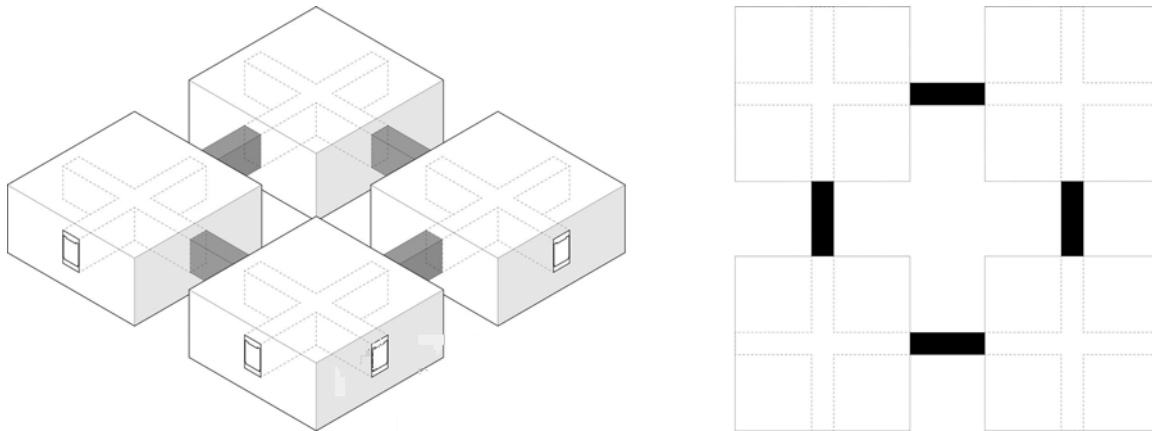
Parametric reading constitutes a unique mode of analysis with potentially wide application. The approach assumes a deeper level of architectural significance when *built works* are seen as the consequence of parametrically reading existing conditions. As an example, consider elevated pedestrian skyway systems, typical of those found in several predominantly cold-climate American cities consisting of grade-separated internalized corridors and bridges enabling pedestrian movement within an urban context. Such systems enable movement which, relative to movement on the ground, is both predictable, in that it is constrained to operate in very particular ways, and frictionless, in that it is designed to navigate around obstacles. Skyway systems of this kind are designed to support a convenient form of pedestrian navigation, connecting parking ramps, hotels, retail stores, and banks, becoming a means to the efficient pursuit of present-day urban existence (Christenson and Kindell 2021).

Skyway systems are valued both for their practical efficiency and conceptual clarity. At a system-wide scale, concepts like Calgary's "+15" are designed to emphasize the idea of an elevated grid, i. e., a system that both repeats the city's grid and rises above it, promoting a frictionless navigation system for pedestrians. Yet, despite its claims to efficiency and clarity, the skyway is simultaneously esoteric and opaque. Jacob (1985) has described the skyway as an "immense, labyrinthine building at the second story," only momentarily visible from the exterior as it leaps across the void of the street. Boddy (1992) raises the possibility that the skyway is not itself a constituent part of the city but rather an analogue or substitute for an authentic urban experience. Skyways, for Boddy, "provide a filtered version of the experience of cities, a simulation of urbanity" (Boddy 1992, 124). Following Boddy's implicit provocation, we can examine how the skyway provides a *filtered* version of experience by functioning as a parametric reading device.



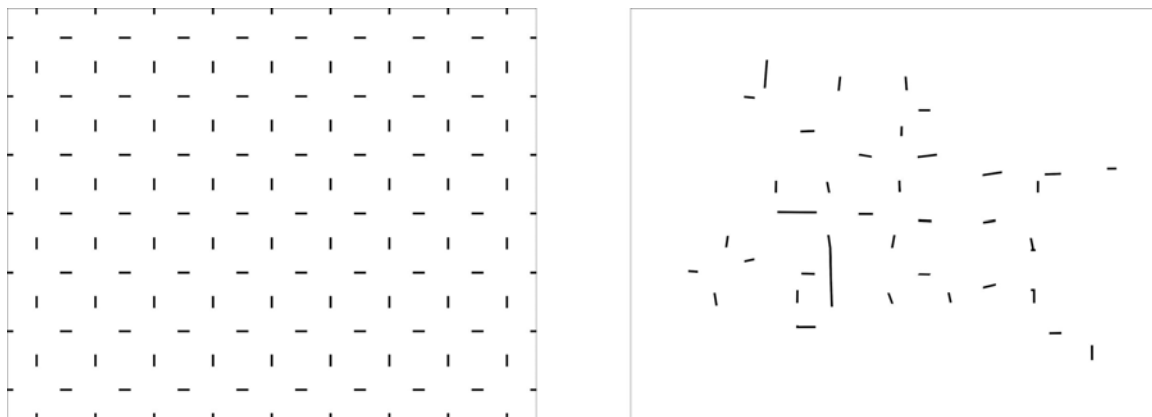
**Figure 1:** Left: digital model of downtown St. Paul. Source: (Christenson and Kindell, 2021). Right: parametric model of the skyway. Source: by author.

Consider as an example the skyway system in downtown St. Paul, Minnesota (USA). Here, "all the bridges look nearly alike as their prototype was developed by the city, and they are meant to be seen as a single concept" (Jacob 1995, 28). Suppose that we have a digital model of downtown St. Paul which we wish to read parametrically (Figure 1, left). One approach would be to define a parametrically-driven representation of the skyway as a *uniform cross-section extruded along one or more variable paths* (Figure 1, right). The essential behavior of this model reflects the impulse of skyway systems to connect disparate points and also to enclose an elevated path in a consistent manner, providing a predictable, frictionless navigation through an urban context. As an initial iteration, we can test this behavior by implementing the parametric representation of the skyway within an otherwise featureless digital model of regular, square building masses separated by a grid of streets (Figure 2, left). The initial implementation acknowledges two distinct conditions: the skyway can be either *extruded within a building mass* or *extruded outside of the building mass*. In the latter case, the extrusion can be marked as a bridge or crossing (Figure 2, right).



**Figure 2:** Left: Initial implementation within an otherwise featureless digital model of regular, square building masses. Source: by author. Right: Plan diagram of initial implementation; bridge locations marked. Source: by author.

Suppose further that this initial implementation is extended throughout a model consisting of hypothesized urban blocks, approximating the size and position of blocks in downtown St. Paul, and that the bridges are mapped in the same manner as shown in Figure 2 (right). The resulting diagram is referred to as  $A_0$  (Figure 3, left). For comparison with  $A_0$ , a model of the downtown St. Paul skyway system at the same scale is marked in the same manner (with the skyway bridges highlighted) to produce  $A_1$  (Figure 3, right).

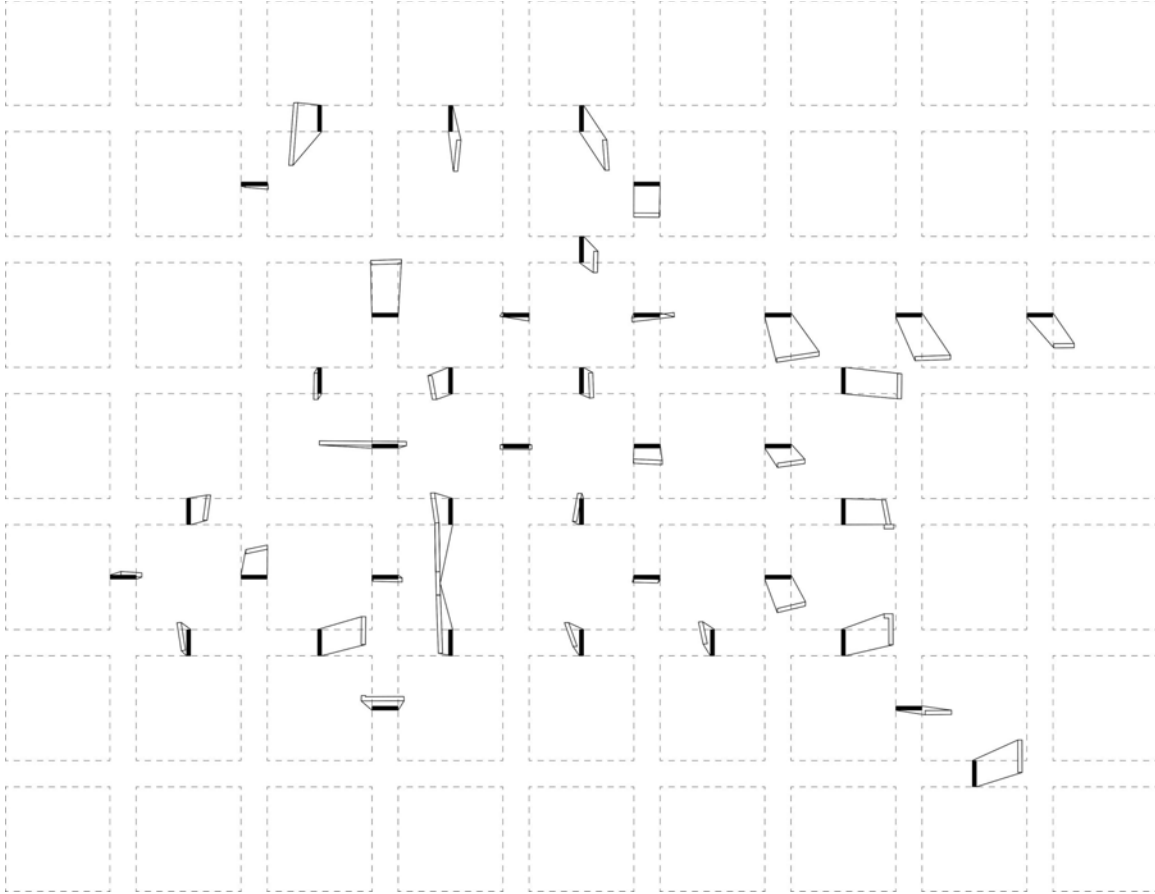


**Figure 3:** Left:  $A_0$ , an implementation of skyway model within a hypothesized grid of urban blocks with bridge locations marked. Source: by author. Right:  $A_1$ , showing bridge locations marked within a digital model of the St. Paul skyway system. Source: by author.

The bridge locations in  $A_1$  can be said to correspond to *perturbed locations* of bridges shown in  $A_0$ . Another way to say this is that  $A_1$ , representing the actual locations of skyway bridges, is the presumed result of iterating the parametric skyway model within the model of the pre-existing built environment corresponding to downtown St. Paul. Seen in this way,  $A_1$  represents the result of *forces* present within the existing built environment capable of disturbing or inflecting what is otherwise a uniform, hypothesized condition registered by  $A_0$ . These forces could correspond, for example, to different degrees of permeability within existing buildings, such as the difference between structural components and nonstructural components. A skyway bridge that might otherwise be designed to intersect an existing building at its midblock point might deviate from its presumed course because of the presence of structural element such as a column. Or, a skyway bridge might deviate from its otherwise uninflected course due to the presence of a pre-existing quasi-public space such as an atrium or elevator lobby, i. e., a space that can be incorporated within the skyway system and repurposed as an access node into the skyway. Or, on a larger scale, bridges could deviate from a regular, uninflected grid as a reflection of downtown St. Paul's street grid, which itself varies from a uniformly orthogonal grid. These deviations, considered collectively, contribute to the sense of what Jacob called an "immense, labyrinthine building" inserted within the pre-existing urban fabric. In short, Jacob's labyrinth is a *reading* of the pre-existing urban fabric. It reveals peculiar attributes of its context through deviations from what would otherwise be uninterrupted and unvarying trajectories.



Beyond simply acknowledging that the deviations from a hypothesized condition could represent existing conditions within the city, the *mapping of deviations* becomes an important component of parametric reading, specifically as part of a process of identifying patterns that could be significant for making inferences about the city and its histories. With respect to  $A_0$  and  $A_1$ , one possibility is to map deviations as *shifts* or *translations*, such that the bridges as *built* are related to the positions of the bridges as *hypothesized*.



**Figure 4:** Shifts in bridge locations between  $A_0$  and  $A_1$ . Source: by author.

Figure 4 depicts the bridge locations as hypothesized and mapped in  $A_0$  (shown as solid) and the bridge locations as built and mapped in  $A_1$  (shown as open), with connecting lines indicating the divergences between the hypothesized locations and the built locations. The connecting lines may be said to reflect precisely the forces capable of disturbing  $A_0$  into  $A_1$ . Figure 4, as a map of those differences, demonstrates that parametric reading is capable of registering the shifts away from a hypothesized ideal condition. In the case of St. Paul, that hypothesized ideal condition (as concretized in  $A_0$ ) consists of a grid of equally-sized, square city blocks, approximating St. Paul's block sizes, and with skyway bridges crossing at the midpoints of blocks.

Parenthetically, we note that  $A_0$  as well as  $A_1$  represent hypothesized conditions assuming different degrees of abstraction. The abstracted street grid of  $A_0$  is no more specific to downtown St. Paul than it is to downtown Minneapolis (or for that matter, to downtown Calgary or to downtown Belo Horizonte): it assumes an "ideal condition" of orthogonally gridded streets. Similarly, the midblock skyways in  $A_0$  represent an abstraction not specific to any particular city.  $A_1$ , while representing St. Paul, is still an abstraction, and like any abstraction it simplifies and highlights aspects of the observable built condition.

Suppose that instead of the condition mapped in  $A_0$ , a different ideal condition is hypothesized and a new map drawn. A newly hypothesized condition could be based on any one or more of several different possible assumptions, e. g., hypothesizing different sizes and shapes of city blocks, or hypothesizing different locations for skyway bridges. Consider the possibility that the hypothesized street grid is rotated at an arbitrary angle different to that assumed for  $A_0$ , while holding all other conditions constant. This new map is called  $A_0'$  (Figure 5, right).

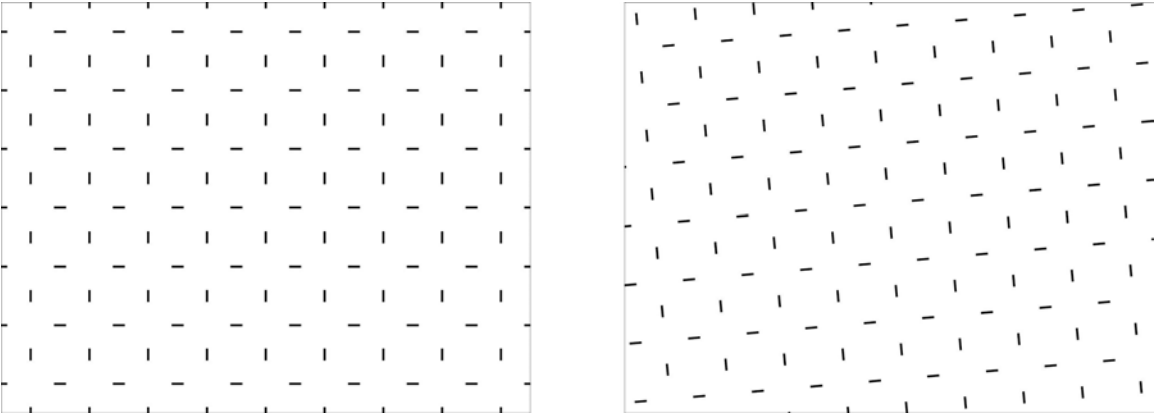


Figure 5:  $A_0$  and  $A_0'$ . Source: by author.

Just as  $A_0$  was tested against  $A_1$  (bridge locations “as built”), so too can the newly hypothesized  $A_0'$  be tested against  $A_1$ . As in the earlier case, the relationship between  $A_0'$  and  $A_1$  can be mapped and depicted using connecting lines to indicate divergences between the hypothesized locations and the built locations (Figure 6).

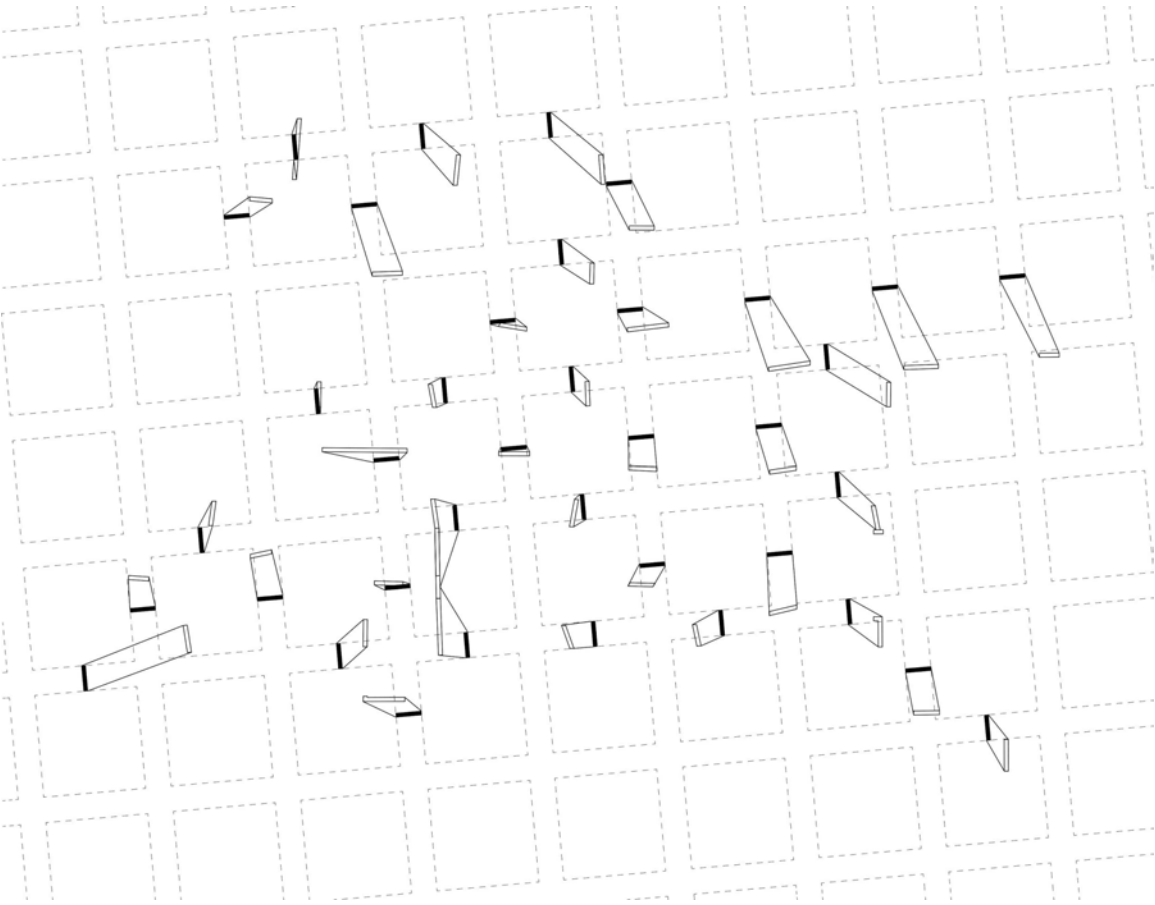


Figure 6: Shifts in bridge locations between  $A_0'$  and  $A_1$ . Source: by author.

### 3.0 DISCUSSION

Both  $A_0$  (Figure 5, left) and  $A_0'$  (Figure 5, right) can be tested against  $A_1$  (Figure 4, Figure 6). Collectively, the maps and their comparisons provide two distinct ways of understanding deviations from an assumed ideal condition, although the assumed ideal condition is different in each case (i. e., either  $A_0$  or  $A_0'$ ). Indeed, there is no obvious limit on the number or kind of ideal conditions that could be assumed in comparisons of this kind. For example, just as  $A_0'$  is hypothesized in this paper to allow for variations in the rotation of blocks, conditions  $A_0''$ ,  $A_0'''$ , etc., could be hypothesized to allow for variations in the shape of blocks, variations in the size of blocks, variations in the widths of the streets, or any other number of possible variations and combinations thereof. At a metalevel, the assumption of a regular grid could easily be called into question, and variations in the base pattern of streets could be tested (e. g., varying the size and proportion of blocks, or varying the otherwise uniform width of streets, or even replacing rectangular grids with other patterns).

Each of these criteria and others could be implemented in the same manner as described in this paper – that is, parametrically modeled, tested against  $A_1$ , and mapped so as to identify deviations from a presumed ideal condition. This in turn implies that there is no obvious prior limit on the type or configuration of ideal condition that may be reasonably hypothesized from the observed condition. At a minimum, hypothesizing ideal conditions ( $A_0''$ , etc.) involves nothing more than arbitrarily modifying geometric parameters such as scale and rotation. Yet, we might nevertheless expect that the repeated comparison of several test hypotheses against  $A_1$  could reveal stable metrics or *invariants*. In particular, suppose that a study of deviation from ideal conditions (Figure 4, Figure 6) was quantified in some way, i. e., that one or metrics could be established to encode in a consistent way the amount or degree of deviation between  $A_1$  and a hypothesized ideal condition. Supposing that a *deviation metric* could be established, would it necessarily suggest that an *optimization process* could exist – that is, a method for hypothesizing an ideal condition  $A_{(n)}$  that leads to a demonstrably minimum deviation metric?

Acknowledging that such an optimization process may be possible is not necessarily to admit its relevance to revealing characteristic qualities of the city itself. In particular, an optimization process could not be guaranteed to suggest specific *reasons* for observed differences. Maps such as Figure 4 and Figure 6, although they highlight deviations between different forms of representation, do not make clear how that deviation arises from significant, meaningful conditions in the city (as distinct from happenstance consequence of misalignment between  $A_0$  and  $A_1$ ). It should at least be apparent that optimizing a deviation metric deriving from bridge *locations* could lead to a different result than optimizing a metric deriving from bridge *orientations*, or bridge intersections, or any other characteristic of the map. In this light, it seems that the value of hypothesizing any particular ideal condition is that of metaphorically staking a point within the field, a stable reference capable of being brought into relation with other, similarly-staked points. Comparisons such as shown in Figures 4 and 6 do not reveal in any obvious way the *reason* for observed deviations but rather simply foreground their presence.

Of course, it is a persistent truth that cities are always the consequence of decisions made over extended time by diverse, legitimate, conflicting constituencies, with apparently incompatible yet co-existent priorities of their own. The totality of city-shaping decisions reveals the presence of these constituencies, in both built and mapped form. Mapping deviations from a hypothesized ideal condition is simply one way of making these always-present conflicts visible for study. Considered collectively, deviations from a hypothesized ideal condition are a kind of *trace* of historical processes. In noting a similar characteristic of urban street grids, Hillier (1999) writes “The urban grid is not just a configurational shell for human activity. It is already alive with the history of human activity.” In their own way, skyways serve a similar capacity. Rather than providing “a simulation of urbanity,” as Boddy claims, skyways point to exactly that which is characteristic of cities, i. e., that urban experience is *always* filtered. In the sense of Baudrillard (1994), skyways contribute to the *simulacrum* – reminding us that in the contemporary city, it may no longer be possible to speak of an original condition.

### 4.0 SUMMARY AND FUTURE WORK

This paper proposes the possibility of *parametric reading*, a method that is both distinct from and related to *parametric design*. Parametric reading is consistent with the *assumption of tactical identity*, i. e., that the tactics of parametric reading and parametric design are identical even as their strategic aims differ: specifically, both parametric reading and parametric design are dependent on the implementation of algorithms or rules and on those rules' capability to respond to variable (parametric) input, combining to produce large-scale instantiations. Like other approaches within urban and architectural representation, parametric reading is capable of uniquely revealing patterns which are in turn suggestive of patterns in the city. These patterns may not be obviously apparent under other approaches. Beyond the implications of parametric reading as a pattern-finding approach, this work also considers the possibility of *architecture itself* operating as a parametric reading device, as discussed with respect to the St. Paul skyway system.

Questions remain for investigation, and the relevance of parametric reading as a tool for understanding other built interventions needs to be further tested. What are presented here in the form of hypothesized ideal conditions (Figure 5) are diagrams that could reasonably lay claim to representing street grids in many cities. Diagrams like Figure 3 (right) are specific to conditions, e. g., downtown St. Paul; diagrams like this but specific to other cities could be substituted within the process, opening the method to comparative analysis of similar systems elsewhere (e. g., Minneapolis, Fargo, Calgary). Also, this paper has focused on the question of deviations and conflicting priorities by using the location of skyway bridges as a proxy for the larger, more complex skyway system. Other possibilities – such as those mentioned above, including bridge orientations instead of bridge locations, or the vertical deviation of the skyway’s walking surface from an arbitrarily determined horizontal plane – remain to be tested. Most generally, parametric reading requires further testing and implementation across a variety of scales and geometries to better determine its viability as an approach to architectural and urban analysis. Beyond tests of the method as it applies to digital models of architectural and urban form, a larger question asks whether other built interventions could be understood in the same way as the skyway, i. e., as parametric reading devices. Candidate studies would involve large-scale architectural or urban interventions within an existing context, driven by local rules, i. e., interventions with exactly the characteristics of parametric modeling. The urban freeway is a logical candidate for this kind of analysis.

## ACKNOWLEDGEMENTS

The digital model of downtown St. Paul discussed in this project was built by Erin Kindell in collaboration with the paper’s author.

## REFERENCES

- Baudrillard, J. 1994. *Simulacra and simulation*. Translated by Sheila Faria Glaser. Ann Arbor: University of Michigan Press.
- Boddy, T. 1992. “Underground and overhead: Building the analogous city.” In *Variations on a theme park: The new American city and the end of public space*, edited by Michael Sorkin, 123-153. New York: Hill & Wang.
- Christenson, M. 2008. “On dependencies between architecture and media: Considering the remote work.” *Enquiry: The ARCC Journal for Architectural Research* 5 (1): 6-15. <https://www.arcc-journal.org/index.php/arccjournal/article/view/24/23>
- Christenson, M., and E. Kindell. 2021. “The skyway as an inhabitable mode of urban representation.” *Proceedings, 2020 EAAE-ARCC International Conference*.
- Hillier, B. 1999. “The hidden geometry of deformed grids: Or, why Space Syntax works, when it looks as though it shouldn’t.” *Environment and Planning B: Planning and Design* 26 (2): 169-191. <https://doi.org/10.1068/b4125>
- Jabi, W., S. Soe, P. Theobald, R. Aish, and S. Lannon. 2017. “Enhancing parametric design through non-manifold topology.” *Design Studies* 52: 96-114. <https://doi.org/10.1016/j.destud.2017.04.003>
- Jacob, B. 1985. “Architectural form in the urban setting.” *Design Quarterly* 129: 29-31. <https://www.jstor.org/stable/4091139>



# Can Danish Ecovillages Demonstrate a Path to Reduce Domestic Energy Use?

Tersea Moroseos<sup>1</sup>, Toke Haunstrup Christensen<sup>2</sup>

<sup>1</sup>University of Washington, Seattle, WA  
<sup>2</sup>Aalborg University, Copenhagen, Denmark

**ABSTRACT:** Household energy use significantly contributes to global carbon emissions. Despite the urgent need to reduce carbon emissions, domestic energy consumption in Denmark is decreasing at a slow rate. This study explores why top-down policies aimed to reduce domestic energy consumption are producing marginal results. We also contrast this approach with Danish Ecovillages, which our findings suggest use much less energy than conventional housing. We also explore how social norms of energy saving emerge within Danish Ecovillages, and how this might represent a pathway to reduced domestic energy consumption.

This study presents findings from field observations and interviews conducted between September and December 2017 of seven Danish Ecovillages. Observations of social practices and architectural design are discussed. Detailed, self-reported household energy data were also collected from three Ecovillages and compared to a baseline of similar Danish homes. Our findings show a significant reduction in heating and plug load consumption in the Ecovillages. When compared with a typical Danish household, the three Ecovillages used 24% to 73% less energy. This paper finds that the emergence of social norms that promote energy saving everyday practices can partly explain the observed reduction in energy consumption. This paper explores how Danish Ecovillages overcome hurdles faced in mainstream society for developing social norms that reduce energy use, mainly through strengthening social relationships between norm beneficiaries and designing the built environment to align with community values.

**KEYWORDS:** Ecovillage, Social Norms, Domestic Energy Use, Sustainable Housing

## 1.0 INTRODUCTION

Climate change is one of the greatest collective problems, threatening human life with food insecurity, population displacement, sea level rise, extreme weather events, and other devastations (McNutt 2013) (Cook 2016) (Urban 2015) (Nagelkerken and Connel 2015). Despite this, global carbon dioxide emissions, which are the primary cause of climate change, increased in 2018 and 2019 (Jackson, et al. 2018) (IEA 2019). The housing sector worldwide significantly contributes to carbon dioxide emissions, and in Denmark, residential energy use accounts for 30.1% of total energy consumption and 17.5% of carbon dioxide emissions (Danish Energy Agency 2020). This study explores how social norms of energy saving emerge within Danish Ecovillages, and how this might represent a pathway to reduced domestic energy consumption.

In response to the environmental crisis, the concept of ecological modernization theory emerged in the 1980s, to describe the mutual benefit that occurs between economic growth and ecological practice (Murphy 2000) (Christensen, et al. 2007). Ecological modernization is a “top-down” approach that engages institutions that are causing environmental devastation, and insists that the economy and environment can both benefit through the application of better and more resource efficient technologies. Ecological modernization principles guide policy decisions all over the world and have greatly increased the energy efficiency of buildings in Denmark (Jensen and Gram-Hanssen 2008). However, this approach to sustainability has not significantly lowered energy use in the United States or in Denmark because it does not confront ways of life, such as consumerism and quality of life expectations, that consume energy (Christensen, et al. 2007) (Jensen and Gram-Hanssen 2008) (Gram-Hanssen 2013).

Unlike ecological modernization, the Ecovillage movement started with grassroots activism and problem-solving informed by personal experience (Boyer 2018). In Denmark the Ecovillage movement began in the 1980s and emerged from the co-housing movement (Jensen and Gram-Hanssen 2008). These communities vary in size and context, but households typically have separate incomes and maintain their private lives while collectively participating in community activities (Boyer 2014). Like co-housing, most families in Ecovillages have their own private units with bedrooms, kitchen, and bath, and also share a common building with a shared kitchen, dining, laundry facilities, meeting, and working spaces. These communities also cooperatively own land that is used for agricultural production, waste-water treatment, production of energy, or recreation.



## 2.0 ANALYTICAL FRAMING OF STUDY

### 2.1 Ecological modernization and the ecological crisis

Ecological modernization is an approach to sustainability that is directed by information and technology and enforced by rules and regulations. Like many other societal forces, this system guides human behavior “outside” of interpersonal dynamics, and are, as Jensen describes, “a movement away from the basic cultural foundation” (O. M. Jensen 1994). In other words, the rules, regulations, and influences of modern institutions create a framework for human behavior that is separated from a locality. Despite ecological modernization playing a large role in shaping government’s and institution’s response to the ecological crisis, there is much criticisms about its capitalistic orientation, since growth and profit are the ultimate incentives (Ewing 2017). Although government and other institutional agencies worldwide show awareness of the ecological crisis and impacts of carbon dioxide emissions, policy is doing relatively little to address these problems (Saha and Paterson 2008) (Tang, et al. 2010).

Regulating everyday practices that consume energy is difficult with ecological modernization. For example, a Danish study found that when comparing the heat load in homes of identical envelope and heating system, households using the least heat use a third less than the top users (Gram-Hanssen 2013). User behavior can also have a large impact on plug load consumption. The same study found that despite the fact that appliances are becoming more energy efficient, households now own and use more appliances, offsetting the impacts of more efficient technology (Gram-Hanssen 2013). The amount of electricity used per person was also found to decrease as the number of inhabitants in a household increased (Gram-Hanssen 2013). Several socio-technical studies on heat-pump equipment demonstrate that the energy efficiency of heating technologies is offset partially by a change in occupant behavior (Sorrell, John and Sommerville 2009) (Gram-Hanssen, Christensen and Petersen 2012). Cheaper heating costs due to heat-pumps results in increased use for greater thermal comfort, with previous research describing a direct rebound effect of 20% in households (Sorrell, John and Sommerville 2009).

Living with less density in a household, using more appliances, and expecting mechanical systems to provide higher levels of thermal comfort are examples of social practice trends that cannot be easily addressed by ecological modernization. In fact, Princen argues that society’s top-down approach to lowering carbon dioxide emissions through efficiency are not the solution to the ecological crisis, because it “(...) help(s) key actors disguise, displace, and postpone true costs” (Princen 2003). Instead, a reassessment of everyday human behavior is necessary to truly influence the ecological crisis, with social restraint as the key driver (Princen 2003).

The ecological modernization approach to the ecological crisis contrasts from the Ecovillage approach, which is a “movement towards the basic cultural foundation” (O. M. Jensen 1994), driven by locality, human interaction, and relationships. Ecovillages form as a reaction against the alienation and environmental degradation associated with traditional housing models (Sanguinetti 2014). The sociologist Anthony Giddens believes that in an effort to not lead meaningless lives, moral and existential questions are going to start being addressed in social behavior, in a *remoralization* of modern society (Giddens 1990). Ecovillages demonstrate this *remoralization*, creating a re-imagined *Gemeinschaft*, where residents are bound by their shared values.

### 2.2 Reduced domestic energy consumption in Ecovillages

In contrast to mainstream society, there is evidence that residents in Ecovillages have significantly reduced domestic energy consumption. By first thought, this might appear obvious, since Ecovillages are – after all – intentional communities with residents identifying themselves as being concerned about the environment. However, as studies have demonstrated, disagreement between people’s expressed values and actual actions is a widespread phenomenon, which has been termed the value-action gap (Blake 1999) (Kollmuss and Agyeman 2002). Shove criticizes the research behind this term for implying a causal relationship between values and behavior (Shove 2010). While sympathizing with this critique, we believe that the observation of discrepancies between people’s expressed values and actions is an important empirical finding, which makes it interesting to understand why domestic energy consumption is lower in Danish Ecovillages (the aim of this study). In answering this question, we will focus on how the built environment and social norms of Ecovillages result in everyday practices that reduce energy consumption.

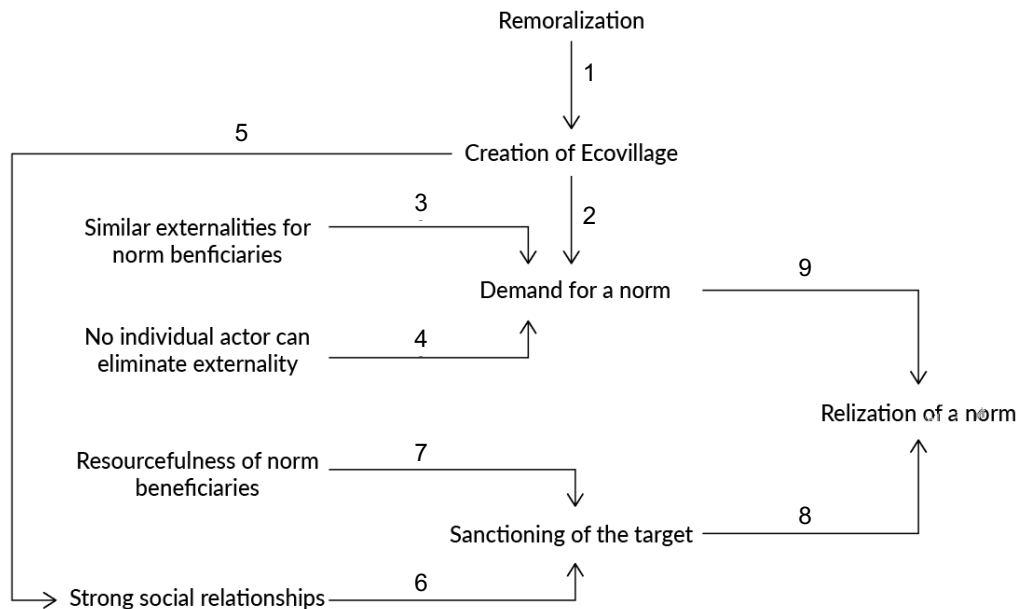
The *built environment* consists of the site layout, architectural design, building materials, mechanical and electrical systems of communities. While energy used by buildings and appliances are inherent by design, Ecovillages often decide on what major systems to use as a community and often choose more sustainable options (Marckmann, Gram-Hanssen and Christensen 2012). A *social norm* is defined as “an expectation about how one ought to act, enforced by the threat of sanctions or the promise of reward” (Kerr 1995). Sanctions are reactions that attempt to alter behavior to align with the norm beneficiary’s expectations. Norms regulate behavior and are based on a socially shared belief about how one ought to behave, and they are often nuanced and vary based on the social context. There are unlimited examples of social norms in everyday life, including whether or not to litter, scold a stranger’s child, vote, smoke in public, or stash tea bags from a communal office supply (Coleman 1990). James Coleman provides a theory of how norms emerge that could be useful in understanding the mechanism for lowered energy consumption in Ecovillages.

Coleman’s theory argues that new norms might emerge if three conditions are satisfied (Coleman 1990). The first condition is that a group of people experience similar externalities, or positive or negative consequences, from certain actions. The detrimental impacts of domestic energy use on the planet are extreme negative externalities for everyone. The second condition is that a system of exchange cannot solve the problem. Ecological Modernization is society’s attempt to solve the carbon emissions problem through the market, by commodifying carbon dioxide emissions. As discussed previously, this approach has not been effective. The third condition is that no individual actor can eliminate the externality. This is the case with carbon dioxide emissions, where it would be impossible for a single individual to solve the problem.

Even if the above three conditions exist, a norm will not necessarily be realized. In the case of domestic energy consumption, it would be very impractical and unrealistic for an individual to expect their neighbors to change their way of life to radically reduce energy consumption. Any individual who tries to enforce such a norm might expect serious pushback. This pushback is the cost of enforcing a norm. Danish Ecovillages, however, have found a way to minimize the cost of sanctions through strengthening social relationships between norm beneficiaries, which is described by Coleman as a necessary pathway towards the realization of a norm. While many people feel like their individual sacrifices and lifestyle changes in regards to domestic energy consumption will not make a difference, Coleman argues that strong social relationships ensure that the sacrifices for abiding to a norm will be shared by all of the sanctioning actors. This makes it more likely for norm beneficiaries to sanction targets of norms (Coleman 1990). Through sanctioning, the norm is then realized.

### 2.3 Pathway for norm realization in Danish Ecovillages

A diagram for the dynamics behind the realization of a norm for reducing domestic energy consumption in Danish Ecovillages is shown in Figure 1. This diagram was modeled from a previous reconstruction of Coleman’s Theory of Norm Emergence by Opp (Opp 2018). *Remoralization* is the catalyst for the formation of the Ecovillage (*relationship 1*). The demand for the norm is increased by the creation of the Ecovillage (*relationship 2*), similar externalities for norm beneficiaries (*relationship 3*), and the fact that no individual actor can eliminate externalities (*relationship 4*). The strengthening of social relationships (*relationship 5*) through the formation of an Ecovillage (*relationship 6*) and the resourcefulness of the norm beneficiaries (*relationship 7*) increases the likelihood of sanctioning. The demand for the norm of reduced energy consumption (*relationship 8*) and sanctioning of targets (*relationship 9*) results in the realization of a norm of reduced energy consuming practices.



**Figure 1.** Diagram for norm emergence of reduce domestic energy consumption in Danish Ecovillages. Arrows depict relationships (which are labelled 1-9) which increase likelihood of realizing the norm.

This framework has inspired the empirical analysis of this paper, in which we will focus on the dynamics behind norm formation of Ecovillages.

### 3.0 METHODS

### 3.1 Field work approach

An investigation of the built environment and pathway for norm emergence was conducted in a study of seven Ecovillages in Denmark. Self-identified Ecovillages in close proximity to Copenhagen were approached to participate in the study. Five of the Ecovillages were enrolled after google searching for Ecovillages with close proximity to Copenhagen and reaching out to a designated contact on the community's website. Two Ecovillages enrolled through personal contacts. The seven communities represent a variety of contextual locations, scales, and years of establishment (Table 1). Site visits were conducted from September through December 2017. Site visits ranged from three hours to multiple days and included a tour of the Ecovillage with at least one community member. Recorded, semi-structured interviews were conducted with at least one Ecovillage resident, usually including the designated contact person for outside visitors. The ecovillages were anonymized with letters A through F.

Interview questions were developed through a literature review and general understanding of the social and architectural everyday practices that consume energy. Ecovillage ways of life and baseline characteristics were also assessed. The theoretical work mentioned previously informed ways to organize the analytical data. Factors influencing the built environment and social norms were organized from listening to recorded interviews and reading site notes.

### 3.2 Energy data

Energy use data for ecovillages A, B, and F were collected and analyzed. In all three cases, the energy data had previously been collected by the Ecovillages for internal purposes and then given to the researchers. The annual net energy used for space heating, domestic hot water, and plug loads in residential units and the common house were collected. The total number of residents, area of residential units, number of residential units, and sources of energy were also recorded and assessed. A residential unit was defined as an independent residence. The energy data was retrospectively collected by the researchers, which presents a source of error. The researchers tried to mitigate this error through a detailed review of the energy data with the Ecovillage residents that originally collected and compiled the energy data to verify correct understanding of the metrics.

The energy data for the ecovillages was compared against a baseline of Danish homes. Heating load consumption and plug load were assessed separately, since heating load is largely dependent on building characteristics like heat transfer through building envelope, while plug load is associated with number of residents (Gram-Hanssen 2013). Baselines for space heating and hot water use were derived from a study from the Danish Building Research Institute (Witthen, Kragh and Aggerholm 2016), and Ecovillages were compared to a building of a similar typology (standalone, row-house) and year of construction. Data from the Danish Energy Agency's 2015 report for single family homes was used to compare plug load (Agency 2017).

The energy data results are not definitively conclusive, but are used in the study to understand overall energy use in the Ecovillages.

**Table 1.** Characteristics of Ecovillages

Ecovillage	Location	Type	Established	No. Residents	No. Units
A*	Rural	Retrofit	1984	11	6
B*	Rural	Standalone	1989	190	76
C	Rural	Retrofit	1978	159	60
D	Semi-Rural	Standalone	2014	60	20
E	Rural	Standalone	2005	73	20
F*	Semi-Rural	Joint	2000	225	100
G	Semi-Rural	Joint	2015	75	20

\*Energy Consumption Assessed. For Ecovillage B, energy data was assessed for a housing group built in 2007 (shown in Figure 3d), with 6 units and 14 residents.

## 4.0 FINDINGS

### 4.1 Built Environment

Ecovillages show great variety in their architectural expressions. Three different architectural typologies were observed and categorized by the authors of the current study: retrofit, standalone, and joint development. The variation of architectural typologies was largely due to circumstantial factors such as location, finances of founding group, regulations of local municipalities, and the history of the community.

#### 4.1.1 Retrofit Ecovillages

Retrofit ecovillages are renovated existing buildings that has been converted into ecovillages. Ecovillages A and C are of this type. These buildings are repurposed to reflect the community's common values and way of living. They are

renovated to provide independent units for families, and have shared spaces for communal cooking, dining, clothes washing and storage, etc. They are poorly insulated buildings, and the residents constantly need to work on the buildings for better insulation and general maintenance. Ecovillage A (Figure 2) is in an old farm building complex renovated in 1984 that was initially built in 1822. The residents have improved insulation through various interventions, including adding paper wool to the air gap between the brick wall cavity, adding layers of mineral wool insulation to the inside face of the walls, and adding insulation to roof. The floor is not insulated, however. Renovations and upkeep in retrofit ecovillages is a continuous task, which requires constant engagement from the community. In both communities, there are communally produced sources of energy, and individual units are not metered separately.



**Figure 2.** Ecovillage A is a rural, retrofit ecovillage. The community lives in an old farm complex, with energy sources from PV panels, solar water heaters, and a wind turbine (a). Units are connected by an internal hallway (b). Communal spaces include communal dining (c) and kitchen (d).

#### 4.1.2 Standalone Ecovillages

Standalone ecovillages are communities with experimental houses designed by a resident or an architect. The site plan expresses common values, but the owner decides how to design their own house in accordance with the mission of the community. Each owner owns their own parcel, but the community shares a common house and common amenities. Ecovillages B, D, and E are standalone communities. Ecovillage B is shown in Figure 3. The community was established in 1989, and construction on the last parcels is ongoing. There are seven housing groups, 60 houses already built, and 130 adults and 60 children presently living there. The site plan was intentionally designed so that individual parcels are oriented towards the south to provide auxiliary heating from sun (Figure 3a). The community owns a windmill that produces three times the amount of electricity than the community consumes. Most houses are heated individually by wood pellets, heat pumps, or solar water heaters (Figure 3bc). The housing group shown in Figure 3d was constructed in 2007 and is heated by a geothermal heat pump system, shared by all seven houses. These row houses have dividing brick walls, one built and paid for by each resident. The owners were able to fill the space between the walls with their own individual design. The facades are made of wood, with cellulose paper insulation, and high-performance windows.



**Figure 3.** Ecovillage B is a rural, standalone ecovillage. Individual parcels with homes are oriented to provide auxiliary heating from sun (a). Homes range in styles, but all incorporate passive solar strategies (b-d).

### 4.1.3 Joint Development Ecovillages

Joint Development ecovillages are cohesive communities built at once. An architect typically designs these communities, with input from the founding group. Ecovillage F is an example of a joint development ecovillage. It was established in 2000, with five housing groups of 20 homes. Each housing group has different ownership structure and resident types. The owners, seniors, young adults, families, and collectively owned groups are arranged in a circular cluster with their own common houses (Figure 4a). The private residences are wooden row-houses that exceeded building codes at the time they were built, with dividing walls made of non-burned compressed soil bricks. The walls have paper-based insulation, but over the years it was discovered that the basements are not insulated well. The buildings are heated by a central wood burning plant owned by the community (Figure 4), with auxiliary heating coming from solar water heaters. The community also jointly owns solar panels located on the roofs of the row-houses. The common house for the owner group is shown in Figure 4, and is made of straw bale construction. The common house has a shared kitchen, dining, laundry, freezers, and storage.



**Figure 4.** Ecovillage F is a semi-rural, joint development ecovillage. It was built all at once, and designed by an architect with input from the community. The site plan of the community creates circular grouping of houses and common houses (a). The community has a shared furnace for heat source (b). Rowhouses have solar water heaters and solar panels for electricity (c). The common house of the owner group is of straw bale construction (d).

## 4.2 Social norms

In an attempt to provide evidence for the pathway for norm emergence of reduced domestic energy consumption in Danish Ecovillages shown in Figure 1, a descriptive analysis of each relationship of the pathway was assessed.

### 4.2.1 Creation of Ecovillage

*Remoralization* played a large role in establishing ecovillage communities (*relationship 1*). Despite the various architectural forms and social norms observed in the ecovillages, when asked why they decided to live in an ecovillage, all interviewees responded that they wanted to live differently. There was a sense that mainstream housing was not fulfilling certain moral needs, and that by living together they could make a difference (*relationship 4*). In describing the mission of their communities, residents would repeat the same three general common values: collective living, self-reliance, and benefiting greater society. Some residents acknowledged all of these common values when asked to describe their communities. Ecovillage A summed up the mission of their community as follows:

We are three communities as we say, we have shared housing, we have shared production, and we have a shared interest in wanting to make a difference in the world.

In other ecovillages, residents would acknowledge one of these values but the other two would reveal themselves later in conversation. At Ecovillage G, a resident described self-reliance as a *remoralizing* value by saying the community “(...) started with an idea of being self-sufficient with energy”. As the interview progressed, however, the importance of participating in collective living was revealed as it was explained that a vegan family left the community because they

were unable to participate in the common dinners which were not vegan. When values do not align within a community, contradictions in expectations may leave some residents feeling unsatisfied. A resident of Ecovillage B explained how a weakened mission may deter communities from achieving higher levels of sustainability:

Of course, everyone is interested in ecology, but on different levels... Progress may not be as quick as in other places, because it depends on the people moving in and people have different expectations.

#### 4.2.2 Strong social relationships

We observed various ways that Ecovillages residents strengthen social bonds (*relationship 5*). Regular common meals are important community building practices that were present in all ecovillages. Ecovillage residents participated in at least one common meal per week, and two communities that were visited had common meals every weekday. Residents took turns purchasing ingredients and preparing meals for each other. All residents that were interviewed agreed that common meals were the most important social activity which brought residents together and allowed them to form strong friendships. Many community members believed that the common meals were also an important factor in reducing waste and energy consumption. Cooking in bulk minimizes waste, and cooking for many people at once increases the energy efficiency of the meal.

Ecovillages also strengthened social relationships through their volunteer and interest groups. Volunteer groups are groups that perform maintenance for the Ecovillage and participation was expected. Volunteer groups ranged from community outreach, landscape maintenance, and energy production management. In most Ecovillages, it was expected that the residents volunteer at least one hour per week for the community in one volunteer group. Interest groups also formed with people of similar interests. Groups ranged from people that would come together to play music, practice yoga and meditation, or walk together. Interest groups were regularly mentioned as very important in developing relationships in the Ecovillages.

#### 4.2.3 Demand for norm of reduced energy consumption

All Ecovillage residents that were interviewed expressed dissatisfaction with the detrimental effects of global warming. It was very apparent that they viewed carbon dioxide emissions and domestic energy use a cause of externalities (*relationship 3*). The demand for a norm of reduced energy consumption was greatly expressed in the design of their communities, as they made very intentional design decisions that reflected a demand for a reduction in energy use.

The major factors of community design that reflect a demand for a norm of reduced energy consumption were communal areas for hang-drying clothes and communal freezers. Individual houses rarely had clothes washer, dryers or freezers, but instead, these were provided in the common house. All communities produced their own energy through solar panels, wind turbines, or biomass boilers, and they also invested in very efficient delivery systems. The common energy production increased the demand for a norm, since communities typically had a goal to achieve net zero energy.

#### 4.2.4 Sanctioning of target

Communal sanctioning for high energy consumption was apparent in the Ecovillages. Since the Ecovillages had shared energy production, they regularly met about energy use and distributed energy consumption data for each household with the whole community. This would lead to sanctioning in various forms (*relationship 6*). Some community members said they would hold friendly competitions with each other to see who would use the least energy. One community noticed a trend that the families with the most teenagers used the most amount of electricity. They would constantly remind the teenagers to refrain from using too much. Another community even had one person who was in charge of sanctioning for high energy use (*relationship 7*). The "sanctioner" would be required to help community members who were having a hard time reducing their consumption. This created conflicts in the community, with a family ultimately leaving the community who was tired of the sanctioning.

#### 4.2.5 Realization of a norm of reduced energy consumption

All Ecovillage communities made a conscious effort to reduce energy consumption. One resident stated the importance of this communal effort:

I believe just being conscious about energy use, and discussing it as a community, makes the most difference.

As mentioned before, communities share facilities for laundry and have areas for hang drying clothes. Many communities also share freezers and have common storage areas. Apart from sharing resources that consume energy, residents also monitor energy use and make a conscious effort to reduce their own electricity consumption. Residents make lifestyle choices to reduce energy use such as turning off standby devices, turning off lights, and taking short showers. This shift in lifestyle indicates that a norm has emerged, because residents are doing what they think is right (*relationship 9*) and expect other community members to do the same (*relationship 8*).



### 4.3 Everyday practices and energy data

Energy data was collected for Ecovillages A, B, and F, which represents retrofit, standalone, and joint development ecovillages respectively.

#### 4.3.1 Reduction in Heating

All three ecovillages showed a reduction in energy consumption from baseline values. These reductions may be associated with everyday practices shared among all ecovillages of improving insulation and savings on heating laundry and storage rooms by bundling these spaces in the common houses. Reductions in heating was less in Ecovillage A, at 30% reduction, as opposed to Ecovillage B and F, at 44% and 42% reduction respectively. This may be due to the fact that it is difficult to insulate retrofit ecovillages like Ecovillage A. Ecovillage B was designed with passive solar strategies, with south facing windows, good insulation, and thermal mass, which has the potential to provide significant energy savings to heating (Lechner 2014). This may account for why Ecovillage B showed the highest reduction in heating.

#### 4.3.2 Reduction in Plug Load

All three ecovillages also showed significant reductions in plug load consumption, with all ecovillage showing a reduction of over 50% (

Figure 5). Reduction in electricity could be attributed to a conscious effort to reduce electricity consumption by the residents. In Ecovillages A and F there are shared freezers that most of the residents use. In all of the ecovillages, there are shared laundry facilities, and most residents hang dry their clothes. The regularity of communal dinners in Ecovillages A and F may also play a large role in reducing electricity consumption. The south facing windows in Ecovillage B may also contribute to less lighting load demand.

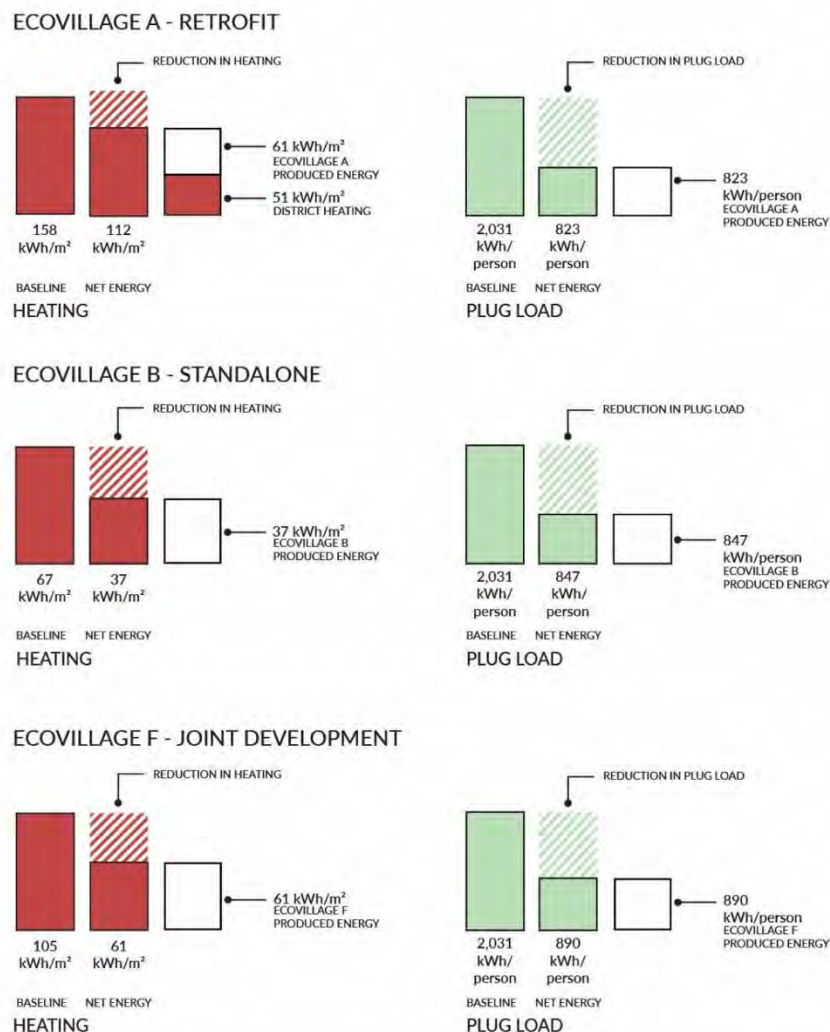
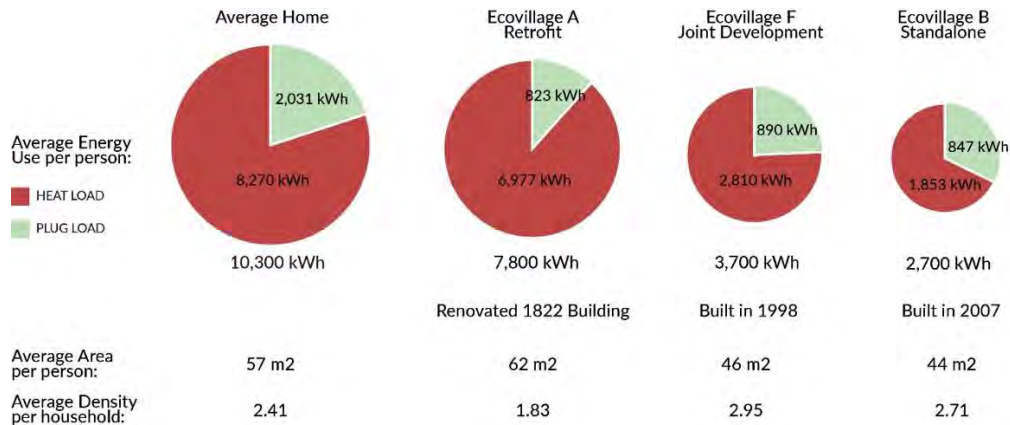


Figure 5. Energy Consumption for Ecovillage A, B, and F.

### 4.3.3 Domestic energy per person

Domestic energy consumption per person in Denmark compared with the Ecovillages is shown in Figure 6. All three ecovillages showed a reduction in energy use compared with the Danish national average. Year of construction was shown to play a large role in energy consumption for heating in the ecovillage. The heat load per person for the retrofit ecovillage was 89% of the total energy consumption, and is shown to decrease as year of construction increases. This suggests that as building envelope increases in efficiency, plug load starts to play a much more significant role in energy consumption.



**Figure 6.** Domestic energy consumption per person in Denmark compared with energy consumption per person in Ecovillages A, B, and F.

## 4.0 DISCUSSION

The findings of the current study suggest that the architecture and social norms of Ecovillages are associated with everyday practices that reduce energy use. Energy used for heating was strongly associated with year of construction in the three Ecovillages observed, suggesting that technological and regulatory changes in building envelope construction heavily impacts heating loads, just as in mainstream housing. When compared with homes built at similar times, however, Ecovillages show a significant reduction in heating consumption. This could be attributed to a variety of everyday practices ranging from improvements in insulation, different expectations for thermal comfort from mechanical systems, and sharing underutilized spaces such as laundry and storage rooms.

Observed reduction in electricity consumption in the ecovillages is substantial, over 1,000 kWh per person in each Ecovillage studied. This reduction is not surprising if considering the reduction in appliance use related to the everyday practices. According to the Danish Energy Agency, dryers and freezers consume 421 kWh/year and 288 kWh/year respectively in typical Danish households (Agency 2017). Monitoring personal energy use has also been observed to lower electricity consumption (Gram-Hanssen 2013). Communal production of energy gives Ecovillage residents a sense of autonomy over energy production, and many Ecovillages track their consumption practices to ensure they achieve net-zero energy. Unlike conventional housing, Ecovillage residents had the opportunity to discuss and set goals about each other's energy use because of their communal energy production, which led to pressure to change everyday practices that use energy. Energy saving everyday practices that were observed include: using energy efficient appliances, sharing appliances, sharing freezers, hang drying clothes, turning off standby appliances, cooking communal dinners, and remembering to turn off lights.

This study demonstrates how norms emerge in Danish Ecovillages that promote everyday practices that reduce domestic energy consumption. A diagram of norm emergence was proposed in Figure 1, and evidence for different relationships of the diagram is outlined in the findings.

## 5.0 CONCLUSION

Ecovillages are intentional communities that unite residents over common values and strengthen their social bonds. While mainstream society has achieved marginal reductions in domestic energy consumption, the Danish Ecovillages in this study showed substantial reductions in energy use. They seem to have done this by adopting everyday practices that are radically different than in mainstream housing. These energy saving everyday practices can be attributed to a combination of the design of the built environment and the social norms that emerge in these communities.

## 6.0 REFERENCES

- Agency, Danish Energy. 2017. *Data, tables, statistics and maps. Energy Statistics 2015*. Copenhagen: Danish Energy Agency.
- Blake, James. 1999. "Overcoming the 'value-action gap' in environmental policy: Tensions between national policy and local experience." *Local Environment* 4 (3): 257-278.
- Boyer, Robert. 2018. "Intermediacy and the diffusion of grassroots innovations: The case of cohousing in the United States." *Environmental Innovation and Societal Transitions* 26: 32-43.
- Boyer, Robert. 2014. "Sociotechnical Transitions and Urban Planning: A Case Study of Eco-Cohousing in Tompkins County, New York." *Journal of Planning Education and Research* 34 (4): 451-463.
- Christensen, Toke, Mirjam Godskesen, Kirsten Gram-Hanssen, Maj-Britt Quitzau, and Inge Røpke. 2007. "Greening the Danes? Experience with consumption and environment policies." *Journal of consumer policy (Journal of Consumer Policy)* 30 (2): 91-116.
- Coleman, James. 1990. *The Emergence of Norms*. New York: Aldine de Gruyter.
- Cook, John. 2016. "Consensus on consensus: a synthesis of consensus estimates on human-caused global warming." *Environmental Research Letters* 11 (4): 048002.
- Danish Energy Agency. 2020. "2019. Data, tabeller, statistikker og kort." Copenhagen.
- Ewing, Jeffrey. 2017. "Hollow Ecology: Ecological Modernization Theory and the Death of Nature." *Journal of World-Systems Research* 23 (1): 126-155.
- Giddens, Anthony. 1990. *The consequences of modernity*. Stanford, Calif: Stanford University Press.
- Gram-Hanssen, Kirsten. 2013. "Efficient technologies or user behaviour, which is the more important when reducing households' energy consumption?" *Energy Efficiency* 6 (3): 447-457.
- Gram-Hanssen, Kirsten, Toke Haunstrup Christensen, and Poul Erick Petersen. 2012. "Air-to-air heat pumps in real-life use: Are potential savings achieved or are they transformed into increased comfort?" *Energy and Buildings (Energy and Buildings)* 53: 64-73.
- IEA. 2019. *World Energy Outlook 2019*. IEA. Accessed September 8, 2020. [www.iea.org/reports/world-energy-outlook-2019](http://www.iea.org/reports/world-energy-outlook-2019).
- Jackson, RB, Quéré CL, Andrew RM, Canadell JG, Korsbakken J I, Liu Z, Peter GP, and Zheng B. 2018. "Global energy growth is outpacing decarbonization." *Environmental Research Letters* 13 (12): 120401.
- Jensen, Jesper Ole, and Kirsten Gram-Hanssen. 2008. "Ecological modernization of sustainable buildings: a Danish perspective." *Building Research & Information* 36 (2): 146-158.
- Jensen, Ole Michael. 1994. "Økologisk Byggeri - eller blot miljørigtig projektering." *Arkitektur DK* 7: 353-367.
- Kerr, Norbert L. 1995. *Norms in Social Dilemmas*. Westport, Conn: Praeger.
- Kollmuss, A, and J Agyeman. 2002. "Mind the Gap: Why do people act environmentally and what are the barriers to pro-environmental behavior?" *Environmental Education Research* 8 (3): 239-260.
- Lechner, Norbert. 2014. *Heating, Cooling, Lighting*. John Wiley & Sons, Incorporated.
- Marckmann, Bella, Kirsten Gram-Hanssen, and Toke Christensen. 2012. "Sustainable Living and Co-Housing: Evidence from a Case Study of Eco-Villages." *Built Environment* 38 (3): 413-429.
- McNutt, Marcia. 2013. "Climate Change Impacts." *Science* 341 (6145): 435.
- Murphy, Joseph. 2000. "Ecological Modernisation." *Geoforum* 31 (1): 1-8.
- Nagelkerken, Ivan, and Sean Connel. 2015. "Global alteration of ocean ecosystem functioning due to increasing human CO<sub>2</sub> emissions." *Proceedings of the National Academy of Sciences* 112 (43): 13272-13277.
- Opp, Karl-Dieter. 2018. "Externalities, Social Networks, and the Emergence of Norms: A Critical Analysis and Extension of James Coleman's Theory." *Social Research* 85 (1): 167-196.
- Princen, Thomas. 2003. "Principles for Sustainability: From Cooperation and Efficiency to Sufficiency." *Global Environmental Politics* 3 (1): 33-50.
- Saha, Devashree, and Robert G Paterson. 2008. "Local Government Efforts to Promote the 'Three Es' of Sustainable Development: Survey in Medium to Large Cities in the United States." *Journal of Planning Education and Research* 28 (1): 21-37.
- Sanguinetti, Angela. 2014. "Transformational practices in cohousing: Enhancing residents' connection to community and nature." *Journal of Environmental Psychology* 40: 86-96.
- Shove, Elizabeth. 2010. "Beyond the ABC: climate policy and theories of social change." *Environment and Planning* 42: 1273-1285.
- Sorrell, Steve, Dimitropoulos John, and Matt Sommerville. 2009. "Empirical estimates of the direct rebound effect: A review." *Energy Policy* 37: 1356-1371.
- Tang, Zhenghong, Samuel D Brody, Courtney Quinn, Liang Chang, and Ting Wei. 2010. "Moving from Agenda to Action: Evaluating Local Climate Change Action Plans." *Journal of Environmental Planning and Management* 53 (1): 41-62.
- Urban, Mark. 2015. "Accelerating extinction risk from climate change." *Science* 348 (6234): 571-573.
- Wittchen, Kim, Jesper Kragh, and Søren Aggerholm. 2016. *Potential heat savings during ongoing renovations of buildings until 2050*. Danish Building Research Institute, Aalborg University.

# The Checkerboard Charleston House: A Model for Passive Urban Infill Housing

Craig S. Griffen<sup>1</sup>

<sup>1</sup>Thomas Jefferson University, Philadelphia, PA

**ABSTRACT:** Large sections of some US cities still contain an abundance of vacant land leftover from the flight to the suburbs. This land is slowly being developed with high-end market rate housing or with government-subsidized pastiche suburban-style homes; neither of which are ideal solutions to our current housing issues. As we rebuild the city, should we reconsider how to borrow the best qualities from both suburban and urban typologies to create hybrid passive houses that are brighter, energy-efficient and provide more open space? The Checkerboard Charleston House (CCH) is the latest version of a research /design project that studies how urban homes can be designed to provide more sunlight for heating and daylighting, natural ventilation and shading, healthy green space and a highly insulated envelope. Starting with the proven urban row house pattern, the CCH mirrors alternating houses forming a checkerboard pattern. This new home form, similar to the classic Charleston House form, gains a large south-facing side yard with access to sunlight, fresh air and additional green space for most rooms, providing a new hybrid typology that incorporates best practices from urban and suburban housing.

**KEYWORDS:** Passive, Urban, Suburban, Housing

## INTRODUCTION

In the last few decades, many US cities have seen a growth in their urban population with people moving back in. This sector is mainly concentrated in the urban core because of its many cultural amenities, ease of transportation and relatively safer neighborhoods. The abandoned urban land left over outside the urban core has not experienced the same degree of redevelopment with much land remaining vacant in many places. But this empty land in the outer city ring, close to the city core, still retains significant urban value. An existing infrastructure of utilities lines, streets and sidewalks, public transportation, commercial and institutional services are already in place, and do not need to be constructed from scratch, as is required in suburban development. Urban dwelling, because of its density of buildings, is well known as a sustainable mode for living because of the ability to share services. Shared apartment walls conserve energy, shared public transportation and walkable communities reduce car use and pollution, and so on. Therefore, this surviving network of infrastructure in neighborhoods with cheaper land costs provides a prime opportunity for a sustainable and healthy redevelopment of housing in the city.

While we have been fortunate to have experienced regrowth in cities for many years, there is worrying evidence that since approximately 2014 US cities growth rates have been declining. “The combination of city growth declines and higher suburban growth suggests that the “back to the city” trend seen at the beginning of the decade has reversed.”<sup>1</sup> Data released by the U.S. Census Bureau show that some 27,000 millennials between the ages of 25 and 39 left big cities in 2018 for the suburbs to combat the ever-increasing housing costs and lack of access to family-friendly amenities.<sup>2</sup> The rising costs of housing has made living in city centers financially unmanageable, not just for lower-income residents, but increasingly for the middle class as well. Of the 15 most expensive places to live in the US, most are urban metropolitan areas and all are located on the east and west coasts.<sup>3</sup> In these cities, lower wage workers are being forced to move farther and farther away from the city to find affordable housing, which only drives up transportation costs and pollution. But economics is not the only reason people are leaving the city. Many are looking for family-friendly amenities found in the suburbs. Quality public schools, larger homes, more green space, convenient shopping and easy parking also account for the outward migration.

The current pandemic and issues of climate change could speed up this rate of exodus. The NY Times recently reported that “the pandemic has convinced some New Yorkers that it’s time to finally give up on city living...that in today’s era of social distancing, one-person-at-a-time elevator rides to get home and looping routes to avoid passers-by on city streets has fundamentally changed New York City”.<sup>4</sup> Many city dwellers who found themselves and their families trapped inside their homes for weeks on end, learned how confining apartment living could be. People who could afford vacation homes or had family outside the city, left to escape the pandemic. While many will return when safe, others are now considering never coming back. Even when there is a vaccine, some real estate agents do not think there will be an immediate return, comparing it to 9/11 when there was a 3-year outward migration before it

reversed.<sup>5</sup> People have discovered working from home can be extremely feasible so are considering if the risks of returning to dense urban environments are worth the gamble. The pandemic is causing people to question how and where they want to live. This moment could be an opportunity to reconsider how we can rebuild our cities in smarter, healthier, and more sustainable ways to attract/retain these people in the city. But what kind of urban housing will make buyers feel safe enough to forego the comforts of a suburban lifestyle? When it becomes safe to return to the city, convincing people to return may require offering alternate or hybrid forms of housing that bring certain suburban amenities to the urban context.

### **1.0 SMART REBUILDING**

The typical row houses surrounding the former factories of our 19th century cities were built to be cheap, basic, no-frills housing for blue-collar workers. Sixteen-foot-wide houses built right on the street with low ceilings, small windows on only narrow front and back facades and tiny back “yards”, created dark, cramped spaces with little access to air, light and space. So, offering modern versions of the row house may not attract suburban buyers back into the city. Small yards offer little exterior escape relief and negligible green space. In addition, most factory workers relied on public trolleys and had no car, so space for parking was never considered in the original planning and is a significant problem today in older neighborhoods with on-street-only parking. Prospective urban home buyers may need to be enticed with certain desirable qualities of suburban living.<sup>6</sup> To draw them, some builders are already offering suburban amenities like rooftop lawns with hammocks, easy parking and house-like apartments in their new urban developments claiming “the suburban life in the city is what we’re going for.”<sup>7</sup>

Unfortunately, recent redevelopment of vacant blocks in many cities (often sponsored by governmental housing authorities) reveals a trend for constructing suburban-style single-family detached homes that are greatly out of context in the urban environment. Pseudo-colonial homes with 2-car garages, large backyards and even the occasional picket fence are the antithesis of the former worker row homes they replaced. Directly transplanting suburban housing models into the city may bring in desirable suburban qualities, but it also destroys the urban contextual patterns and culture that give the city its identity, and therefore is not an appropriate strategy. Still, annual surveys by the National Association of Realtors constantly reveal that 70% of home buyers prefer detached, or single-family, housing.<sup>8</sup> Drawing people back to the city by offering both attached and detached housing options seems to be financially prudent. It also presents an opportunity to look at a hybrid housing model that incorporates only the most preferred suburban amenities while still preserving the best qualities of urban living.

### **2.0 CHECKERBOARD CHARLESTON HOUSING**

The common tightly-packed attached workers row house found in many US cities has very limited access to sunlight, fresh air and open space. The narrow front and back facades are the only elevations with windows for access to light and air and the “postage stamp” sized backyard is only accessible to one room at the rear. However, if we start with that proven urban row house pattern, but slide and flip alternating houses back to face a new interior lane, it creates a checkerboard pattern. Now, instead of a small back yard, each home gains a larger south facing side yard with access to light, air and green space for most rooms. (Fig. 1) Where the alternating checkerboard pattern hits the gridiron of east-west cross streets it gains extra green space at the north and loses green space at the south. Rather than viewed as leftover space, there is an opportunity to develop this land in ways that enrich the diversity of the neighborhood. At the north end of the checkerboard block, the additional public green space could become neighborhood pocket parks and playgrounds where the community can gather. Conversely, the south end of the checkerboard block lacks green space and therefore would not provide a yard for single-family homes. Here the buildings front directly on the sidewalk so are well suited for commercial and institutional needs such as the traditional “corner store” or as vital daycare centers that are in high demand. Above these public spaces, smaller apartments would attract renters who are not in the market for a large detached home but need affordable housing. All these functions at both block edges would add important social/economic diversity to the neighborhood, serve as public buffer zones to the residential houses, and avoid exclusively detached residential use.

Previous research investigating the potential for passive energy strategies in suburban developer housing revealed that the Charleston house typology, with a gallery opening onto a side yard for access to cooling breezes, worked well as a precedent to provide both passive heating and cooling. This typology has a long-established record in the urban setting of Charleston, and Renee Chow has demonstrated how this pattern can be a sustainable solution for increasing density in a suburban setting.<sup>9</sup> It was not surprising to find it also works well in a hybrid situation to provide access to light, air, shade through a private green courtyard space. Details of the healthy and sustainable advantages of the Checkerboard Charleston (CC) pattern over a typical row house are listed below.



Figure 1: CCH Site Plan Diagram. Source: (Author 2020)



Figure 2: CCH Floor Plan. Source: (Author 2020)

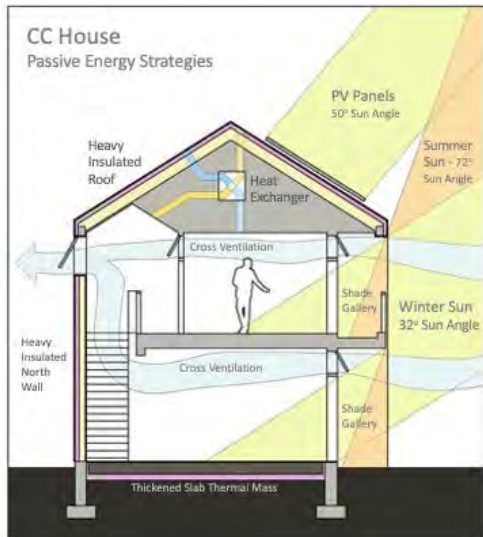
**Green Space** – The typical row house with its narrow back façade, has at most 2 rooms facing the diminutive backyard. By shifting every other CC House back and creating side yards, all major rooms along the long south side of the house open directly onto a sun-lit, landscaped yard which can serve as a much-needed outdoor green space. The private open yard also provides wildlife habitats, absorbs carbon dioxide, releases oxygen, reduces heat island effect and absorbs storm water runoff. (Fig. 2)

**Off-street Parking** – While urban dwellers should be encouraged to utilize public transportation as much as feasible, grocery stores in developing neighborhoods are rare and often too far to walk. Street parking in dense neighborhoods is often scarce, and the lack of it is a major deterrent when trying to encourage residents to stay in the city. Also, many city building codes require one off-street parking space per living unit. For these reasons, each CC House has a dedicated off-street parking space that provides room on the street for guest parking, and being located next to the home, allows for the installation of an electric vehicle charging station not practical with on-street parking. By using electric vehicles charged with clean energy generated by their own rooftop PV system (see below), you remove a major sustainable energy deterrent to urban car ownership.

**Modular Construction** – Housing costs are a major reason given for moving to the suburbs, so any new urban construction needs to be affordably priced. The developer housing industry has long learned that repetition and prefabrication are the main way to keep costs down so the CC House is designed to take advantage of modular prefabricated construction. The bulk of the long, thin home consists on (2) –14' x 50' (max.) modules that fit on the back of a flatbed truck, while bath and utility modules that form the buffer space can be attached to the side. The simple, repeating geometry of the gable roof shape means trusses can be prefabricated in the factory and quickly erected on the site, in the same efficient method suburban development houses are constructed today.

**Energy Efficient Envelope**– To maximize passive heating and cooling efficiency, the CC House should adopt the construction standards of the Passive House Institute US (PHIUS) to the greatest extent that is financially feasible. To create a well-insulated, air-tight envelope, the north, east and west facades have minimal windows to reduce the area of poorly insulating glass and the walls are heavily insulated, thermally-broken and sealed against air leaks. Service functions such as bathrooms, circulation, storage and utilities that require less light and heat create a thermal buffer space along the north wall. Having only few above eye-level windows on these facades also increases privacy from the neighbor's yard. Preliminary calculations using the *PHIUS Initial Cost Saving Premium and Source Energy Saving Estimator* predict a Passive House of this size in Detroit would cost \$14 more per square foot to build but would produce source energy savings of 57% per year compared to a 2009 benchmark. Savings from modular and panelized prefabricated construction would help offset the extra cost of the heavier insulated envelope and ventilation systems.





**Figure 3:** CCH Section. Source: (Author 2020)



**Figure 4:** CCH Perspective. Source: (Rendering by Marzea Akter)

**Sun-Tempered Home** – Passive House envelopes are more thermally efficient, and rely less on solar gain, than a traditional passive-solar-heated house. Sunlight in a Passive House only needs to be “managed to exploit the sun’s energy for heating purposes in the heating season and to minimize overheating during the cooling season”<sup>10</sup>. Therefore, the CC House can be an easier to achieve Sun-Tempered home; “this means orienting the long wall to true south (so the home is on an east-west axis) and moderately increasing the window surface area along the south side. This is usually achieved by moving windows which would normally be placed on the other sides of the house, so no extra construction cost is incurred on new builds.”<sup>11</sup> As a percentage of the home’s conditioned floor area, the sun-tempered home requires only 7% glass area as compared to 9%-12% for passive solar.<sup>12</sup> The CC House south facing glass area is variable and can range between 7% and 10% depending on climate, latitude, amount of sun degree days and orientation. The side yard of the CC House is strategically set back far enough away from the adjacent house so winter sunlight clears the neighbor’s roofline and can penetrate deep into the house. Because the long south facade is exposed to the entire side yard, all living spaces now have direct access to sunlight and daylighting which also have proven psychological and physical health benefits. By placing storage and utility functions in the buffer zone and attic, a basement is not required which saves construction costs and allows for an insulated-below, thickened concrete slab-on-grade to serve as a thermal mass. (Fig. 3)

**Solar Shading** – As in the Charleston House typology, the CC House uses a variant of an architectural exterior gallery along the south side of the home to shade the south windows and minimize overheating. The width of this space is dimensioned at 4 feet to shade the glazed south façade from the high-angled summer sun and reduce the air conditioning load. The gallery provides covered balcony and patio seating space protected from rain and also serves as a private service entry. (Fig. 4)

**Passive Cooling** – Before the advent of mechanical air conditioning, buildings were designed in thin blocks to encourage wind movement through the spaces. Row homes only have windows on the front and back which are spaced far apart, making natural ventilation difficult. The long, thin CC House with open sides is an ideal shape for creating cross ventilation which thereby reduces the need for air conditioning. A row of awning windows above the stair will draw rising hot air up and out of the house while simultaneously providing daylighting to the circulation spaces.

**Photovoltaic Power**– The simple form of the gable roof, with one long, south slope oriented in an optimal angle towards the equinox sun, can accommodate a large Photovoltaic array that can maximize PV power production throughout the year. The 400 square feet of panel space provides enough power from medium efficiency panels to supply the recommended 7 kW system for this size house. Using battery storage like the Tesla Powerwall system, electricity production can happen year-round and on a sunny day a block of CC houses could be a significant producer of PV electrical energy instead of a drain. This clean energy can also be used to charge an electric vehicle rather than pulling it from fossil-fuel-generated electricity from the grid.

### 3.0 SITING THE CC HOUSE

Not every urban site is a feasible location for the CC House. To work well, the pattern requires 1) enough affordable vacant land to repeat the checkerboard geometry, 2) the majority of streets/blocks should be oriented in a general north-south direction to maximize sunlight, and 3) street/block widths need to be within a range of dimensions that fits the pattern.

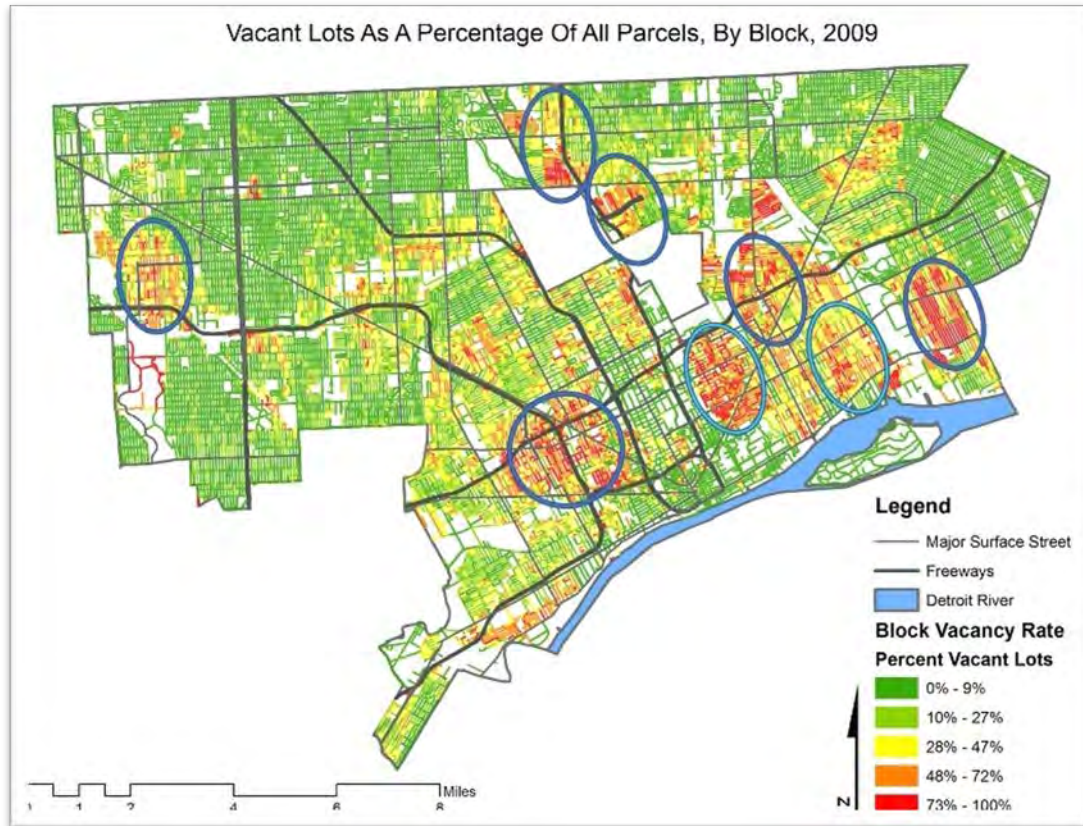
A myth of city living is that housing sales and rent prices are always more expensive than in the suburbs. But in certain markets it is the opposite. My home city of Philadelphia is one example. It is nearly twice as expensive to live in the Philadelphia suburbs as the average rent takes up 18.7% of the area's median income versus 9.8% in the urban market and mortgage payments take up an average of 30.5% of the median income compared to 20.9% in the city.<sup>13</sup> But these numbers are averages for the entire city and do not reflect the cost of housing in the high-priced urban core. To make this method affordable, the prime sites for this type of project are typically found in the gap of land between the urban core and first-ring suburbs. Land prices are lower in these areas because they are typically "less-desirable" neighborhoods, so redevelopment may need to be incremental and grow out from more established neighborhoods. However, these areas provide the necessary amount of affordable open land to make it financially feasible to develop blocks of housing with a slightly lower density to create the necessary open green space.

While a sun-tempered Passive House is not as dependent on solar orientation as a passive solar home, the long side of the CC House should face in a general southern direction. Therefore, cities that make good candidates for the CC House should contain street grids with long north-south oriented blocks. US cities, especially those outside the east coast, are relatively young (compared to Europe) with plenty of land, so were often laid out with a grid oriented to the cardinal points beyond their initial settled boundaries of the urban core.<sup>14</sup> Even though a strict north-south grid is preferable, it is not essential as sun-tempered houses oriented up to 20 degrees off both directions of due south still produce effective solar gain.

Because block sizes and building density requirements vary within and between cities, two model CC home sizes were created to test for flexible siting between locations. The smaller 2 to 3-bedroom home totals 1700 square feet (sf) and sits on a 2500 sf lot while the larger 3 to 4-bedroom house comes in at 2000 sf on a 3600 sf lot. The CC House is wider than the typical 20-foot row house, and to allow in winter sun, the side yard is larger than a typical row house back yard. This means the CC House lot size is approximately 20-25% larger than the standard cramped row home lot, but about 40% smaller than the suburban-style homes currently being constructed in cities. So, while not as dense as row homes, the CC House pattern is able to preserve the urban street wall to maintain the original contextual patterns, while also providing the open green space desired by today's home buyers. The dimensions of the CC House lot in its shorter N-S direction does not allow much room for adjustment because of the space needed for the winter sun to clear the house roof to the south and shine on the entire southern façade. The larger CC House lot width is 60' while the smaller CC House has a thinner lot width of 50' to increase the density of dwelling units per acre. There is more flexibility in the house's long E-W dimension because the setback distance from the sidewalk can be more easily adjusted to accommodate varying block sizes. Figure 1 shows how 4 rows of homes fit on a typical block size with 250' between property lines (measured to inside of sidewalk). On thinner blocks, the smaller 3-bedroom model with reduced street setbacks can easily be adjusted to fit.

### 3.1 TEST SITE - DETROIT

When considering the three qualities of potential sites for the CC House; cheap vacant land, N-S orientation and block width, the city of Detroit stood out as an excellent candidate in all three categories. First, the city has been well-documented as one that has suffered huge losses of housing stock since the mid-twentieth century and has not recovered. A map of vacant land in Detroit reveals an abundance of open land (16.75%,) in many neighborhoods as indicated by orange and red in locations where it is 70% or more vacant. (Fig. 5) Yet much of this land is close to the city center with access to existing public infrastructure, services and transportation. These neighborhoods present excellent potential for pursuing affordable redevelopment. Second, Detroit has 2 grid orientations, a newer one with a perfectly N-S orientation and the original settlement grid oriented towards the riverfront. The older grid, oriented in a NNW-SSE direction is slightly over the 20 degree maximum preferred for solar gain, but it is over in the right direction for a sun-tempered home. With the houses oriented towards the southeast, more eastern morning sun can warm the night-cooled home earlier in the day and prevent overheating from the hot, afternoon western sun. Third, Detroit is a mid-western city where new land was abundant when the city grid was established and expanded. Therefore, block sizes are larger than in most east coast cities built earlier. The typical block widths vary slightly between neighborhoods but average 250 feet (76 m). Most blocks include an interior alley that can be readily converted into a lane. In addition, the lot widths on the street average closer to 30' than the 20' typical of eastern cities. These proportions allow 4 rows of housing per block that can be adjusted with different house sizes and setback options to create favorable conditions for the CC House pattern.



**Figure 5:** Edited Map of Vacant Land in Detroit. Source: (Courtesy of Mapping the Strait Blog, Robert Linn)

Detroit is a prime candidate because there are multiple sections of the city that contain these three qualities with the most concentrated areas indicated by the blue ovals on the map. I selected two of these areas in the East Village and Poletown neighborhoods (light blue ovals) to study how the CC pattern fits at two scales. Because of the generous 30'+ lot widths, houses in these and most Detroit neighborhoods were not built as attached row houses, but as detached single and duplex homes with narrow side yards. Even though the CC House pattern has less density than a row house, it actually has a higher density than both of the existing neighborhoods studied. The Small CC House fits well in the block proportions of the Poletown neighborhood and produces a density of 17 dwelling units per acre (du/a) over the existing ratio of 14.5. The Large CC House fits well within the dimensions of the blocks in the East Village neighborhood creating a density of 12 du/a over the existing 10.4. The housing unit density recommended to financially support commercial services and public transportation needs in a community is 16 du/a and above.<sup>15</sup> While the smaller CC House exceeds this number and the larger house is below, both are above the averages for their neighborhoods and therefore preserve a strong urban density. In contrast, new suburban-style homes in the Marina District have a concentration of only 6.7 du/a which is well below the original and does not support a healthy urban density. (Table 1)

House Type	Detroit Location	Lot Size (avg)	Width (avg)	Lot Depth	DU/ Acre
Existing	Poletown	3000 sf	30'	100'	14.5
CCH - Small	Poletown	2500 sf	50'	50'	17
Existing	East Village	4200 sf	35'	120'	10.4
CCH - Large	East Village	3600 sf	60'	60'	12
New "Suburban"	Marina Dist.	6500 sf	60'	110'	6.7

**Table 1:** Density Comparison Chart. Source: (Author 2020)

## CONCLUSION AND NEXT STEPS

The repopulation of the cities by young, affluent professionals that started around the turn of the millennium, was a great boost for our cities after decades of “white flight”.<sup>16</sup> But with that trend starting to reverse itself due to increasing housing costs, pandemics and climate change, now is a good time to reconsider how we are rebuilding our cities. The CC House pattern presents just one approach to encourage residents to remain in the city, or return when they feel it is safe. By offering the hybrid, best-of-both-worlds qualities of the additional light, air and space of the suburbs, along with the urban amenities of a walkable city location, it could appeal to a range of home buyers. It is important to consider that even though a single-family detached house is attractive to a large population, there is a significant demographic of people who have different needs. The typical home buyer family with 2.5 children is a decreasing percentage of the market while there is a projected increased need for homes for those without children such as empty-nesters and single adults.<sup>17</sup> Smaller, lower-maintenance, attached housing for sale or rent is increasingly in demand which presents a challenge of investigating how the principles behind the CC House can be adapted to these housing types. It should also be noted that while all of the energy-saving strategies above closely follow proscribed passive design guidelines, a more extensive passive energy analysis is required. So, research funding is currently being pursued to calculate energy performance in greater detail so we can more effectively evaluate the full potential of this hybrid form of urban housing.

## REFERENCES

1. William H. Frey, *Big city growth stalls further, as the suburbs make a comeback*, Brookings Institute, May 24, 2019
2. Janet Adamy and Paul Overberg, *Millennials Continue to Leave Big Cities*, Wall Street Journal, Sept. 26, 2019
3. Andy Kiersz, *The 15 most expensive cities in America*, Business Insider, May 17, 2019
4. C. J. Hughes, *Coronavirus Escape: To the Suburbs*, New York Times, May 8, 2020
5. Lisa Prevost, *The Suburbs Pull; Real Estate’s Pandemic Shift*, New York Times, July 19, 2020
6. Gabriel Popkin, *Can expensive, ultra-green homes sell in a gritty suburban Maryland town?*, Washington Post Magazine, May 18, 2017
7. Candace Jackson, *The Suburbs Are Coming to a City Near You*, New York Times, May 18, 2019
8. Daniel Parolek, *Missing Middle Housing*, Island Press, Washington, 2020
9. Renee y. Chow, *Suburban Space: The Fabric of Dwelling*, (University of California Press, 2002
10. PHIUS Passive House Institute United States, <https://www.phius.org/home-page>
11. *What is a Sun-Tempered Home?*, <http://www.solar365.com/green-homes/what-sun-tempered-home>,
12. Cost-Effective Passive Solar Design, Green Building Advisor, <https://www.greenbuildingadvisor.com/article/cost-effective-passive-solar-design>
13. Heather Senison, *The Suburban Burden: Living In The City Is Less Expensive In These Areas*, Forbes Magazine, October 17, 2018
14. Geoff Boeing *Urban spatial order: street network orientation, configuration, and entropy*, Applied Network Science, August 23, 2019
15. Parolek
16. Richard Florida, *The Urban Revival Is Over*, New York Times, Sept. 1, 2017
17. Parolek





# Intricate Compatibility: Study of a Hillside Lot in Tokyo

Chris Jarrett<sup>1</sup>

<sup>1</sup>University of North Carolina at Charlotte, Charlotte, NC

**ABSTRACT:** The study of the Overlap House by Akihisa Hirata, and the theoretical context within which it is situated, is part of a body of ongoing design research that investigates environmental architectures and eco-spatial system thinking. Despite the increased focus on sustainable design globally, and the certification systems that undergird them, there is need for further study of 'design' and the living relationships between site, building and landscape in the city. Through a series of diagrams, details and photographs, this paper presents field research of a topologically complex hillside site that introduces new forms of dwelling and inhabitation in the city. With increasing need for meaningful, livable, interconnected, and humane urban housing, the intent of this research is to uncover the principles and strategies employed in an effort to re-establish novel solutions for addressing the growing need for healthy, open, and transformative urban housing.

**KEYWORDS:** Environmental Architecture, Tangling, Interconnectedness

## INTRODUCTION

In 2018, Japanese architect Akihisa Hirata in collaboration with structural engineers Masato Araya and Atsuhiko Sao of Oak Structural Design Office introduced a novel stepping galvanized steel frame system for the construction of three intertwining living units on three different levels on a small, corner sloped lot in Minami-Otsuka, Tokyo (see Fig. 1). In this fluid residential-vegetal eco-system comprised of three overlapping, staggered houses, the building-landscape opens up to the outside world, using green areas as extensions of living space while simultaneously connecting with the neighborhood beyond. The rotating slope of the corner site creates a system of forces that rise and revolve. The alternation of interior and exterior spaces of construction and vegetation in relatively stable equilibrium is what Hirata calls 'karamari-shiro' or intricate compatibility.



**Figure 1:** Hillside Tri-Plex, Overlap House, Akihisa Hirata Architecture Office, 2019

## 1.0. OVERVIEW

### 1.1 Premise

Since the 1960's, environmental science has formed the central part of ecological discourse in architecture. It has been the primary force behind the work of various leaders in the ecological design community (e.g. Knowles, Fisk, Van der Ryn, Dunster, McDonough, Addington). Gravity and the second law of thermodynamics set the stage for disseminating an array of scientific lessons. Energy is plotted. Solar angles are graphed. Gravitational forces are registered. Thermal flows are measured. Comfort is mapped. These science-based methods are fundamental to producing the various shades of green in the plans and sections of our buildings. Evidence of such is well documented.

### 1.2 Research Problem and Questions

Are scientific methods enough? According to urban theorist Dolores Hayden, not even a hundred-million new solar houses could lead to sustainability. In this paper, the following research questions are posed: Is sustainable design not solely a question of material science, technology and building systems, but also a theoretical question for architecture and the city? What defines the production of a dialogic space between environment and people? What are the spatial



possibilities for a vibrant exchange between ecology and urbanity? What can the hillside configuration of Hirata's Overlap House teach us about living in an urban environment? With increasing need for livable and humane urban housing, the intent of this research is to examine the principles and strategies employed in the work of Akihisa Hirata in an effort to better understand novel concepts and solutions in addressing the growing need for healthy, open, livable and transformative urban housing. Results from this study suggest that an integrated environmental architecture involving the complex "entangling" of interior and exterior space remain an untapped source of inspiration for social and environmental innovation.

## 2.0 BACKGROUND AND EARLY INFLUENCES

### 2.1 Raised Near the Sea

Akihisa Hirata was born in 1971 in Ōsaka, the second largest metropolitan city in Japan (20 million residents), located in the Kansai region of Honshu. An archipelago, Japan is comprised of 6,852 islands, 430 of which are inhabited. Japan is the fourth-largest island country in the world and Honshu is the largest of five 'main islands'. Ōsaka means "large hill" or "large slope" and the sea is omnipresent. Hirata grew up in a planned community on the edge of Ōsaka Bay. His proximity to the sea and the city influenced his interest in becoming either a biologist or an architect (see Fig. 2). Inspired by clouds and bubbles, steel and concrete, one could say that he found a way to do both. What drives Hirata, however, is not purely abstract or academic. Nor is it aesthetics. Hirata is searching for a conceptual grounding that engages the environment with the public. For Hirata, the central problem at play is reconstructing the relationship between architecture, people and all living things.

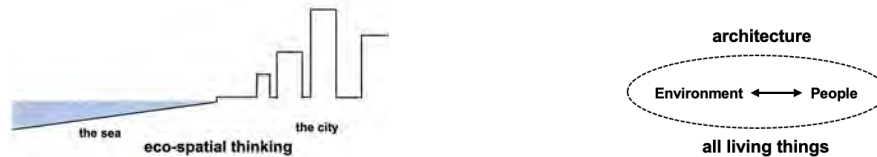


Figure 2: Akihisa Hirata, Conceptual Grounding in Eco-Spatial Thinking

### 2.2. Kyoto University

Hirata studied architecture in the Graduate School of Engineering at Kyoto University (M.Arch. 1997, B.A. 1994). The faculty at Kyoto position architecture as a 'synthetic system' for supporting multi-functional living space. This notion of space as "living" and the development of strategies for "bringing living things together" in a systemic way would serve as the foundation to Hirata's approach to architecture.

### 2.3 Toyo Ito and Associates

After seeing a model of Sendai Mediatheque, an entirely new type of public environment defined by thirteen super-sized latticed tube steel columns that "tilt like seaweed underwater," Hirata pursued a job as a 'kohai' or intern at Toyo Ito and Associates. He became involved in numerous projects including Tod's Omotesando and Ghent Forum for Music, Dance and Visual Culture (with Andrea Branzi). Though Hirata only intended to stay for a short while, he remained in Ito's office for eight years before leaving to launch his own practice.

## 3.0 BEGINNING A PRACTICE

### 3.1 Early Projects



Figure 3: House H, Osaka, Japan (Unbuilt), Akihisa Hirata Architecture Office, 2005

In 2005, Hirata established Akihisa Hirata Architecture Office. His first independent project was House H, a new home for his parents (see Fig. 3). H is located in Ōsaka in a residential area along a slope. Instead of following the conventional method of placing a square volume on a square-shaped site, Hirata juxtaposed various elements onto one another. Different spaces overlap and exist simultaneously, forming a new sense of order and spatial complexity.

This arrangement set forth a diverse relationship among the inhabitants. For Hirata, the living environment is neither a house nor an ensemble of rooms. The way each of the living spaces are arranged allow individuals on different levels to view other spaces above or below them from different perspectives. Despite his parents decision not to build the house, the project was awarded Japan's prestigious SD Review prize.



**Figure 4:** Masuya, Niigata, Japan, Akihisa Hirata Architecture Office, 2005

In need of wage-earning work, Hirata entered an internet-based competition for a showroom in Niigata, Japan, sponsored by Masuya Co, a farm equipment business (see Fig. 4). The minimalist design employing poured-in-place concrete construction was bold, geometric. The structure is a simple 5 meters grid, with diagonally placed walls, creating an “infinite degree in between “open” and “close”, so that one can feel the complex effects of 3-dimensional combination of these lines, which remind us some kinds of natural environments as forest”. The showroom has big windows, that allow the light to come inside from different angles, creating a diffuse ambiance. The interior features an open space that contains the exhibition space, a small cafe, and an office with a place for meetings. The floor plan has only 8,870sf but is efficiently distributed. The building is an interesting presence both at day and by night due to the light-filled open spaces and solid diagonal walls. It seemed unlikely that a dealer in tractors and snow blowers out in the sticks would agree to Hirata's unconventional design. Yet the young designer received the commission and with that his practice was off and running, and has since won received numerous awards.

### 3.2 Later Projects

R-Minamiaoyama (2006)	Coil (2011)	Art Museum & Library (2017)
House S (2006)	Long House (2011)	Tree-ness House (2017)
Sarugaku (2007)	Kotoriku Apartment (2014)	Taipei Roofs (2017)
Kodama Gallery, Gallery S (2008)	Higashi -Totsuka Church (2015)	Overlap House (2018)
Alp Apartment (2010)	Kamaishi Nursery School (2015)	Sendai Tree (2020, proposal)
Yoshioka Library (2011)	Taipei Complex (2016)	9h Hotels (2018-present)

In addition to his practice, Akihisa Hirata is currently a specially-appointed associate professor at the Tohoku University and a part-time lecturer at Kyoto University and Tokyo University.

## 4.0 EMERGING THEORY AND CONCEPTS

### 4.1 Tangling

Hirata belongs to a new generation of Japanese architects, who demonstrate significant new approaches to architecture and its relationship to the natural world, building upon the work of Japan's previous ‘young generation’, including Kazuya Sejima, Shigeru Ban and Jun Aoki. For Hirata, “The architecture of the future should be linked to the nature of living things. Architecture is the realization of new horizons that are not only linked to the vast expanse of architectural history, but also to the history of the human race and life itself.”



**Figure 5:** Tangling Exhibition, The Architecture Foundation London, Akihisa Hirata, 2012

Interested in creating simple and elegant geometric solutions that emulate and abstract nature's millions of years of

experience – pitched roofs that mimic mountain ranges, housing clusters that echo trees – Akihisa Hirata sees architecture and ecology as a complex, interwoven tangle, in terms of form, function and the relationship between the built and the natural (see Fig. 5). His designs rigorously explore future possibilities for architecture and structure. Hirata has distinguished himself producing works inspired by the complex relationship between architecture and ecology, using his theory of “tangling”. For Hirata, “tangling is the conceptual word to create architecture as a base of entanglement between people, living things and the natural environment.”

#### 4.2 Karamari Shiro

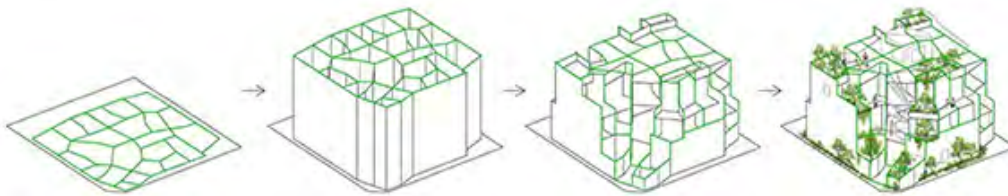
Akihisa Hirata’s architecture embodies the ideas of “karamari shiro,” or what he calls intricate compatibility. Breaking away from the borderless and endless expansion of spaces embraced by recent architectural practitioners, Hirata creates layered, nested spaces reminiscent of the natural environment. For Hirata, architecture is a living, breathing, transforming thing, an integral part of nature, not distinct from it. In his work, Hirata seeks to bring together the material world of nature and architecture, the vegetal and industrial, in meaningful new ways. Nature, in its physical presence and existential qualities, drives him to give space an intriguing duality.

#### 4.3. Human Nature

For Akihisa Hirata, architecture is an entire ecology where all beings are interrelated. Similar to the cities we live in, architecture contains the process of change or evolution resulting from the interplay between manmade objects and organic elements. Hirata’s exhibition, “Human Nature” (2019) speaks to the complexity and diversity of the environment. In this context, the word “human” refers to worldly, humane or intrinsic properties and not the opposite of or separation of “nature”. Within different contexts, “human nature” can mean “existence in worldly nature,” “synthetic nature,” or “genuine nature.” Its susceptibility for multifaceted interpretation and ambiguity open up possibilities for Hirata’s encompassing design. “Human being is a species of animal and function like microbes during fermentation on the earth’s crust.” Hirata seeks to consciously subdue human subjectivity in order to observe the relationship between beings and their environment through a micro-perspective to a macro-view.

### 5.0 TWO HOUSING PRECEDENTS

#### 5.1 Kotoriku



**Figure 6:** Concept, Kotoriku, Tokyo, Japan, Akihisa Hirata Architecture Office, 2014

Hirata looked to the form of the neighborhoods’ irregular roads and city blocks to set the design approach for a 12-unit apartment building known as Kotoriku (see Fig. 6). Located in a natural valley surrounded by taller buildings, Kotoriku is designed as part of the existing topography in the form of a small hill sunken into a valley. The structure comprises stepped concrete walls that encircle the site. Layers of radically different floor plans resembling Voronoi diagrams define the different living areas. Kotoriku explores the concept of connecting the interior with the exterior with shared open public spaces and a central staircase that connects the different units. Each apartment has its own exclusive floor plan, materials, and geometry. Every space combines a mixture of textures. For Hirata, each floor is understood as a little city, with its own unique areas and relations with the outside world. Each space is unique in size, condition, and shape, which defines the apartment’s character. Influenced by the 2011 earthquake in Tohoku, Hirata shares the same feeling as many other Japanese architects that buildings should have a more positive relationship with their environment. Buildings, at their most fundamental level, should provide opportunities for their inhabitants to connect with each other.



**Figure 7:** Collective Housing, Kotoriku, Tokyo, Japan, Akihisa Hirata Architecture Office, 2014



The organization of the apartments is based on an organic grid responding to a mix of different city streets in the area (see Fig. 7). Hirata summarizes the complex, with its green, public-like exterior, as “a mass of land, melted in order to organize it into something akin to living in a cave.” He adds, “...my idea of tangling, in-between interior and exterior, is a shared value in Asian thinking, resulting in a kind of ecological architecture that reflects how life makes itself.”

### 5.2 Tree-ness House

Built for gallery owner Taka Ishii, Tree-ness House makes full use of the narrow, deep lot. Functioning as a series of concrete boxes stacked on top of one another, some left open to introduce folds and voids where interior and exterior entangle and intertwine (see Fig. 7). The inspiration for Tree-ness House, like its name, is a tree. A tree consists of different parts such as roots, a trunk, branches, leaves and flowers, but these parts are not totally independent. The trunk and leaves differ in appearance, but are very similar in their basic structure – their inter-relationship creates a kind of nested or layered organic structure. It is possible to create an architectural logic that creates a similar organically layered and “tangled” structure, in which “the inside and outside are reversed multiple times”. The design of the Tree-ness House seeks to develop this new architectural principle, with the intention of creating a complex ecosystem connected to the city.



Figure 7: Tree-ness House, Toshimaku Ward, Tokyo, Japan, Akihisa Hirata Architecture Office, 2017

“The trunk and leaves differ in appearance, but are very similar in their basic structure — their inter-relationship creates a kind of nested or layered organic structure. It is possible to create an architectural logic that creates a similar organically layered and ‘tangled’ structure. The design seeks to develop this new architectural principle, with the intention of creating a complex ecosystem connected to the city.”

Hirata’s vertical housing collective contains various types of irregular-formed units, distorted windows and projecting, sun-seeking vegetal balconies (pleats), creating “a complete tree” as an organic structure.

## 6.0 OVERLAP HOUSE

### 6.1 Context and Climate

Japan lies in the humid subtropical climate zone with hot humid summers and generally mild winters with cool spells. Annual rainfall averages nearly 1,530 millimeters (60.2 in), with a wetter summer and a drier winter. Snowfall is sporadic, but does occur almost annually during the months of January and February.

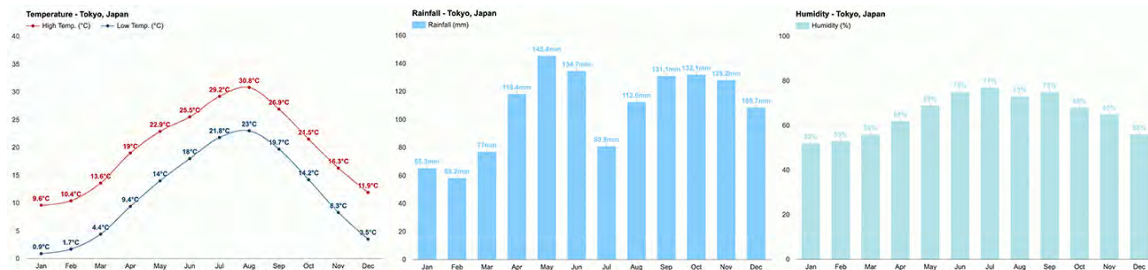


Figure 8: Average Temperature, Rainfall and Humidity, Tokyo, Japan (weather-atlas)

Arguably, the concept of entangling interior and exterior is dependent on the climate. In Tokyo, the warmest month is August with an average maximum temperature of 30°C (87°F). The coldest month is January with an average maximum temperature of 9°C (49°F). September is the wettest month, December is the driest month and January has more sun-hours than any other month of the year (see Figure 8). The Tokyo climate makes the city vulnerable to typhoons between June and October. Originating over the Northwest Pacific Ocean, these severe storms, which generate potential risk to Tokyo, are capable of creating fierce winds and intense rains.

## 6.2 Site and Building Organization

The Overlap House is located on a 1,260sf corner lot at a disjointed intersection of four streets in the district of Minami-Otsuka in northwest Tokyo. The district is characterized by high residential density, with very small distances between homes and practically no space between properties, a condition characteristic of the entire city of Tokyo that normally leads to the design of highly introverted buildings with practically no openings onto the outside world, denying any dialogue or relationship with it. Noting the paradoxical sense of isolation generated by homes of this type, that alienation in which we have no idea who our neighbors are, Hirata makes an unusual choice. He completely rejects this approach, metaphorically bringing the city right into the new building through its composition, materials and color. The compact tri-plex is the result of stacking and overlapping three houses on three different levels (see Fig. 9). The total floor area for the three houses combined is 1,915sf. By extending the presence of the slope, each house its own private garden. Inspired by the idea of the site as a body transformed in time and place, the slope of the ground entangles itself with the slope of the roof, establishing a productive ambiguity of interior and exterior.



**Figure 9:** Overlap House, Minami-Otsuka, Tokyo, Japan, Akihisa Hirata Architecture Office (2019)

The centrifugal forces of the site, twisting and rising, produce an intricate compatibility between program and site. The concept of urban stratification reveals territorial policies of the site, relations among neighbors and memory of place. The stepping vegetal pleats in Tree-ness House have transformed here into sunken and elevated green and blue spaces in the Overlap House. The gardens on the second and third levels are the green roofs of the first two units. The project's level zero corresponds to the southwest corner of the lot, where a steel staircase revolves around the building, leading directly to apartment C. The door to house A is at -150 mm, while that of house B is at +2700 mm, and an internal staircase links the living room level and the eastern part with the kitchen and bedrooms (see Fig. 10).



**Figure 10:** 1st, 2nd, 3rd Floors, Overlap House, Minami-Otsuka, Tokyo, Japan, Akihisa Hirata Architecture Office (2019)

Apartment A is located slightly higher than street level, and as the site is on a slope, it has direct access to the street on the eastern side through its garden. Apartment B may be accessed via a path rising onto the roof of house A. All the interiors include a living area which overlooks the garden via a glass wall, a more private study, bathrooms and a master bedroom. Each apartment is accessed via its own pathway, without being able to see into the other units, to respect each person's privacy. The building opens up to the outside world, using green areas as an extension of living space and simultaneously as a connection with the neighborhood.

## 6.3 Natural Systems



**Figure 11:** Natural and Social Systems, Overlap House, Tokyo, Japan, Akihisa Hirata Architecture Office (2019)



Sun, wind and rain are embraced sectionally. Given 55" inches of average rainfall per year, each apartment and its associated roof surface collects rain through an integrated system of gutters and discharge ports, depositing rain into one of three gardens, one for each apartment. Garden A has two discharge port areas equal to 150sf; Garden B has a discharge port area of 290sf; and Garden C has a capacity to absorb 310sf of rainwater (see Fig. 11).

The unfolding sectional rendering above illustrates the built-in topology of the design, composed of surfaces, rooms and voids that produce an intricate compatibility between social and environmental life. Interior rooms extend out to terraces and gardens. The slope of the land creates a system of forces that rise and revolve, made evident by the alternation of full and empty spaces of vegetation and construction (see Fig. 12). Daily life takes place outdoors as much as it does indoors. In the Overlap House, Hirata bridges privacy and publicity, socially and environmentally. The building is both figure and ground, cubic and porous, solid and arid.



**Figure 12:** Entangling, Overlap House, Tokyo, Japan, Akihisa Hirata Architecture Office (2019)

#### 6.4 Vegetal Industrial

The Overlap House translates the chaotic city of Tokyo, with its road signs, street poles and tangles of wires strung between them, into the natural disorder of gardens which “cling onto” the light metal structure: galvanized steel beams and pillars form a rectangular checkerboard of 2700 x 2700 mm units, bare sheet metal profiles and structural plywood. Galvalume gardens reflect draping greenery producing a public urban spectacle of garden-integrated apartment living. Big glass surfaces ensure continuity between the gardens and the living area in each apartment, prolonging the view from the outside into the house and vice versa.

The garden blends into the parklands, the house blends into the city and the barriers between each are atmospherically blurred, though physically present. The part to whole relationship cuts across scales, from the room to the garden, and from the garden to the city. Building and landscape slip and slide and fold by and into each other. The garden projects into the house and the house projects into the garden. Solids and voids intermingle. For the residents of each of the three houses, the streets, roads, nearby gardens and neighborhood parks feel as if they are an extension of the residence, notably providing a feeling of spaciousness and connectedness. Lightness, transparency and permeability define the intrinsic dynamism of a vegetal-industrial structure that carries with it a bold presence in the neighborhood.

#### 6.5 Surface

Surrounded by a sea of neutral façades and tiled buildings responding to fire protection regulations in Minami-Otsuka, the preference for clean white would have existed in stark and jarring contrast to the suburb’s topography. It was quickly evident that a different approach would be needed. Hirata set out to carefully study the various colors, materials and textures of the buildings in the neighborhood (see Fig. 13). The effort served to further explore his part to whole relation between the building and the city, and to simultaneously to identify additional layered strategies to integrate and coalesce the building into its neighborhood.



**Figure 13:** Context Coloring Siding, Overlap House, Tokyo, Japan, Akihisa Hirata Architecture Office (2019)



The roof and walls are covered with thin sheets of slate forming a motif that imitates the casual coloring of the surfaces in the neighborhood: warmer, earthy hues at the bottom, more greens, greys and blues rising upwards, in a succession of colors methodically organized using an algorithm. The mottled color gradually changes in accord with the color gradation of the ground, city and sky. "Breathing life into the city," Hirata's Overlap House is not simply a single, one-off architectural episode but an idea that constitutes a theoretical model of intricate compatibility.



**Figure 14:** Interior-Exterior, Overlap House, Tokyo, Japan, Akihisa Hirata Architecture Office (2019)

## 6.6. Ideas, Principles and Strategies

The Overlap House demonstrates Hirata's ideas and design for an open, transformative and transactional environmental architecture, a vibrant exchange between ecology and urbanity. His reverence for and theoretical investigations of nature and the natural world have led to complex concepts of tangling and karamari shiro. These concepts lead to open, covered exterior spaces, space reversals, rotational plans and sections, metallic and vegetal integration, and ambiguous orders of publicity and privacy (see Fig. 14). The manner in which Hirata has conceived, designed and built the Overlap House hold several valuable lessons for the design of future urban housing, particularly relevant in subtropic climates:

### Ideas and Principles

Architecture is Part of the Natural World  
Architecture is Linked to the Nature of Living Things  
Architecture and Ecology as a Complex Tangle  
Eco-Spatial Systems Thinking  
Positive Relationship with the Environment  
Architecture as an Urban Ecosystem

### Spatial Strategies

Interconnected and Interdependent Parts  
Indoor and Outdoor Reversals  
Part to Whole Relations Across Scales  
Adaptable and Flexible  
Multiple and Intertwining Ground Planes  
Vegetal and Industrial Interplay

Japan pledges to reduce greenhouse-gas emissions to net zero by 2050. Patents for new "carbon sink" technologies are abound. Services like LEED and IgCC are but two of a dozen certification systems for buildings. Evidence of such is well documented. But are new manufacturing methods and certification systems enough? In "Architecture and the Death of Carbon Modernity," Elena Iturbe argues that decarbonization is not solely a question of technology and building systems, but also a theoretical question for architecture and the city. Akihisa Hirata is one of new generation of architects in Japan interrogating questions about architecture and the city ~ not as a series of material inputs and outputs, but in seeking to produce a more fundamental, interconnected, and meaningful spatial experience between people and place, between architecture and the city and all living things.

## 7.0 CONCLUSION

In Tokyo, there is just 33sf of parkland per person, compared with 290sf in London and 310sf in New York. Japan's urban greenery has been gobbled up due to soaring land prices, shortsighted construction policies and punitive inheritance taxes. By 2030, the World Resources Institute says that greater Tokyo will easily be the biggest "megacity" in the world. What kind of place will it be? Akihisa Hirata is one of a number Japanese architects who have ideas about creating a brighter, gentler, more humane Tokyo in the next few decades. And gardens are a vital part of their vision. In lieu of potted plants distributed along the street, sidewalk or window sill, Hirata's vision for a new relation between architecture and living things opens the door to completely new ways of thinking about the life-giving, richly interconnected possibilities between nature, city and building ~ what Hirata calls, intricate compatibility.

## REFERENCES

- (1) Naomi R. Pollock, FAIA. December 16, 2013, Architectural Record
- (2) The lower position in the Japanese apprentice hierarchy, equal to intern or junior, gradually moving up to sempai (tutor or intermediate) and eventually sensei (master).
- (3) 19<sup>th</sup> Japan Institute of Architects Newcomer Prize
- (4) JA 108 (Japan Architect), Akihisa Hirata: 2003-2017, Winter 2018
- (5) Fumihiko Maki, City with a Hidden Past (translated H Watanabe), 2018
- (6) Radovic, D and Boontharm, D, Small Tokyo: Measuring the Non-Measurable, IKI Press, 2012
- (7) Schittich, C, Housing in Japan: Typologies for Small Spaces, Detail IIA Press, 2016

# Synoptic Optics: Computational Representation at the Synoptic Scale

Stephen Mueller<sup>1</sup>

<sup>1</sup>Texas Tech University, El Paso, TX

**ABSTRACT:** *Synoptic optics* is a design research initiative that seeks to construct armatures for enhancing and augmenting the observation of airborne particulate to enable a more immediate, public, and actionable understanding of the impact of dust at urban and territorial scales. The project includes two parallel and complementary objectives: the design of novel computational mapping strategies to assist spatial practitioners in detecting and evaluating the geography of airborne dust, and the design of novel representational strategies to sensitize urban populations to shifting atmospheric conditions with impacts on public health. Using open-source geospatial data, a geomorphologic model of the borderland is developed and dissected through a custom algorithmic *circular sectioning* technique. A *panoramic horizon map* compiles the concentric sections, yielding a *synoptic view* of the expanded territory as seen in deep section from a single observation point in all directions. The concentric horizons calibrate the entangled geomorphological properties of landform and atmosphere. *Spherical projection techniques* sample and remap the sky dome, extrapolating the impacts of wind data to articulate the likely trajectories of particulate from nearby point sources.

**KEYWORDS:** computational mapping, computational representation, environmental justice, environmental health, border urbanism

## INTRODUCTION

### Challenges of representation at the synoptic scale

The term “synoptic,” borrowed from meteorology, here designates a scale of atmospheric phenomena between the urban and the territorial, in which anthropogenic activities and climatological events co-produce significant effects on urban populations. Large dust storms are one common type of *synoptic event* with significant impact on public safety and environmental health.<sup>1</sup> In the project study area, massive clouds of suspended airborne particulate regularly traverse the desertifying US-Mexico borderland, suspending fine particles in the atmosphere above major urban centers, posing great risks to borderland populations.

Architects and planners serving populations impacted by *synoptic events* such as these have limited capabilities to detect, represent, and evaluate atmospheric events with precision at the urban and territorial scale. At the same time, urban populations are largely unaware of the significant threats to human and environmental health such events might cause, unassisted in viewing and interpreting their arrival, under-informed about the sites and geographies within and around their cities with the greatest contributions to such events, and unprotected against their negative impacts.

To better assess and counteract harmful synoptic effects, we must increase both the disciplinary capacity for synoptic observation, and the means by which these observations are represented and communicated to the public they are meant to serve. Spatial researchers conducting territorial investigations to identify and ameliorate the source of harmful dust suspension are challenged by both technical and disciplinary limits. Scientific assessment methods<sup>2</sup> require expensive equipment and post-event processing workflows requiring expertise beyond the capacities of planners and architects. The public, and public agencies, meanwhile have limited tools and resources available to understand and respond to changing synoptic events.

Compounding these challenges is the elusive visual quality of dust itself. Individual dust particles can easily evade human detection, while larger concentrations of suspended airborne particles evade notice as well, leaving substantive and insidious threats to public health all but invisible. Despite the relatively sensitive capacities of the human eye to detect subtle differences in light and color, harmful daily levels of suspended particulate go unseen. Smooth, gradual, changes in the amount of atmospheric dust throughout the day can trick the eye into reading an unchanging—and presumably healthy—condition. Gradual changes in the amount of atmospheric particulate in one part of the sky compared to another can similarly go unobserved. Layered haze, for instance, is much easier to discern than uniform haze, due to the human eye’s heightened ability detect sharp demarcations of brightness or intensity and relative ineffectiveness at distinguishing subtle gradations. Changing light conditions can also obscure the presence and impact of airborne particulates. High sun angles will reduce the amount of scatter and increase illumination and detail of the scene, rendering a highly particulate-infused territory relatively clear compared to the same territory when viewed under

low sun angles (Malm). Additional problems identifying the sites with the most impact on visibility, which themselves can elude detection. While a large seasonal dust event may be visibly apparent to the casual observer, the particular sites and geographies contributing the event can be more difficult to discern. Plumes and point sources are not all easily identifiable depending on their intensity and spread.

### Visualizing visibility

*Visibility* is a measure of the impact of atmospheric conditions—including the presence of airborne particles—on the ability of an observer to view an object. Spatial researchers, public officials, and the public at large intuitively understand *visibility* as a reliable index of environmental health. A dramatic change in visibility in a given environment is a good indicator of changing threats to public or individual health. Individuals will often modify their behavior and their degree of outdoor exposure to mitigate risks when air quality is visibly poor. A major problem occurs when visibility conditions are an unreliable indicator of exposure risk to pollutants and other harmful particulates, and the mitigating response is limited.

When visibility is an unreliable indicator, individuals can rely on air quality reports for their metropolitan region to further assess exposure risks. But these reports provide broad assessments of risk at coarse temporal and spatial scales and may not reveal the asymmetrical distribution of air quality common to most urbanized regions. Further, these assessments are largely divorced from the immediacy of human sensory experience that visual observation affords, as they rely first on instrumented observation and measurement to gather data, and second on the intentional access of that information through apps, channels, or stations.

## 1.0 OBJECTIVES

The project endeavors to augment human sensory perception of subtly varied visibility conditions with the aid of computational mapping and representation strategies. Through the use of digital modeling, simulation, and computation, we seek to create a series of data-driven graphic outputs that construct a *territorial visibility index* – an aid to human optical perception to better interpret, predict, and respond to changing visibility conditions. This collection of quantitative and qualitative graphics summarizes the environmental, optical, and geophysical conditions contributing to changing visibility conditions within a synoptic territory. The project seeks to develop computational mapping tools and techniques useful to spatial researchers engaging with issues of visibility and airborne particulate in urban environments, and to develop computational representation strategies to expand the suite of informational maps, drawings, and graphic to convey actionable data to a broad public.

## 2.0 METHODOLOGY

The research methods include the development of the following computational mapping tools and computational representation techniques to produce the *territorial visibility index*.

### 2.1 Orthographic vs. circular sectioning

The first technique developed for the project is a computational drawing technique of *circular sectioning*, which helps to assess the impact of topographic data on *visibility* by arranging that data in a new—and newly useful—configuration. To better understand the advantages and approach to this technique, we will first compare to the more traditional technique of orthographic sectioning and highlight its advantages for this application.

The *orthographic section* is a familiar drawing type in both architecture and landscape architecture, helping to capture the shape, height, and internal composition of a given form or topography as it is sliced by an imagined section plane. The orthographic section can be imagined as the intersection of a two-dimensional plane with a given form. Projections to this section are parallel, originating from a plane of projection. The technique provides a measurable drawing which indexes the exact height of each element within the section profile (measured along the Y-Axis of the drawing), as well as any width parallel to the section plane (measured along the X-axis of the drawing).

A *circular sectioning technique* can be imagined instead as the intersection of a *cylindrical extrusion* with a given form. Projections to this section are radial, originating from an *axis of observation*, a line coincident with the vertical axis of the imagined cylinder. This technique, similar to orthographic sectioning, indexes the exact height of each element in the section profile (measured along the Y-Axis of the drawing), but captures the *polar* (or cardinal) *orientation* of elements plane (measured along the X-axis of the drawing).

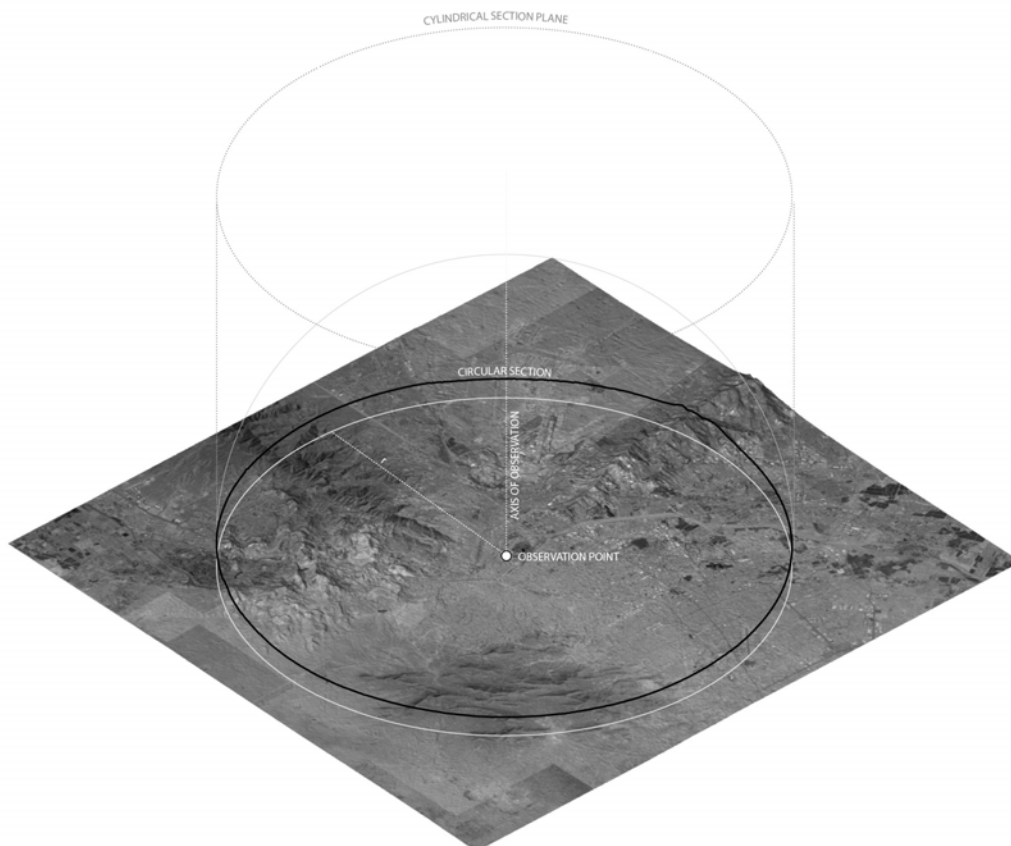
In *orthographic sectioning*, height and profile information is captured in one direction at a time. In *circular sectioning*, height and profile information is captured in all directions simultaneously. The *circular sectioning technique* helps us to imagine and document the complex geophysical reality of a large territory in a single drawing. With an infinite number of radial projections extending 360 degrees from the cylindrical axis, we can capture any horizon we choose.

The precise plane of projection for an *orthographic section* yields relatively little influence on the projected drawing. An infinite number of parallel planes of projection exist which could produce the same orthographic drawing. The orthographic section drawing does not imagine or indicate a position in space except insofar as it indexes which side

of the section plane the projection plane lies, evidenced by which direction we see through the form.

The *circular sectioning technique*, on the other hand, helps us to imagine and draw from a singular position of a unique observer, located by the position of the vertical axis of observation in XY space. Changing the position of the axis, even slightly, yields radically different results for the circular section. This reciprocity and fluid interchange between the position of the imagined observer and the resulting drawing is critical to the drawing's success in capturing qualities of visibility, which are dependent on spatial factors like position and orientation of view as outlined above.

Unlike orthographic sections, which cast the analyzed form in front and apart from an observer, in circular sectioning, the territory is redrawn as it *surrounds* an observer. Instead of merely describing locational and metric data, this technique allows for both directional and relational information to enter into the drawing.



**Figure 1:** Circular Sectioning Diagram. Source: (Mueller, 2020).

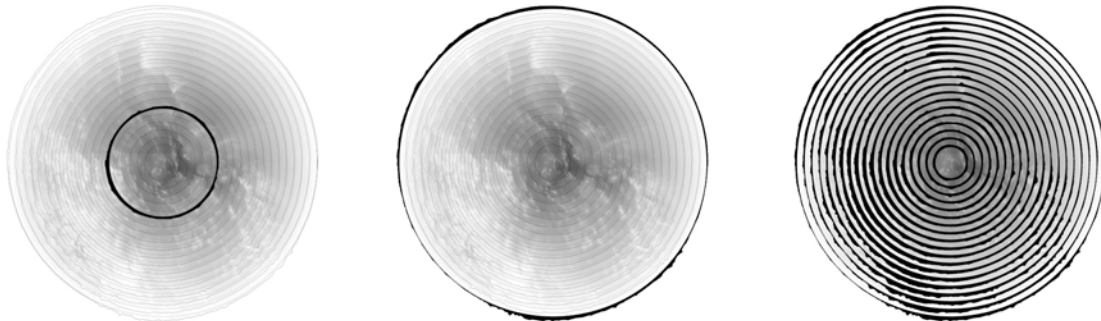
## 2.2 Circular sectioning algorithm

To achieve the circular sectioning technique, a *circular sectioning algorithm* (Fig. 1) was developed using Grasshopper/Rhino. First a geomorphological mesh model of the study area was created using digital elevation model (DEM) information imported into the software. Next an observation point was identified on the topography. From the observation point, the axis of observation is drawn vertically. A *horizon distance* (the distance from the observation point to the drawn section) is identified, which is used as the radius ( $r$ ) of the cylindrical section plane. A vertical line drawn both above and below the topographic model. The axis of observation is used as the axis of rotation to create a cylindrical revolved surface from this line. The intersection of the revolved surface with the topography is generated, creating a three-dimensional circular section.

The three-dimensional section is then translated from 3D space to the 2D planimetric picture plane by sequentially rotating points of the section *down* and *out* from the projected cylindrical plane. First the cylindrical section plane is projected as a circle in plan and positioned at the minimum height of the 3D section. This base circle is then subdivided into a series of sample points ( $P_c$ ), while the 3D section is subdivided into a corresponding series of points ( $P_s$ ). The height ( $h$ ) between each base circle point ( $P_c$ ) and its corresponding point on the 3D section ( $P_s$ ) is measured. Each height value is then used to translate each point on the base circle outward radially. The resulting translated points ( $P_t$ ) are then used to generate the translated circular section curve.

The resulting 2D curve shows an accurate depiction of the continuous topographic section at a given radius from the observation point. This *synoptic* image has great utility for the visibility study in the study area. The mountain peaks and valleys surrounding the urban environment are key factors in the effects of airflow on airborne particulate, as well as readily identifiable landmarks against which visibility impact will likely be judged. The varying heights of the peaks additionally impact the screening of sunlight in early morning and late afternoon and can have asymmetric impacts on visibility conditions depending on the location from which they are observed.

Importantly, the radius ( $r$ ) of the circular sectioning algorithm can be tied to the reported visibility at a given time or date, yielding an accurate depiction of the observable limits of the territory in a given atmospheric condition from a specified observation point. The maps can be read in space similar to the use of a star chart, by standing at the observation point and orienting the positive Y-Axis toward 0 degrees north.

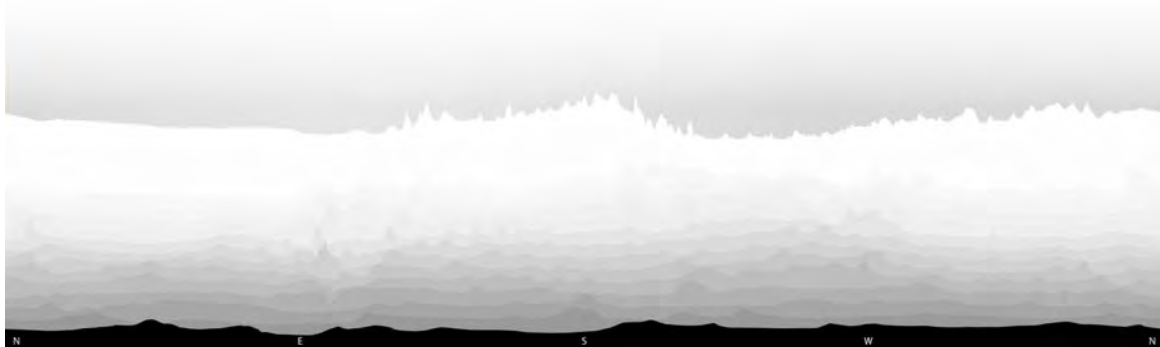


**Figure 2:** Circular Sectioning (Limited Visibility Index); Circular Sectioning (High Visibility Index); Progressive Circular Sectioning. Source: (Mueller 2020).

### 2.3 Progressive circular sectioning

The circular sectioning technique is then further expanded through the development of *progressive circular sections* (Fig. 2), generated by incrementally increasing the radius of the cylindrical section plane to capture a series of concentric sections. The resulting drawings help to elaborate the layering of impactful and identifiable topographic elements as they recede infinitely from an observation point. The drawings further indicate the multiple and variable limits of visibility in multiple directions from a given point.

Both the *circular sectioning* and the *progressive circular sectioning techniques* assist in translating geophysical conditions with impacts on visibility to a measured and measurable synthetic drawing type with the potential to increase the legibility of visibility issues at the territorial scale. To further these techniques' representative potential, we will now explore opportunities for additional translations and layering strategies.



**Figure 3:** Cylindrical Projection (Panoramic Horizon Map). Source: (Mueller 2020).

### 2.4 Cylindrical projection algorithm

A *cylindrical projection algorithm* (Fig. 3) can further translate the circular sections from the planimetric, graph-like-representation to a more experiential panorama-style drawing. The technique unrolls the sequential horizon profiles generated from the progressive circular sections and stands them vertically, as if in an elevation view. These horizon profiles are offset from each other vertically in order to read full elevational geometry of the model in all polar directions simultaneously.

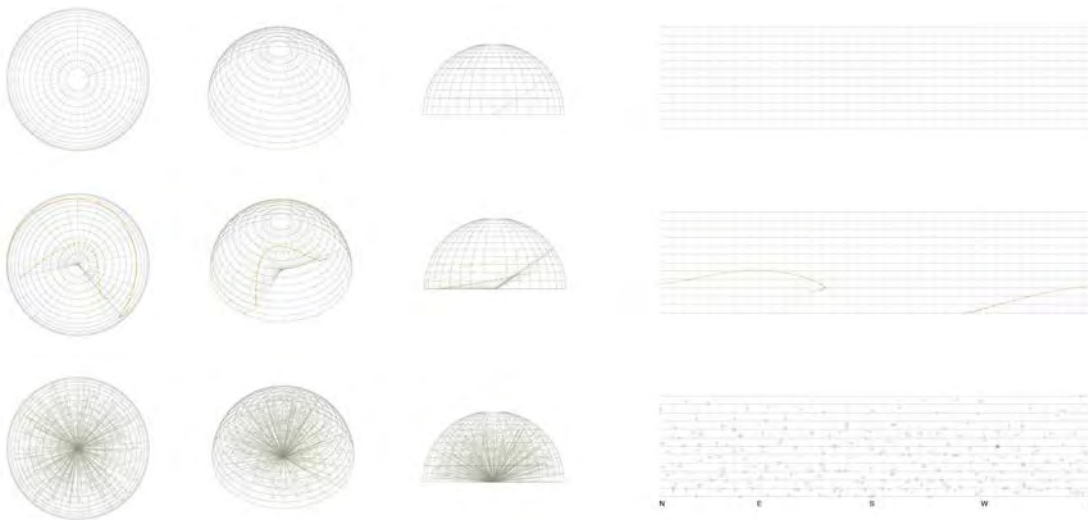
To accomplish the cylindrical projection, we again use sample points from the 3D section profiles (Ps). These points are then mapped to their corresponding sectional cylinder, and the surface (UV) coordinates of each point on the sectional cylinder is extracted. The cylinder is then unrolled to produce the projection plane for the cylindrical projection, where the width (X-dimension) of the projection plane equals the circumference of the sectional cylinder, and the height (Y-dimension) of the projection plane equals the height of the sectional cylinder. The UV coordinates of the sample points are then mapped to this projection plane, and a newly projected section curve is drawn through the points.

The projection plane is shown with North (0 degrees) at both the leftmost and rightmost edge—where the cylinder would be rejoined in a seam—and steps through polar orientations in series. East (90 degrees) appears at the first quartile, South (180 degrees) at the midpoint, and West (270 degrees) at the third quartile. To capture these topographic conditions critical to investigating visibility, the technique necessarily distorts human vision. The drawing distorts the apparent width elements as they recede from—or advance toward—the axis of observation. As the radius of the cylindrical plane increases, widths appear to stretch. As the radius decreases, widths compress.

The technique captures both singular and compound effects of topographic features, revealing not only individual peaks and valleys but the likely channels and obstructions of airflow passing through layers of such features. The anti-perspectival view allows drawing to radically collapse territorial distance and provide a basis for further comprehensive mapping of critical geographic features and sites. By offsetting each horizon profile the drawing can achieve seemingly endless clarity, precision and depth. The peaks and valleys which would obscure potentially critical conditions in a perspective view here are attenuated and able to be assessed in isolation.

Simultaneously, this mapping of the visual landscape retains readily-identifiable topographic profiles and other landform features, making the mapping more immediately and intuitively communicated to a public or untrained analyst. Readers of such a map, positioned in space at the observation point, can orient themselves in any of the compass directions noted on the map, or point themselves toward any of the recognizable landmark features to begin to translate the information captured to their situated perspective.

The visible, and visually obscured features of the landscape reveal themselves as a new ground on which to map and analyze the geographic and environmental factors affecting visibility. With these techniques in hand, the research then proceeds to develop capacities for positioning particles, pollution sources, and dust events within these measured representations.



**Figure 4:** Spherical Projection Algorithm: Top Row—Particle Data; Middle Row—Trajectory Data; Bottom Row—Particle Cloud Data. Source: (Mueller 2020).

## 2.5 Spherical projection mapping dust events

Finally, a spherical projection algorithm (Fig. 4) was developed to translate 3D positions and trajectories of airborne particles and dust events to a compatible representational mode. The spherical projection is capable of registering not only the polar direction from an observation point to a projected element, but also to accurately capture the angle of inclination to the element, which is important in assessing the potential impact on visibility as it relates to view angle and sun angle.



Similar to the use of the cylindrical surface in the cylindrical projection technique, a hemisphere was used as the projection surface for this technique, centered on and placed above the observation point. The hemisphere is similarly split along a seam at 0 degrees North, and unrolled into a rectangular surface for projection. The width (X-dimension) of the projection plane equals the circumference of the hemisphere, and the height (Y-dimension) of the projection plane equals the radius of the hemisphere. Polar orientations are read along the X-axis, while angles of inclination are read along the Y-axis, with the horizon at the bottom of the drawing and the zenith at the top.

Three test cases demonstrate the utility of the algorithm. The first and simplest case captures the three-dimensional position of a single hypothetical suspended particle. A projection line is drawn from the observer to the particle and extended until it intersects the hemisphere, generating a point on the hemisphere surface. The UV position of that point is extracted and translated to the projected rectangular surface. The distance from the observer to the observed particle is also recorded and used to control the size of the particle represented in the drawing, with closer particles appearing larger than those further away.

The second case studies the trajectory of an airborne particle over time. First a particle is animated using agent-based simulation techniques with wind data from local weather stations controlling its trajectory over time. Its position is recorded as it travels as a series of three dimensional points (X, Y, Z) in the model space, and a curve is drawn indicating its trajectory. Each of the points is projected to the hemisphere and translated to the projected rectangular surface as in the first case above. The trajectory curve is redrawn through the newly projected points.

The third case studies the utility of the algorithm in capturing point cloud data. Multiple points are simultaneously projected as in the first case above, and their distance from the observer recorded and translated through the scalar operation on the resulting graph.

### 3.0 RESULTS AND DISCUSSION

Preliminary graphic results from the computational mapping and representational techniques were developed for a test case in El Paso, where several neighborhoods near the international border are subject to reduced environmental air quality due to invisible airborne particulate and atmospheric pollution from idling truck traffic approaching the international bridges and other factors. The graphic results were able to help locate and orient community representatives to significant atmospheric pollution sources within the test area, and those outside the test area with impacts on air quality in the neighborhood. To provide more immediate and quantifiable results useful to neighborhood representatives and communicable to local policymakers, we plan to integrate the mapping strategies with data gathered from a suite of distributed low-cost air quality sensors capable of continuous monitoring and near real-time visualization, to capture the sudden shifts and changing hourly, daily, and seasonal conditions impacting air quality in the test area.

### 4.0 CONCLUSION

The techniques presented in this paper demonstrate the utility of computational mapping and representational techniques in capturing and communicating spatial and environmental information with impacts on visibility at the territorial scale. The techniques consider the impact of spatial relationships on conditions of visibility, and the effects of airborne particles and dust events on visibility conditions. Further, the techniques translate these compound and complex behaviors to digital design software, suggesting new approaches for spatial researchers and designers to engage with visibility, while also providing new modes of representation to communicate the impact of airborne particulate as a legible phenomenon to a broad public.

### ACKNOWLEDGEMENTS

Design research and drawings completed in part for “Breathing Territories” project, made possible by 2019 Prototyping Tomorrow Grant from University of Michigan A. Alfred Taubman College of Architecture and Planning. Project leads: Kathy Velikov (UMich), Geoffrey Thün (UMich), Ersela Kripa (TTU), and Stephen Mueller (TTU).

### REFERENCES

- Mueller, S. (in press-a). *Mapping territorial transgressions: synoptic tactics*. ACSA 109th Annual Meeting. Conference Proceedings.
- Mueller, S. (in press-b). *Irradiated shade: mapping, modeling, and measuring urban UVB exposure*. ACADIA 2020 Distributed Proximities. Conference Proceedings.
- Mueller, S. (in press-c). *Designing for irradiated shade*. ACSA 2020 AIA/ACSA Intersections Research Conference: Carbon. Conference Proceedings.
- Kripa, E., and Mueller, S. 2016. *Infrastructure of dust: managing particulate in the borderland*. Cross Americas: Probing Disglobal Networks, ACSA 2016 International Conference Proceedings.
- Malm, William C. 1999. *Introduction to visibility*. Vol. 40. Cooperative Institute for Research in the Atmosphere, NPS Visibility Program, Colorado State University.

### ENDNOTES

<sup>1</sup> See Kripa & Mueller 2016 for further detail including other urban and transboundary geographies impacted by airborne dust

<sup>2</sup> Polarization, the use of “free-space laser beams” or “evanescent wave detection,” and other instrumented augmentations can help tune observers to changing conditions in near-real time.

# Selective Attention and the Built Environment: Visual Perception of 2D Spatial Representations

Jennifer A. E. Shields<sup>1</sup>

<sup>1</sup>California Polytechnic State University, San Luis Obispo, CA

**ABSTRACT:** All modes of two-dimensional spatial representation are abstracted and framed views of three-dimensional embodied space and therefore subject to interpretation. Because architects use various modes of graphic representation in their design process and as tools to promote their designs to others, it is valuable to understand how people perceive an architectural space in different modes. The objective of a recent study was to compare how participants visually perceive photographs and drawings of the same architectural view, determining selective attention through eye tracking data. We hypothesized that there are differences between the features attracting attention in a photo versus a drawing, and differences in the attention of viewers with architectural training, suggesting that different modes of representation could be employed to draw attention to specific features of a design. This paper provides a brief background on visual perception and describes the methodology and outcomes of a recently completed study, which confirmed our hypotheses. Architecture students and Preschool students were shown either a photograph or a perspectival line drawing of Louis Kahn's Salk Institute for 30 seconds. While they looked at the image, eye movement data was collected. In addition to comparing how participants looked at photos and drawings of the same space, we evaluated an existing tool called saliency mapping, which claims to identify the visually dominant features of an image algorithmically. Our overarching research question we continue to pursue asks: Are there modes of representation for which visual perception closely correlates with that of an embodied architectural experience?

**KEYWORDS:** visual perception, graphic representation, drawing, photography, perspective

## INTRODUCTION

Architects employ various modes of graphic representation throughout their design process, as well as to communicate their ideas to clients and future occupants. Two-dimensional representations of three-dimensional space range from sketches, to orthographic or perspectival line drawings, to collages and renderings. The very act of flattening three-dimensional space into a two-dimensional image requires abstraction and interpretation by the viewer, thus opening it up to multiple interpretations by the viewer. This paper describes research into the visual perception of two-dimensional spatial representations.

### 1.0 PERCEIVING THREE-DIMENSIONAL SPACE

In the study of visual perception, it is understood that "Both the physical world and the perceptual world have structure" and can be defined geometrically (Hershenson 1999, 2). While the physical world can be described by Euclidean geometry, the geometry of the perceptual world, which is viewer-dependent, changes based on the location and orientation of the viewer. In the perceptual world, object attributes such as size, shape, movement, direction, and position vary (Hershenson 1999). The world we inhabit is three-dimensional – yet visual information about our world is interpreted by the brain through two-dimensional images, projected onto our retinas. The single image resulting from the synthesis of two different monocular images is called binocular fusion. The disparity between the two retinal images is what gives us cues about depth perception, or three-dimensional relationships between things. Architects are responsible for both the physical, objective, characteristics and measurements of their design, while visualizing the perceptual world that will arise from its construction.

#### 1.1. Cognitive Processes

With more stimuli in the environment than we are capable of processing, our perceptual system relies on two levels of processing to acquire the information we need.

*Top-down and bottom-up processing* refers to the integration of information from one's own cognitive system (top-down) and from the world (bottom-up) to facilitate perception (Carlson 2010, 1011).

*Top-down processing* uses our prior knowledge and expectations, influencing what we perceive. Viewing the environment with a specific task in mind is an example of this. *Bottom-up processing* refers to information we receive from direct sensory input. Aude Oliva, a professor at MIT, bridges human perception/cognition, computer vision, and cognitive neuroscience in her studies of visual perception. Her research investigates the processes by which we view

a scene or place. In a first glance at a scene,

...the visual system forms a spatial representation of the outside world that is rich enough to grasp the meaning of the scene, recognizing a few objects and other salient information in the image, to facilitate object detection and the deployment of attention (Oliva 2005, 251).

She calls this the *gist* of a scene. Additionally, she describes the role of memory in this assessment.

...people rely on their previous experience and knowledge of the world to rapidly process the vast amount of detail in a real world scene...Although we aren't aware of it, viewing a scene is an active process, in which images are combined with memory and experience to create an internal reconstruction of the visual world (Oliva 2010, 1111).

In every perceptual experience, both levels of processing are at work. We employ top-down processing to a greater extent when we are in a familiar place, and we rely more on bottom-up processing in an unfamiliar setting. Dual processing suggests that there are commonalities in how we visually perceive views of the built environment, but that our prior experiences and expectations will cause variations in visual perception.

## 1.2. Visual Perception of 3D Space in Drawings and Renderings

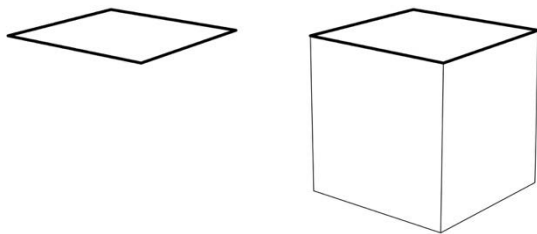
Top-down and bottom-up processing are also deployed as we look at two-dimensional representations of three-dimensional space. While architects and designers have graphic conventions for representation that are intended to communicate with others in related fields (like orthographic drawings), we commonly use perspectival drawings and renderings to communicate with clients, future users, and the general public. Perspectival drawings are intended to approximate how a three-dimensional space would be visually perceived by the human eye – the perceptual world as opposed to the physical world as defined by Hershenson. These drawings place the viewer into the imagined space. Rudolf Arnheim, in his book *Art and Visual Perception: A Psychology of the Creative Eye*, describes how we understand depth in a two-dimensional image. Perspective representation acknowledges a viewer: the distortion of the built environment occurs because there is a viewer and direction of view.

This explicit acknowledgment of the viewer is at the same time a violent imposition upon the world represented in the picture. The perspective distortions are not caused by forces inherent in the represented world itself. They are the visual expression of the fact that this world is being sighted (Arnheim 1956, 294).

Here, the measurable geometry of the world is transformed, in order to approximate a visual experience. He goes on to say:

Although the rules of central perspective produce pictures that closely resemble the mechanical projections yielded by the lenses of eyes and cameras, there are significant differences. Even in this more realistic mode of spatial representation, the rule prevails that no feature of the visual image will be deformed unless the task of representing depth requires it (Arnheim 1956, 286).

We look for geometric simplicity to reconcile two- and three-dimensions. Arnheim defines the *law of simplicity* as our perceptual desire to find the simplest structure. In the diagram below, we could see the left figure as an irregular quadrilateral shape, but it makes more sense (the shape indicates a simpler form) as a horizontal square in perspective (Fig. 1) (Arnheim 1956).



**Figure 1:** This diagram shows the interpretation of a form in two and three dimensions, based on Arnheim's law of simplicity. Source: (Author 2020)

The interpretation of a two-dimensional line drawing intended to represent a view of three-dimensional space adheres to Arnheim's principles. However, many designers use renderings – perspectival drawings with light and shadow, color, and materiality – to more closely approximate an embodied experience. Little research has been done on our visual perception of architectural space in perspectival views. Renderings offer less room for interpretation and imagination by the viewer than perspectival line drawings because more attributes have been assigned within the rendered image. Yet even in seemingly realistic renderings, the correlation between the perception of the attributes of the rendering and the attributes of the built work is unknown.

### 1.3. Visual Perception of 3D Space in Photographs

Although we recognize drawings and renderings as an architect's depiction of space, with photography there tends to be an assumption that it is an unbiased presentation of the space. Yet understanding the content and spatial implications of a photograph is a learned ability, and the photograph is, like a drawing, an abstraction of the architectural space. Studies comparing different cultures have found no difference in perceptual organization; however, these studies have shown that photographs are interpreted differently by different cultural groups (Weber 1995). For example, African aborigines - who had never seen a photograph before - could not recognize anything in photographs they were shown, which depicted spaces familiar to them. Two-dimensional representations of three-dimensional space require interpretation which "relies on acquired visual conventions that may be as arbitrary as linguistic conventions" (Weber 1995). Photographs are authored and abstracted depictions of architectural space in the same manner as drawings. The photographer chooses the lens (which may or may not be similar to the lens of the human eye, and so may show more or less of the space), the direction of view, and what to include in or exclude from the frame. In some visual perception studies a photograph serves as a stand-in for the real space, but the bias of the photograph is acknowledged. In order to better understand our visual perception of two-dimensional images, researchers often measure visual activity using eye tracking devices.

## 2.0. VISUAL ATTENTION AND EYE TRACKING

Eye tracking is a valuable tool to quantitatively and spatially document a person's visual experience. Eye tracking data includes fixations and saccades, based on movement of the fovea, the area of the retina where eyesight is sharpest. The fovea represents less than 2 degrees of the visual field, so the eye must move, or *foveate*, in order to take in detailed information (for example, in complex areas of the visual field). When the eye stops to take in information, this is called a *fixation*. The rapid movement of the eye from one fixation to another is called a *saccade*. During saccades, the eye is effectively blind: visual information obtained by the eye occurs during fixations, thus making fixations the most valuable data collected through eye tracking (Holmqvist 2011).

### 2.1. Eye Tracking to Measure Visual Attention to Art and Architecture

As early as the 1930s, psychologists were interested in how the eye moves and fixates when focused on a work of art, both with and without a given task. Guy Buswell, a psychologist who invented the first non-intrusive eye tracker, found that the eyes do not follow edges, but tend to scan and focus on central concave areas (1935). More recent studies confirm that fixations are likely to occur in concave and enclosed areas of a figure, rather than in what is perceived as negative space (Weber 2002). Alfred Yarbus, another pioneer in eye tracking research, found that eye movements vary when looking at an image depending on the task the observer was asked to complete (1967). His most famous study asked participants to look at a painting called *The Unexpected Visitor* seven times, first without a prompt and then six more times based on prompts. Questions included details of the painting like remembering the position of people and objects in the room, as well as narrative questions like estimating how long the visitor had been away from the family. The selective attention process caused participants to attend to certain aspects of the image while ignoring others. Elina Pihko's 2011 eye tracking study compared how laypeople and experts look at paintings, determining that in a perspectival painting, the laypeople tend to fixate on the center of the space while the experts view more of the painting. These studies demonstrate the impact of top-down processing on the visual perception of images.

While the visual perception of artworks has been investigated, there has been little study on the role of eye movement in the perception of three-dimensional architectural space. One of the few studies on this topic was conducted by Weber et al. (2002) in which they collected eye tracking data as participants were asked to look at either scaled three-dimensional models or photographs of models of architectural spaces. The research focused on comparing different arrangements of objects within a space. The results of this study show that without a given task (dominated by bottom-up processing), the eye is drawn to visual centers and distinct objects rather than tracing contours. "Elements indicating spatial depth, such as vistas, receive special attention" and "vertically and horizontally oriented objects are explored less than obliquely oriented shapes" (Weber 2002, 67). This confirms the *law of simplicity* proposed by Arnheim (1985), as we need time to process the meaning of angled lines in an image – do they indicate an irregular two-dimensional object, or a perspectival three-dimensional object? The results also confirm Buswell's conclusion that fixations are likely to occur in concave and enclosed areas of a figure, rather than in what is perceived as negative space (Weber 2002). This study shows that, when looking at representations of three-dimensional space, we attend to the features of the image that convey depth rather than to features of the image, like contours, that convey the two-dimensional composition of the image.

### 2.2. Saliency Mapping to Anticipate Visual Attention

The environment provides substantially more sensory stimuli than we can attend to. The human brain has adapted by selecting certain parts of the view to process preferentially. This allows the brain to register different areas of interest in a serial manner and shift from one to another. *Saliency mapping* is a technique first conceived by neuroscientists Laurent Itti, Christof Koch, and Ernst Niebur at the California Institute of Technology in 1998. It is a method of computationally analysing unique features in any given photograph and processing them to highlight the anticipated foci of attention. This visual attention system was created to simulate "the neuronal architecture of the early primate visual system" (Itti et al. 1998, 1254). Saliency maps are created through algorithms that evaluate color, intensity,

orientation, and motion within a photograph. Saliency maps were originally created from a bottom-up perspective, and were subsequently modified by Antonio Torralba to take into account top-down processing (Torralba 2005). When studying visual perception, bottom-up and top-down processing cannot be easily isolated.

### 2.3. Saliency Mapping and Landscape Architecture

Lien Dupont et al. (2016) studied saliency maps in the context of landscape architecture. Landscape architects often conduct a visual impact assessment when proposing changes to a landscape. For example, a visual impact assessment is required for proposed changes along Route 1 in California, to minimize the visual impact on the scenic coastline. With accurate computer-generated saliency mapping, landscape architects could determine whether their proposed design would significantly impact the visual perception and attention to a given landscape. In this study, computer-generated saliency maps were compared to human focus maps – obtained by collecting eye tracking data as participants viewed images - to test the accuracy of predicting the human viewing pattern. Seventy-four landscape photographs were shown, ranging from rural to urban scenes, for ten seconds each. An eye tracking device recorded the results in the form of a focus map, which was then compared to the saliency map for each photograph. A relatively high correlation was found, demonstrating that saliency maps can be a reliable prediction of human observation patterns. However, the correlation between the saliency map and focus map was found to be greater in rural landscapes, showing that human viewing behavior can be more easily predicted in these settings, as opposed to urban landscapes. This suggests that the saliency map may not be as reliable for architectural views.

### 3.0. STUDY OF SELECTIVE ATTENTION AND THE BUILT ENVIRONMENT

In this pilot study of the visual perception of architectural spaces, we were interested in both the mode of representation (comparing photograph to drawing) and the audience (comparing Architecture students to Preschool students). Collecting and analyzing eye tracking data, we tested our preliminary hypotheses:

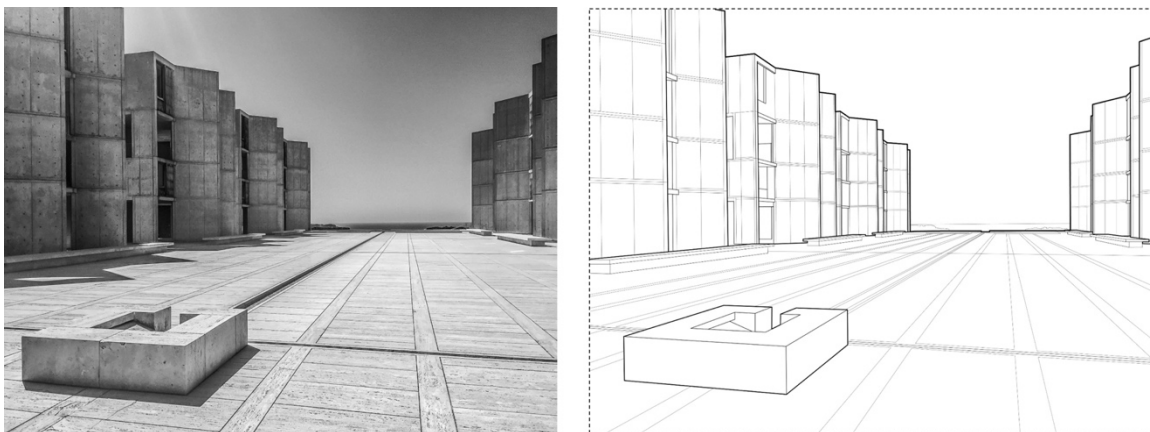
1. There will be differences between the salient features attracting attention in a photograph compared with a perspectival line drawing of the same space.
2. There will be differences in the salient features attracting the attention of Architecture students compared with Preschool students.
3. A saliency map will not consistently predict the areas of an image attracting attention.

### 3.1. Eye Tracking to Compare Modes of Architectural Representation

We used two different modes of representation – a photograph and a matching perspectival line drawing of the Salk Institute in La Jolla, CA, by the architect Louis Kahn (Fig. 2). In order to compare salient features, we set up Areas of Interest (AOIs), and collected eye movement data for each AOI. (In the Gazepoint eye tracking software, AOIs have to be orthogonal, so each AOI was made up of many rectangles to more closely match the perspectival lines.) The AOIs were determined by basic compositional elements of the image:

Sky / Ground / Visual Center / Horizon/Edge / Foreground Elements / Buildings

Measurements recorded and analyzed for each AOI were *Time to First View* (sec), *Time Viewed* (sec), and *Fixations* (n). The participants were not given any instructions other than to look at the image, in order to privilege bottom-up processing.

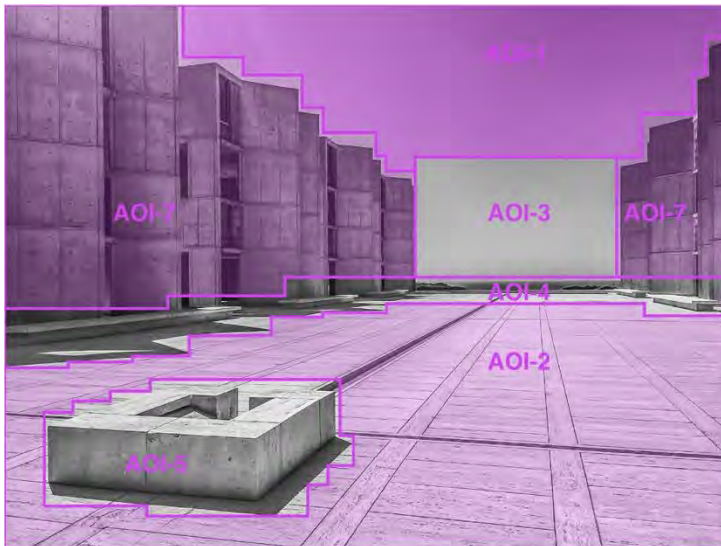


**Figure 2:** Study participants were shown either photographs or line drawings of architectural views. The analysis described in this paper looks at the Salk Institute pairing. Source: (Author 2019)

### 3.2. Results and Analysis

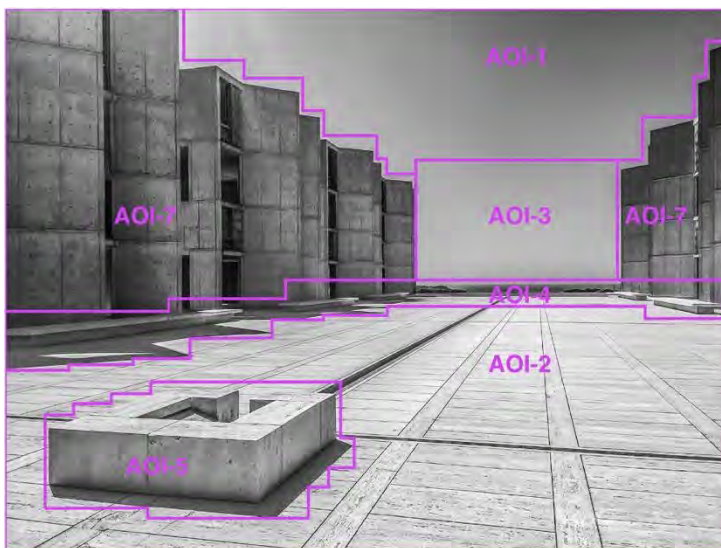
For the analysis, we compared the averages for *Time to First View*, *Time Viewed*, and *Fixations*, recognizing a P value of less than 0.05 as significant. (The highlighted areas of the following images paired with tables show statistically significant differences for one or more measurements in an Area of Interest.) Overall, we saw that Architecture students'

visual attention differed between the drawing and the photo, while the attention of the Preschool students did not. The results suggest that the trained eye (that of the Architecture student) will focus on the architecture in an image, but to a greater degree in a drawing. This view of the Salk Institute was chosen because it captures the powerful dialogue between solid and void, as well as the “façade to the sky” as Luis Barragán described the ground plane (Treib 2006). The eye movements of the Architecture students matched Louis Kahn’s intent for the Salk Institute – that the architecture frame the sky and horizon, drawing the eye towards the ocean beyond. This is an interesting result given that the participants were not there in person but were looking at a photo, in which the ocean is barely visible. For Architecture students viewing the photo vs. the drawing, the sky, even though it is empty, attracted the attention of Architecture students across all measurements when looking at the photo as compared with the drawing. Architecture students also spent more time looking at the ground in the photo but fixated on the building more in the drawing. (Fig. 3) For Preschool students viewing the photo vs. the drawing, there were no significant differences in any areas of the images. (Fig. 4)



Media	AOI	TtFV avg	TV avg	Fix avg
photo	AOI-1	7.6	0.12	1.05
drawing	AOI-1	4.74	0.35	3.29
p-value	AOI-1	0.039	0.036	0.017
photo	AOI-2	1.43	1.45	7.65
drawing	AOI-2	2.32	0.79	5.06
p-value	AOI-2	0.279	0.035	0.083
photo	AOI-3	3.07	1.41	5
drawing	AOI-3	3.23	1.22	4.88
p-value	AOI-3	0.985	0.545	0.956
photo	AOI-4	1.94	1.17	6.35
drawing	AOI-4	1.65	0.74	5.41
p-value	AOI-4	0.618	0.125	0.554
photo	AOI-5	2.6	1.23	5.25
drawing	AOI-5	1.55	1.34	5.12
p-value	AOI-5	0.184	0.816	0.939
photo	AOI-7	1.01	3.22	14.3
drawing	AOI-7	0.78	3.91	20.12
p-value	AOI-7	0.421	0.172	0.032

**Figure 3:** The highlighted areas of the photo and table show the significant differences when Architecture students viewed the photograph as compared with the drawing. Source: (Author 2020)



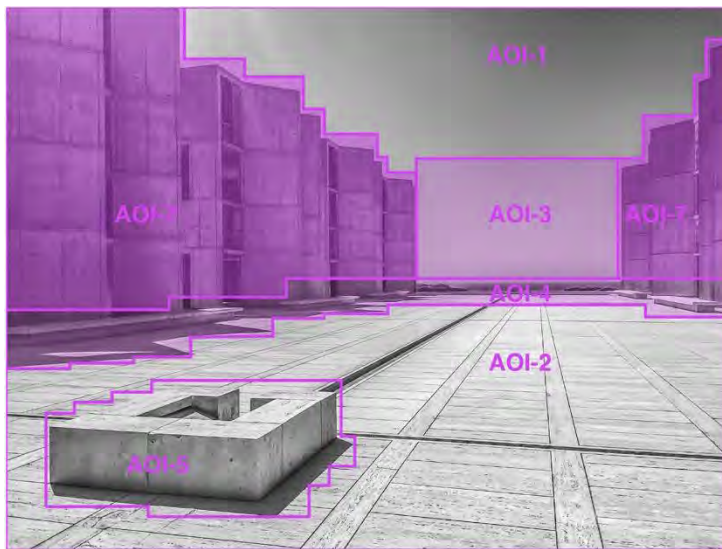
Media	AOI	TtFV avg	TV avg	Fix avg
photo	AOI-1	6.48	0.11	0.67
drawing	AOI-1	7.66	0.08	0.56
p-value	AOI-1	0.649	0.789	0.912
photo	AOI-2	3.31	1.11	5.11
drawing	AOI-2	6.17	0.67	3.67
p-value	AOI-2	0.267	0.499	0.603
photo	AOI-3	5.30	0.36	1.89
drawing	AOI-3	8.70	0.23	1.00
p-value	AOI-3	0.094	0.762	0.568
photo	AOI-4	5.06	0.49	3.22
drawing	AOI-4	7.10	0.15	2.11
p-value	AOI-4	0.417	0.181	0.581
photo	AOI-5	3.00	1.30	4.00
drawing	AOI-5	5.24	0.68	3.00
p-value	AOI-5	0.385	0.461	0.729
photo	AOI-7	3.51	1.21	5.11
drawing	AOI-7	5.49	1.18	3.78
p-value	AOI-7	0.469	0.931	0.767

**Figure 4:** The results show no significant differences when Preschool students viewed the photo as compared with the drawing. Source: (Author 2020)

When comparing how Architecture and Preschool students viewed the photo, Architecture students spent more time and had more fixations on the visual center compared to Preschoolers. Preschoolers took longer to focus on the buildings and spent less time looking at them. Architecture students had almost three times as many fixations on the

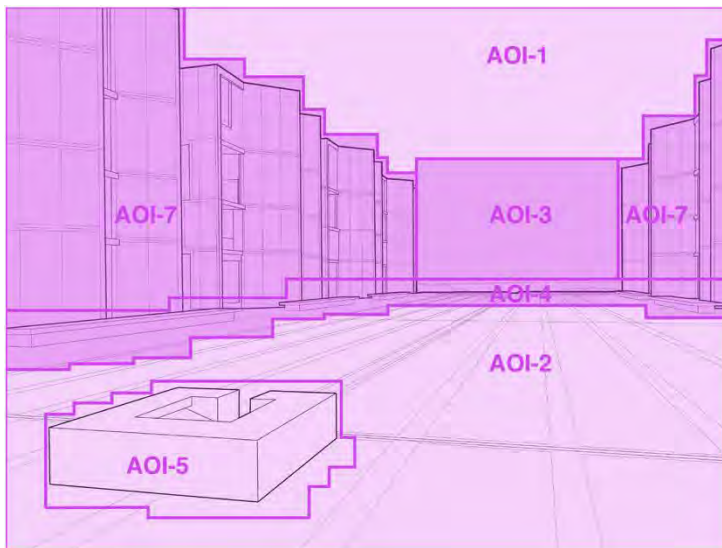


buildings. (Fig. 5) When comparing how Architecture and Preschool students viewed the drawing, there were significant differences for every AOI. Most notably, Architecture students looked at the visual center and the horizon and edge between building and ground much sooner, spent more time looking at these areas, and had about 4 times as many fixations. (Fig. 6)



Media	AOI	TtFV avg	TV avg	Fix avg
ARCH	AOI-1	7.60	0.12	1.05
PRE	AOI-1	6.48	0.11	0.67
p-value	AOI-1	0.465	0.881	0.599
ARCH	AOI-2	1.43	1.45	7.65
PRE	AOI-2	3.31	1.11	5.11
p-value	AOI-2	0.059	0.414	0.128
ARCH	AOI-3	3.07	1.41	5.00
PRE	AOI-3	5.30	0.36	1.89
p-value	AOI-3	0.124	0.013	0.031
ARCH	AOI-4	6.35	1.17	1.94
PRE	AOI-4	5.06	0.49	3.22
p-value	AOI-4	0.014	0.074	0.051
ARCH	AOI-5	2.60	1.23	5.25
PRE	AOI-5	3.00	1.30	4.00
p-value	AOI-5	0.733	0.896	0.420
ARCH	AOI-7	1.01	3.22	14.30
PRE	AOI-7	3.51	1.21	5.11
p-value	AOI-7	0.004	0.001	0.002

**Figure 5:** The highlighted areas of the photo and table show the significant differences when the photo was viewed by the Architecture students as compared with the Preschool students. Source: (Author 2020)

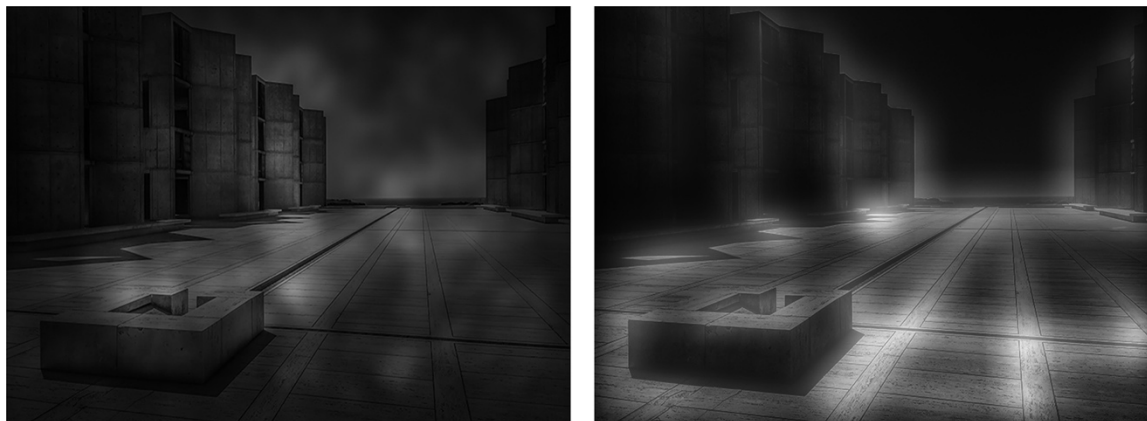


Media	AOI	TtFV avg	TV avg	Fix avg
ARCH	AOI-1	4.74	0.35	3.29
PRE	AOI-1	7.66	0.08	0.56
p-value	AOI-1	0.065	0.057	0.018
ARCH	AOI-2	2.32	0.79	5.06
PRE	AOI-2	6.17	0.67	3.67
p-value	AOI-2	0.012	0.752	0.425
ARCH	AOI-3	3.23	1.22	4.88
PRE	AOI-3	8.7	0.23	1.00
p-value	AOI-3	0.000	0.005	0.001
ARCH	AOI-4	1.65	0.74	5.41
PRE	AOI-4	7.1	0.15	2.11
p-value	AOI-4	0.000	0.013	0.016
ARCH	AOI-5	1.55	1.34	5.12
PRE	AOI-5	5.24	0.68	3.00
p-value	AOI-5	0.004	0.248	0.108
ARCH	AOI-7	0.78	3.91	20.12
PRE	AOI-7	5.49	1.18	3.78
p-value	AOI-7	0.000	0.005	0.000

**Figure 6:** The highlighted areas of the drawing and table show the significant differences when the drawing was viewed by the Architecture students as compared with the Preschool students. Source: (Author 2020)

We also investigated whether a computer-generated saliency map could predict the areas of a photo that would receive the most attention. We took the focus map video for Architecture students and collapsed the video frames into a single static image for comparison with the saliency map. At first glance we could see that the saliency map predicts the ground as attracting attention, while the focus map from the participants shows the horizon and sky to be of greater interest. We anticipated that a quantitative comparison would show the saliency map to differ from the focus map. (Fig. 7) We tested the accuracy of the computer-generated saliency map in predicting the salient features of an image by importing the images into MATLAB. In MATLAB, the images were broken down into matrices and analyzed by comparing pixel intensities, and then we calculated a Pearson correlation coefficient. The correlation coefficient is a measure of the linear correlation between two variables X and Y – in this case, between the saliency map and the focus map. Using Dupont et al.'s (2016) method for comparing a saliency map to a focus map, we arrived at a correlation coefficient of 0.3564, which indicates that while the two maps are somewhat similar, there is a weak positive correlation

between the two. From this, we can gather that the saliency map is only mildly reliable at predicting areas of interest, and cannot replace a focus map. This confirms Dupont et al.'s conclusion that the saliency map was more accurate for predicting attention in a rural landscape than an urban one. The results suggest that the visuospatial literacy of the participant – the ability for the participant to perceive three-dimensional space in a two-dimensional image, rather than only two-dimensional characteristics – plays a role in what aspects of the photo are attended to. The saliency map might be improved through Artificial Intelligence: with enough human eye tracking data to support machine learning, it could more closely approximate a human viewing pattern.



**Figure 7:** The image on the left is a focus map, showing the areas of the photograph most attended to by the participants. The image on the right is a saliency map, an algorithmically-derived map anticipating the areas that participants would attend to. Source: (Author 2020)

## CONCLUSION

Through this experiment, we found that both the mode of representation and the audience affect how architectural spaces are visually perceived, even without a task. While visual perception is individual and idiosyncratic, the empirical research does bear out commonalities amongst test subjects. A study comparing less diverse participants – like architecture students and students in other majors – would be useful. A valuable next step would be to expand both the objective measurement of physiological responses and the collection of phenomenological responses to embodied experience and graphic representations. There are additional types of physiological data we could collect - heart rate, galvanic skin response, EEG - and many modes of representation to investigate, like renderings and augmented or virtual reality. Additionally, we could collect phenomenological data from the participants, asking them what they notice in an image. A unique challenge is the measurement of physiological responses in an embodied experience. Photography, perhaps, more closely approximates the real space, but eliminates peripheral visual data and other sensory information and does not address the role of time in our experience of architecture. Since a static photograph is not a sufficient analog for the embodied experience, it would be valuable to collect physiological data from participants as they inhabit a work of architecture. Further research can employ both objective and subjective data in seeking to anticipate how people will respond to works of architecture. If we could anticipate how spaces will affect the occupant's phenomenological experience by how they respond to images of it, we could design a better built environment.

## ACKNOWLEDGEMENTS

This study was completed in collaboration and consultation with Cal Poly students Wood Cheng and Melina van Oers, and faculty Dr. Jeffrey Sklar, Statistics, and Dr. Laura Cacciamani, Psychology.

## REFERENCES

- Arnheim, R. 1956. *Art and Visual Perception: A Psychology of the Creative Eye*. London: Faber and Faber.
- Buswell, G. 1935. *How People Look at Pictures: A study of the psychology of perception in art*. Chicago: University of Chicago Press.
- Carlson, L. 2010. Top-Down and Bottom-Up Processing. In *Encyclopedia of Perception*, ed. Bruce Goldstein, 1012-1014. Thousand Oaks, CA: SAGE Publications. doi: 10.4135/9781412972000.n324.
- Dupont, L. et al. 2016. Comparing saliency maps and eye-tracking focus maps: The potential use in visual impact assessment based on landscape photographs. *Landscape and Urban Planning* 148: 17–26.
- Hershenson, M. 1999. *Visual Space Perception: A Primer*. Cambridge, Massachusetts: MIT Press.
- Holmqvist, K. et al. 2015. *Eye Tracking: A comprehensive guide to methods and measures*. New York: Oxford University Press.
- Itti, L. et al. 1998. A Model of Saliency-based Visual Attention for Rapid Scene Analysis. *IEEE Transactions on Pattern Analysis and Machine Intelligence* 20(11): 1254-1259.
- Oliva, A. 2005. Gist of the Scene. In *Neurobiology of Attention*, ed. Laurent Itti et al., 251-256. Amsterdam; Boston: Elsevier Academic Press.
- Oliva, A. 2010. Visual Scene Perception. In *Encyclopedia of Perception*, ed. Bruce Goldstein, 1111-1116. Thousand Oaks, CA: SAGE Publications.
- Pihko, E. et al. 2011. Experiencing Art: The Influence of Expertise and Painting Abstraction Level. *Frontiers in Human Neuroscience*, 5: 94.
- Shields, J. et al. 2016. Evaluating the veridicality of two-dimensional representations of three-dimensional architectural space through physiological response. In *Architectural Research Addressing Societal Challenges*, eds, M. Couceiro da Costa et al: 1001-1014. London: Taylor & Francis Group.
- Treib, M. 2006. To End a Continent: The Courtyard of the Salk Institute. *Journal of the Society of Architectural Historians*, 65(3), 402-427. doi:10.2307/25068295
- Torralba, A. 2005. Contextual Influences on Saliency. In *Neurobiology of Attention*, ed. Laurent Itti et al., 586-592. Amsterdam; Boston: Elsevier Academic Press.
- Torralba, A. et al. 2006. Contextual Guidance of Eye Movements and Attention in Real-World Scenes: The Role of Global Features in Object Search. *Psychological Review*, 113 (4): 766 –786.
- Weber, R. et al. 2002. The Impact of Formal Properties on Eye Movement During the Perception of Architecture. *Journal of Architectural Planning and Research*, 19 (1):57-68.
- Weber, R. 1995. *On the Aesthetics of Architecture: A Psychological Approach to the Structure and the Order of Perceived Architectural Space*. Aldershot: Avebury.
- Yarbus, A. and Haigh, B. 1973. *Eye Movements and Vision*. New York: Plenum Press.

# Cost in Space: A Value-Based Approach to Architectural Pathfinding

Jacklynn Niemiec<sup>1</sup>, Steven Lilley<sup>1</sup>

<sup>1</sup>Drexel University, Philadelphia, PA

**ABSTRACT:** Spatial costs that may affect pathfinding within an interior environment include variables and stimuli such as destination, ease, distance, light, sound, or even a natural tendency to move to the right. (Boettger 2014) These elements, and others, along with formal cues, can contribute to the navigation of an indoor environment. Several tools currently exist to simulate the path of travel for egress—using plans or occupancy loads in a building. These tools often generate the shortest path of travel. Methods for altering or influencing the shortest path are less prevalent, yet their potential is important to consider. This paper presents an approach for associating architectural value within a building model and using it to influence pathfinding. The method presented uses A\* pathfinding as a baseline grid and recalculates travel paths per the local or global influence of architectural value. (Hart, Nilsson, and Raphael 1968) This project's results are explored in a case study, and speculation of its application within the design process and everyday use of space is considered.

**KEYWORDS:** wayfinding, indoor navigation, pathfinding, bim

## INTRODUCTION

Form influences action, creating environments with potential for decision-making, interaction, and memory. Actionable space provides the inhabitant opportunity and agency in its use. (Plummer 2016) Such influential qualities include architectural form, site, or attributes such as light or material. Sensory information could significantly impact metric information. "Two rooms of the same size will feel altogether different if one has natural light and the other is lit artificially ... space with a lot of windows will almost always pull you toward the view..." (Goldberger 2009) This confluence of form and experience creates a series of episodic memories, defining one's experience through visual and physical means. (Tversky 2020) These observations are of consequence to how we move through space.

The term *circulation* was borrowed from physiology and the circulatory system's mechanics to describe areas for movement within buildings. The word *distribution* preceded circulation, favoring functionality, the rigidity of axes, and discrete rooms. (Forty 2004) Corridors and stairs are typical examples, though the boundaries of circulation spaces can be implied by movement and defined in less material ways. (Hertzberger 2000) Likewise, as described by (Lynch 1960, 47), *paths* represent "channels along which the observer customarily, occasionally, or potentially moves." Architecture's relationship between form and experience has evolved over time. Buildings governed by strict geometry led with the eye, while modern and contemporary architects tend to emphasize physical experience, leading instead with the body. (McCarter 2016)

Modernism gave rise to this theme in Le Corbusier's promenade architecturale, a sequence of spaces designed to lead the inhabitant through the architecture. Though nothing was left to chance; there was "nothing arbitrary about the way the sequence unfolded." (Samuel 2012, 9) Later, architects tested ideas of polyvalence, chance, and participation by avoiding design narratives that limited agency. (Hertzberger 1998; Plummer 2016; De Carlo 1980) Contemporary architecture's relationship with circulation has also evolved. Some relied heavily on technology to generate forms, while others wrestle now with a post-digital agenda to regain control of design at the scale of human experience. From the abstract world of fields and flows to simulate forces through space to recent work by Hilary Sample and Michael Meredith of M.O.S. Architects who suggest the collapsing of circulation space into a form all its own. (Chicago Architecture Biennial 2015) The role of circulation and movement in architecture has always been influential. However, the success of a building to architects and the success of a building to its users may not always align. As experienced in OMA's Seattle Public Library, where wayfinding and circulation play a central role in this division. (Conroy Dalton, Hölscher, and Hölscher 2016)

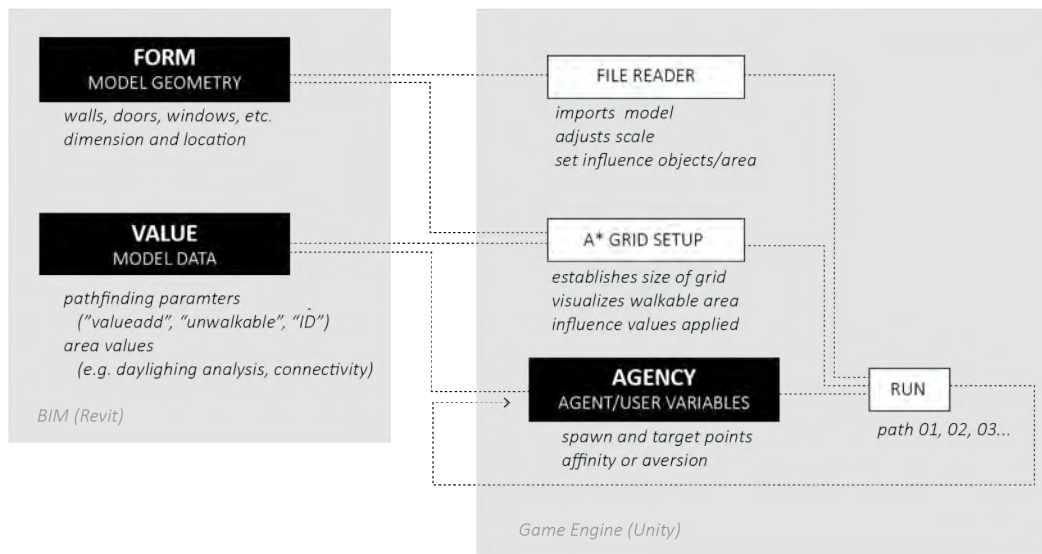
External and internal factors guide spatial decision-making. Internal factors refer to the cognitive processes at play in our spatial decisions, often reliant on individual experience, preference, and memory. (Bond 2020) External forces are a result of built form, whether in the streets of a city or corridors of a building. The built environment can support or suppress the wayfinding experience through its design. (Passini 1992) Creating a tool that considers both may help inform how we inhabit space and establish a sense of place. As "place...requires both regularity and variety, order and

change." (Buttimer and Seamon 2015, 163)

This paper presents a method for pathing in response to both space and user. Section one outlines the basic structure of the workflow setup and pathing system. Section two summarizes the modified A\* pathfinding algorithm and method used for applying architectural value to the traditional pathing model. Sections three and four will present a case study and outcomes. Conclusions for future use are drawn at the end of the paper.

## 1.0. FORM, VALUE, AND AGENCY

Existing tools for evaluating indoor pathing favor efficiency over experience. Efficiency has long governed the routing from point A to point B, and for a good reason. Egress and exit-route pathing are critical for life-safety, and tools for shortest-path routing in buildings are becoming more accessible to architects within modeling software. (Yori 2020) Though some recent design-centered approaches have emerged. These models use a generative process to reveal pathing options with corresponding spatial analysis. (Goldstein et al. 2020) Instead, the method presented here modifies the shortest-path model by applying influence in the form of architectural value and user agency. (Fig. 1)



**Figure 1:** Model workflow diagram

Three elements contribute to the architectural pathing approach presented: *form*, *value*, and *agency*. The first component, *form*, relates to the model geometry; walls, floors, doors, windows, and other physical elements in space. In this project, the model was created in Autodesk Revit and exported as a .fbx file for compatibility with the gaming engine Unity. The model objects are essential for creating an accurately scaled map. *Value* describes the data input or mined from the building information model and applied as architectural value.

Architectural values are applied in two forms; *area* and *component*. Area organization applies a unique value to every node in the grid; examples of this are daylighting studies or organizational analyses such as connectivity. (Hillier et al. 1976) While component values radiate and apply cost from individual building elements such as windows, doors, or even specific materials in a building model. Area analyses, such as daylighting studies, can also be applied across the entire node grid.

The third element, *agency*, refers to the user and their relative affinity or aversion to a particular value system. For instance, someone may prefer to move through quieter areas, stop in spaces with views, or be adjacent to a specific use. This last and most influential element represents the myriad users a place may have and works in tandem with value to calculate pathing options.

## 2.0. PATHFINDING

Early computational pathfinding solutions sought efficiency through "minimum cost" pathing. (Rabin 2015; Hart, Nilsson, and Raphael 1968) A\* is the generic search algorithm introduced by Hart, Nilsson, and Raphael still used as the basis of many pathfinding models today. The algorithm uses neighboring grid squares to calculate route cost incrementally. "When a location is explored, the algorithm is finished if that location is the goal; otherwise, it makes a note of all that location's neighbors for further exploration." (Cui and Shi 2010) A\* is used as the basis for pathfinding for this project. Its cost-based system made it possible to include architectural value with pathing costs to affect the existing node grid. The node grid establishes and discretizes the walkable area. A raycasting process uses the architectural model's



boundaries to determine the coverage area and resolution. Each node created contains positional data and a walkability parameter. Each node also references a (*G*) and (*H*) cost. These costs are associated with the distance from the start point and distance from the endpoint, respectively. A value of 10 relates to orthogonal movement, while 14 refers to diagonal moves. The *F* Cost of a node is the sum of the *G* and *H* values. A\* recalculates the *F* cost after each move, continuously searching neighboring nodes to ultimately generate the least expensive path.

The method presented here introduces three new variables to affect the standard A\* shortest path. Architectural value (*b*) is the value associated with a particular architectural element or area. This value is normalized within a range of 0-100. The added cost (*p*) refers to agency and describes the affinity or aversion toward a particular architectural value. The modified A\* system responds to both architectural value and affinity, making the resulting path contingent on spatial qualities and individual preference. (Fig. 2) The shortest path option shown between the start and end would be up and left two diagonal nodes. However, when the neighboring node at the left is assigned a higher architectural value with an assumed affinity  $-p$  for that value, the path is re-routed.

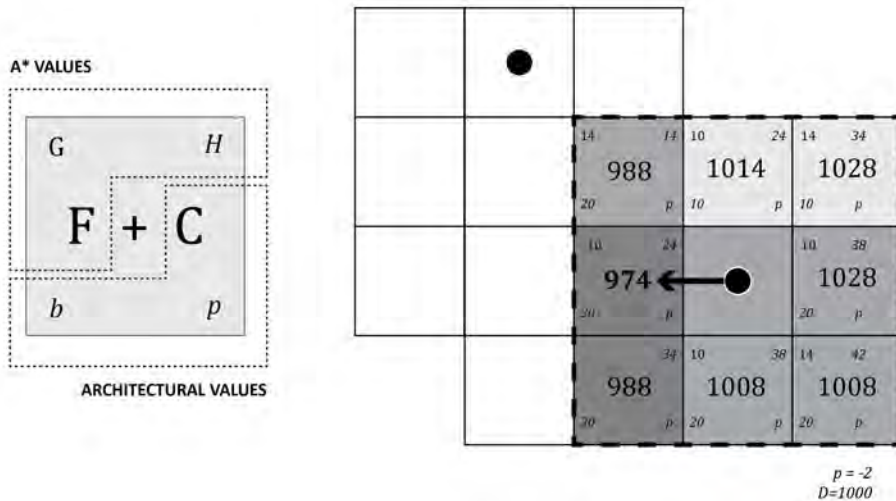


Figure 2: Modified A\* pathing, an example of node costs

Agency, or the "cost per architectural value," (*p*), establishes a variable rate for each node based on an agent's affinity, attraction or aversion, for the defined elements (light, material, etc.) and is used to calculate cost based on the architectural value of that node.

$$p = m * a + p_{max}, \text{ where:}$$

$$m = \frac{p_{min} - p_{max}}{a_{max}}$$

The A\* pathing system can provide undesirable results when nodes achieve a total cost equal to or below zero. To avoid this, when applying architectural cost on top of the original A\* pathing costs, a default cost (*D*) is used; this will vary per the overall dimensions and node resolution of a space. A positive total cost is met by constraining the total architectural cost (*C*) to greater than or equal to 0. Both *b*, the architectural value, and *p*, the architectural cost per value, must be restricted to meet this constraint. We determined that the greatest possible architectural value of the system,  $b_{max}$ , with the least possible value for *p*,  $p_{min}$ , should generate this boundary condition of the architectural cost being equal to 0, which leads to:  $C = b_{max} * p_{min} + D = 0$

This determines  $p_{min}$  based on designer input parameters *D* and  $b_{max}$  and is used to define  $p_{max}$  as the opposite value. We wanted the agent affinity to determine how architectural value would impact the resulting architectural cost, so *p* is directly proportional to affinity, *a*. Because *a* generates *p* and *p* must be constrained, *a* must also be constrained. Higher affinity relates to how much an agent is drawn to a particular architectural influence. As a result, a greater affinity should result in a lower, or negative, *p* value, which makes  $p_{min}$  a result of the greatest possible affinity,  $a_{max}$ . The determined value of *p* is used to calculate the total architectural cost (*C*) for each node. The interdependency of (*b*) and (*p*) supports the primary thesis of generating pathing options while considering individual agency and spatial experience. The total architectural cost (*C*) is added to each node's *F* Cost, resulting in the proposed value-based pathing.

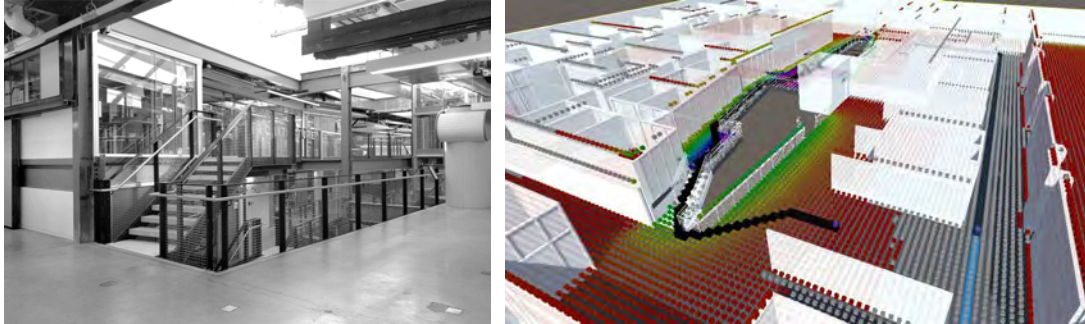
$$C = b * p + D$$

Depending on magnitude and density, architectural value and user affinity can ultimately outweigh the shortest path option. The case study suggests spatial relationships increase or decrease a modified path's likelihood.



### 3.0. CASE STUDY

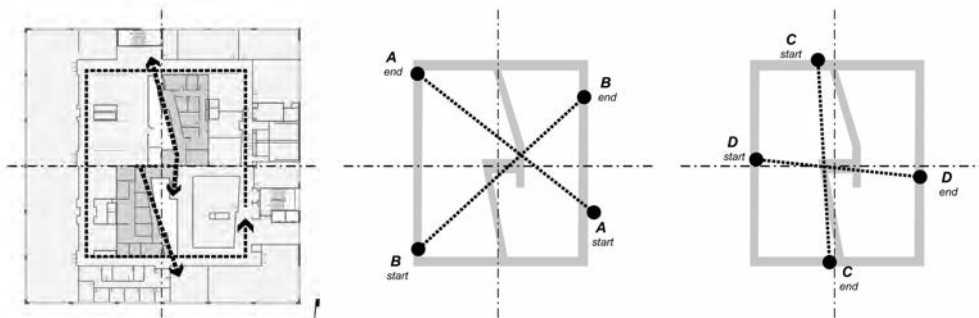
The URBN Center at Drexel University is home to the Antoinette Westphal College of Media Arts & Design. The building, initially designed by Venturi Scott Brown, was reconceived by Meyer, Scherer & Rockcastle, Ltd. (M.S.R.) in 2012. The redesigned interior creates visual access and architectural dynamism within a "decorated shed." (Venturi, Scott Brown, and Izenour 1998) Many of the building's new teaching spaces double as circulation, creating a unique overlap in the building's use and activity.



**Figure 3:** View southeast (left) corresponding view of pathing with daylighting value visualized (right)

Classroom and office spaces are along the exterior walls, while the atrium provides natural light to centrally located rooms. The primary circulation path rings the main floors, while another runs through the center connecting half-levels while also providing an alternate means of traversing the space. The half-level change in elevation, however small, is an essential variable for testing the system in a multi-level environment. The raycasting process utilized allows for a three-dimensional, or voxel, system for pathing. (Fig. 3) The building's four-square logic guided the selection of four start and endpoints in the plan, yielding four pathsets. Each pathset (*A*, *B*, *C*, *D*) has a start (spawn) and end (target). Pathsets *A* and *B* test diagonal routes across the floor plan while *C* and *D* examine those running orthogonal to the building grid. (Fig. 4)

Daylighting analysis serves as the area-based influence in the study. Daylight factor values were generated, normalized, and assigned to each node in the model. The floor area adjacent to the atrium being most impacted. Paths significantly influenced by daylight values may re-route through the center of the plan. A higher architectural value of daylighting in that area will lower the route's total cost but will likely increase that route's total distance.



**Figure 4:** Plan diagrams and pathset organization

The component-based influence applied relates to presentation display walls adjacent to the design studios on the building's west side. The display walls assigned with this added value only influence their surrounding nodes, radiating value from their center at a given distance. The attraction or aversion to either of these architectural values also factors into the path's total cost. (Fig. 5)

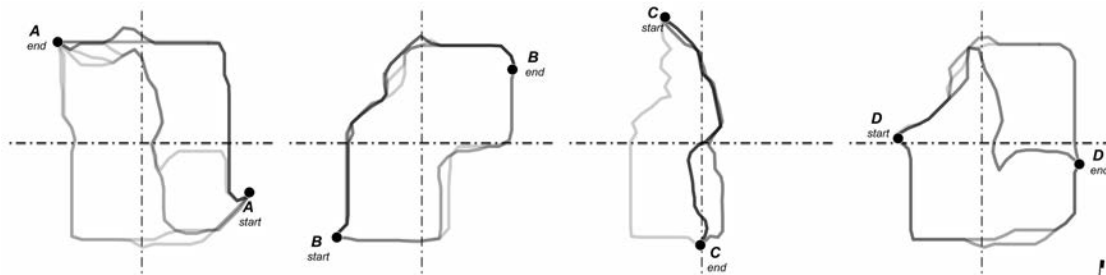
The three standard affinity values, 0, 50, and 100 were applied for daylighting and display. A zero value represents aversion toward a particular architectural influence, 50 equals neutrality, and an attraction toward that influence 100—three affinity values for each established nine permutations per set. The total architectural cost and length, in feet, of each path permutation was recorded. Length is the metric for comparison and analysis instead of the total cost, which uses a variable rate. Each pathset contains nine path length elements; for example,  $D = \{ 227.7', 220.8', 235.4', 216.7', 212.4', 235.4', 216.7', 212.4', 236.8' \}$



**Figure 5:** View southeast (left) corresponding view of pathing with daylighting value visualized (right)  
The system can apply multiple architectural influences at runtime and be adjusted to test a range of corresponding affinities. However, the overlay of more than two was not tested and would likely defuse the impact of architectural value. Adjusting for user affinity and prescribed spatial conditions distinguishes this method from others. Calibrating the affinity and value of architectural elements could significantly impact the resulting routes. For instance, a window with a view towards a park may justify more influence than another window element. Establishing a hierarchy of influence types and values for different building uses (e.g., education, healthcare, etc.) would better align the system to its use and inhabitants.

#### 4.0. RESULTS

Of the nine permutations, the number of unique routes will vary, and the impact of architectural value is dependent on the organization of each start and endpoint. (Fig. 6) Pathset A starts at the southeast corner and runs diagonally toward the northwest corner, providing the broadest range of route options. Here, the shortest path does not align with either architectural influence. When the daylighting and display affinities are applied, the routes are modified from the shortest path to follow their respective architectural influence, daylighting or display, closely. Pathset B traverses the plan from the opposite corners, starting in the southwest corner toward the northeast. However, when moving in this direction, the mezzanine stair is not readily accessible. The shortest path naturally runs along the display walls, making it the preferred route.



**Figure 6:** Routes generated in pathsets A, B, C, and D

The remaining two pathsets, C and D, are parallel to the building grid. Pathset C follows the atrium's length, starting at the north edge and ending at the south. As a result, this pathset naturally uses the mezzanine route as its shortest path, reducing variation. Pathset D cannot cross the building directly and generated routes with longer distances as a result. Each set's standard deviation establishes how close or spread out the path lengths are, suggesting greater or fewer route options produced in the model. (Table 1) If the shortest route was already closely aligned with an architectural value, such as daylighting at the atrium space, there are fewer departures from that primary route.

**Table 1:** Pathset Analysis

Pathset	Organization	Unique Routes	Mean Length ( $\mu$ )	Standard Deviation ( $\sigma$ )
A	Diagonal	4	239.9	16.7
B	Diagonal	2	223.1	6.7
C	Orthogonal	3	182.3	11.2
D	Orthogonal	3	223.8	10.1

The results of this initial study suggest that a value-based approach to architectural pathfinding is possible. Knowing the underlying A\* system is essential, making the node grid resolution, default architectural cost, and applied values

critical variables to control. The building used here was unique in its layout, enabling variety in the pathing outcomes in a limited footprint. While this method may not apply to all spaces, we have speculated on its future use based on these results.

## CONCLUSION

As a tool, this system is flexible, and we imagine it could be used in modified outdoor settings. Though of immediate interest is testing how this system can flex for different scales and specific programmatic uses. Similarly, an evidence-based approach to *affinity* would be necessary for objective pathfinding results. The process revealed several other takeaways:

- Architectural value is more effective when applied as an area influence. The gradation of values is more effective for pathing than the binary effect of component-based influence.
- The start and end of a pathset should be carefully selected. Pathsets with limited options for routing should be vetted early in the process.
- Overlaps or alignments with the shortest-path route and an architectural value make it difficult for the system to provide alternate pathing.
- Refinement of workflow between the modeling software and game engine would make the system more accessible and efficient.

Lastly, using the system as a tool for observation rather than simulation is considered for future study. Evaluating the user's actual movement relative to organization and form could support a more thorough reflection of architecture's role in everyday life and better inform future design decisions. Studying why people choose certain paths in existing spaces can better inform future places, as "short-sightedness of the objectives and the lack of interest in the question of using the product makes it impossible to establish any criterion that allows a judicious comparison between proposed and actual accomplishment." (De Carlo 1980)

## ACKNOWLEDGEMENTS

This project was made possible through funding from Drexel University and the Antionette Westphal College of Media Arts & Design at Drexel University.

## REFERENCES

- Bond, Michael Shaw. 2020. *Wayfinding : The Art and Science of How We Find and Lose Our Way*.  
Buttimer, Anne, and David Seamon. 2015. *The Human Experience of Space and Place*. London: Routledge.  
Chicago Architecture Biennial. 2015. *State of the Art of Architecture Chicago Architecture Biennial*. Place of publication not identified: Lars Muller Publishers.  
Conroy Dalton, Ruth, Christoph Hölscher, and Christoph Hölscher. 2016. *Take One Building: Interdisciplinary Research Perspectives of the Seattle Central Library*. London, UNITED KINGDOM: Routledge. <http://ebookcentral.proquest.com/lib/drexel-ebooks/detail.action?docID=4748534>.  
Cui, Xiao, and Hao Shi. 2010. "A\*-Based Pathfinding in Modern Computer Games." *International Journal of Computer Science and Network Security* 11 (November).  
De Carlo, Giancarlo. 1980. "An Architecture of Participation." *Perspecta* 17: 74–79.  
Forty, Adrian. 2004. *Words and Buildings: A Vocabulary of Modern Architecture*. 1st pbk. ed. New York: Thames & Hudson.  
Goldberger, Paul, ed. 2009. "Architecture as Space." In *Why Architecture Matters*, 109–38. Yale University Press.  
Goldstein, Rhys, Simon Breslav, Kean Walmsley, and Azam Khan. 2020. "SpaceAnalysis: A Tool for Pathfinding, Visibility, and Acoustics Analyses in Generative Design Workflows," 8.  
Hart, Peter E., Nils J. Nilsson, and Bertram Raphael. 1968. "A Formal Basis for the Heuristic Determination of Minimum Cost Paths." *IEEE Transactions on Systems Science and Cybernetics* 4 (2): 100–107.  
Hertzberger, Herman. 1998. *Lessons for Students in Architecture*. Fourth revised edition. Rotterdam: 010 Publishers.  
Hertzberger, Herman. 2000. *Space and the Architect: Lessons in Architecture 2*. Rotterdam: 010 Publishers.  
Hillier, Bill, Adrian Leaman, Paul Stansall, and Michael Bedford. 1976. "Space Syntax." *Environment and Planning B: Planning and Design* 3 (2): 147–85.  
Lynch, Kevin. 1960. *The Image of the City*. Publications of the Joint Center for Urban Studies. Cambridge [Mass.]: M.I.T. Press.  
McCarter, Robert. 2016. *The Space within: Interior Experience as the Origin of Architecture*. London: Reaktion Books.  
Passini, Romedi. 1992. *Wayfinding in Architecture*. Updated paperback edition. New York: Van Nostrand Reinhold.  
Plummer, Henry. 2016. *The Experience of Architecture*. London: Thames & Hudson Ltd.  
Rabin, Steven. 2015. *Game AI Pro 2: Collected Wisdom of Game AI Professionals*. A K Peters/CRC Press.  
Samuel, Flora. 2012. *Le Corbusier and the Architectural Promenade*. Basel: Walter de Gruyter GmbH.  
Tversky, Barbara. 2020. "Cognitive Maps, Cognitive Collages, and Spatial Mental Models." In *Mental Mapping. The Science of Orientation. New Approaches to Location*, 11–22. Passau: Schenk Verlag.  
Withagen, Rob, and Simone R. Caljouw. 2017. "Aldo van Eyck's Playgrounds: Aesthetics, Affordances, and Creativity." *Frontiers in Psychology* 8. <https://doi.org/10.3389/fpsyg.2017.01130>.  
Yori, Robert. 2020. *Mastering Autodesk Revit 2020*. 1st edition. Indianapolis, Indiana: Sybex.

# Vision Machines of Territorial Control

Ersala Kripa<sup>1</sup>

<sup>1</sup>Texas Tech University, El Paso, TX

**ABSTRACT:** The US-Mexico border in the Chihuahuan and Sonoran Deserts is inundated by dust storms, increasing in intensity and scale due to climate change. While large-scale dust events are monitored by formal networks of stationary sensors, smaller and more spontaneous dust formation evade monitoring. Dust devils—small swirling of dust due to localized hot and cold air mixing—erupt quickly and can cause health and safety hazards at the scale of the human body. Vast areas of the desert, especially near the border, are not densely populated, and spontaneous effects of small dust events impact mostly border crossers. As desertification continues to affect the geology of the region and force more humans into climate migration, tools for better visualizing and predicting small dust events gain urgent importance.

**KEYWORDS:** border, binational, surveillance, dust, geopolitics

## INTRODUCTION

### **Small scale dust events and their effects on migrating bodies**

The US-Mexico border in the Chihuahua and Sonoran Deserts is inundated by dust storms, increasing in intensity and scale due to climate change. As desertification continues to affect the geology of the region, and prolonged droughts create more dry beds in former water bodies, known as playas, the exposed earth's surface is covered in fine sand and dust. This dust is mostly composed of mineral particulate matter and during the windy season it is suspended by winds, forming large-scale dust storms. Despite increased desertification, the region has continued to urbanize since Mexico's establishment of duty-free zones on the border in 1965 in an effort to industrialize its northern areas, transforming agricultural land into industrialized landscapes. This fundamental shift of the territory altered its surface, amplifying the already dry conditions of its geology. The rampant production of light industry, aided by the NAFTA, added pollution to the region (Kotvis), affecting the contents of particulate matter of dust storms in border cities.

Large-scale dust events are well-monitored and observable with detail from NOAA and NASA's satellites, the GOES-16 and 17 (Geostationary Operational Environmental Satellites). The GOES-16 provides images at one tenth of a square mile resolution. Given the size of dust storms, they can be tracked from miles above the earth's surface and their path and duration can be somewhat predicted (NOAA). To the naked eye, a dust storm announces its presence from distances which allows for preparedness and protection, albeit quickly moving. NOAA studies show dust storms are increasing in frequency, currently at 50 per year in the Southwest region.

Small-scale localized dust events, on the other hand, happen more frequently, without predictable seasonality, and are not detectable by satellite imagery. Dust devils—small swirling of dust due to localized hot and cold air mixing—erupt quickly and can cause health and safety hazards at the scale of the human body. Dust devils occur when the surface temperature of the ground is rapidly heated by the afternoon sun, and energy from the heat is absorbed in the air creating an energy deficit, which, when coupled with light wind, forms swirls of air that drag sand and dust in their path (Reiss). The heat differential must be greater than the adiabatic gradient, which is about 1.6 degree Fahrenheit per 300 feet. Vast areas of the desert, especially near the border experience small dust events often. The main danger of a small dust event is its undetectability by satellite due to its small footprint and short life of an average of five minutes. Its mercurial nature renders it more likely to be a threat to pedestrians, rather than buildings or vehicles. In the border context, this impact is mostly felt by border crossers who walk the desert away from ports of entry. Although undocumented border crossings have decreased in the Arizona and Texas borders since the Migrant Protection Protocol was established in January 2019—also known as 'Remain in Mexico'—400,651 migrants crossed the border undocumented in 2020 (Gonzalez-Barrera), presumably away from ports of entry (Fischer). Of interest to this project is the change in the season in which migration is occurring. Recent migration trends have shifted peak crossings from the month of March to September, which can record temperatures as high as 104F vs 90F in March. In 2020, the El Paso Border Patrol sector alone apprehended 54,396 migrants crossing the border on foot (HRW). Since the expansion of the border fence, more migrants cross in the desert, which increases their chances of encountering dust events and other extreme environmental hazards. Finding tools that can easily map dust devils, able to analyze and assess their magnitude, may provide useful information that can eventually be used at a widely distributed scale. While the current stage of the project required equipment and software that is not readily available to border crossers, the endeavor hopes to provide a starting point of further research and dissemination. Since migrants who cross the border are not

likely to have access to mobile telephones and data, the future phases of the project hope to use the knowledge gained by the current workflow to publish a dust almanac, which would provide seasonal estimates to be used as predictive guides.

### **Tracing Invisibility**

In this context, tools for better visualizing and assessing small dust events gain urgent importance. Current dust event monitoring relies on stationary cameras that stitch together time-lapse photography and capture visual qualities of dust events from a long-distance aerial angle but lack the ability to capture truly spatial (3D) and time-based (4D) information at a fine scale (Kripa). Camera networks are often managed by governmental or environmental agencies, which rely on limited deployments at statistically-probable sites. Since many local dust events evade monitoring, and happen unexpectedly and unpredictably, mobile measuring techniques are necessary.

## **1.0 OBJECTIVES**

The project endeavors to develop a method of visually capturing and explicitly modelling small dust events in order to build knowledge of dust optics. In capturing meteorological information on the ground, and by developing tools appropriate for individual app use, the image of the binational desert is rendered more visible and tangible at a crowd-sourcing level. While the security apparatus of the Department of Homeland Security (DHS) and US Customs and Border Protection (USCBP), surveils the territory to detect human movement, effectively gaining a top-down complete image that controls migration, the bottom-up nature of the dust scanning technique allows for an agile and distributed alternative image that is informationally useful to the surveilled, to geologists, and environmentalists with an interest in the decentralization of monitoring. Currently, there are approximately ninety personal weather stations and hyperlocal commercial monitoring stations measuring wind, temperature, and particulate matter 2.5 and 10 (PM2.5, PM10) in the Chihuahuahua and Sonora Deserts on or near the border (Wunderground). Mining the data collected from the already robust citizen-science network, may allow for temperature differential calculations, which, when combined with wind data, and averaged with seasonal dust event probabilities, can help to establish predictions both temporally and geographically.

The desert climate of the US-Mexico border is home to a top-down sophisticated surveillance network capable of detecting the movement of humans and animals through infrared imaging which 'sees' through dust. During the prolonged dry season, between May and September, all movement triggers dust plumes, which reveal border-crossers' location to CBP agents (Kripa, Mueller). Small dust events are thus not only damaging to border crossers' health, they also render them vulnerable to legal authorities. Vision machines have controlled territories and bodies for centuries, and the desire to reverse the direction of the panopticon has produced equally effective countersurveillance techniques, such as reflective blankets that block infrared signatures, camouflage, digital scramblers, etc. The dust scanning method adds to the arsenal of self-defense technologies by developing tools that can offer a vision-based understanding of dust suspension behavior which may help to provide cover or alert against exposure.

## **2.0 METHODOLOGY**

The project explores workflows that can translate the morphology of a small-scale dust formation into a digitally constructed geometry which can offer clues about the physical properties of the dust event.

### **2.1 360D Horizontal Scanning**

The project uses a simulated dust event within an environmentally controlled indoor environment in order to isolate inputs in the design of a workflow. The workflow captures volumetric data from the indoor dust event and reconstructs it in digital space as a set of explicit surfaces. In order to isolate desired outcomes, and due to lack of a temperature-controlled infrastructural setting, the simulation does not rely on creating temperature differentials to stimulate the small dust event.

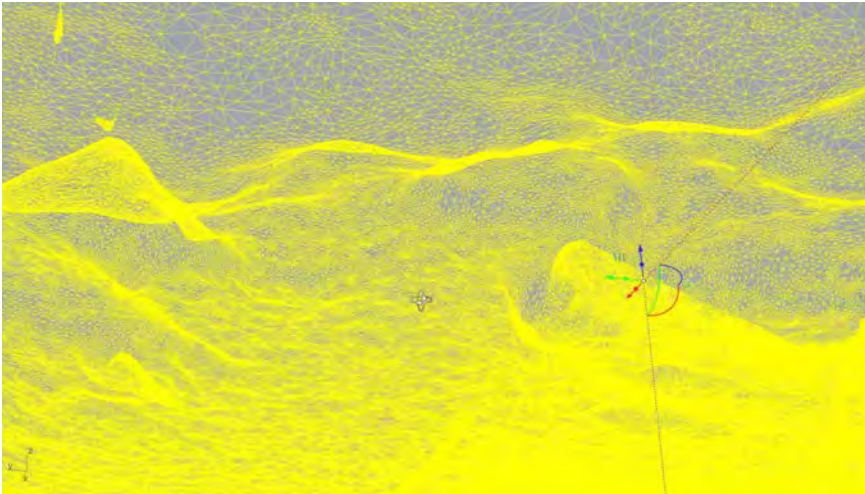
Step 1: A forced dust ejection from a container with a 2' by 2' opening coupled with a fan creates a dust swirl measuring 4' in height, which is large enough to allow for continuous photography as the photographer walks around the cloud as quickly as possible.

Step 2: The dust cloud is photogrammetrically captured using a smart phone camera directed perpendicularly at the plume's vertical direction while moving around it in full circle. This produces hundreds of photos, depending on the photographer's speed.

Step 3: The photos are imported and processed in AutoDesk Recap software, which uses visual data to reconstruct a three-dimensional digital representation of the dust plume. The method relies on visually scanning and processing data of particulate matter capable of emitting electromagnetically radiant information. The constraints of the scanning rely on the camera's ability to detect physical objects no smaller than 4-5 ml, or .001 inches. While dust particles are 2.5-5 microns in size, alone they are imperceptible, however, when simulated as an expulsion of dust by air pressure, the mini dust cloud is detected as a continuous object where the outer edges of the form are registered as topographically



different from their context (fig. 1). The global particle behavior gives the cloud ability to enter within the camera's visually observable threshold, which orients the optics of dust towards formational densities rather than molecular characteristics. Like any field observation, the measurements are affected by uncontrollable environmental inputs, which the drawing prototype attempts to accept and allow for by scanning multiple clouds in varying light, temperature, and background settings (3 scans).



**Figure 1:** Digital Mesh Reconstruction of a Scanned Dust Cloud. Source: (Author 2019).

## 2.2 Analog and Digital Spatial Correlations

Step 4: The reconstructed digital object is imported into Autocad as a three-dimensional point cloud. In order to locate each particle within the global geometry of the cloud, progressive sections are cut at specified distances from the 0,0,0 plane of the model vertically and horizontally. The sectioning distance can be set based on the units of the model and to the capacity of the machine to calculate high or low levels of data points. The tangents of the curvatures in the section geometry can be calibrated to a desired density, which also relies on computing capability.

Step 5: The digital model—as a mesh—with the section lines and all tangents are imported into Rhinoceros, where the progressive sections and tangent locations carry a set of primary geometry x,y,z coordinates (fig. 2).

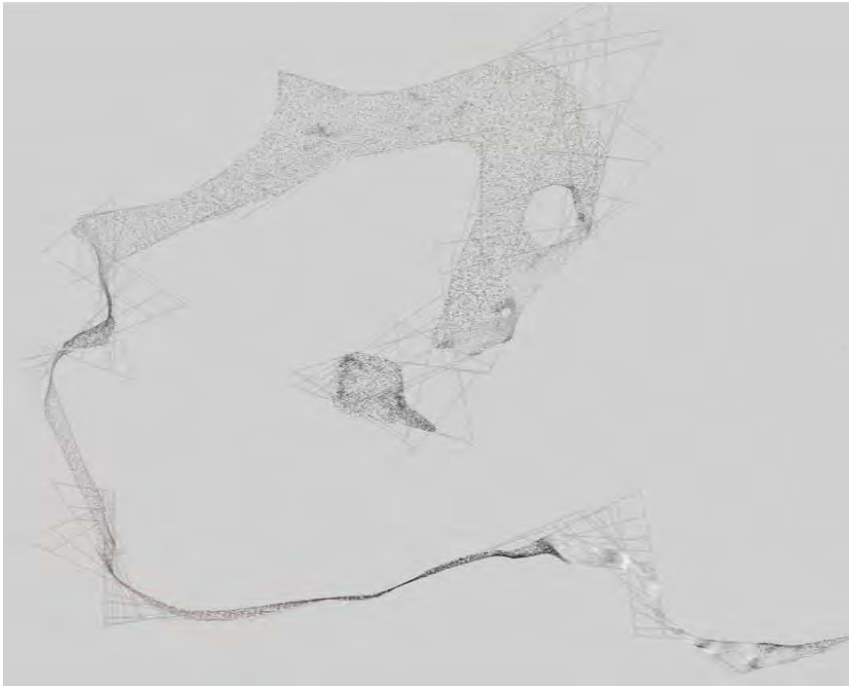
Step 6: The coordinate system is used to locate measurable points along the isocurves of the mesh and to orient an orthographic projection of all points of the model onto a flat plane. The projection registers density variations which describe the localized behaviors of particulate matter, in effect correlating geometric patterns with densities in space (fig. 3). The projection script uses a scanning plane which slides along the complex surface of the dust cloud model detecting the location of each particle and projecting it onto a plane which moves orthographically in sync with the scanning plane.

Using traditional plan and section slicing with orthographic projection techniques builds upon standard architectural tropes to detect changes of form in time, while highlighting the question of frequency or proximity of the 'cut.' While the most complex architectural forms are described by multiple floor plans or sections, the suspended dust formation requires as many drawings as there are particles moving at any given fraction of a second. The project recognizes that processing the amount of information to describe such density would require machine power and digital storage space not readily available or affordable by the demographic it aims to support. However, by testing the digital workflow for scanning a prototypical small dust formation in an indoor environment, the project can plan for the potential to scale up and embed the calculations within the power of a digital app on a smart phone. If the app is distributed to the existing personal weather stations, run and maintained by private citizens along the US-Mexico border, it could help construct countless digital models of dust devils, which can be passed through the digital workflow. The orthographic projection analysis of the models would be catalogued and sorted by season in order to establish a correlation between temperatures and particulate matter density—higher particulate matter concentrations in the air cause higher risks of negative health impacts (EPA). The catalogue would be published as an almanac, which can be distributed along known routes of pedestrian migration south of the border, and at known crossing locations that avoid the border wall, much like the water stations established by Humane Borders.

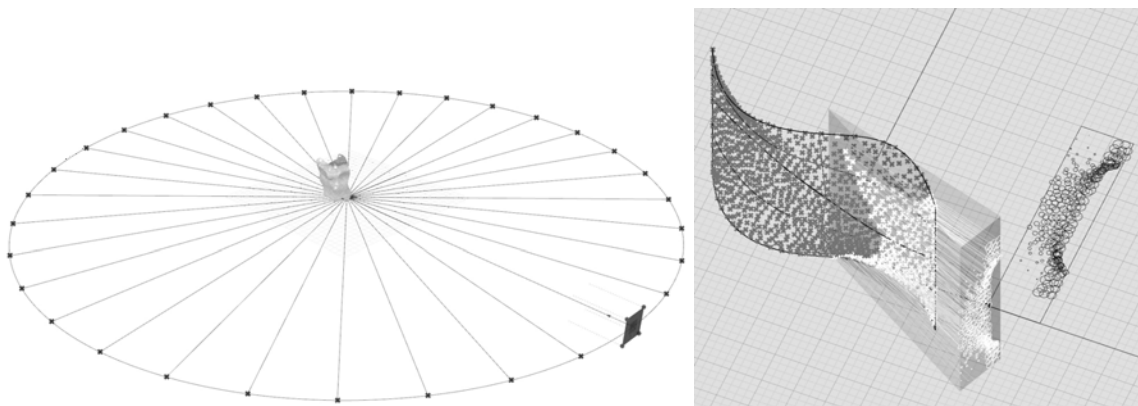
Standard instrumentation of small dust formations, particularly dust devils, uses microbarometers, which record temperature changes and can predict whether a drastic differential will produce a dust devil or other similarly scaled



events. When paired with the visual representation of this workflow, a new visualization can offer topological information that is both predicable and visually understood in terms of complexity. If dust formations can be scanned with a mobile telephone camera and their densities analyzed in terms of their effects on respiratory health risks, the data gained has the potential to alter people's relationship to the desert. By embedding cross-platform calculations into a visualization procedure, the elusive nature of small-scale spontaneous dust formations can be captured, and anticipated, and potentially avoided. This method aims to disseminate prototypical studies as a sampling of events, which over time, would produce a catalogue of potential small dust event forms, which can be referenced much like a farmer's weather almanac.



**Figure 2:** Tangents Describing the Isocurves of the Dust Model. Source: (Author 2019).



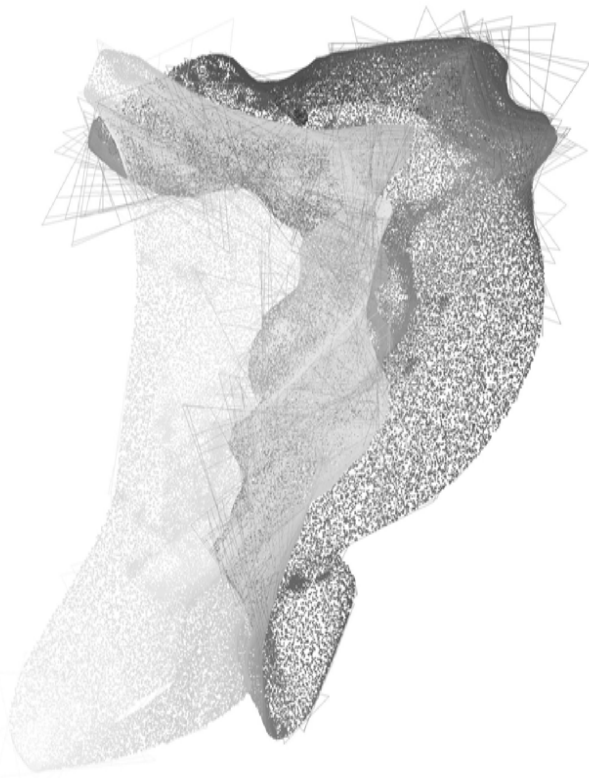
**Figure 3: A.** Orthographic Projection of Particulates of Dust Formation Model. **B.** Projection Test on Prototypical Surface. Source: (Author 2019).

## CONCLUSION

The Chihuahua and Sonoran Desert regions along the US-Mexico border will continue to play an important role in the expansion of the nation's surveillance system. As global warming accelerates desertification rates and intensities, the dangers of increased densities of particulate matter in the air will continue to disproportionately impact the most vulnerable—undocumented border crossers and border communities. Designers can play a role in this extreme context. The discipline's toolsets are capable of visualizing objects from the scale of particulate matter to that of entire territories.

By calibrating standard architectural tools and procedures to correlate the nearly invisible with visible information, traditional devices such as plans and sections gain urgent agency. The second digital turn in architecture allowed for a renewed relationship with craft by using digital modeling and rapid prototyping to quickly iterate outcomes towards a desired specificity (Carpo). While computational workflows are designed to translate digital models into physical assemblies, the scanning project proposes to work in the opposite direction. Although the proposed method works from physical to digital formations, it relies on standard architectural tropes as a way to anchor topological relationships and geometrical analysis. The findings build upon the discipline's interest in relationships between digital, virtual, and analog logics, where the digital is a faithful replication of the analog, while the virtual is a possibility of the analog (Lynn). The analog-to-digital-to-virtual workflow, when coupled with the visual recording of politically charged dust formations, has the potential to invert the power structures of vision. As the securocratic surveillance infrastructure of the border instrumentalizes climate change to its advantage, by using it to amplify its panoptical vantage point towards an omnidirectional vision, the project builds knowledge and reverses the use of dust to the people's advantage.

The view from above, which flattens the territory into documented vs undocumented movement, and visible vs invisible binaries, is unaware of microevents, geologic nuances, material shifts, cultural space, and the visual field of an individual on the ground. The three-dimensional scanning at eye level, on the other hand, deconstructs the geometry of the dust formation to map its particulate matter movement and relational behavior, which may highlight dust composition and structure, at hyperlocal levels and relates the structural and formal data to unique contextual perceptions and understanding. The technique is visual, and as such it is a primary tool of optics, which is the very sensing tool used by the surveillance apparatus. By using a mobile phone as a means to radically mobilize and crowdsource the gathering of information of visual perception on the US-Mexico border, the project raises questions of surveillance, its expansion, its goals, tools, and directionality.



**Figure 4:** Digital Reconstruction of a Scanned Dust Cloud. Source: (Author 2019).

## ACKNOWLEDGEMENTS

Project was made possible in part by a prototyping grant from Institution [details omitted for peer-review].  
Project team credits [details omitted for peer review].

## REFERENCES

- Carpo, Mario. 2017. *The Second Digital Turn*. Cambridge: MIT Press
- Fischer, Adelheid. and Taylor James. 2017. *Documenting the Undocumented*. Places Journal. Accessed January 24, 2021.
- Gonzalez-Barrera, Ana. 2020. *After Surging in 2019, Migrant Apprehensions at U.S.-Mexico Border Fell Sharply*. Pew Research Center. Accessed January 24, 2021.
- Human Rights Watch. 2020. *Trump Administration's "Remain in Mexico" Program*. Human Rights Watch. Accessed January 24, 2021.
- Kotvis, Jill A. 1996. *NAFTA's Impact on the Environmental Management of the U.S./Mexico Border Lands*. Vol. 2. No. 2. Law and Business Review of the Americas.
- Kripa, Ersela. 2019. *Desert Densities - Sensing Atmospheric and Territorial Shifts in High-Density Desert Cities*. 107<sup>th</sup> ACSA Annual Meeting Proceedings.
- Kripa, Ersela. and Stephen Mueller. 2016. *The Infrastructures of Dust*. ACSA International Conference Proceedings.
- Lynn, Greg. 1999. *Animate Form*. Princeton: Princeton Architectural Press.
- NOAA. 2017. *It's a Dusty World: NOAA Satellites Help Us Keep Track of It*. National Environmental Satellite Data and Information Service.
- Reiss, Dennis. 2018. *Dust Devils: Stirring up the Martian Surface*. Dynamic Mars: Recent and Current Landscape Evolution of the Red Planet. Amsterdam: Elsevier.
- U.S. Environmental Protection Agency. 2010. *Quantitative Health Risk Assessment for Particulate Matter*. The Office or Air Quality Planning and Standards.
- Wunderground.com. Accessed February 21, 2021.

# Performing Air: Landforms and Ventilation

Gabriel Fries-Briggs<sup>1</sup>

<sup>1</sup>University of New Mexico, Albuquerque, NM

**ABSTRACT:** Air vents and ducts trace a 20th century history of building mechanization and the standardization of interior climates. The vent and its corollary material systems stand in for countless episodes where building design became increasingly inseparable from mechanical determination. Understanding the ubiquity of air conditioning requires untangling the architectural profession's implication and cultural-reliance on these technologies. As an assemblage of entities, ventilation threads together a social-ecological-technical system.

This paper outlines an alternative formation of air in architecture, addressing built form as an unexpected assemblage of entities through a reshuffling of technological systems. It positions Dune Ducts, a recent gallery installation in Los Angeles, as an alternative methodology for thinking through ventilation. Dune Ducts augmented the mechanical infrastructure of an existing building system. The newly installed ductwork replaced the existing system of diffusers, a ventilation prosthetic distributing conditioned air across the interior. This reshuffling of air's visual and historical formations link landscape, environment, comfort, and building systems.

Sand dunes present an alternative image of air as built form. Wind-driven landscapes, assembled by aeolian processes, depict forms conditioned by air outside the traditional 'built environment.' In looking to geology and meteorology, the installation-as-building-fragment combines diverse origins of ventilation. The inertia of systems design and the predetermination of ventilation through standards require a rewiring in light of both climate change's effects and the spread of pathogens. This paper proposes a shift to spatial, formal, and planetary considerations as means to rethink the performance of air.

**KEYWORDS:** Environment, Building Systems, Design Methods, Installation

## INTRODUCTION

Air vents and ducts trace a 20th century history of building mechanization and the standardization of interior climates. In reflecting on the "function of architecture," artist Daniel Buren distinguishes between "so-called neutral architectural places," finding their apotheosis in the white cube, and non-neutral architecture (Buren 1996, 224).<sup>1</sup>

[T]he non-neutral points/axes breaking the neutrality and generally never used for this reason - are the windows, the doors, the narrow corridors, the air vents, the heating pipes, the light sources etc.... In fact, holes in architecture (Buren 1975, 125).

Buren's categorization of neutral places and non-neutral holes services multiple readings. On the one hand, he frames an encounter between art and architecture suggesting ways artists might relate to the edifice of exhibition and the particularities of site. On the other, Buren points to a blind spot—holes in architecture's historical and industrial trajectory. The air vent and its corollary material systems stand in for countless episodes where building design is inseparable from mechanical determination.

## 1.0 FORMS OF AIR

### 1.1. Mechanical Determination

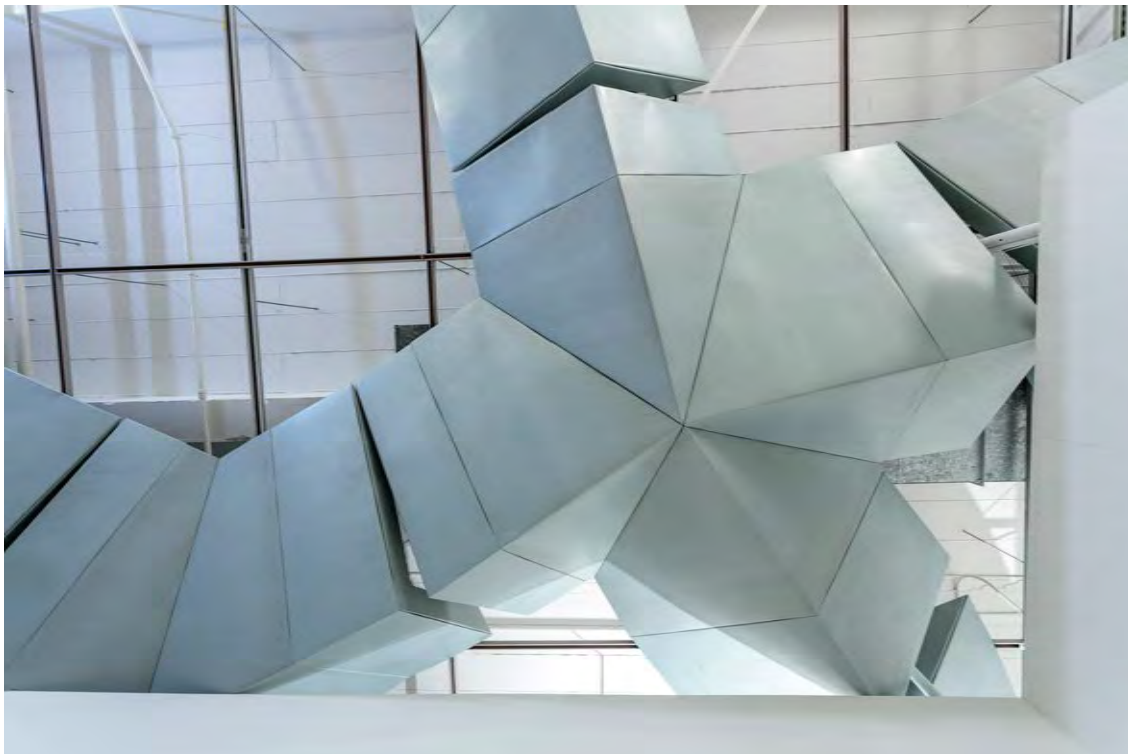
That mechanical ventilation has shaped architecture and exerted immense pressure on the organization of interiors comes as no surprise. The incorporation of air conditioning into buildings and its effects are well documented (Moe 2011). Reyner Banham not only revealed in the impact of environmental engineering on architecture, but as Michael Osman puts it, Banham worked to "dissolve any specific forms of architectural knowledge into the expanded field of environmental management" (Osman 2018, xvi). In this ontological rewiring, the formative technologies of air conditioning are not neutral, they are central motivations of any incidental built forms. Taking a broad view of technologies, Bruno Latour criticizes both neutral and positivistic characterizations.

The paradox of technology is that it is always praised for its functional utility, or always held in contempt because of its irritating neutrality, although it has never ceased to introduce a history of enfoldings, detours, drifts, openings and translations that abolish the idea of function as much as that of neutrality (Latour 2002, 255).

Latour calls for a reading of technology through “unexpected assemblages of entities” (Latour 2002, 255).

The architectural profession is implicated in the ubiquitous use of conditioned air to heat and cool spaces despite its inefficient use of energy. This can be partly attributed to a cultural reliance on these technologies that reinforces their implementation in architecture and construction beyond their utility and privileges their use over other techniques for thermal regulation. Buren’s vents and their related systems of conditioning should not be read on binary lines as merely-functional apparatuses nor as autonomous technologies-gone-crazy<sup>2</sup> capable of self-perpetuation. To use Latour’s terms, a history of “enfolding, detours, and drifts” characterize the interdependence of HVAC technologies and the design and building professions.

Similarly, visions of a sustainable future too often fall down the same ‘functional’ rabbit hole, arriving at prescriptions that promote false binaries. These might include replacing the infrastructure of air conditioning in its entirety in favor of more efficient systems for heating and cooling (scraping the entire assemblage) or continuing to rely on thermal exchange via air but with incremental improvements to sustainable technologies (systems inertia). These solutions address the functional performance of HVAC in light of climate change and global warming. However pressing issues in particular tend to be seen in technological terms, masking a cultural crisis as an environmental one for example (Cruz 2011). The installation Dune Ducts addresses mechanical ventilation as an unexpected assemblage of entities, reshuffling technological systems and multiple, overlapping readings of ‘performance.’



**Figure 1:** Dune Ducts installation seen from below. Source: (Author 2019)

## 1.2. Design Tools

Dune Ducts (Figure 1) was built to the specifications of historical artifacts surrounding ventilation—standards, geology, industrial modes of production, and the material facts of existing building systems. This assemblage of entities describes forms of air and built forms arising from air. The standards of mechanical ventilation are produced in the constant performance of building design, its technological and managerial activities. The “Sample Systems Project,” offered up by Revit upon opening the program and shown in Figure 2, encapsulates the agency of standards in the architectural imagination.<sup>3</sup> A complete system with duct elbows, transitions, diffusers, grilles, and a cooling tower, the preloaded assemblies and libraries stage the information-rich history of technological progress.

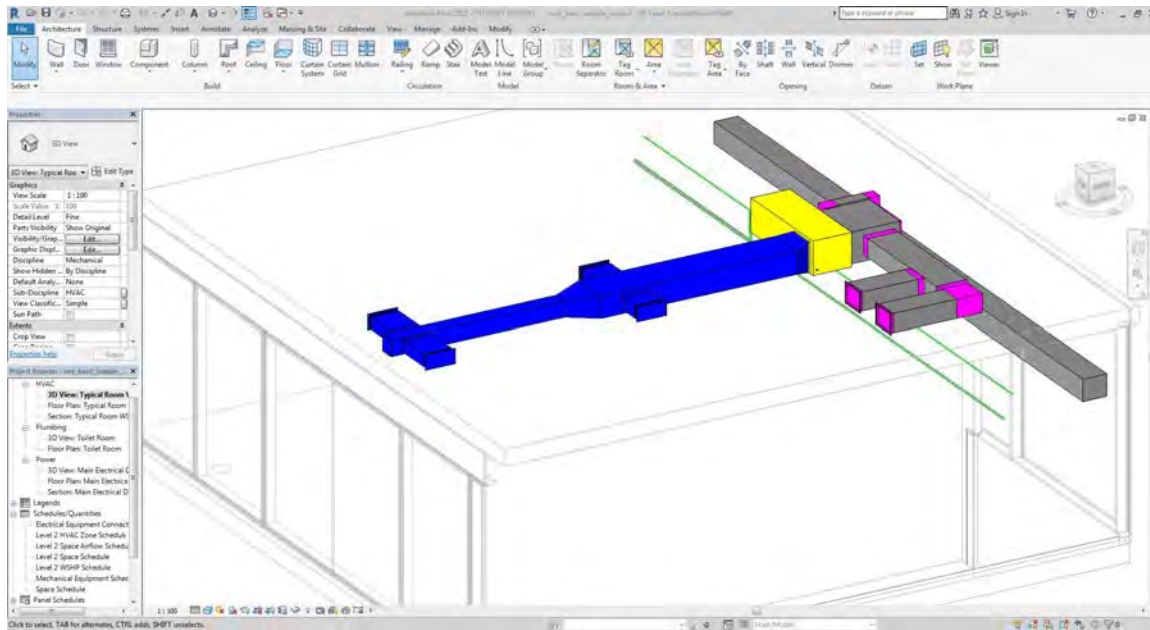


Figure 2: “Sample Systems Project,” in Revit 2018 by Autodesk. Source: Screen shot by author, 2020.

### 1.3. Aesthetics of Industry

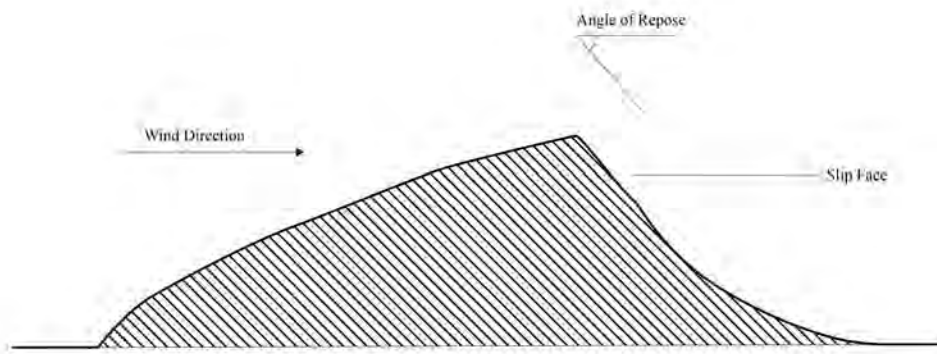
With the inertia of entire industries, never mind the ease of dropping in a BIM family, mechanical standards are sure not to disappear anytime soon.<sup>4</sup> Globally, 110 million air conditioning units were shipped in 2018 with the energy demand from air conditioners expected to triple in the next thirty years (*The Future of Cooling* 2018). In the United States, the HVAC industry takes in 96 billion dollars in annual revenue, employing over half a million people (Wang 2019). Given the expanse of industry and expertise, techniques of duct fabrication form a well codified body of knowledge adjacent to architectural assembly. The complex system of manual and automated labor—the rolling, stamping, shearing, and folding of sheet metal<sup>5</sup>—exemplified provides a toolkit for refashioning forms of ventilation. The geometries of ducting however are not predetermined or limited by the techniques of fabrication. As Dune Ducts seeks to emphasize, taking stock of the expertise and methods of assembly can open alternative formations.

A history of the formal articulation of conditioning systems is too long to address here, but practitioners, such as Richard Rogers, entering the profession during the environmental movement of the 1960s found exuberant expression in the mechanical motifs of ducts (Figure 3). Perhaps not surprisingly, the buildings that emerged from this movement generally clung to images of mechanical progress and industrial objects rather than extend beyond the formalism of pre-packed systems. Techniques of craft like those embodied in the manufacturing of HVAC, suggest a way to learn from techniques of production to devise and fabricate new forms of interior environments.



Figure 3: Ventilation fixtures at 88 Wood Street by The Richard Rogers Partnership, constructed 1994-98. Source: (Ford 2008).

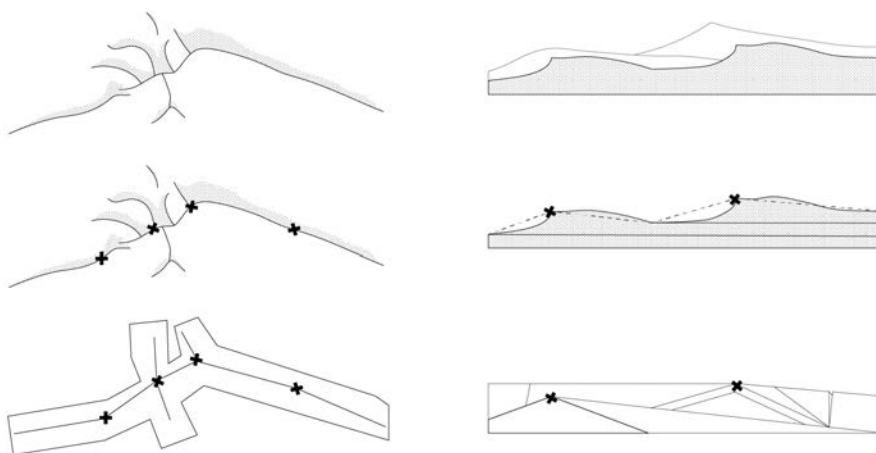




**Figure 4:** Cross section of an aeolian sand dune. Source: (Author 2020)



**Figure 5:** MacOS Mojave desktop wallpaper. Source: (Apple Inc. 2018)



**Figure 6:** Illustration of dune morphology and abstraction as sheet metal ducting. Source: (Author 2020)

### 1.4. Aeolian Landforms

Sand dunes present an alternative image of air as built form. Wind-driven landscapes, assembled by aeolian processes, depict forms conditioned by air outside the traditional 'built environment.' The erosion, transportation, and deposition of sediment by wind manufactures a common profile with a long shallow angle (stoss) facing the wind, a crest, and steep lee side as shown in Figure 4 (Pye and Tsoar 2009). In looking to geology and meteorology, Dune Ducts reshuffles the influences and origins of ventilation. And yet landforms are also already-commodified forms, mediated by ubiquitous technology. The default wallpaper of MacOS Mojave delivers 'nature' on startup; high-res transportation for everyday computing. The desktop background (Figure 5) portrays the Dumont Dunes, 160 miles northeast of Los Angeles, in Death Valley.<sup>6</sup> This seemingly simple image (was it captured on an iPhone?) belies the fact that it's a highly artificial construct, an assemblage of many images and technologies. This image is borrowed again. It provides the layout for Dune Ducts as described in Figures 6 - 8, cutting across geographies and mechanized systems of air through the portability of technological abstraction.

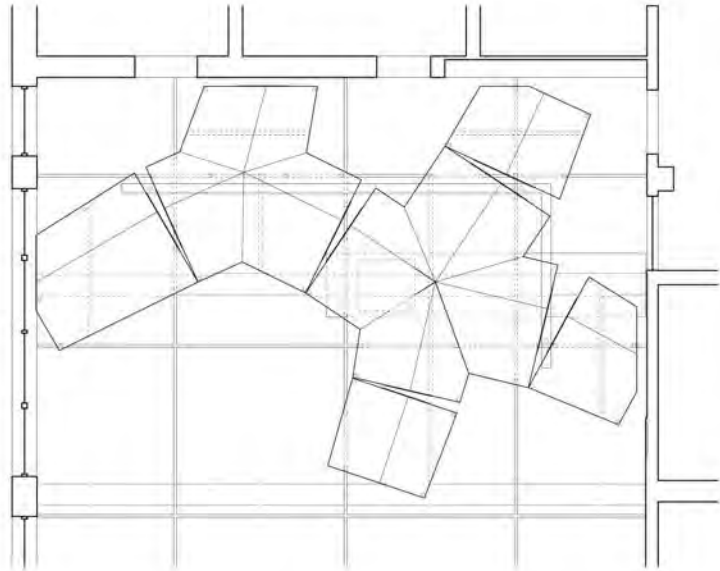


Figure 7: Reflected ceiling plan. Source: (Author 2019)

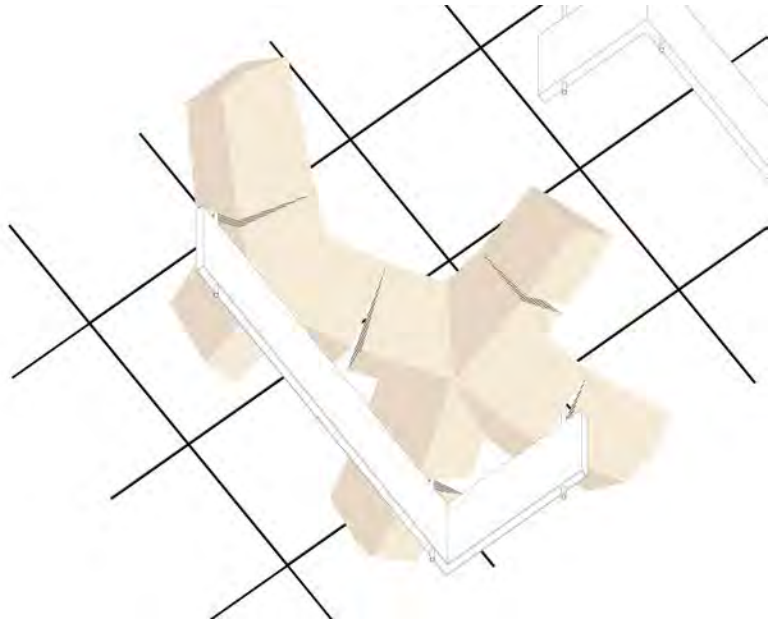
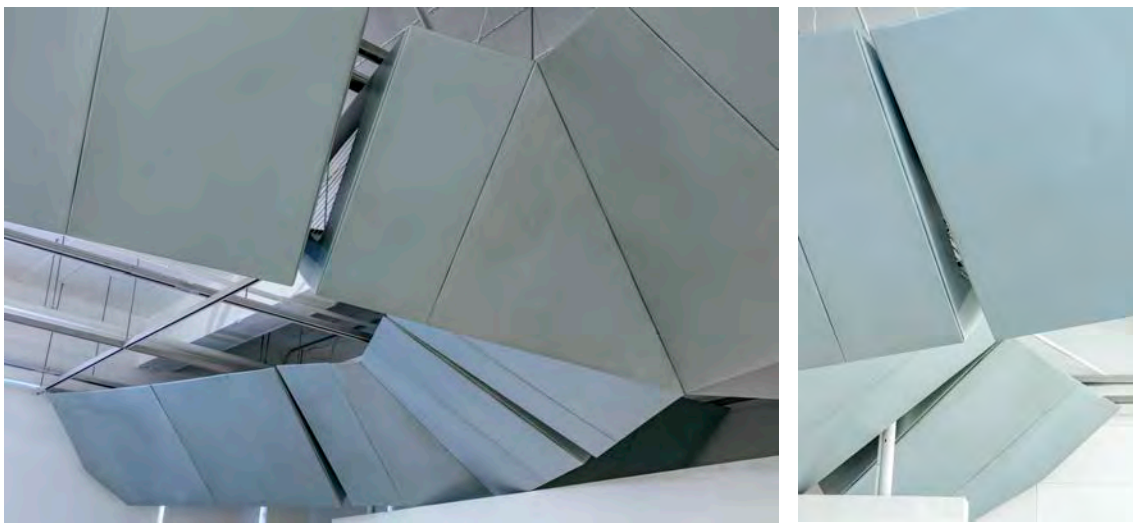


Figure 8: Isometric drawing of Dune Ducts installation. Source: (Author 2019)

### 1.5. Dune Ducts

Dune Ducts is conceived as a building fragment, an unexpected assemblage of entities forming part of a ventilation system (Figures 9 and 10). The installation, created by the author and opened in October 2019, builds on the found systems of the gallery environment. Rather than scrapping or ignoring the conditions of site, it plugs into the material infrastructure of an existing air conditioning system. The newly installed ductwork replaces the existing diffuser, a prosthetic distributing conditioned air across the interior. This air is projected downward at breaks in the form, gaps at kinks and bends in the metal dune. Walking around the gallery, occupants feel little gusts of wind at each break in the dunes. These gaps, the non-neutral holes in architecture, link landscape, environment, comfort, and building systems via the air. As an assemblage of entities, ventilation threads together a social-ecological-technical system.

The full-scale building fragment, akin to the mockup, is an opportunity to focus attention on those qualities of building that may often go unseen and to isolate aspects of performance.<sup>7</sup> The installation brought together multiple registrations of performance including technical (ventilation), active or bodily (experiencing gusts at dune breaks), and aesthetic (as an object in the gallery). Fragments, given the right dimensions, skirt the boundaries of space and things.<sup>8</sup> In the exhibition venue or the gallery, the traces of existing artifacts can be pulled forward and layered on top of (or below). It makes clear that there is no tabula rasa for built work, only non-neutral architecture. In other words, the building fragment tests variables against the contingencies of sites and environment.



Figures 9 and 10: Dune Ducts installation view. Source: (Author 2019)

## 2.0 CONSIDERING AIR BEYOND NEUTRALITY

### 2.1. Air Quality Index

Beyond its conditioning and effects on architecture, air itself is not neutral. Two recent events, concurrent with this project, reflect this quality in less-than-subtle ways. While they are not explicitly related to the installation, they are central elements in a cultural context surrounding the project and contemporary discourse around ventilation more generally. The first event is the Getty Fire which broke out around 1:30 AM on October 28th, the opening day of the installation and less than three miles down the road. The fire started with a spark caused by a tree branch that broke off and fell onto powerlines causing them to arc (*Getty Fire* 2019). Over the next week, 745 acres of mostly hillside burned in the middle of Los Angeles. The fire was fanned by gusts of wind up to 50mph, a part of the phenomena known as the Santa Ana winds, when high-pressure air from eastern deserts seeks a path through Southern California's Transverse Ranges to fill lower-pressure voids on the coast (Vivies and Lin 2019). Wildfire smoke, a collection of solids, liquids, and gases emitted by combustion (Irfan 2019), blankets areas of California on a yearly basis, transforming air quality from "unhealthy" to "very unhealthy" (EPA 2019). While other forms of toxic air pollution have a more continuous presence and pose a health risk to more people globally (*State of Global Air* 2018), the danger and suddenness posed by wildfire smoke render visible the precarity of healthy air.

### 2.2. Respiratory Disease and Ventilation

On February 10th, 2020, an email newsletter solicited "an engineering perspective on cruise ship ventilation systems and the Diamond Princess" (Weinhoffer 2020). A group of people on board the ship being held in the port of Yokohama were seeking information about the effectiveness of cruise ship mechanical systems to mitigate transmission of airborne infections. While some of these questions leapt from quarantined ships, the following months led to a surge of research and media coverage around the ability of mechanical ventilation to filter viral particles. Concerns of outdoor air quality

have been usurped by the separation of interior spaces. Conditioning systems are being newly evaluated for their capacity to slow the spread of coronavirus—isolating via air the socially-imagined bubbles around bodies occupying shared interiors. While our reliance on technologies of ventilation and filtration is never more apparent, it supports Latour's formulation of an always-present human-mechanical dependence. "There is no outside: outside is another inside with another climate control, another thermostat, another air-conditioning system" (Latour 2008). A further dependence on mechanical breathing is found in those most severely affected by COVID-19, a turning inward of mechanical ventilation into the body through ventilators. In critically short supply during pandemic surges, the race to produce ventilators has led to a reconfiguration of the 20th century's dominant industrial forces as manufacturers in the automobile supply chain shift to making ventilator parts (Albergotti and Siddiqui 2020). As Michael Osman notes, the astronaut's space suit was for Reyner Banham the point of maximum fitness between the architectural environment and its user. In an era of severe wildfire smoke and pandemic respiratory-disease, the management of less-than-neutral air might find its apotheosis in the N95 respirator.

## CONCLUSION

Despite its inefficiencies, air conditioning persists as a primary means of thermally regulating the interior. Its inertia in design practices can be read through a history of the entanglements, drifts, and detours between technology and architects (and builders). Dune Ducts seeks to visualize multiple formations of air. It takes mechanical ventilation as an unexpected assemblage of entities—historical, technical, and cultural. Reshuffling the categorical definitions and forms of air links landscape, environment, comfort, and building systems, countering the tendency to minimize the visibility of supporting systems. While this installation focuses on the coming together of landforms and mechanical equipment as a particular fusion of built forms arising from air, air quality issues and respiratory disease give further urgency and new concerns to visualizing and considering the performance of air.

## ACKNOWLEDGEMENTS

All photographs of the Dune Ducts installation were taken by Joshua White.

## REFERENCES

- Albergotti, R. and Siddiqui, F., 2020, "Ford and GM are undertaking a warlike effort to produce ventilators. It may fall short and come too late." *The Washington Post*, April 4, <https://www.washingtonpost.com/business/2020/04/04/ventilators-coronavirus-ford-gm/>.
- Buren, D., 1975, "Notes on work in connection with the places where it is installed, taken between 1967 and 1975, some of which are specially summarized here for the September/October 1975 edition of *Studio International*," *Studio International* volume 190, Number 977, September/October 1975: 124-5.
- Buren, D., 1996, "FUNCTION OF ARCHITECTURE: on work in connection with the places where it is installed taken between 1967 and 1975, some of which are specially summarized here," in *Thinking about Exhibitions*, ed. Reesa Greenberg, Bruce W Ferguson, Sandy Nairne. New York: Routledge, 222-76.
- Cruz, T., 2011, "Letter to the Profession of Architecture," *New Directions in Sustainable Design*, ed. Adrian Parr, Michael Zaretsky. New York: Routledge, 2011, 3-5.
- EPA, 2019, "Air Quality Index (AQI) Basis," last updated June 18, 2019, <https://cfpub.epa.gov/airnow/index.cfm?action=aqibasics.aqi>
- The Future of Cooling*, International Energy Agency, 2018. <https://www.iea.org/reports/the-future-of-cooling>.
- Getty Fire*, Los Angeles Fire Department, last updated November 5, 2019. <https://www.lafd.org/news/getty-fire>.
- Irfan, U., 2019, "Wildfires are making California's deadly air pollution even worse," *Vox*, October 28, <https://www.vox.com/2019/10/28/20936357/california-wildfire-air-quality-health-pollution>.
- Moe, K., 2011, "Technique is the Architecture of Sustainability," in *New Directions in Sustainable Design*, ed. Adrian Parr, Michael Zaretsky. New York: Routledge, 2011, 173-84.
- Latour, B., 2002, "Morality and Technology," *Theory, Culture & Society* volume: 19, issue: 5-6, December, 247-260.
- Latour, B., 2008, "A Cautious Prometheus? A Few Steps Toward a Philosophy of Design (with Special Attention to Peter Sloterdijk)," keynote lecture, "Networks of Design" meeting, Design History Society, Falmouth, Cornwall, September 3, 2008, cited in Michael Osman, *Modernism's Visible Hand* (Minneapolis: University of Minnesota Press, 2018): xviii.
- Osman, M., 2018, *Modernism's Visible Hand*. Minneapolis: University of Minnesota Press, 2018: xvi.
- Pye, K., and Tsoar, H., 2009, *Aeolian Sand and Sand Dunes*. Berlin: Springer.
- State of Global Air 2018*. Health Effects Institute, 2018. Special Report. <https://www.stateofglobalair.org/sites/default/files/soga-2018-report.pdf>
- Vivies, R. and Lin, R-G., 2019, "Getty fire rains smoke and ash on Los Angeles Basin, creating hazardous air," *Los Angeles Times*, October 28, <https://www.latimes.com/california/story/2019-10-28/getty-fire-smoke-ash-los-angeles-bad-air>.
- Wang, T., 2019, "Key information on the heating, ventilation and air conditioning (HVAC) industry in the U.S. as of January 2019," Statista, <https://www.statista.com/statistics/964299/hvac-industry-select-data-us/>
- Weinhoffer, E., 2020, "The Prepared," February 10. <https://mailchi.mp/theprepared/457j52c56q-1951071>

## ENDNOTES

<sup>1</sup> In a reprint of Daniel Buren's text, this piece is titled 'Function of Architecture'. Daniel Buren, "FUNCTION OF ARCHITECTURE: on work in connection with the places where it is installed taken between 1967 and 1975, some of which are specially summarized here," in *Thinking about Exhibitions*, ed. Reesa Greenberg, Bruce W Ferguson, Sandy Nairne (New York: Routledge, 1996), 222-76.

<sup>2</sup> Adapted from Bruno Latour's term, "technology-that-becomes-crazy-because-it-has-become-autonomous-and-nolonger-has-any-other-end-except-its-goalless-development," in Bruno Latour, *ibid.* 255.

<sup>3</sup> For an in-depth reading of Revit's Sample Projects see Amelyn Ng, "OOTB", *e-flux architecture Positions* (August 2019). <https://www.e-flux.com/architecture/positions/280207/ootb/>

<sup>4</sup> Severe weather related to climate change is often cited as increasing the demand for mechanical conditioning despite its relationship to the causes of climate change.

<sup>5</sup> While rigid ducts are still primarily made of galvanized steel, the material has expanded to incorporate plastics, aluminum, fiberboard, fiberglass, and textiles.

<sup>6</sup> As Apple does not release information about their wallpapers. This is the location commonly believed to have provided the source material for the image(s).

<sup>7</sup> Not to mention that for many practitioners, particularly young architects, the mock up and gallery installation are often one of the few opportunities available to test and develop built work.

<sup>8</sup> Thanks to Cristobal Amunategui for suggesting this reading of the installation.

# Parks as Performative Landscapes: Networked Green Infrastructure for a Flooded Desert City

Courtney Crosson<sup>1</sup>

<sup>1</sup>University of Arizona, Tucson, AZ

**ABSTRACT:** Cities regularly seek to optimize the value of each single infrastructural investment to their citizens. When city parks are viewed solely as spaces for recreation, important performative landscape benefits are not optimized. Six parks slated for park bond investments that currently experience chronic flooding during monsoon season in Tucson, Arizona were designed. The computational fluid dynamics software, Flo2D, provided iterative results for performance optimization. The six park designs created a network of performative landscapes able to provide an additional 3.5 million gallons of distributed flood water storage to the city with additional benefits such as habitat restoration and heat island mitigation. Parks with the largest areas and highest existing flooding volumes were most effective at contributing to overall watershed flood mitigation. Smaller neighborhood interventions offered important, localized mitigation and other benefits, but contributed minimally to alleviating wider watershed flooding issues. This paper concludes that early collaboration between architects, municipalities, and citizens can ensure infrastructural investments are optimized to achieve multiple purposes for the greatest value to the city and benefit to the local community. Modeling and monitoring the technical performance of green infrastructure is critical to expanding urban resilience and multi-benefit infrastructure.

**KEYWORDS:** performative landscapes, green infrastructure, urban parks, hydrological modeling, flood mitigation

## 1.0 INTRODUCTION

Municipalities with limited budgets often seek to optimize the value of each single infrastructural investment to their citizens. When city parks are viewed only as spaces for recreation, important performative landscape benefits are not optimized. Tucson, Arizona recently approved a comprehensive bond to renovate and expand the city park system over the next ten years. Given these slated investments, this research investigated how the City could provide additional value beyond the traditional neighborhood park assets listed in the bond. Tucson has the highest yearly extreme storm count across Western US Metropolitan Statistical Areas and averages \$9.5 million in property losses each year from flooding where stormwater infrastructure was historically not installed (Bakkensen and Johnson, 2017). This chronic flooding occurs at peak events during the North American Monsoon season. This research framed the urban park system as a potential network of performative landscapes able to provide critical urban flood mitigation throughout the city while contributing additional benefits such as habitat restoration and heat island reduction.

This paper starts with a review of recent literature on performative landscapes, green infrastructure, and hydrological flood modeling. Then, research methods are outlined. Results are discussed for six parks designed through an upper-level architecture studio. These parks represented six dominant land use typologies: large park, neighborhood park, church yard, abandoned lot conversion, industrial conversion, and strip mall conversion. The computational fluid dynamics software, Flo2D, provided the iterative flood mitigation performance results to the student design teams. Design teams also carried out community engagement activities to identify local neighborhood needs. This paper argues that by working across disciplines and departments, early collaboration can ensure infrastructural investments are optimized to achieve multiple purposes for the greatest value to the city and benefit to the local community. Modeling and monitoring the technical performance of green infrastructure is critical to expanding urban resilience against acute and chronic shocks. This is an evidence-based approach for landscape and infrastructure development.

## 2.0 LITERATURE REVIEW AND BACKGROUND

### 2.1. Performative Landscapes and Green Infrastructure Design: Benefits and Challenges

Urban performative landscapes mediate between the natural environment and urban built environment. As cities have continued to densify and increase impervious surfaces while decreasing permeable areas, the urban water system has suffered direct detrimental impacts. Performative landscapes realized through the urban park system can offer a solution. "The timing and magnitude of runoff, flooding, and aquifer recharge can be strongly influenced by changes in land cover, including, particular, alterations that change the water storage potential of the system (Meiklejohn et al., 2009)." Performative landscapes work to address these negative consequences of urban development by providing



permeable areas for stormwater treatment, storage, and infiltration. Performative design of these landscape areas is necessary to maximize potential benefit.

There are a host of large, medium, and small scale green infrastructure design elements that have been proven to mitigate urban flooding and together form performative landscapes. The Environmental Protection Agency defines green infrastructure as “an approach to water management that protects, restores, or mimics the natural water cycle and one which is effective, economical, and enhances community safety and quality of life (EPA 2020).” These elements include basins (Belizario et al., 2016), bioswales (Lucas et al., 2015), and bioretention (Lucke and Nichols, 2015). Where gray infrastructure tends to be designed to perform a single function, green infrastructure serves multiple purposes and provides a range of services from engineering, environmental, to human benefit (Ely and Pitman, 2014). Literature on the functions and benefits of performative landscapes and green infrastructure frame effects from global to local scales. Studies have investigated the benefits of green infrastructure for hydrological regulation for water quality, increased rainwater retention, reduced flood damage, improved pedestrian connectivity and safety, and expanded open public space. Green infrastructure has many documented environmental benefits or ecosystem services including erosion control, improved water quality, groundwater recharge, mitigating effects of urban heat island, wildlife habitat support, reduced energy demands for cooling, and enhanced aesthetics and access to green space (Zhang et al., 2019).

There are challenges associated with the design, planning, implementation, and maintenance of performative landscapes and green infrastructure over the long-term, which include the development of place-based design standards, regulatory frameworks and policies, continuous funding, socio-economic disparities, and the adoption of innovation (Zuniga-Teran et al., 2019). Additionally, many green infrastructure installations are not properly maintained (Roman et al. 2017) and their actual performance, particularly in the long-term, is unknown (Bell 2018 et al. 2016, Feng and Burianet al. 2016). This new paradigm of infrastructure can be challenging for a municipality to manage alongside existing grey infrastructure.

## **2.2. Assessing Stormwater Designs: Flooding Analysis and Hydrological Modeling**

Climate change is increasingly stressing the urban and natural system’s abilities to manage flood events. Recent hydrological modeling literature focuses on urban flood vulnerability with the need to evaluate network-wide impacts as well as prioritizing mitigation strategies. As hydrological modeling expertise are usually located in the flood control district, municipal park and landscape designs are often not optimized for the flood mitigation that they could contribute. Decentralized flood mitigation benefits that can be accrued through each project undertaken by a city can be lost without early coordination between hydrologists and designers (Roy et al., 2008). This project designed a set of six parks through a multidisciplinary and early coordinated effort, traversing six neighborhoods, to address urban flooding.

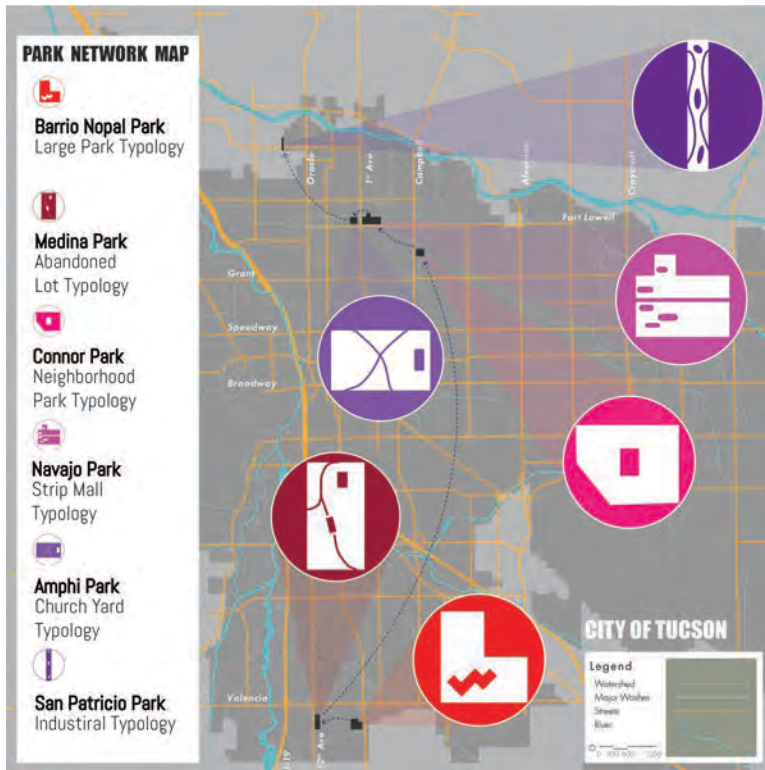
## **2.3. Proposition 407 and Research Area**

Located in the Sonoran Desert, Tucson is subject to fluctuations in daily volumes and seasonal patterns of rainfall. Tucson has a light (roughly December through February) and heavy (roughly July through September) rainy season joined by intense stretches of heat and dryness. The majority of the urban center of Tucson does not currently have storm water piping. Streets were designed to carry the heavy rain flows that occur during the winter and monsoon seasons to washes throughout the city. Over time, the city grew and greatly shifted its majority pervious land cover to impervious. Chronic flooding throughout the city center results in annual property damage and restricted mobility. To address these issues, the County and City have worked over the last decade to collaboratively develop policies to address current flooding issues and retrofit Tucson with a network of green infrastructure. In the fall of 2018, the citizens of Tucson voted for Proposition 407: Parks and Connections Bond. This bond package aims to generate \$225 million over nine years to fund a series of new and existing parks. Further, in spring 2020, the Tucson City Commissioners adopted a new Green Stormwater Infrastructure Fee, previously absent from community water bills. In contrast to the two existing fees for potable water and sewer, this third fee funds the planning and construction of a decentralized green stormwater infrastructure system throughout the city. The goal of using green stormwater infrastructure in Tucson is to reduce areas of localized flooding and improve co-benefits such as increased shade, reduced heat island effect, and decreased nonpoint source pollution throughout the city. The parks in this research project experience chronic flooding and are slated to be funded through Proposition 407 with strategic additional support from the new Green Stormwater Infrastructure Fee.

## **3.0. METHODS**

### **3.1. Public-Academic Partnership**

This paper examines this Tucson case study where a public-academic partnership was formed between County Flood Control District hydrologists and architecture students at the University of Arizona (UA). Led through an UA upper-level design studio, the partnership used spatial mapping, quantitative analysis, hydrological modeling, and design inquiry to create six parks designs that acted as performative landscapes to mitigate persistent community flooding. These parks represented six dominant use typologies: large park, neighborhood park, church yard, abandoned lot conversion, industrial conversion, and strip mall conversion (FIGURE 1).



**Figure 1:** Map of six park performative landscape network. Source: (ARCH 451b/510f studio and Author 2019)

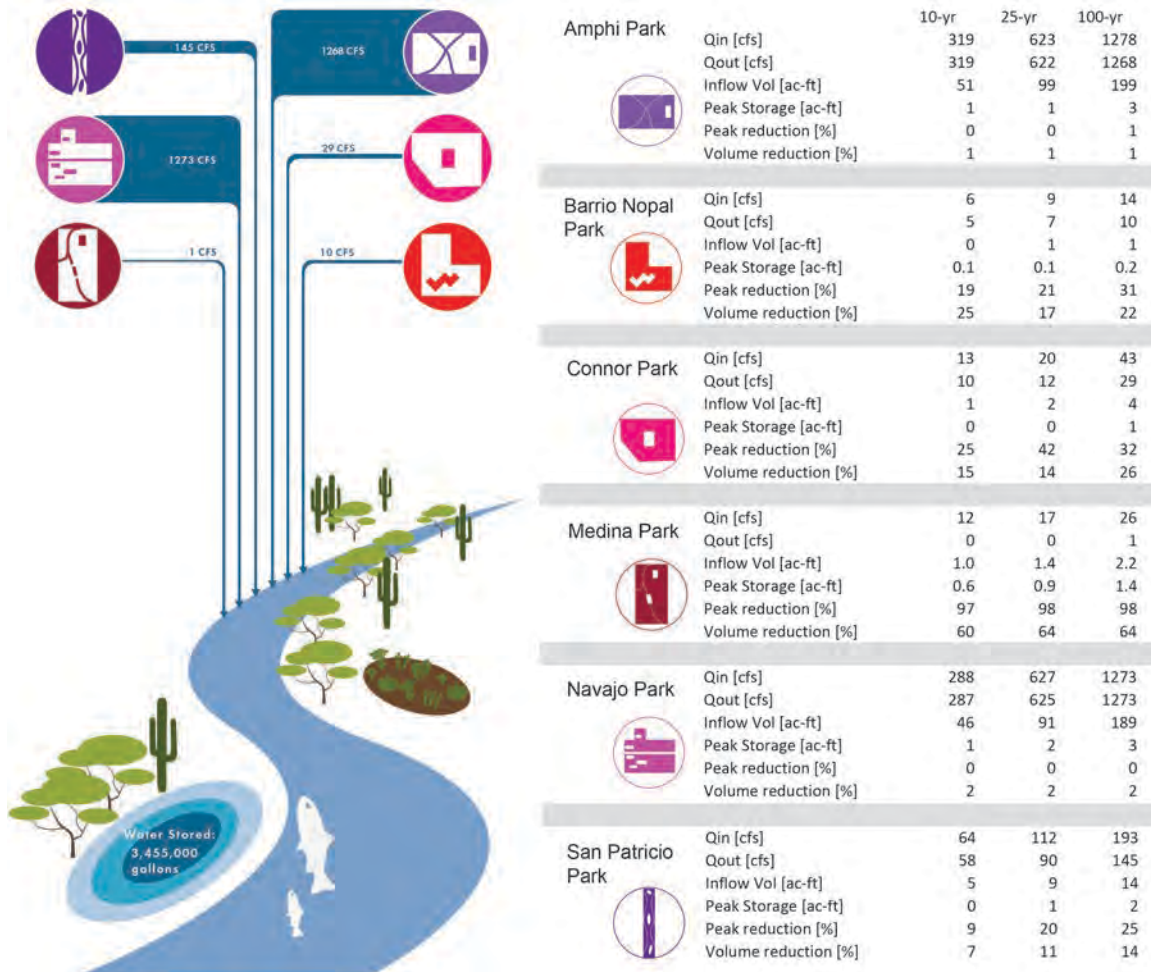
The six design teams also completed multiple community engagement activities to understand and prioritize local needs and desires for the parks. Design teams were each required to follow the same sequence of community engagement meetings and activities. This sequence ensured communication across all levels of existing community organizations. First, design teams held a meeting with the local Ward office to gain neighborhood context and identify community associations and members to contact. Next, design teams scheduled a meeting(s) with identified neighborhood association(s) to present their initial design ideas and clarify community need(s). Third, design teams conducted an activity (e.g. comment box in the park, survey with local businesses, mapping exercise with community leaders) to gain measurable data and further detail and context on identified needs. Design teams responded to stated community needs through context-specific green infrastructure that provided localized and network benefits including flood reduction, shaded pedestrian areas, and place-specific social areas. Lastly, a large community presentation of the final designs was held at a local Ward office at the end of the semester. City and County administrators, neighborhood representatives, and engaged citizens attended.

### 3.2. Hydrological and Hydraulic Modeling of Municipal Parks

As a part of this public-academic partnership, Pima County Flood Control sponsored the studio and completed hydrological modeling across the six parks (FIGURE 1 and 2). This modeling was completed with Flo-2D, a fluid dynamics software that combines hydrology and hydraulics to model flooding conditions. Student were provided with three iterative flood analyses to inform their designs: a baseline case for their site, flow reduction and storage capacities for their mid-term design, and flow reduction and storage capacities for their final design. Design teams were able to improve their park designs iteratively, resulting in reduced peak flows and maximized stormwater storage. The project used an evidence-based design approach and community engagement processes.

### 4.0. RESULTS AND APPLICATION

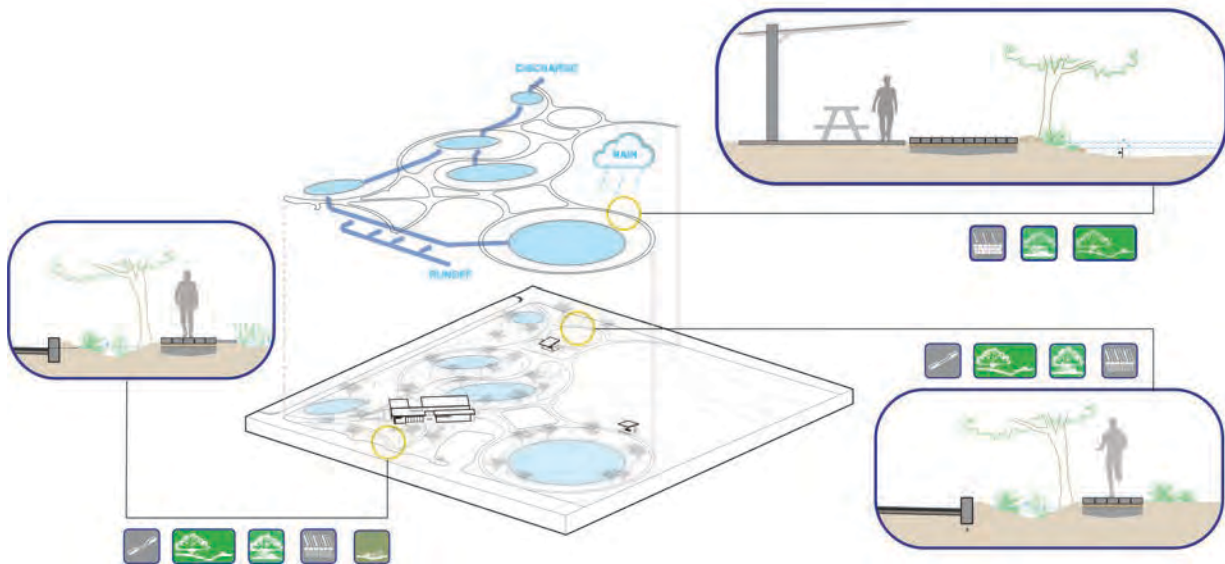
Overall, the six park designs provided a network of an additional 3.5 million gallons of distributed flood water storage to the city (FIGURE 2). Projects with the largest areas and highest existing flooding volumes (e.g. typologies of large park or strip mall conversion) were most effective at contributing to overall watershed flood mitigation. Smaller neighborhood interventions (e.g. typologies of neighborhood park and church yard) offered important, localized mitigation, but contributed minimally to alleviating wider watershed flooding issues. Performative landscape results for each typology are discussed in this section. Additionally, community engagement techniques and outcomes are outlined particular to each site and neighborhood group.



**Figure 2:** Performance results from Flo2D modeling of six park network Source: (Jacob Prietto, Yinan Zhang, Author and ARCH 451b/510f studio and Author 2019)

#### 4.1. Project 1 / Barrio Nopal Park / Large Recreation Park Typology

The Barrio Nopal Park is situated in South Tucson in a low-income, traditionally Hispanic neighborhood across from a public middle school. Early engagement with the Ward office and then the Barrio Nopal Neighborhood Association led students to augment a splashpad that was specified in the Proposition 407 bond for this park with more specific community needs for fitness and spaces for community gathering. This large park typology design mitigated urban flooding through the addition of three large and two medium basins and a channel of bioswales lining the north and west edges of the park (FIGURE 3). These basins and bioswales rejuvenated existing wildlife habitat and added a multiloop fitness path for the neighborhood. Expanded recreation space for after school programs at the neighboring school was provided. A modest community center was added per request from the neighborhood. Other large parks can learn from the multiple basin design forming a multiloop fitness amenity. Overall, the design was well received by the neighborhood and resulted in a 22% peak volume reduction for a 100-year storm while providing 456,191 gallons (1.4 acre-feet) of storage (FIGURE 2 and 5). The Barrio Nopal Park is slated to be constructed in the next year.



**Figure 3:** Barrio Nopal Park master plan for flood mitigation with green infrastructure. Source: (ARCH 451b/510f studio and Author 2019)

#### 4.2. Project 2 / Medina Park / Abandoned Lot Conversion Typology

Medina Park converted an abandoned dirt lot and food truck spot into a community park and eating area. Engagement with Ward 1 at the start of the project, then later conversations and surveys with the food truck owners that used the lot and the adjacent neighborhood church, led students to improved amenities for these businesses, customers, and citizens. Pedestrian and bicycle paths were provided with shade through microbasins lining the street that reduce chronic street flooding (FIGURE 4). More substantial flood reduction was accomplished with two large and two medium basins. A public playground was added per community request. Additional area for the adjacent church’s community garden was supplied. Finally, the design builds on an existing food truck business in the lot and added amenities including open air bathrooms and sinks, permeable paving and covered stalls, and eating areas. This abandon lot conversion provided a typology of reducing flooding while strengthening local businesses. Overall, the design resulted in a 64% peak volume reduction for a 100-year storm while providing 65,170 gallons (0.2 acre-feet) of storage (FIGURE 2 and 5).



**Figure 4:** Medina Park / Abandoned Lot Conversion Master Plan. Source: (ARCH 451b/510f studio and Author 2019)

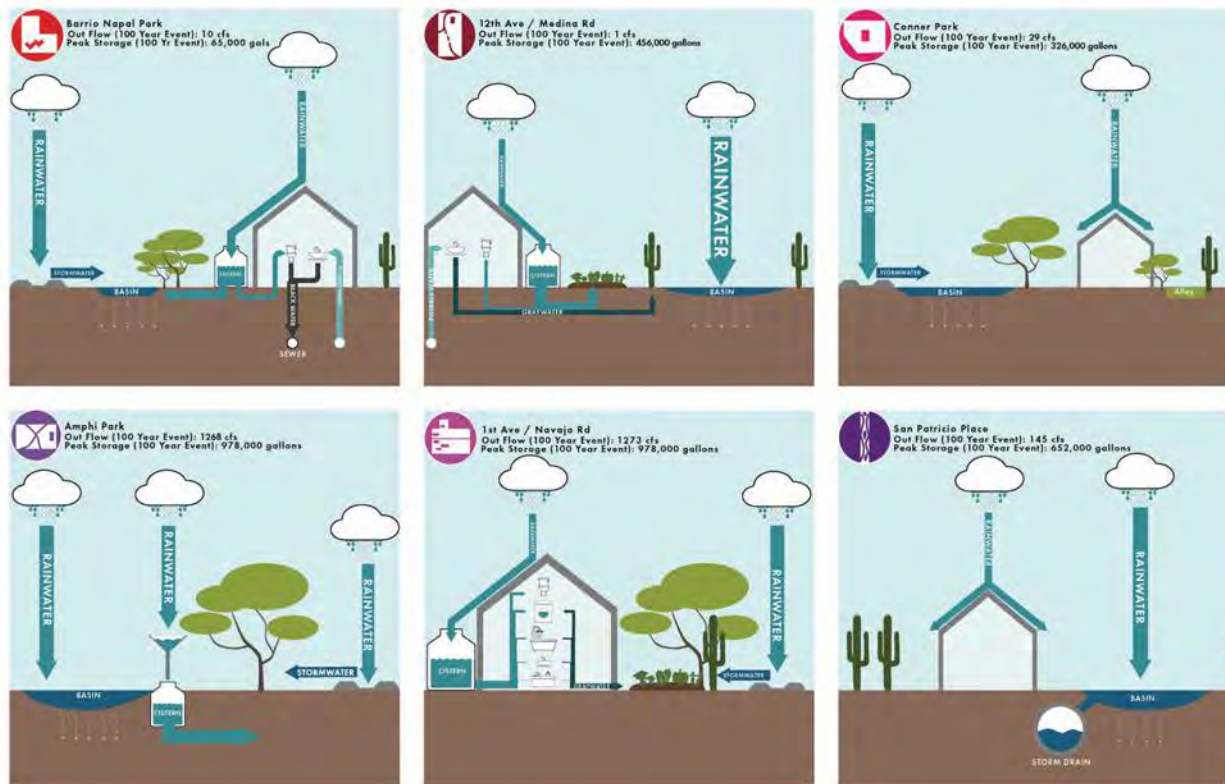


### 4.3. Project 3 / Connor Park / Neighborhood Park Typology

Connor Park is an existing, underutilized neighborhood park with a wash running along one side. Students first met with the local Ward office and then with the neighborhood association. The design team decided to gain feedback on possible park designs and needs through a comment box stationed in the park with double sided surveys that asked citizens to rank the most needed amenities and then draw the placement of these amenities on a park map. Through this community engagement, the design team learned that adjacent neighborhoods no longer favor the baseball diamond. A multiuse field and new playground for multiple ages were provided as replacements. The multiuse field was sunken into the ground and used as an overflow for the wash during peak flow conditions, mitigating substantial neighborhood flooding. Other neighborhood park typologies that seek to reduce neighborhood flooding can emulate the multiuse field that doubles as a large basin. The design resulted in a 26% peak volume reduction for a 100-year storm while providing 325,851 gallons (1 acre-feet) of storage (FIGURE 2 and 5). This park is slated to be renovated in the next year.

### 4.4. Project 4 / Navajo Park / Strip Mall Conversion Typology

The site for Navajo Park is an existing blighted strip mall that has been unused for many years. After conversations with the local neighborhoods, adjacent businesses, and Ward office, the design team decided to remove the strip mall structures and provide a new needed park in their place. The neighborhood had been promised a park from the City for several years, as it was one of a few areas that did not have a local green space. The new park was designed with a network of six basins that took large amounts of flooding from the adjacent Navajo wash. Current pedestrian and bicycle accidents and fatalities were addressed by converting the edge of the wash into a multilane protected bicycle and pedestrian route. The strip mall is a common typology in Tucson and this design provided one example of a successful park conversion to reduce neighborhood flooding. The conversion translated into one of the largest storage volumes of the project for a 100-year storm with 977,553 gallons (3 acre-feet) of storage (FIGURE 2 and 5).



**Figure 5:** Diagrams of water types and flows of the six park performative landscape network. Source: (ARCH 451b/510f studio and Author 2019)

#### **4.5. Project 5 / Amphi Park / Church Yard Typology**

Amphi Park is a design for a large, fenced, private, church yard frequented by a significant homeless population. This design team conducted the most community engagement meetings of any of the six parks to complete this design. In addition to the Ward office, the design team met multiple times with the church that owned the land, the neighborhood association, and the local homeless resource center that supported and bordered the park. Following the wishes of the church and the neighborhood homeless resource center, the students were challenged to keep the existing fence while enlivening the area as a park and expanding the user groups frequenting the park. The design included additional programming for events and small social gatherings while recessing these spaces in the ground to act as shallow basins to reduce surrounding flooding. The existing chain-link fence surrounding the park was replaced with a curving sequence of posts with native cacti below that provided a more aesthetic and naturalistic barrier. Church yards wishing to convert to parks can borrow the basin event space designs from this typology. Overall, the design resulted in a 1% peak volume reduction for a 100-year storm while providing a significant 977,553 gallons (3 acre-feet) of storage. Although the peak volume reduction was relatively small, this site had the most substantial existing flooding (FIGURE 2 and 5).

#### **4.6. Project 6 / San Patricio Park / Industrial Conversion Typology**

San Patricio is a long, narrow site converted into a park to reduce neighborhood and street flooding. Students met with the local Ward office and then engaged with community members at the monthly Flowing Wells Neighborhood Association meeting. Students had members complete a survey of community needs and potential park amenities. A series of large covered basins provide formal and informal social gathering spaces of various sizes. These basins are surrounded by a multiloop walking path for health benefits to the surrounding community. By changing the impervious surfaces to biofiltration basins and permeable walkways, this park minimizes runoff. The design resulted in a 25% peak volume reduction for a 100-year storm while providing 651,702 gallons (2 acre-feet) of storage (FIGURE 2 and 5). This park design was well received by the neighborhood association, but acquisition of the land is still under negotiation.

### **5.0 CONCLUSION**

Across six urban park typologies, this paper concludes that early collaboration between architects, municipalities, and citizens can ensure infrastructural investments are optimized to achieve multiple purposes for the greatest value to the city and benefit to the local community. Habitat restoration, heat island mitigation, pedestrian and bicycle shade and protection, and expanded community social spaces are some of the additional benefits realized particular to each typology. Students followed a community engagement sequence that included meeting with the local Ward office, then the neighborhood association(s), and finally additional stakeholders like adjacent businesses or social service providers. This sequence ensured communication across all levels of local community organizations. As Tucson moves forward with the Proposition 407: Parks and Connections Bond and the new Green Infrastructure Fee, the design lessons learned from the six typologies can be replicated in other areas for optimal benefit throughout the city.

Modeling and monitoring the technical performance of green infrastructure in these landscapes is critical to expanding flood mitigation benefits. Large parks, neighborhood parks, church yards, abandoned lot conversions, industrial conversions, and strip mall conversions form a network of new and existing parks throughout the city. With minimal increase to the budgets of these new and existing parks, much needed flood mitigation can be expanded and maintained through the iterative performance modeling and monitoring of these spaces.

This paper presents a replicable model for architectural academia to join with local communities and government staffs to provide practical solutions to urban water challenges through a performative landscape approach for the design of the urban park system. The six park designs created a network of performative landscapes able to deliver decentralized flood mitigation throughout the city, totaling 3.5 million gallons of distributed flood water storage. The City is moving forward with several of the larger park designs completed by this research and design project through scheduled bond funding with support from a new green infrastructure fee.

### **ACKNOWLEDGEMENTS**

The students of Architecture 451b/510f included undergraduate Bachelor of Architecture Students and Master of Architecture Students. Thanks to all the students for their hard work and creative energies in the park designs and community engagement activities: Kittitash Chaikunpon, Paloma Colacion, Xiaoang Li, Humberto Lopez, Liz Madsen, Andrea Norton, Caitlyn Richard, Juan Salvo, Kyle Schuman, Tianzhi Sun, Jessica Tanner, Manuel Vazquez.



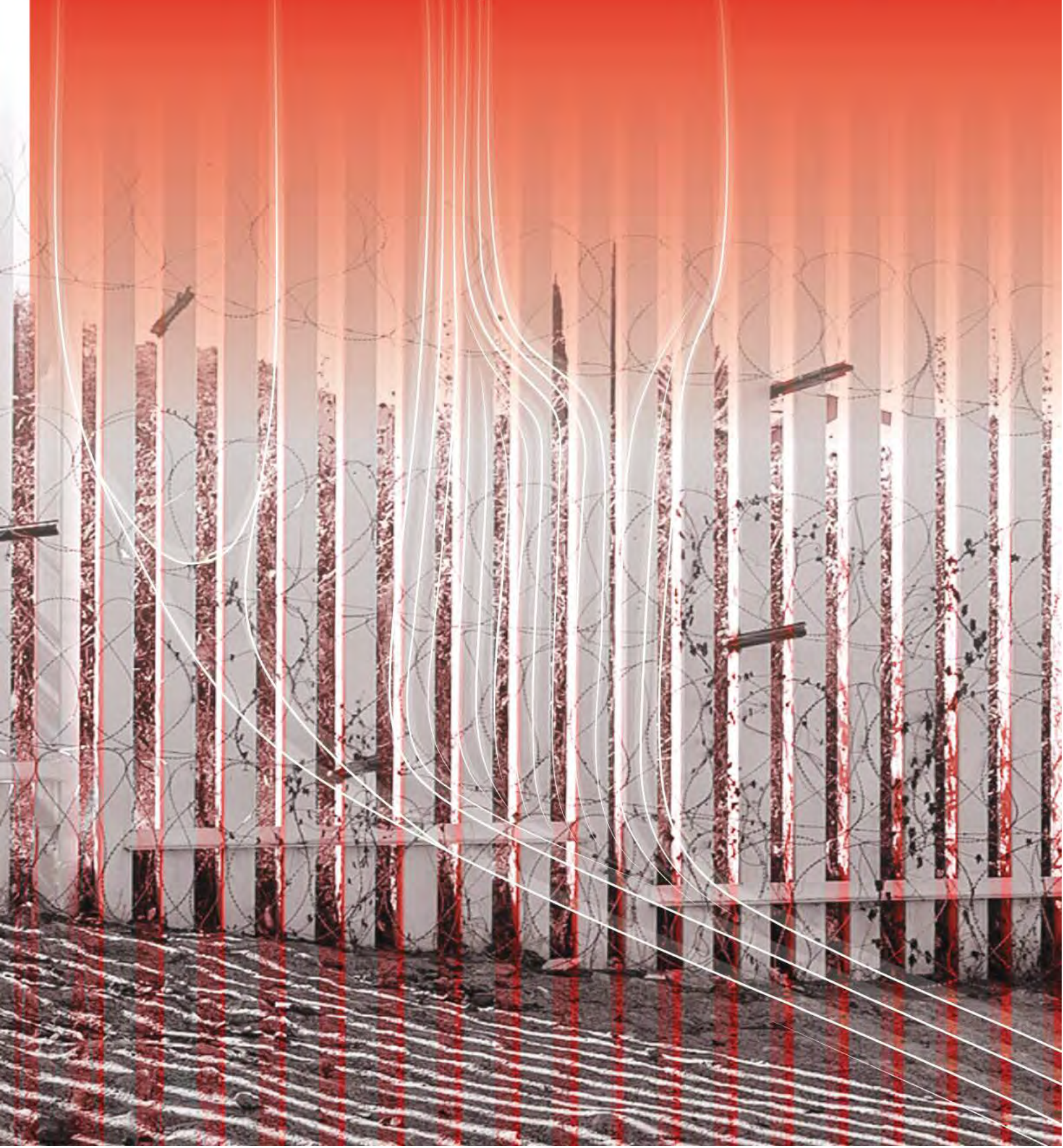
## REFERENCES

- Bakkensen, L. and R. Johnson. 2017. *The Economic Impacts of Extreme Weather: Tucson and Southern Arizona's Current Risks and Future Opportunities*. Making Action Possible for Southern Arizona.
- Bell, L. M. 2018. *Examining the User Experience in Climate-Adaptive Policies: Tucson Arizona's Residential Gray Water Recycling*. Master's thesis, Cornell University.
- Belizario, P., Scalize, P., & Albuquerque, A. 2016. *Heavy metal removal in a detention basin for road runoff*. Open Engineering, 1 (open-issue).
- Ely, M., & Pitman, S. 2014. *Green Infrastructure Life Support For human habitats. The compelling evidence for incorporating nature into urban environments*. Green Infrastructure Evidence Base 2014.
- Environmental Protection Agency. 2020. *What is Green Infrastructure?* Accessed 19 May 2020. <https://www.epa.gov/green-infrastructure/what-green-infrastructure>
- Feng, Youcan, and Steven Burian. 2016. *Improving Evapotranspiration Mechanisms in the U.S. Environmental Protection Agency's Storm Water Management Model*. Journal of Hydrologic Engineering 21(10):06016007. doi: 10.1061/(ASCE)HE.1943-5584.0001419.
- Lucas, W. C., & Sample, D. J. 2015. *Reducing combined sewer overflows by using outlet controls for Green Stormwater Infrastructure: Case study in Richmond, Virginia*. Journal of Hydrology, 520, 473-488.
- Lucke, T., & Nichols, P. W. 2015. *The pollution removal and stormwater reduction performance of street-side bioretention basins after ten years in operation*. Science of the Total Environment, 536, 784-792.
- Meiklejohn, Katie, Rob Ament, and Gary Tabor. 2009. *Habitat corridors & landscape connectivity: clarifying the terminology*. Center for large landscape conservation.
- Roman, Lara A., Jason P. Fristensky, Theodore S. Eisenman, Eric J. Greenfield, Robert E. Lundgren, Chloe E. Cerwinka, David A. Hewitt, and Caitlin C. Welsh. 2017. *Growing Canopy on a College Campus: Understanding Urban Forest Change through Archival Records and Aerial Photography*. Environmental Management 60(6):1042-61. doi: 10.1007/s00267-017-0934-0.
- Roy, A. H., Wenger, S. J., Fletcher, T. D., Walsh, C. J., Ladson, A. R., Shuster, W. D., & Brown, R. R. 2008. *Impediments and solutions to sustainable, watershed-scale urban stormwater management: lessons from Australia and the United States*. Environmental management, 42(2), 344-359.
- Zhang, Q. 2019. *Spatial Sustainability Assessment of Green Stormwater Infrastructure for Surface Transportation Planning, Phase III*. Funded by Office of the Assistant Secretary for Research and Technology, University Transportation Centers Program.
- Zuniga-Teran, Adriana A., Chad Staddon, Laura de Vito, Andrea K. Gerlak, Sarah Ward, Yolandi Schoeman, Aimee Hart, and Giles Booth. 2019. *Challenges of Mainstreaming Green Infrastructure in Built Environment Professions*. Journal of Environmental Planning and Management 1-23. doi: 10.1080/09640568.2019.1605890.





# ORGANIZATIONAL PERFORMANCES





# Situating Access and Breaking Boundaries: Holistic Responsivity as a Provocation

Bushra Hashim<sup>1</sup>, Dr. Brian R. Sinclair<sup>1</sup>

<sup>1</sup>University of Calgary, Calgary, Alberta, Canada

**ABSTRACT:** Contemporary society, including architecture, urbanism, and city planning, stands at a vital juncture. Calls for heightened equity amidst growing diversity offer an unprecedented opportunity to reconsider design thinking. A part of this equation pertains to how users address and operate within the built environment moving past mobility, to include people with intellectual disabilities (ID). Intellectual disabilities have been understood historically with the manifestation of intellectual ableism within the built environment. Current design research and practice under-represent intellectual disabilities, affirming the need to innovate architectural solutions that encourage inclusion and participation. *Holistic Responsivity*, a term coined by the authors, conveys this notion that designers shoulder serious and imminent responsibility for creating built environments responsive to users' wide-ranging abilities. It is proposed as a provocation of the status quo, an expansion in the catchment in critique of current universal design's one-size-fits-all approach to accessibility. Informed by neuroarchitecture, agile architecture, and cybernetics [NAAC], Holistic Responsivity provides a conceptual framework applied to design processes. This research consolidates through case studies, primary data collection via three survey methods, and action-based research. Collected data will, downstream, be qualitatively analyzed through content, narrative, and discourse analysis to understand the experiences of people with cognitive disabilities and perceived barriers in the built environment, and the perception of disability within architectural practice and education. This methodology unites primary and secondary research towards experiential equity through logical argumentation, finally proposing new design guidelines that are more responsive, resilient, and responsible.

**KEYWORDS:** intellectual disabilities, holistic Responsivity, neuroarchitecture, agile architecture, design, systems thinking

## INTRODUCTION

The year 2020 marked three decades of the Americans with Disabilities Act (ADA) compliant design, a necessary step to include a large disabled community that are equal users of our spaces. However, the ADA's manifestation within the built environment has failed to consider the whole cohort of users whose realities are shaped by cognitive and intellectual disabilities, often being limited to physical disabilities (PD) under the guise of universal design. Universal Design [UD] was suggested by architects as a more cost-effective way of approaching the ADA's requirements of barrier-free design, making it a proactive decision rather than an expensive afterthought (Ralabate 2011). While UD promotes access for individuals with disabilities, it also benefits others and theoretically should not be solely focusing on accessibility issues. The primary issue then becomes this idea of 'designing for all but designed for none.' For example, an accessibility ramp for mobility or proprioceptive disabilities also facilitates the movement of non-disabled people with strollers or carts. Architects' conceptions of the disabled body have cast it as preformed, fixed, and whose needs are known and objectively quantifiable through the ADA and Accessible Design Standards [ADS]. This understanding leads to architects' design processes and practices as producing 'standard-fit' design that is decontextualized, one-dimensional, and caters to no one in particular (Hall and Imrie 1999). Furthermore, design practice is constrained by the economics of the building process towards the production of "fixed spaces, not fluid ones, in a predictable and permanent relationship to each other" (Knox 1987, 364).

What UD theoretically claims and practically applies have manifested differently within the built environment. Although promising, UD cannot meet different groups' individual needs in its quest towards inclusivity. This inadequacy is seen in numerous studies conducted assessing ID access to the built environment. These studies collectively agreed on the relative exclusion of people with ID versus those with PD. Rationales for this exclusion and limitations in design solutions are attributed to varying reasons: the lack of a coherent set of guidelines or body of research for people with ID (Tuckett et al. 2004; Castell 2012), perception of the ADA as costly and inhibiting creativity (Gray, Gould, and Bickenback 2003), and lack of the ADA's consideration of neuroarchitecture and the impact of the built environment on the central nervous system (Gillen 2015); design solutions were limited to wayfinding (Castell 2012), as seen in three studies related to ID (Salmi 2007; P. Salmi et al. 2004; Office of the Deputy Prime Minister 2006), and devaluing the importance of social inclusion within accommodation (McConkey et al. 2019; Butterworth 2000). In tandem with marginalization through existing political and social structures, today's static urban and architectural environments continue to reinforce the physical and psychosocial isolation associated with said disabilities (Butterworth 2000; Curtis & Rees Jones 1998). These same structures are reflected in the built environment resulting in their lack of participation in the built

environment (Gray et al. 2003; Raczka et al., 2020; Kamstra et al., 2017), the lack of reflection and replication of meaningful social relations (Curtis & Rees Jones 1998; McConkey et al. 2019; Sheerin 2020), and deterioration of mental health (Halpem, 1995; Butterworth 2000). These all exist in a greater realm where they are crucial components of human wellbeing (Butterworth 2000).

Shifting from the practical to the theoretical sphere, ethical questions arise about vulnerable groups like people with ID and the fundamental principle of non-maleficence (Northway 2014). A quick survey of the Journal of Intellectual Disabilities resulted in more than 3000 papers exploring the term 'inclusion,' seeking to understand and mitigate the exclusion of people with ID experience (Sheerin 2020). While concerted efforts are made by organizations like the International Association for the Scientific Study of Intellectual and Developmental Disabilities (IASSID) (Schalock et al. 2002) and the International Summit on Intellectual Disability (Watchman et al. 2019) to develop core principles within the research field, the views, voices and experiences of people with ID remain unheard. Defined as 'shoehorning' (Sinclair 2019), this population is thus forced into built environments with the requisite need to adapt, adjust, alter, and surrender. Such situations indicate a design apartheid akin to an infringement of disabled people's civil liberties (Hall and Imrie 1999). Given the current climate of the pandemic, challenges are faced by people of all abilities. However, those with intellectual disabilities have been exponentially proliferated (Sheerin 2020) given their systemic marginalization coupled with disablist attitudes, values, and practices of architects and design processes.

## 1.0 RESEARCH QUESTIONS

The present research, across multiple phases, explores several key issues (both broad & deep). This paper seeks to put forward an interdisciplinary theoretical framework through which designing for neurodiversity can begin to be approached practically via the proposed methodology.

1. How can architects begin to build a knowledge base around the environmental needs of people with intellectual disabilities?
2. How can current environments be more responsive to the individual needs of people with intellectual disabilities?
3. How can architecture influence automatic behaviours to allow people with intellectual disabilities to partake in the built environment in a more experientially equitable way?
4. How can architects design buildings and public spaces that promote the dignity, inclusion, and participation of people with intellectual disabilities?
5. How can design processes be informed to bridge the gap between Holistic Responsivity and its NAAC [neuroarchitecture, agile architecture, cybernetics] research approach, and current arguably exclusionary architectural practices?

## 2.0 CONCEPTUAL FRAMEWORK

### 2.1 Holistic Responsivity

Defined by Bushra Hashim + Dr. Brian R. Sinclair, *Holistic Responsivity* in the built environment considers the complex interplay of forces and factors that impinge upon a user within spaces/places. It acknowledges the diversity of user sensitivities, predispositions, and reactions to parameters of built and natural environments while also calling for the designer's ethical action in constructing environments that can better adjust to meet changing user needs reflexively. Holistic Responsivity's conceptual framework is informed by three interdisciplinary theoretical approaches: neuroarchitecture, agile architecture, and cybernetics [NAAC]. Elaborated below, the three tactics' historical, theoretical, technological, and social interrelationships have reconceptualized after years of absence. They are necessarily essential to consider and mobilize at a time of heightened uncertainty. It is fundamental that architectural theory and practice, through the lens of systems thinking, understand human behaviour, perception, emotions, facilitate responsive environments in an era of smart cities, and embrace artificial intelligence, virtual reality, computer simulations, and other advanced communications. Holistically Responsive Design's end goal is to provide experientially equitable spaces and places that strive to enable all users regardless of their unique abilities and specific circumstances.

### 2.2 NAAC: Neuroarchitecture, Agile Architecture, and Cybernetics

#### 2.2.1 Neuroarchitecture

The built environment has a direct impact on the human brain (Andréa de Paiva 2018). Understanding the way information is consumed and processed by people with ID is necessary to understand their environmental needs. According to neuroscience, the ability to process information consciously is less than 1% of unconscious processing; thus, environmental information, such as image, sound, and design, is unconsciously retained by the brain in a way that alters behaviour subconsciously (Andréa de Paiva 2018). Architecture can thus deploy to increase adaptive behaviour and provide more experientially equitable spaces. The field that has perhaps most profoundly studied the psychological and physiological effects of the natural, and by extension, the built environment's role in human functioning is environmental psychology. Studies have found that humans are aesthetically attracted to natural contents

and particular landscape configurations (Joye 2007). In the words of Ulrich, "...virtually no meaningful thoughts, actions, or environmental encounters occur without affect (Ittelson 1973; Izard 1977; Zajonc 1980)...an affective state is an important indicator of the nature and significance of a person's ongoing interaction with the environment" (Lazarus, Kanner, and Folkman 1980). Similarly, interior design has also recognized and acted upon the relationship between psychological wellbeing and a person's environment, focusing on designing for people with intellectual disabilities (Reilly 2000; Karol and Smith 2019; Tauke and Smith 2020). Thus, environmental psychology and interior design, amongst others, are supplemental fields of inquiry that will prove pivotal to developing the comprehensive theory of Holistic Responsivity.

### 2.2.2 Agile Architecture

Advances in science, methodologies, theories, and technologies have enabled the potential to heighten our quality of life through agile and responsive environments (Sinclair 2019). Sinclair explores this branch of architecture extensively to address the concept he called 'shoehorning,' wherein users are forced to adapt to the static environments that inform the current status quo. Contrarily, agile architecture, integrating aspects of durability, flexibility, and responsibility, pursues:

...a measure which is more independent, responsive and holistic; a measure that integrates aspects of durability, flexibility and sustainability; a measure that unifies the scattered facets of contemporary sustainable designs; a measure that introduces all layers of physical, social, environmental and financial factors in the form of continuously evolving and dynamic framework; a measure better interlacing design phases to construction, operation, occupancy, disassembly and reuse. (Sinclair 2019; Imam and Sinclair 2012, 2)

Agility postulates that designers need to be better at working with uncertainty, shifting away from the status quo -- namely, seeing the built environment as an artifact, fixed and determinate --to seeing it as a living system itself, responsive and dynamic. As an example, mutating spaces responsive to shifting needs; this demands interdisciplinarity in its execution, learning from lessons from the past, understanding the present's needs, and conjuring predictive ability to anticipate the future (Imam and Sinclair 2012). This predictive ability is where cybernetics establishes itself as the unifying anchor between neuroscience and agility.

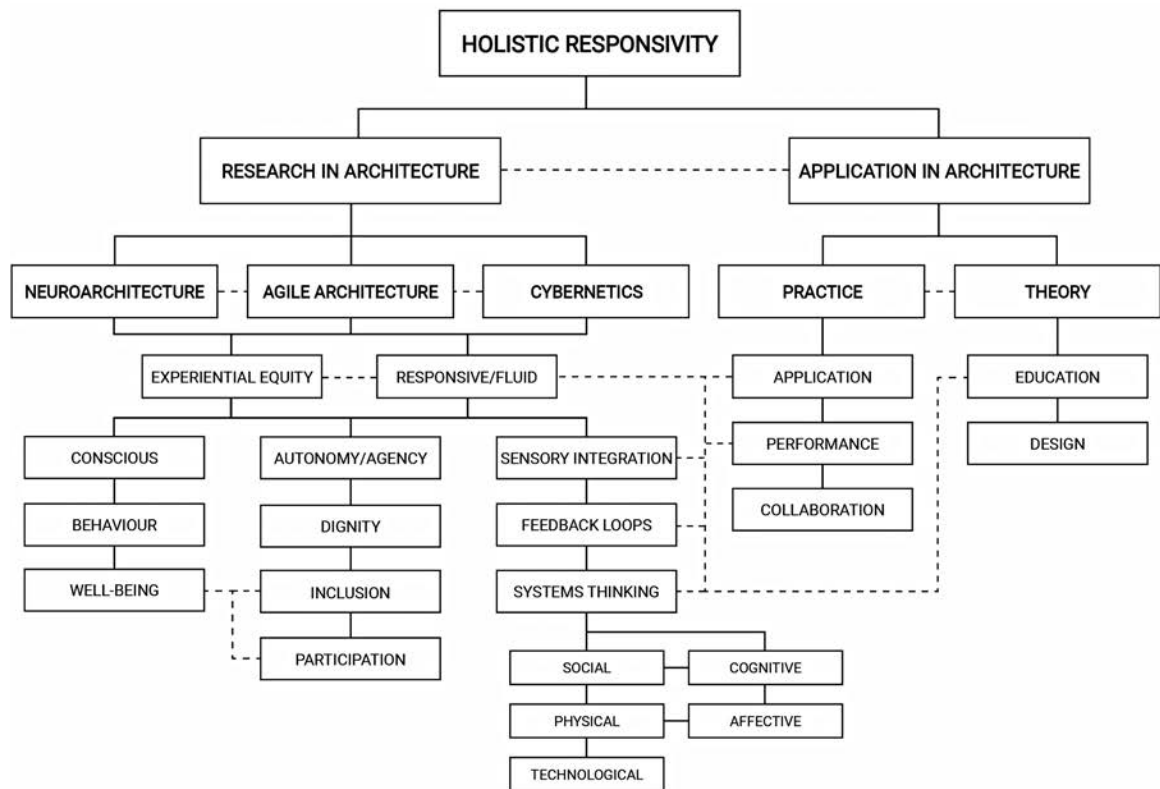
### 2.2.3 Cybernetics

Cybernetics is complex and transdisciplinary, permeating and cross-referencing the historically disparate fields of art and science. The discipline is contingent on systems thinking, based on regulation, control, adjustment, and purpose, filtered through feedback loops, or circular causation reasoning, that institute a way of thinking that allows for self-organization (Pask 1969; Dubberly and Pagaro 2015; Ackoff 1974). Pioneered by Gordon Pask with his Theory of Conversations, cybernetics explore how humans and machines learn (Pask 1969). To this day, it challenges the conventions of architectural design processes of production and consumption that alienate design professions from one another (Dubberly and Pagaro 2015). Gestalt psychology postulates that the whole is greater than the sum of the parts (Sinclair 2013); it is the interplay between the parts of a system that drives performance rather than the human or machine's individual's behaviour functions (Ackoff 1974; Sinclair 2017). Examples of such feedback loops exist widely in fine art, notably in the work of Roy Ascott and other artists associated with the British Ealing College of Art in the 1960s. Embodied through his *Change Paintings*, founded on cybernetics' concepts of process, behaviour, and systems, Ascott envisioned his audience could more actively participate in the creative process according to their subjective aesthetic sensibilities at that moment (Shanken 2002). In conclusion, Ascott drew on cybernetics to theorize a model of how art could transform culture:

As feedback between persons increases and communications become more rapid and precise, so the creative process no longer culminates in the *artwork*, but extends beyond it deep into the life of each individual. Art is then determined not by the creativity of the artist alone, but by the creative behaviour that his work induces in the spectator, and in society at large...The art of our time tends towards the development of a *cybernetic vision*, in which feedback, dialogue and involvement in some creative interplay at deep levels of experience are paramount...(Ascott 1968, 106).

Rooted in neurobiology, cybernetics has helped develop architectural computer-aided design and continues to inform computational design today. Supporting the agenda of agile architecture, the cybernetic theory of architecture postulates that architecture can no longer be static but needs to implement design that inherently embodies rules of evolution, through self-governed feedback loops, in order to ensure healthy and responsible outcomes (Dubberly and Pagaro 2015; Ackoff 1974; Sinclair 2017). It seeks to create responsive spaces wherein the environment is no longer the subconscious controller of its inhabitants but preferably one they consciously control.





**Figure 1:** Conceptual Framework

### 2.3 Practice + education

Considering both practice and education, the profession is ill-equipped to address the environmental needs of people with ID; few and ineffective design solutions have been considered for this group (Hall and Imrie 1999). The sources of disabled people's exclusion from many facets of the built environment are linked, in part, to the practices and values of professionals involved in design and construction processes. With design theory tending to concentrate on the technocratic and technological, reducing questions of access and form to the subject's functional aspects, the social, cultural, spiritual, and humans facets of being and dwelling are all too often neglected (Sinclair 2014). No longer in an era of mass industrialization, the profession must evolve in the face of growing conflict, tension, and unclear values propositions. Critical facets of practical and educational shifts include "understanding human behaviour, developing business skills, designing responsive environments, and invoking research" (Sinclair 2014, 5). The mixed-methods research is thus strategically delineated to inform both architectural practice and education in the future.

### 2.4 Theoretical interrelationships

The relations and building blocks that guide analysis and evaluation are represented graphically within Figure 1. Interdisciplinary theoretical knowledge will allow architects to educate themselves on the brain's working patterns and how space affects cerebral functions. For example, "schools can be designed in a way to improve cognition, learning and memorization; hospital buildings can help improving recovery; workspaces can improve performance, creativity, and collaboration." (Andréa de Paiva 2018, 137). Since its inception in the 1970s, the standard for designing sensory environments has been the Snoezelen Room, a space that "invokes environmental manipulation to affect internal change in the [user], decreasing maladaptive behaviour, reducing stress, and producing more adaptive behaviour" (Shapiro et al. 1997, 141). Despite promising starts, little to no progress has since been made. Technological advancements in the last few decades have allowed for the development of research (Andréa de Paiva 2018), enabling the imminent need to rectify disabling environmental hypersensitivity and sensory processing disorders associated with the neurotypical architecture of today (Gillen 2015). The relationship between research and application is a feedback loop that necessitates implementation to inform both theory and performance, and enable the evaluation and refinement of their manifestations within the built environment. Systems Thinking, and its social, physical, cognitive, affective, and technological dimensions, is the theoretical link that allows for the evaluation and reevaluation of applied Holistic Responsivity, both in practice and education. The sub-relationship between NAAC is a major building block towards Holistic Responsivity's conceptual development, with experiential equity and responsive environments being the critical links to practical application and performance. Wellbeing is evaluated concerning inclusion and participation within the built environment to allow for agency and dignified living of this often-forgotten cohort of our society. Finally, weaving the agendas of NAAC together in practice and education, the unifying theory of Holistic Responsivity informs a logic for perceiving architecture as an interdisciplinary system. Such a system is achieved by engaging computational thinking

through the lens of development, communication, and control, and proposing the revolution of current design processes to integrate those which may predict future behavioural and environmental evolutions immediately. This is especially important in today's enmeshment of political, cultural, social, and environmental spheres as wicked problems that are daunting to approach, let alone solve. Transdisciplinarity, collaboration, and performance have become key themes that need to inform the broader system of environmental design within which this research nests. Developments and directions hold promise to the present authors.

### 3.0 RESEARCH METHODOLOGY

#### 3.1 Overall approach + ethics

A mixed-methods approach is mobilized after further research into work that addressed similar research objectives (Maleki and Bayzidi 2017; Hall and Imrie 1999). Most notably, a study conducted in Great Britain, which after the administration of their mixed-methods approach to people with ID, sought to explicitly describe the difficulties encountered during recruitment and fieldwork and how the researchers approached overcoming such hurdles (Corby and Sweeney 2019). When determining which data collection and analysis methods to use, three studies, all of which explored different avenues of research within the realm of ID, were prioritized. In tandem with Corby and Sweeney's mixed-methods approach through participatory research, the application of neuroscience to architecture and disabling design in the built environment were key precedents. Corby and Sweeney recommended it necessary to be aware of the most effective ways of potential participants familiarizing themselves with the study, including approaching the correct people with relevant experience on the research topics exploring intellectual disabilities and the built environment (Corby and Sweeney 2019).

The primary consideration in terms of comparability of the three studies is the precedence given to COVID-19's restrictions, limiting how data is collected to secondary rather than primary interactions. As the present proposal seeks to research with a vulnerable group, ethics approval will be secured from research services at the host institution after support is obtained from all the stakeholders. It is important to stress that the approach warrants a staged process: contacts are made, relationships are built with the stakeholders within their respective expertise, the purpose and projected processes of the study are explained, and roles are established in tandem with the methodology and ethical considerations. This clarification will enhance the quality of the data collected and ensure that people with ID are optimally understood and addressed throughout the process via the right knowledgebase. The nature of the topic also necessitates empathy, patience, and adequate time allocated for the communication with the stakeholders and proper analysis of the qualitative data collected. Stakeholder input relative to methodology is shown in Figure 2.

#### 4.0 DATA COLLECTION METHODS

The following data collection methods are utilized in the present investigation. This methodology remains flexible due to the unpredictable nature of the pandemic and sensitivities concerning the population group.

1. Case Studies
2. Survey Methods
  - a. Self-Administered Surveys
  - b. Key Informant Interviews
  - c. Focus Group
3. Action-Based Research

##### 4.1 Case studies

Case studies are used for exploratory and developmental research. In the words of Robert K. Yin, "the distinctive need for case study research arises out of the desire to understand complex social phenomena...it allows investigators to focus on a 'case' and retain a holistic and real-world perspective" (Yin 2014, 4). This approach is essential in design research as such inquiries often seek to answer the *how* of design in a particular context or specific user and *why* to apply certain technologies or principles. Multiple-case studies will be examined, as a theoretical proposition is being made. The value of the case studies chosen will thus be contingent upon the degree to which the processes observed can be generalized to other situations.

##### 4.2 Survey methods

Three survey methods will be mobilized to gather primary data respective to the expertise sought from the key stakeholders: self-administered surveys, in the form of open and closed-ended questionnaires, one-on-one key informant interviews that allow for more in-depth primary research data collection, and focus groups further to explore relevant experiences and thoughts from their respective expertise.

###### 4.2.1 Self-administered surveys

Two questionnaires will be distributed via email. The goal is to seek a group of stakeholders that will allow for a better understanding of the sample group, accessed through their primary caregivers and supporters, to get a fuller picture of their lives and their environmental needs that are or are not being met. Like the study undertaken by Hall and Imrie in the British context, the second questionnaire seeks to evaluate architects' understanding of intellectually disabled

people's environmental needs, and analyze their attitudes, values, and practices of design and development processed in the local context. The caregivers will also be approached to collect stories they deem relevant to the understanding and challenges faced by the sample group from the built environment, adding a necessary layer of empathetic understanding for the general audience, including designers. The two types of understanding will inform the design guidelines to be produced through primary research.

#### **4.2.2 Key informant interviews**

Capitalizing on key informant interviews' strength of gaining an initial assessment of an organization's in-depth knowledge, a set of such interviews will be conducted. In-depth knowledge on how to begin approaching main design perspectives will allow for a better understanding of the broad, informative overview of the issues that need further exploration. The interviews will subsequently inform the more in-depth questions posed within the questionnaires and the focus groups.

#### **4.2.3 Focus group[s]**

Informed by the key informant interviews, more extensive questions will be formulated to be delivered and explored through focus groups' discussions. The purpose of these focus groups is to engage in meaningful, open-ended conversation on the needs of people with ID concerning their built environments. Given that a lack of a definitive body of research or guidelines has hindered the practical response to their needs, as illuminated in the literature review, primary research of this sort is both timely and highly valuable to the pursuit of design guidelines. The strategy is to have one firm that has direct theoretical and practical work in making the built environment more accessible for people with ID, and a second firm with no experience in this subject matter but has worked within the local context exploring the idea of intersectionality in public spaces. In other words, the present research will explore knowledge transfer as one aspect of pursuing a more inclusive, holistic, and responsive design. A discussion between the two firms will allow for a more in-depth exploration of architects (writ large) understanding of disabilities, as explored through the questionnaire and Corby and Sweeney's study. This interaction will allow for a better understanding of four key areas: the conceptions of disability and how their needs are incorporated into the design of public spaces; the role of education and application of accessible design inclusive of people with ID; the involvement of user and relevant stakeholder input sought by architects to draw their experiences within the design processes; and lastly, the broader structural challenges and limitations that inhibit or facilitate architects' consideration for the environmental needs of this group, in particular.

#### **4.3 Action-based research**

This research style is used for two primary reasons: its hands-on, participatory character, and its consolidation of empirical research with real projects, allowing for reconsidering current design processes and finding contextual solutions. The method proactively seeks to improve practice by participating, evaluating, and critically reflecting on the design decisions made throughout the process. The exploration of sensory integration, systems thinking, interactivity, inclusion, wellbeing, intersectionality, performance, and collaboration are explored through stakeholders working within the public realm in hopes of achieving experiential equity.

### **5.0 DATA ANALYSIS METHODS**

The development and application of codes, and identification of themes, patterns and relations will be evaluated flexibly through the following approaches: Content Analysis, Narrative Analysis, Interpretive Phenomenological Analysis [IPA], and Comparative Discourse Analysis. This approach capitalizes on the benefits of mixed-methods research and systems thinking by enabling a conversation that threads imminent social, physical, cognitive, and technological needs for the research, alters professional discourse around disabilities, and subsequently improves the design and occupation of the built environment to be holistically responsive. Practically, it disseminates the findings across stakeholder disciplines, consolidating participants' voices and sharing a rich and interconnected analysis of the phenomena, which in turn enhances the validity of the findings.

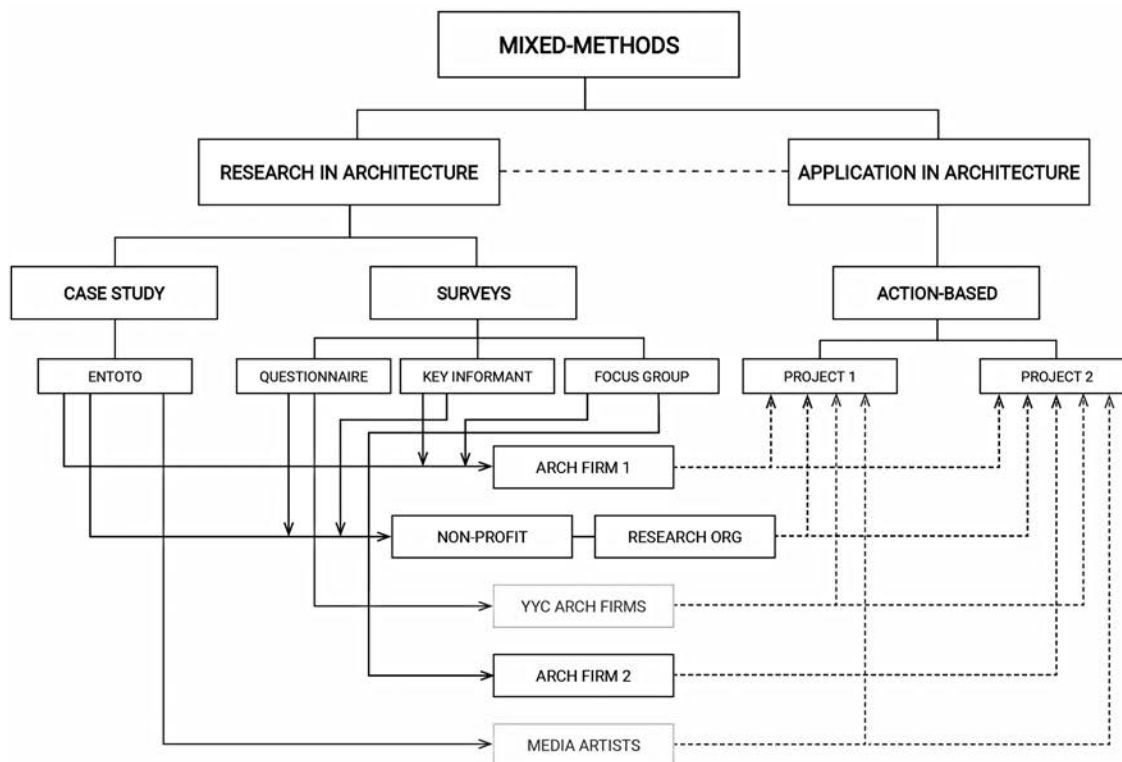


Figure 2: Methodology

**SYNOPSIS**

*"Why fit in when you were born to stand out." Dr. Seuss*

The expected contribution to knowledge lies primarily in bridging the current gap in environmental design research and practice relative to the accessibility of people with intellectual disabilities. "Neurodiversity may be every bit as crucial for the human race as biodiversity is for life in general. Who can say what form of wiring will prove best at any given moment?" (Blume 1998). Acknowledging that design processes and subsequent performances need to be addressed in broader ways to cover crucial cognition encounters and experiences, this body of research acts as a provocation towards design thinking by adding Holistic Responsivity's critical lens to the status quo of built environments. By exploring and applying neuroarchitecture, agile architecture, and cybernetics [NAAC], the authors contend that knowledge and practice be better positioned for a next generation of design that is more responsive, resilient and responsible. Ultimately, this work aims to support and enhance the user's wellbeing, agency, and dignity, informed by systems thinking and circular causal relationships. Finally, the fuller body of investigation and evaluation, in subsequent phases of the research, will take the tangible form of a graphic handbook that documents the findings, the process and implications, and concludes with design guidelines to realize a design profession that is more holistically responsive. Our everyday spaces and places need to ensure all users are more abled, not less disabled.

**REFERENCES**

Ackoff, Russell L. 1974. *Redesigning the Future: Systems Approach to Societal Problems*. California: Wiley.

Andréa de Paiva. 2018. "Neuroscience for Architecture: How Building Design Can Influence Behaviors and Performance." *Journal of Civil Engineering and Architecture* 12 (2): 132–38. <https://doi.org/10.17265/1934-7359/2018.02.007>.

Ascott, Roy. 1968. "The Cybernetic Stance: My Process and Purpose." *Leonardo* 40 (2): 189–97. <https://doi.org/https://doi.org/10.1162/leon.2007.40.2.189>.

Blume, Harvey. 1998. "Neurodiversity: On the Neurological Underpinnings of Geekdom." *The Atlantic*. <https://www.theatlantic.com/magazine/archive/1998/09/neurodiversity/305909/>.

Butterworth, Ian. 2000. "The Relationship between the Built Environment and Wellbeing: A Literature Review." Melbourne.

Castell, L. 2012. "Adapting Building Design to Access by Individuals with Intellectual Disability." *Construction Economics and Building* 8 (1): 11–22. <https://doi.org/10.5130/ajceb.v8i1.2994>.

Corby, Deirdre, and Mary Rose Sweeney. 2019. "Researchers' Experiences and Lessons Learned from Doing Mixed-Methods Research with a Population with Intellectual Disabilities: Insights from the SOPHIE Study." *Journal of Intellectual Disabilities* 23 (2): 250–65. <https://doi.org/10.1177/1744629517747834>.

Curtis, S., and Rees Jones. 1998. "Is There a Place for Geography in the Analysis of Health Inequality?" In *The Sociology of Health Inequalities*, edited by Mel Bartley, David Blane, and George Davey-Smit, 1st ed., 236. Wiley-Blackwell.

Dubberly, Hugh, and Paul Pagaro. 2015. "How Cybernetics Connects Computing, Counterculture, and Design," no. October: 1–12. [https://doi.org/10.1007/978-3-540-92910-9\\_15](https://doi.org/10.1007/978-3-540-92910-9_15).

Gillen, Victoria. 2015. "Access for All! Neuro-Architecture and Equal Enjoyment of Public Facilities." *Disability Studies Quarterly* 35 (3). <https://doi.org/10.18061/dsq.v35i3.4941>.

- Gray, David B., Mary Gould, and Jerome E. Bickenback. 2003. "Environmental Barriers and Disability." *Journal of Architectural and Planning Research* 20 (1).
- Hall, P., and R. Imrie. 1999. "Architectural Practices and Disabling Design in the Built Environment." *Environment and Planning B: Planning and Design* 26 (3): 409–25. <https://doi.org/10.1068/b260409>.
- Halpern, D. 1995. *Mental Health and the Built Environment: More than Bricks and Mortar?* London: Taylor & Francis.
- Imam, Salah, and Brian R Sinclair. 2012. "Designed to Change: The Future of Architecture Is Agile," 1–10.
- Ittelson, W. H. 1973. "Environmental Perception and Contemporary Perceptual Theory." In *Environment and Cognition*, 1st ed., 19. New York: Seminar Press.
- Izard, C. E. 1977. *Human Emotions*. New York: Plenum Press.
- Joye, Yannick. 2007. "Architectural Lessons From Environmental Psychology: The Case of Biophilic Architecture." *Review of General Psychology* 11 (4): 305–28. <https://doi.org/10.1037/1089-2680.11.4.305>.
- Kamstra, Aafke, Annette A.J. Van Der Putten, and Carla Vlaskamp. 2017. "Efforts to Increase Social Contact in Persons with Profound Intellectual and Multiple Disabilities: Analysing Individual Support Plans in the Netherlands." *Journal of Intellectual Disabilities* 21 (2): 158–74. <https://doi.org/10.1177/1744629516653037>.
- Karol, Elizabeth, and Dianne Smith. 2019. "Impact of Design on Emotional, Psychological, or Social Well-Being for People With Cognitive Impairment." *Health Environments Research and Design Journal* 12 (3): 220–32. <https://doi.org/10.1177/1937586718813194>.
- Knox, Paul L. 1987. "The Social Production of the Built Environment: Architects, Architecture and the Post-Modern City." *Progress in Human Geography* 11 (3): 354–77. <https://doi.org/10.1177/030913258701100303>.
- Lazarus, R. S., A. D. Kanner, and S. Folkman. 1980. "Emotions: A Cognitive-Phenomenological Analysis." In *Emotion: Theory, Research, and Experience*, 189–217. New York: Academic Press.
- Maleki, Mohammad Reza, and Qader Bayzidi. 2017. "Application of Neuroscience on Architecture: The Emergence of New Trend of Neuroarchitecture." *Kurdistan Journal of Applied Research* 2 (3): 383–96. <https://doi.org/10.24017/science.2017.3.62>.
- McConkey, Roy, Brendan Bunting, Fiona Keogh, and Edurne Garcia Iriarte. 2019. "The Impact on Social Relationships of Moving from Congregated Settings to Personalized Accommodation." *Journal of Intellectual Disabilities* 23 (2): 149–59. <https://doi.org/10.1177/1744629517716546>.
- Minister, Office of the Deputy Prime. n.d. "Final Report for Signage and Wayfinding for People with Learning Difficulties: Building Research Technical Report." <http://www.communities.gov.uk/publication%0As/planningandbuilding/finalreport>.
- Northway, Ruth. 2014. "To Include or Not to Include? That Is the Ethical Question." *Journal of Intellectual Disabilities* 18 (3): 209–10. <https://doi.org/10.1177/1744629514543863>.
- Pask, Gordon. 1969. "The Architectural Relevance of Cybernetics." *Architectural Design* 6 (7): 494–96. <https://doi.org/10.1002/sres.3850100307>.
- Raczka, Roman, Kate Theodore, and Janice Williams. 2020. "An Initial Validation of a New Quality of Life Measure for Adults with Intellectual Disability: The Mini-MANS-LD." *Journal of Intellectual Disabilities* 24 (2): 177–93. <https://doi.org/10.1177/1744629518787895>.
- Ralabate, Patti. 2011. "Universal Design for Learning: Meeting the Needs of All Students." American Speech-Language-Hearing Association. 2011. <https://www.readingrockets.org/article/universal-design-learning-meeting-needs-all-students>.
- Reilly, Catherine V. 2000. "Modifying Home to Accommodate Disabilities: Can Interior Design Professionals Facilitate the Process?" University of Manitoba. <http://dx.doi.org/10.1016/j.jaci.2012.05.050>.
- Salmi, P., D. Ginther, and D. Guerin. 2004. "Critical Factors for Accessibility and Wayfinding for Adults with Intellectual Disabilities." In *Designing for the 21st Century III: An International Conference on Universal Design*. Rio de Janeiro, Brazil.
- Salmi, Patricia. 2007. "Identifying and Evaluating Critical Environmental Wayfinding Factors for Adults with Intellectual Disabilities." Minneapolis - Saint Paul: University of Minnesota.
- Schalock, Robert L., Ivan Brown, Roy Brown, Robert A. Cummins, David Felce, Leena Matikka, Kenneth D. Keith, and Trevor Parmenter. 2002. "Conceptualization, Measurement, and Application of Quality of Life for Persons With Intellectual Disabilities: Report of an International Panel of Experts." *Mental Retardation* 41 (1): 66. [https://doi.org/10.1352/0047-6765\(2003\)041<0066:E>2.0.CO;2](https://doi.org/10.1352/0047-6765(2003)041<0066:E>2.0.CO;2).
- Shanken, Edward A. 2002. "Cybernetics and Art: Cultural Convergence in the 1960s." In *From Energy to Information*, 155–77. Palo Alto: Stanford University Press.
- Shapiro, Michele, Shula Parush, Manfred Green, and Dana Roth. 1997. "The Efficacy of the 'Snoezelen' in the Management of Children with Mental Retardation Who Exhibit Maladaptive Behaviours." *The British Journal of Developmental Disabilities* 43 (2): 140–55. <https://doi.org/https://doi.org/10.1179/bjdd.1997.014>.
- Sheerin, Fintan. 2020. "Our Shared Humanity." *Journal of Intellectual Disabilities* 24 (3): 287–88. <https://doi.org/10.1177/1744629520949809>.
- Sinclair, Brian R. 2013. "People, Design + Environments: A Quest for Deeper Understanding , Greater Connections+A Better World." [http://evds.ualgary.ca/evds\\_info/content/dr-sinclair-people-design-environment-quest-deeper-understanding-greater-connections-better-](http://evds.ualgary.ca/evds_info/content/dr-sinclair-people-design-environment-quest-deeper-understanding-greater-connections-better-)
- . 2014. "Redefining + Redesigning Architectural Education: Beyond Tinkering in an Ethos of Emergency." In *7th International Symposium on Architecture of the 21st Century: In Search of New Paradigms*. Germany.
- . 2017. "Connecting Dots, Valuing Values + Considering Design: Holism, Systems and the Search for Progress." In *Architecture of Complexity: Design, Systems, Society, and Environment*, edited by Windy Smith, Ryan E.; Moore, Keith Diaz; Zhao, 528. Salt Lake City: Integrated Technology in Architecture Consortium.
- Sinclair, Brian R. 2019. "Shelving the Shoehorn : Architectural Resiliency , Responsivity + Responsibility in Spheres of Uncertainty." In *12th International Symposium on Architecture of the 21st Century: In Search of New Paradigm*. Germany.
- Tauke, Beth, and Korydon Smith. 2020. "Marginalized by Design." *Journal of Interior Design* 45 (1): 5–12. <https://doi.org/10.1111/joid.12168>.
- Tuckett, Polly, Ruth Marchant, and Mary Jones. 2004. "Cognitive Impairment, Access and the Built Environment." England.
- Watchman, Karen, Matthew P. Janicki, Leslie Udell, Mary Hogan, Sam Quinn, and Anna Beránková. 2019. "Consensus Statement of the International Summit on Intellectual Disability and Dementia on Valuing the Perspectives of Persons with Intellectual Disability." *Journal of Intellectual Disabilities* 23 (2): 266–80. <https://doi.org/10.1177/1744629517751817>.
- Yin, Robert K. 2014. *Case Study Research: Design and Methods*. 5th Editio. Thousand Oaks: SAGE Publications Ltd.
- Zajonc, R. B. 1980. "Feeling and Thinking: Preferences Need No Inferences." *American Psychologist* 35 (2): 151–75.

# Performative Views in Architecture: Preference, Composition, and Occupant's Wellbeing

Ihab M.K. Elzeyadi<sup>1</sup>

<sup>1</sup>University of Oregon, Eugene, OR

**ABSTRACT:** A substantial portion of the world population spends a minimum of 40 hours weekly in indoor office environments and almost 90% of their time indoors. A fact that placed significant importance on outdoor views in work environments for occupants to maintain connections to nature and the outdoors. Previous studies have attributed a positive correlation between the presence of nature's components in outdoor views and occupant's satisfaction, physiological benefits, mental health, shorter postoperative hospital stays, lower medication dosages, better mood, lower job stress, and reduced churn rates. Despite the favorability of this evidence, the composition of view attributes and components that lead to these positive effects have not been adequately investigated yet. Most previous studies concentrated on the comparisons of views of nature versus urban views preferences, yet failed to acknowledge the complex dimension of view parameters and the percentages of elements of nature within a view, such as percentage of sky area, ground cover, trees, and shrubs. Similarly, the type, quality, and composition of urban views have not been adequately investigated. This study attempts to answer an important yet under-investigated question related to the performative aspects of views and their composition. It also attempts to quantify view preference by developing a metric for view performance and testing its impacts on occupant's wellbeing. The study employed a cross-sectional sorting task survey design to assess view quality outside offices. Data was collected from 175 office participants-- who were given 12 images (Q-sort task) that contain different views compositions--accessible from their offices--which vary from the extreme views of nature to extreme urban views. Results suggest that common classifications of views into two types, views of nature versus urban views, are misleading and do not realistically represent the typical content of views. Instead, a scaled dimension and metric to evaluate views based on their composition is more accurate as it offers a predictive power to measure the performative aspects of views. Findings provide an evidence-based guideline to design a better view for occupants in work environments from the inside-out as well as from the outside-in.

**KEYWORDS:** View Preference/Metrics, Indoor Environmental Quality, Work Environments, Q-sort surveys

## **INTRODUCTION: The Architecture Dimension of Views**

Architects and place designers have continuously embraced the importance of outdoor views from windows in both practice and research scholarship (Ulrich 1984; Kaplan & Kaplan, 1989; Elzeyadi, 2011; Batool et al., 2021). The provision of view-sheds connecting indoor space to the outdoors is often prescribed as a parameter of successful place making and the creation of an architectural memorable experience. Architecture frames outdoor views. Views anchor architecture in context. The reciprocal relationship between buildings and the outdoors sets spatial thresholds for operations between the fields of architecture, landscape, and urban design (Berrizbeitia & Pollak, 1999). Despite the growing interest in the importance of outdoor views, architecture has often prescribed those views as a backdrop, a given, or pre-existing design condition of a building site. This false assumption places architecture and architects as passive receptors of views and consumers of its compositions. Rarely are views and view-sheds of a site, as seen from indoor spaces, considered a dimension of the performative aspects of a building. What if architecture embraces the reciprocity between buildings and views? By asking this question, this paper attempts to not only place outdoor views as design elements of a building but also as a sub-system of spatial indoor environmental quality. The perspective acknowledges the complex system of interactions between view parameters and architectural design as it investigates the quantity and quality of views and their composition. The objective of this paper is to answer an important yet under-investigated question related to the performative aspects of views and their composition in the context of architecture place making. It also attempts to quantify view preference by developing a metric for view performance and testing its applicability to assess occupant's wellbeing.

## **1.0 PERFORMATIVE VIEWS**

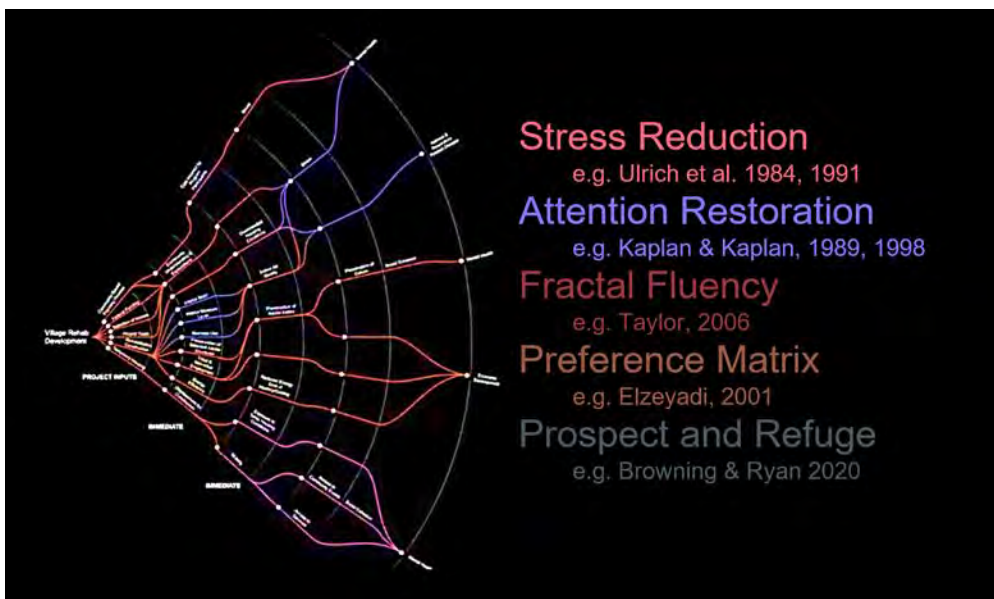
A substantial portion of the world population spends a minimum of 40 hours weekly in indoor office environments and almost 90% of their time indoors (Klepeis et al., 2001). The biophilia hypothesis suggests that there is an instinctive bond between human beings and other living systems (Wilson, 1984). Following Edward Wilson's (1984) seminal text "Biophilia" many building designers adopted these ideas to green, LEED™, and WELL™ certified buildings. A fact that placed significant importance on outdoor views in work environments for occupants to maintain connections to nature and the outdoors. Previous studies have attributed a positive correlation between the presence of nature's components



in outdoor views and occupant's satisfaction (Boubekri, Hull & Boyer, 1991), physiological benefits (Kaplan & Kaplan, 1989), mental health (Li & Sullivan, 2016; Khan et al., 2008), shorter postoperative hospital stays (Ulrich, 1984), lower medication dosages (Roe et al., 2013), better attention (Tennessen & Cimprich, 1992), lower job stress (Shin, Yun & Kim, 2012), and reduced sick leave (Elzeyadi, 2011). Despite the corroboration of multiple evidence suggesting the positive impacts of views, the composition of view attributes and components that lead to these effects have not been adequately investigated yet. Most previous studies concentrated on the comparisons of views of nature versus urban views preferences (Kaplan & Kaplan, 1989) yet failed to acknowledge the complex dimension of view parameters and the percentages of elements of nature within a view, such as percentages of sky area, ground cover, trees, and shrubs. Similarly, the type, quality, and composition of urban views have not been adequately investigated. Moreover, most previous studies failed to develop a view metric to both quantify and evaluate different views or a scale to predict their impact separately or collectively on occupant's wellbeing. By responding to these knowledge limitations, this study adopts the rationale behind the long-debated hypothesis of the importance building occupants place on the need to be in contact with nature and the outdoors (the biophilia hypothesis). Specifically, it investigates what aspects and composition of outdoor views and view-sheds might explain this positive acceptance of the biophilia hypothesis. In addition, the study develops a metric for view preference as a performative measure for view design.

## 2.0 VIEW COMPOSITION PREFERENCE THEORIES

A number of competing theories explain the effect of view preference on building occupants outcomes (Figure 1). These are; *Stress Reduction*, *Attention Restoration*, *Fractal Fluency*, *Preference Matrix*, and *Prospect and Refuge* theories. The following is an explanation of each of them.



**Figure 1:** Theories of views related to the built environment, their inter-linkages, and seminal studies for each theory (visualization concept after Xuting Jin).

**2.1 Stress Reduction Theory** assumes that human contact (physical/visual) with nature will reduce the recovery time from stress (Ulrich, 1984). The theory hypothesizes that exposure to nature through window view helps people recover from stress and mental fatigue (Ulrich et al., 1991). As per evolutionary psychology, the human mind is a collection of programs or modules, which produce cognitive output in response to inputs. On exposure to nature through a window view, positive response mechanisms of a human brain become activated by the restorative natural content in the view (Tooby & Cosmides, 1992). Vegetated elements in a window view are perceived as life-like elements capable of causing restorative responses. The evolutionary framework of the theory suggests further that exposure to natural settings and a mix of natural and urban settings can promote stress reduction. Previous studies investigated stress reduction of humans to exposure of different landscape types (Beil & Hanes, 2013; Roe et al., 2013; Ward Thompson et al., 2012). The higher proportion of vegetation in urban areas would contribute to greater stress reduction. A recent experiment investigated the impact of increasing density of urban tree canopies on the stress recovering time of human subjects (Jiang et al., 2014). Individuals, after being involved in a stressful activity, were asked to watch one of the ten three-dimensional videos of street scenes with varying densities of tree canopies. Gender differences were observed, as women experienced no relationship between varying densities of tree cover and self-reported stress recovery. For men, as tree cover density increased from 1.7 to 24%, stress recovery increased, while tree canopy density of 24% to 34% resulted in no change in stress recovery across genders. Tree density above 34% was associated with slow recovery for all participants regardless of gender designation.

**2.2 Attention Restoration Theory** assumes that physical/visual exposure to nature helps recovery from mental fatigue (Kaplan & Kaplan, 1989). In stressful environments, occupants tend to engage in rumination, which stands for repeated engagement with a thought. Rumination increases the chances of depression and mental illness. To stay attentive, one should be free from distractions and repeated thoughts. The attention restoration theory posits that window view to natural elements (e.g. trees, flowers, water) restores the human mind's capacity to focus as it provides an opportunity to rest and restore (Kaplan, Kaplan, & Ryan, 1998). A well-designed study investigated the impact of views of nature through windows, LCD screens, and no views on participant's stress recovery found a substantial reduction in recovery time for the view of nature from windows on the rate of recovery from stress followed by the LCD screen nature's views, and urban scenes (Khan et al., 2008). Experiments employed in usability testing laboratory involved eye-tracking surveys to find that visual aesthetics and complexity in natural scenes had a statistically significant relationship with restorative effect (Kang & Kim, 2019).

**2.3 Fractal Fluency Theory** is closely related to the Attention Restoration Theory, it postulates on "Phytophilia" and its relationship to human beings. Fractals are characterized by the parameter called fractal dimension (D). The "D" quantifies the scaling of a fractal pattern at different magnifications and repetitions. The visual complexity of a composition with a fractal pattern increases with the rise in D. Fractals can be categorized based on their D values as ones with; low (D=1.1–1.3), medium (D=1.3–1.5), and high complexity (D=1.5–1.9). Fractals existing in nature exhibit randomness, where patterns repeat at different scales. Fractal patterns with a medium level of complexity are the most restorative, relaxing, and reliever of stress (Hagerhall et al, 2008; Taylor, 2006). In addition, fractal patterns affect human preference. It has been found that fractal patterns within the range D= 1.3-1.5, attract human visual preference (Spehar & Taylor, 2013; Taylor et al., 2005; Spehar et al., 2003) in laboratory settings while patterns in the range of D 1.5-1.7 were more preferred and correlated with perceptions of relaxation and interest in real space settings (Abboushi & Elzeyadi, 2018, Abboushi et al., 2019).

**2.4 Preference Matrix Theory** The preference matrix theory assumes that people enjoy views that exhibit high levels of understanding and involvement (Nassar, 1994). Views that offer better understanding are the ones that have features like coherence and legibility. Outdoor views through windows with higher coherence are perceived to be more attractive than non-coherent views. The coherence of a view can be identified by the predictability of the dimensions of the orientation of its content. Complexity is achieved by multiple shapes, colors, and textures in a view. The quality of mystery in a view suggests that it has more to offer, so much so, that it tempts the viewer to discover it further. A recent study found that these abstract features of window views elicited psychological reactions fitting with the characteristics of those features (van Esch et al., 2019). The study surveyed office occupants who had views of either urban or nature settings. It was found that views of urban settings possess inherent features like familiarity and understanding that showed significant association to occupants' accessibility. Whereas for nature settings, the inherent features of coherence and complexity showed significant association with occupants' well-being and relaxation. These features present in an occupant's view-shed of the window better predicted psychological, physical, and job-specific well-being than the overall amount of nature in the view (Milligan & Bingley (2007). The aesthetic features for views of urban environments show that the issue with urban environments is that they may appear too monotonous or too complex (Stamps, 2004). Preference for these views has an inverted U-shape relationship with complexity (Imamoglu 2000).

**2.5 Prospect-Refuge Theory** assumes that the two features; prospect and refuge in a view provide a perception of safety (Appleton, 1975). Prospect, in this case, means the openness of a view from the indoors. Prospect offers long-range visibility and the sensation of the ability to see without being seen. People prefer views with some level of prospect. Refuge, according to this theory refers to views with opportunities to hide and seek shelter, such as caves, alcoves, dense shrubs, etc. Views with some level of the refuge feature are preferred by people as they provide a sensation of 'being protected' in adverse weather or challenging situations (Gill et al., 2015). In agreement with the 'prospect-refuge' theory, previous studies in architectural planning, interior architecture, and daylighting have found a strong correlation between the degree of openness of a view and human preference (Batty, 2001; Dawes & Ostwald, 2013 & 2014; Dosen & Ostwald, 2013). Parallel to the investigations on the impact of view features on preference, few studies focused on finding the impact of quantified spatial properties of a room and window on preference (Fisher-Gewirtzman et al., 2003; Zhang & You, 2018). One such study found that "human spatial perceptions" are related to a room's geometry and the three-dimensional isovist measures of the window based on the occupant's view-shed (Dosen & Ostwald, 2017). This study stated that architectural properties of space/room like; its shape, volume, color, lighting/daylighting, and window opening form have a relationship with human perception of 'openness' of views. Further, the openness of views is the most important variable that influences an occupant's satisfaction with the room.

### 3.0 A PREFERENCE STUDY OF ARCHITECTURAL FRAMED VIEWS

A recent study thoroughly investigated the contents of window views in dense residential settings in Iran (Masoudinejad & Hartig, 2018). The study showed how view contents varied with the floor level. The ground floor window-views included streets, pedestrians, pavements, trees, automobiles, and people. The intermediate floor views offered views to neighboring buildings and the top-floor views consisted of the sky, roofs of neighboring buildings, far landscapes, etc. The investigation included the production of simulated window-views with variation in view content for views of different floor levels. For the intermediate views, an element called 'window-box' (external window-sill planter) was introduced. The simulated views were rated by over 200 University students for restoration quality and restoration

likelihood or preference. It was found that the higher proportion of sky and presence of window box in the view had direct impacts on view preference ratings. Ground floor views containing streets, trees, and people earned similar ratings as the views with the sky. However, as hypothesized by Appleton's prospect refuge theory, the views rated to be most restorative were the ones containing a portion of the sky. Among the limitations of this study is the lack of evidence as to what other components or percentage of the view content correlates with people's preference for the views.

To overcome these methodological limitations, the current study was conducted in an office building of a semi-urban university campus. The building houses the university's administrative and student service offices occupying an open-plan office setting facing different views and view-sheds by the occupants. Multiple administrative departments occupy the building, which include academic advising, student services, admissions, registrar, financial aid, veterans' affairs, international education, student life, multicultural affairs, and human resources offices. The building represents an opportunity to study the questions under investigation. The typical open-plan office building has 30% of offices overlooking a view of nature to the north and part of the west, 31% of its offices are looking at an urban view to the south and east, and the remaining 39% of the offices are internal open-plan offices with no outdoor views. Within each one of the three identified sections of the building, four different views represent variations for each of the three identified categories of nature, urban, and mixed nature/urban. Administrative staff with similar demographics and organizational culture occupy all the offices in the building. The perimeter offices of the building facing north, east, south, and west are a mix of private and open-plan staff offices. The inward-facing open-plan offices are shared offices separated by 4-6 ft. high partitions with some fully enclosed offices for directors. In general, there is no significant work classification hierarchy existing between departments and employees occupying the perimeter and internal open-plan offices. Entire departments occupied some of the inward-facing offices with multiple staff classifications and organizational hierarchy. Figure 2, below describes the building, its view-shed groups, and floor plans.



**Figure 2:** Floor plans of the study setting with multiple view-shed types

A multi-method research design with a research triangulation approach was employed to investigate the study questions. First, a Q-sort technique was employed to uncover participants' preferences for different views. Second, a view content analysis was conducted using image pixel-rasterization and High Dynamic Range Imagery (HDRI) false-color luminous renderings. Third, the impact of view-shed on participants' well-being was computed from responses to a questionnaire survey to demonstrate the percentage of sick-building-syndrome (SBS) symptoms experienced by the participants over the last year (Figure 3).

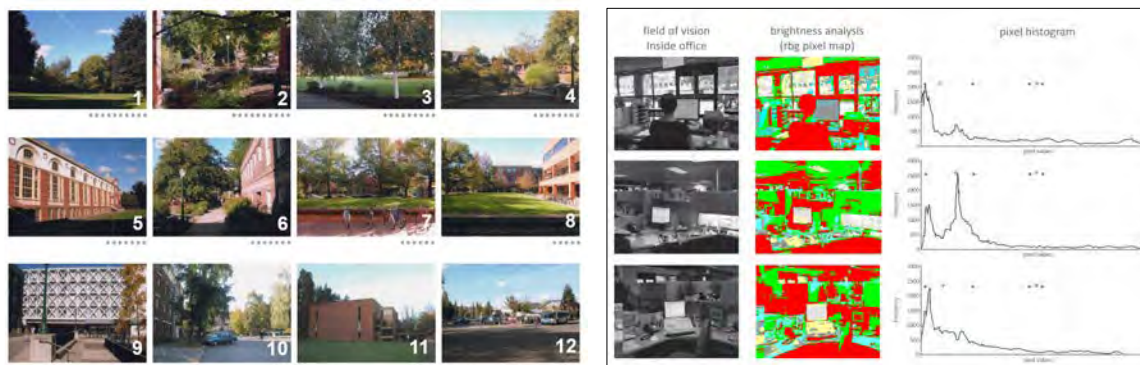


**Figure 3:** Multi-method approach for data collection included: (1) Q-Sort preference task, (2) Environmental Assessment Protocol, and (3) Participants Well-being Inventory using Simple Form 12 to collect SBS symptoms

### 3.1 Q-Sort Task

Participants' preferences and ratings for natural, urban, and a mix of natural-urban views were conducted using a qualitative multiple sorting task technique (Q-sort). The Q-sort task was employed followed by in-depth interviews on a cross-sectional sample of participating employees occupying various spaces of the building with different view-sheds. One hundred and seventy-five (N=175) full-time employees representing both classified and unclassified employees voluntarily participated in the study to rank 8"x10" photographic images of 12 office-views surrounding the study setting and other various offices on campus that ranged from forest-like natural scenes to urban street scenes (Figure 4). In a two-stage sorting procedure, participants were first asked to sort the images according to their degree of preference for outdoor views as seen from their work area. The multiple sorting tasks started by ranking the 12 images into three

sorting piles; *Best*, *Average*, and *Worst*. In a second follow-up procedure, participants were asked to sort the top, medium, and low views within each sorted pile. After the completion of the multiple sorting tasks, participants were interviewed using a guide to solicit their reasons for ranking the twelve views and were prompted to identify elements in the sorted views that influenced their rankings. The Q-sort procedure resulted in a rigorous approach for indicating preferences as participants were able to compare their rankings in a scaled approach relevant to the other views presented.



**Figure 4:** The 8x10 high-quality prints set that were given to participants to Q-sort them in an un-numbered randomized deck (left). Environmental Quality Inventory (EQA) of each participant office setting and view-shed analysis (right)

### 3.1 Indoor Environmental Quality Assessment (EQA)

To measure participants' environmental conditions and assess their view-shed content analysis, an in-situ EQA procedure was administered. The physical conditions of each participant's work area were assessed for glare, lighting quantity, and view-shed content. This included daylighting availability (window shape, properties, glazing, area, and its location from employee's desks); Daylighting quality and variability (such as luminance, illuminance, cubic illuminance, room material properties, orientation, glare, and brightness patterns); Quality of outside views (such as type of view [urban-natural], pleasantness rating [from Q-sort task], preference, and view-shed content analysis). This procedure was systematically administered to all 175 participants' workstations. Physical site-surveyors were trained to record the physical conditions of the work areas for the employees included in the study. Digital images of the office spaces representing the field of vision and view-sheds of each participant's viewing area from their workstation were analyzed using a High Dynamic Range Imagery (HDRI) luminous intensity scene analysis procedure. The images were color-coded and rasterized for luminous quality and pixel match to reflect the image scene components of the view.

### 3.2 Occupant's Health Assessment

In addition, a physical screening and survey of employees' health conditions, Sick-Building-Syndrome (SBS) symptoms using a modified Standard Simple Form (SF-12). This information was cross-tabulated with physical environmental factors from the EQA of each participant's workstation/office and analyzed. The study controlled for factors that may have influenced participant's seating position, type of work, and office classification as well as the inclusion of demographic and organizational parameters to control for any impact of mediational variables.

## 4.0 VIEWS AND INDOOR ENVIRONMENTAL QUALITY

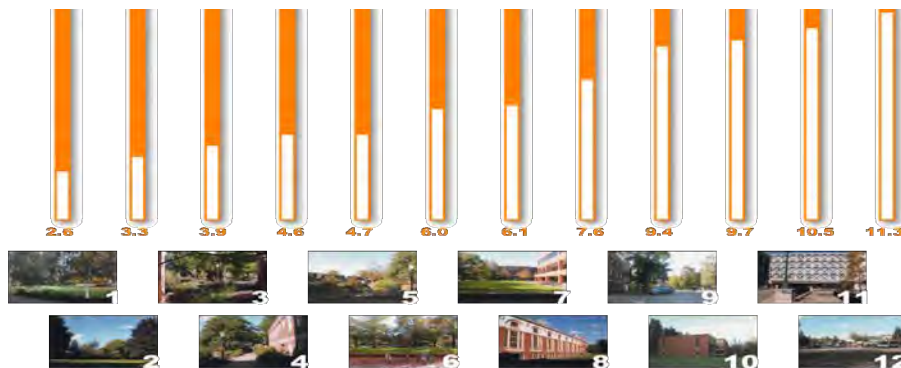
Participants unanimously agreed to the importance of views in the workplace and perceived them important to relieve stress and combat the feeling of confinement inside offices. Results of the interviews indicate a strong perception that views and view-sheds are as important as other parameters of Indoor Environmental Quality (IEQ) such as visual comfort, thermal comfort, and acoustics.

### 4.1 View Preference Scale

Results indicate an agreement of those surveyed to rank views with more nature content at the top of their preference with wild forest-like settings to be more preferred than manicured and structured landscaping. Urban views containing large areas of streets and parking lots consistently ranked lowest and views with a mix of natural elements within urban settings and interesting architecture with natural materials such as brick, stone, and wood to be consistently in the middle ranks (Figure 5). Participants with no views in internal-facing offices were reportedly interested in any view over their internal view-sheds of the open-plan offices. Although they preferred views with more nature content, consistent with the rest of the participants, they were willing to accept any view over internal offices view-sheds. Participants occupying cubicles and workstations with no access to outdoor views (39% of employees) had more density of posters, postcards, and computer screen backgrounds with views of nature scenes. The findings corroborate previously reported a preference for views of nature and nature contents attributes. A metric and scale, however, was not previously developed. Based on the findings we have developed a views preference metric and scale to rate employees'



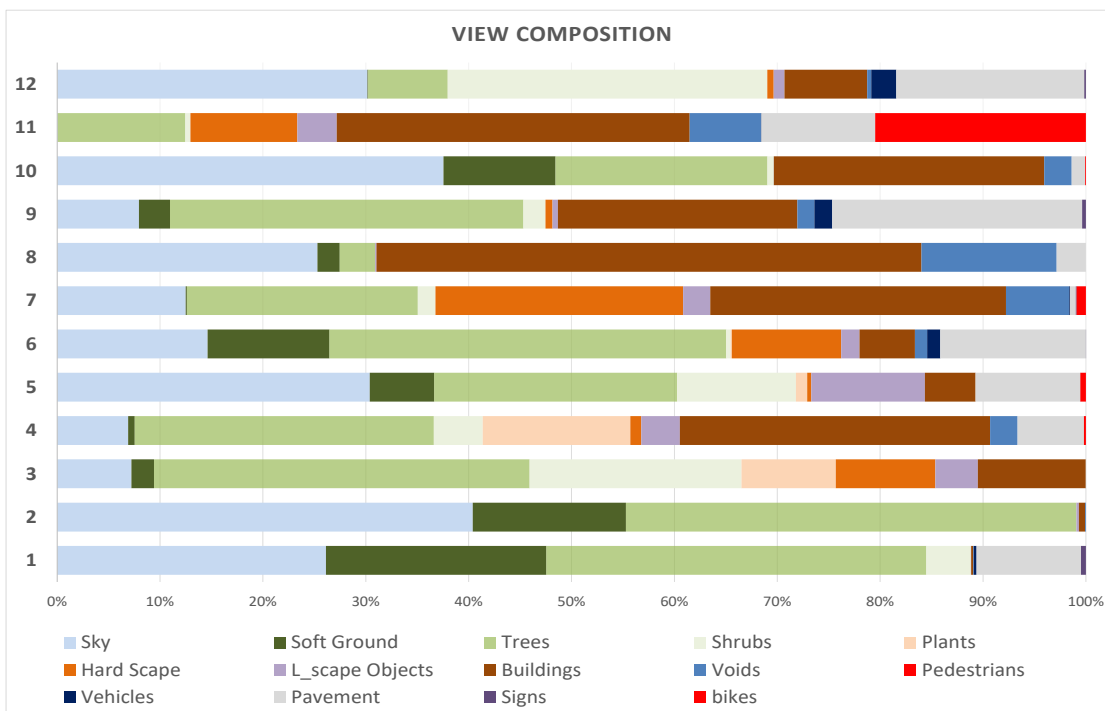
preference for different types of views. This allowed us to evaluate employee's preferences for outdoor views from windows for the setting under study. The Poor View Quality (PVQ) scale could be further tested in future studies towards its adoption for views assessment ratings (Figure 5).



**Figure 5:** Ranking of views after Q-sort task (PVQ lower numbers represents a better view preference)

### 4.1 View Composition

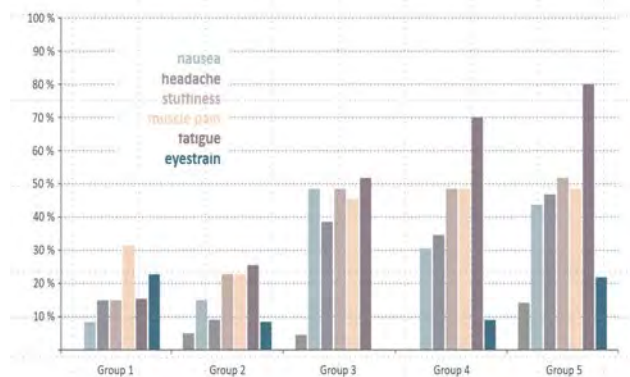
In addition to verifying the view preference metric, the twelve views with various content of nature and urban attributes provided a rich data set to investigate the importance of the percentage of content within each view that is related to its preference rankings. Fourteen different attributes that range from elements of nature to build form and both landscape and transportation objects (bicycles and cars) were analyzed for each view. The percentage of each element of the view content was pixelated and computed as a percentage of the entire view image/view-shed. Results indicate an agreement of those surveyed to rank views with more nature content at the top of their preference. The presence of sky percentage in the view is the most important element of nature that correlated with a better view rating. This was followed by the presence and percentage of trees, shrubs, soft ground, and plants. Hardscape, buildings, landscape objects, pedestrians, windows, and voids in buildings are of mid importance and correlated positively with better view preference as long as they were proportionally less in area than the natural elements identified within the same view. Paved areas, street networks, parking lots, and cars were constantly grouped among the un-preferred content of views, especially when present with large percentages within a view. Figure 6 breakdown the content analysis of each of the 12 views, with view number one rated as the most preferred view and view number 12 as the least preferred view, respectively.



**Figure 6:** View composition attributes as a percentage of the overall image content with view #1 as most preferred and view #12 the least preferred

## 4.2 View Well-being

Results of the SF-12 survey used to collect participants' incidents of SBS symptoms experienced over the last year were geo-coded with the participants' office location and grouped into five categories. Group 1 represented participants with work areas exposed to highly rated views of nature numbers 1-3. Group 2 represented participants occupying moderately rated views numbers 4-6. Groups 3 and 4 were of participants occupying work areas with lower to lowest rated views numbers 7-12 respectively, while group 5 consisted of participants' work areas with internal open-office views only. It is interesting to note that group 5 had the most reported symptoms of SBS followed by group 4, and 3. Groups 1 and 2 reported consistent low percentages of SBS symptoms experienced (Figure 7).



**Figure 7:** SBS symptoms prevalence as a function of view groups (Group 1 most nature-content attributes and Group 5 no nature-content attributes)

## CONCLUSION: Towards A Performative View Metric

This study attempts to answer and quantify a long-debated hypothesis regarding the importance non-residential building occupants place on the need to be in contact with nature and the outdoors (the biophilia hypothesis) while working within a building. Results suggest that the current classification of views into two types: views of nature versus urban views is misleading and does not realistically represent the typical content of the views. Instead, a scaled dimension and metric to evaluate views based on their composition and content of their attributes is more accurate. In this regard, 14 attributes were found to be significant when selecting or designing views and viewsheds exposures. Positive attributes are sky cover, trees, shrubs, soft ground, plants, and pedestrians; while negative attributes are paved areas, street networks, parking lots, and cars. Of equal importance are mid-quality attributes related to human-designed objects, such as hardscape, buildings, landscape objects, windows, and voids/windows in buildings. The composition of these attributes was computed the Poor View Quality (PVQ) metric to predict the impact of views on occupant's wellbeing. The fact that preferred views and view-sheds were correlated with 60-70% fewer SBS symptoms reported is not trivial when one considers productivity and health insurance costs of an organization.



**Figure 8:** A conceptual framework of performative views as a sub-system of architecture's IEQ performance

The findings provide an evidence-based guideline to design a better view for the occupant's in work environments from the inside-out as well as from the outside-in. In addition, results create a body of knowledge regarding the relationship between human health, view quality, and building IEQ performance (Figure 8). The hope that these results would influence architects and building designers to design with views and not merely as a response to it. It sheds light on the importance of occupant's view-sheds and activity as a design parameter of building performance. It also establishes a base reference concerning the effect of fenestration systems and views on the health and well-being of occupants from a human-centered perspective.



## REFERENCES

- Abboushi, B., Elzeyadi, I., Taylor, R., & Sereno, M. (2019). Fractals in architecture: The visual interest, preference, and mood response to projected fractal light patterns in interior spaces. *Journal of Environmental Psychology*, 61, 57-70.
- Appleton, J. (1975). *The experience of landscape*. London: Wiley.
- Aries, M. B. C., Veitch, J. A., & Newsham, G. R. (2010). Windows, view, and office characteristics predict physical and psychological discomfort. *Journal of Environmental Psychology*, 30(4), 533-541. <https://doi.org/10.1016/j.jenvp.2009.12.004>
- Batool, A.; Rutherford, P.; McGraw, P.; Ledgeway, T. & Altomonte, S. (2021). Window Views: Difference of Perception during the COVID-19 Lockdown, LEUKOS, DOI: 10.1080/15502724.2020.1854780
- Batty, Michael, (2001). Exploring Isovist Fields: Space and Shape in Architectural and Urban Morphology. *Environment and Planning B: Planning and Design*, 28 (1): p. 123-150.
- Beil, K., & Hanes, D. (2013). The influence of urban natural and built environments on physiological and psychological measures of stress—a pilot study. *International Journal of Environmental Research and Public Health*, 10(4), 1250-1267.
- Benedikt, Michael L, (1979). To Take Hold of Space: Isovists and Isovist View Fields. *Environment and Planning B: Planning and Design*, 6 (1): p. 47-65.
- Berrizbeitia, A. & Pollak, L. (1999). *Inside Outside: Between Architecture and Landscape*. Rockport Publishers, Massachusetts.
- Boubekri, M., Hull, R. B., & Boyer, L. L. (1991). Impact of window size and sunlight penetration on office workers' mood and satisfaction: A novel way of assessing sunlight. *Environment and Behavior*, 23(4), 474-493
- Dawes, Michael J., and Michael J. Ostwald, (2013). Using Isovists to Analyse Prospect-Refuge Theory: An Examination of the Usefulness of Potential Spatio-Visual Measures. *The International Journal of the Constructed Environment*, 3 (1): p. 25-40.
- Dawes, Michael J., and Michael J. Ostwald, (2014). Testing the 'Wright Space': Using Isovists to Analyse Prospect-Refuge Characteristics in Usonian Architecture. *Journal of Architecture*, 19 (5): p. 645-666.
- Dosen, A. S., & Ostwald, M. J. (2017). Lived space and geometric space: Comparing people's perceptions of spatial enclosure and exposure with metric room properties and isovist measures. *Architectural Science Review*, 60(1), 62-77.
- Elzeyadi I. (2012). Workplace Design: Health and healing impacts of daylight and views in the workplace: *World Health Design*, July 2012, p. 60-65.
- Elzeyadi, I. (2011). *Daylighting-Bias and Biophilia: Quantifying the Impacts of Daylighting on Occupants Health.* Thought and Leadership in Green Buildings Research 2011. Washington, DC: USGBC Press.
- Farley, K. & Veitch, J. 2001. *A Room with a View: A Review of the Effects of Windows on Work and Well Being*. Institute for Research in Construction, NRC.
- Gill, N., Dun, O., Brennan-Horley, C., & Eriksen, C. (2015). Landscape preferences, amenity, and bushfire risk in New South Wales, Australia. *Environmental Management*, 56(3), 738-753.
- Hagerhall, C., Laike, T., Kuller, M., Marcheschi, E., Boydston, C., & Taylor, R. (2015). Human physiological benefits of viewing nature: EEG responses to exact and statistical fractal patterns. *Nonlinear Dynamics, Psychology, and Life Sciences*, 19(1), 1-12.
- Imamoglu, Ç. (2000). Complexity, liking, and familiarity: architecture and non-architecture Turkish students' assessments of traditional and modern house facades. *Journal of Env. Psych.*, 20(1), 5-16.
- Jiang, B., Chang, C. Y., & Sullivan, W. C. (2014). A dose of nature: Tree cover, stress reduction, and gender differences. *Landscape and Urban Planning*, 132, 26-36.
- Kahn Jr, P. H., Friedman, B., Gill, B., Hagman, J., Severson, R. L., Freier, N. G. & Stolyar, A. (2008). A plasma display window? — The shifting baseline problem in a technologically mediated natural world. *Journal of Environmental Psychology*, 28(2), 192-199.
- Kang, Y., & Kim, E. J. (2019). Differences of Restorative Effects While Viewing Urban Landscapes and Green Landscapes. *Sustainability*, 11(7), 2129.
- Kaplan, R. (2001). The Nature of the View from Home: Psychological Benefits. *Environment and Behavior*, 33(4), 507-542. <https://doi.org/10.1177/00139160121973115>
- Kaplan, R., & Kaplan, S. (1989). *The experience of nature: A psychological perspective*. Cambridge: Cambridge University Press.
- Kaplan, R., Kaplan, S., & Ryan, R. L. (1998). *With People in Mind: Design and Management of Everyday Nature*. Washington, DC: Island Press.
- Leather, P., Pyrgas, M., Beale, D., & Lawrence, C. (1998). Windows in the workplace: Sunlight, view, and occupational stress. *Environment and Behavior*, 30(6), 739-762.
- Li, D., & Sullivan, W. C. (2016). Impact of views to school landscapes on recovery from stress and mental fatigue. *Landscape and urban planning*, 148, 149-158.
- Masoudinejad, S., & Hartig, T. (2018). Window view to the sky as a restorative resource for residents in densely populated cities. *Environment and behavior*, 0013916518807274.
- Milligan, C., & Bingley, A. (2007). Restorative places or scary spaces? The impact of woodland on the mental well-being of young adults. *Health & Place*, 13, 799-811.
- Nasar, J.L. (1994). Urban design aesthetics: The evaluative qualities of building exteriors. *Environment and Behavior*, 26(3), 377-401.
- Roe, J., Ward Thompson, C., Aspinall, P. A., Brewer, M. J., Duff, E., Miller, D., Mitchell, R., & Clow, A. (2013). Green space and stress: Evidence from cortisol measures in deprived urban communities. *International Journal of Environmental Research and Public Health*, 10(9), 4086-4103
- Shin, J. Y., Yun, G. Y., & Kim, J. T. (2012). View types and luminance effects on discomfort glare assessment from windows. *Energy and Buildings*, 46, 139-145.
- Spehar, B., & Taylor, R. (2013). Fractals in art and nature: Why do we like them? *Proceedings of SPIE - The International Society for Optical Engineering*, 8651, 865118. <http://doi.org/10.1117/12.2012076>.
- Taylor, R. (2006). Reduction of physiological stress using fractal art and architecture. *Leonardo*, 39(3), 245-251. <http://doi.org/10.1162/leon.2006.39.3.245>.
- Tennessen, C. M., & Cimprich, B. (1995). Views to nature: Effects on attention. *Journal of Environmental Psychology*, 15, 77-85.
- Tooby, J., Cosmides, L., 1992. The psychological foundations of culture. In: Barkow, J.H., Cosmides, L., Tooby, J. (Eds.), *The Adapted Mind. Evolutionary Psychology and the Generation of Culture*. Oxford University Press, New York, pp. 19-136.
- Ulrich, R. S., Simons, R. F., Losito, B. D., Fiorito, E., Miles, M. A., & Zelson, M. (1991). Stress recovery during exposure to natural and urban environments. *Journal of Environmental Psychology*, 11, 201-230.
- Ulrich, R. (1984). View through a window may influence recovery. *Science*, 224(4647), 224-225.
- Wilson, E.O., 1984. *Biophilia: The Human Bond with Other Species*. Harvard University Press, Cambridge.

# Biophilic Net-Positive Architecture: Integrating Nature, Health, Wellbeing and Passive Design

Mary Guzowski<sup>1</sup>

<sup>1</sup>University of Minnesota, Minneapolis, MN

**ABSTRACT:** The energy, carbon, and environmental benefits of net-positive design have received much attention, but less so the health, wellbeing, and experiential promises. Architects Pamela Mang and Bill Reed suggest that the definition of “net-positive” should be expanded to “*buildings that ‘add value’ to ecological systems and generate more than they need to fulfil their own needs’ moves net-positive beyond simply a technical challenge . . . [by including] benefits to the systemic capability to generate, sustain and evolve the life of a particular place* (Mang and Reed, 2014, 1)”. Could a biophilic approach to net-positive architecture provide an expanded understanding of health and wellbeing for humans, other species and the planet? Architect Stephen Kellert identified biophilic design as the “largely missing link” in sustainable design: “*Without positive benefits and associated attachment to buildings and places, people rarely exercise responsibility or stewardship to keep them in existence over the long run....Low-environmental-impact and biophilic design must, therefore, work in complementary relation to achieve true and lasting sustainability* (Kellert et al., 2008, 5)”. This paper discusses a seven-week graduate architecture studio that explored the potential “added value” of a biophilic approach to net-positive architecture, using the Architecture 2030 *Energy Design Hierarchy* and Terrapin’s *14 Patterns of Biophilic Design* to address the design, programmatic, performance, and experiential dimensions of biophilic net-positive architecture (Architecture 2030, 2020; Terrapin 2014). Integrated biophilic net-positive architectural goals, strategies, performance metrics, and tools will be discussed to support human and ecological health and wellbeing.

**KEYWORDS:** Net-Positive Architecture, Biophilic Design, Passive Design, Health Design

## INTRODUCTION

Could aesthetics, beauty, atmosphere, health, and wellbeing be as important to net-positive design as are reductions in energy and environmental impacts? From a regenerative design perspective, architects Pamela Mang and Bill Reed suggest that the definition of “net-positive” should be expanded beyond energy performance to include broader considerations: “*...buildings that ‘add value’ to ecological systems and generate more than they need to fulfil their own needs’ moves net-positive beyond simply a technical challenge...[by including] benefits to the systemic capability to generate, sustain and evolve the life of a particular place* (Mang and Reed, 2014, 1)”. To “sustain and evolve” life and the places we live requires not only attention to the environmental impacts of design as measured in carbon and energy reductions, but also to respect and care for nature and other species. This includes awareness of and appreciation for the unique qualities, culture, and biological diversity of place. Architect Stephen Kellert identified biophilic design as the “largely missing link” in sustainable design: “*Without positive benefits and associated attachment to buildings and places, people rarely exercise responsibility or stewardship to keep them in existence over the long run....Low-environmental-impact and biophilic design must, therefore, work in complementary relation to achieve true and lasting sustainability* (Kellert et al., 2008, 5)”. This paper discusses a seven-week graduate architecture studio that investigated the potential “added value” of a biophilic approach to net-positive design by integrating the Architecture 2030 *Energy Design Hierarchy* and Terrapin’s *14 Patterns of Biophilic Design* (Architecture 2030, 2020; Terrapin 2014) with an emphasis on passive design strategies to optimize energy and carbon reductions while also fostering connections to nature, sense-experiences, time and seasons, and nature-based health benefits. The discussion includes the biophilic net-positive framework, strategies, metrics, tools, outcomes, and lessons to simultaneously support human, environmental, and ecological health and wellbeing.

## 1.0 BIOPHILIC NET-POSITIVE STUDIO OVERVIEW

### 1.1. Design brief and clients

The required seven-week Net-Positive Design Studio is offered in the spring of the second year of the three-year M.Arch Program at the University of Minnesota. A cohort of instructors teach parallel studios with a program requirement to introduce students to the architectural opportunities and trade-offs of net-positive design, with a focus on building operational energy and carbon reduction strategies, metrics, and assessment methods. After seven weeks, a new instructor joins the student cohort for the Comprehensive Design Studio to further develop the building technologies, structure, construction details, and mechanical and renewable systems. The project brief involved design of a 10,000

square foot Center for Health and Wellbeing. Drs. Mary Jo Kreitzer and Pamela Cherry of the Bakken Center for Spirituality and Healing (CSH) acted as clients. They helped to frame the program (which was a similar project slated for future development at the university), served as guest critics, and acted as resource experts on health and wellbeing. A hypothetical project site was chosen in a business district on the north boundary of campus. The site afforded excellent solar and wind access and opportunities to enhance biodiversity and connections to the Mississippi River and proposed urban habitat within an old railway corridor.

### 1.2. Framing the problem

To launch the studio, Dr. Kreitzer introduced the goals of the CSH and their “Wellbeing Model,” which includes six dimensions: 1) health, 2) relationships, 3) security, 4) purpose, 5) community, and 6) environment (Figure 1). As Dr. Kreitzer explained, ecological and human health must be simultaneously considered: “Wellbeing is ... about finding balance in body, mind, and spirit. These take into account our interconnectedness and interdependence with ... the personal and global environment we live in (CSH, 2020).” During the seven-week studio, students investigated the following topics, which are addressed in the discussion below: 1) Resources for a biophilic approach to net-positive design, 2) Integrating *Terrapin’s 14 Patterns of Biophilic Design* and the *Energy Design Hierarchy*, and 3) Design processes for a biophilic approach to net-positive design.



**Figure 1:** Wellbeing Model, Center for Spirituality and Healing. Source: (CSH, 2020)

## 2.0 RESOURCES FOR A BIOPHILIC APPROACH TO NET POSITIVE

### 2.1. Biophilic and net-positive design resources

Working with seminal texts and related design standards, groups of students started by exploring how biophilia fits within a larger sustainable and regenerative design trajectory. Reviewing the history and evolution of biophilic and net-positive design helped to discern underlying design goals, strategies, methods, and potential intersections. The concept of biophilia or “love of life” was introduced nearly fifty years ago by psychologist Eric Fromm, in his book *The Anatomy of Human Destructiveness*: “*Biophilia is the passionate love of life and of all that is alive; it is the wish to further growth, whether in a person, a plant, an idea, or a social group* (Fromm, 1973)”. Biologist and naturalist E.O. Wilson popularized the term in his seminal text *Biophilia: The Human Bond with Other Species*, with his “Biophilia Hypothesis” suggesting that there is an “*innate emotional affiliation of human beings to other living organisms* (Wilson, 1984, 1)”. Two decades later, architect Steven Kellert and colleagues translated these concepts into design theory, principles, and strategies, including six biophilic topics and seventy-two design elements (Kellert, Heerwagen, Mador, 2008). Building on the work of Kellert et al., the firm Terrapin Bright Green formulated *Terrapin’s 14 Patterns of Biophilic Design* (Terrapin, 2014). *Terrapin’s 14 Patterns* were selected as a biophilic design framework for the studio, as the patterns provide concise and designer-friendly goals and strategies (Table 1).

Design standards for biophilic, health, and net-positive design were reviewed to understand the design approaches and metrics, including the Living Building Challenge (LBC), Fitwel System, and WELL Building Standards. Students explored the parallel histories of the biophilic and sustainable design movements of the 1990s, which gained momentum with development of LEED, BREEAM, and other international guides. In 2006 that the International Living Futures Institute (ILFI) introduced the Living Building Challenge 1.0 (LBC 1.0) with the aspirations for “net-zero” energy, water, and waste as well as a focus on issues such as beauty and equity (LBC, 2006). In 2009, biophilia was first cited in the LBC 2.0 standard under the topic of health (LBC 2.0, 2009). In 2014, the LBC 3.0 shifted goals from “net-zero” to “net-positive” for energy, water, and waste (LBC, 2014). In support of Kellert’s biophilic strategies, the ILFI recently published the *Biophilic Design Guidebook*, a supplemental resource for the LBC, as well as Amanda Sturgeon’s book *Creating Biophilic Buildings* (ILFI, 2018, Sturgeon, 2017).

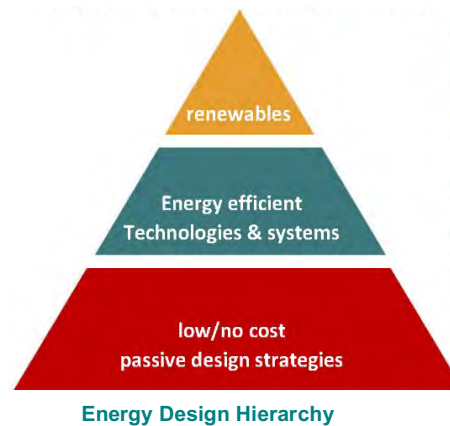
### 2.2. Affinity between biophilic and net-positive design

While perhaps overlooked, there is an affinity between biophilic and net-positive design, both of which respond to nature and environmental forces to achieve respective design goals. As traditionally defined, the primary goal of net-zero and net-positive architecture is energy reduction, as clarified by the U.S. Department of Energy in the publication *A Common Definition for Zero-Energy Buildings*: “An energy-efficient building where, on a source energy basis, the actual annual delivered energy is less than or equal to the on-site renewable exported energy” (DOE, 2015). Yet, as Mang and Reed suggest, “net-positive” can be defined to bring “added value,” which could include biophilic benefits among other issues. Kellert suggests that the first goal of biophilic design is to enhance contact with nature to foster health, fitness, and wellbeing (Kellert, 2015). When biophilic and net-positive goals are coupled, “added values” are revealed that foster human and ecological health and wellbeing, as well as place-based sensory and atmospheric experiences of nature and natural forces.

The challenge of integrating two seemingly parallel design goals was to identify a net-positive framework that could be integrated with *Terrapin's 14 Patterns*. In 2002, architect Ed Mazria made an impassioned call to the design professions and allied industries to adopt the *Architecture 2030 Challenge*, a global initiative to achieve “carbon neutrality” for greenhouse gas (GHG) emissions in “new buildings, developments, and major building renovations” by the year 2030 (Architecture 2030, 2020). In the past two decades, we have seen the design professions strive to not only meet zero, but to move towards net-positive energy. This aspirational target continues to challenge designers toward ever-higher standards and more effective strategies. The 2030 timeline has recently been extended by a decade with an international design initiative entitled *Zero by 2040*. The 2040 target supports the goal of the Paris Agreement to limit the global temperature increase by 1.5 degree C over the next two decades (Architecture 2030, 2020). The global *Zero by 2040* target couples architectural design with innovative technologies and systems by employing the *Energy Design Hierarchy*, which includes three levels of design: 1) apply low/no cost passive design strategies to achieve maximum energy efficiency, 2) integrate energy efficient technology and systems, and 3) incorporate on-site and/or off-site renewable energy to meet the remaining energy demands (Figure 2). Students found that the first level of the *Energy Design Hierarchy*, which focuses on passive design strategies (daylighting, natural ventilation, and passive heating and cooling) was easily coupled with biophilic design patterns in response to the unique conditions of place, site, fauna and flora, sense experiences, and atmospheric qualities of seasons and time. The second and third levels of the *Energy Design Hierarchy* (technologies and renewable systems) were more challenging due to an indirect relationship to biophilic design; however, levels two and three were explored by focusing on how mechanical and renewable energy systems help to reveal and reframe human-nature relationships within the framework of energy consumption, environmental impact, and seasonal environmental forces. *Terrapin's 14 Patterns* and the *Energy Design Hierarchy* provided a framework to integrate goals, strategies, and metrics for biophilic net-positive design (Table 1 and Figure 2).

TERRAPIN'S 14 (15)* PATTERNS OF BIOPHILIC DESIGN		
Nature in Space Patterns	Nature Analogue Patterns	Nature of Space Patterns
1. Visual Connection with Nature	8. Biomorphic Forms & Patterns	11. Prospect
2. Non-Visual Connection with Nature	9. Material Connection with Nature	12. Refuge
3. Non-Rhythmic Sensory Stimuli	10. Complexity & Order	13. Mystery
4. Thermal & Airflow Variability		14. Risk/Peril
5. Presence of Water		15. Awe*
6. Dynamic & Diffuse Light		
7. Connections with Natural Systems		

\*Terrapin added a fifteenth pattern in 2020: “#15: Awe”, which is not discussed



**Table 1:** Terrapin's 14 Patterns of Biophilic Design. Source: (Terrapin, 2014)

**Figure 2:** Net-Zero Energy Design Hierarchy. Source: (Author, based on “Zero by 2040”, Architecture 2030, 2020)

### 3.0 AN INTEGRATED BIOPHILIC NET-POSITIVE DESIGN FRAMEWORK

#### 3.1. Passive integration of the Energy Design Hierarchy and Terrapin's 14 Patterns

The three levels of the *Energy Design Hierarchy* provided both direct and indirect means of connecting net-positive design and *Terrapin's 14 Patterns* to inform the site design, building form and massing, envelope, solar control and shading, materials and structure, and room details. The following table reveals example design intersections and qualitative and quantitative considerations and metrics between the first level of passive design strategies in the *Energy Design Hierarchy* and *Terrapin's 14 Patterns* (Table 2).



Passive design strategies through the lens of Terrapin's 14 Patterns of Biophilic Design		
Terrapin's 14 Patterns	Passive Design and Terrapin's 14 Patterns	Qualitative and Quantitative Performance Metrics
<b>NATURE IN SPACE</b>	<i>Passive Design: Nature in Space Considerations</i>	<i>Net-Positive Considerations</i>
<b>1. Visual Connection with Nature</b>	Daylight, natural ventilation, and passive design to enhance visual access to nature and natural forces through siting, orientation, building form, section, envelope, room configuration, and window design	Quantitative assessment of the integration of bioclimatic and passive strategies to reduce lighting, heating, cooling, and natural ventilation loads. Potential integration of health and energy performance metrics: <ul style="list-style-type: none"> <li>- <i>Energy and sustainability targets:</i> Energy Use Intensity (EUI): kBtu/SF; lbsCO<sub>2</sub>; Architecture 2030 targets; technologies and renewable energy systems integration.</li> <li>- <i>Daylighting &amp; electric lighting targets:</i> point-in-time and annual climate-based metrics (IESNA recommendations, Spatial Daylight Autonomy, Annual Sunlight Exposure, etc.); electric lighting integration.</li> <li>- <i>Circadian daylight &amp; electric targets:</i> equivalent melanopic lux, circadian stimulus; electric lighting integration; nighttime strategies to eliminate circadian disruption (blackout shades, night-time navigation).</li> <li>- <i>Visual comfort targets:</i> glare control, views, daylight management, color rendering, electric lighting integration.</li> <li>- <i>Thermal comfort targets:</i> ASHRAE, adapted thermal comfort.</li> </ul>
<b>2. Non-Visual Connection with Nature</b>	Daylight, natural ventilation, and passive design to enhance sounds, smells, thermal experiences related to site, building form, and envelope.	
<b>3. Non-Rhythmic Sensory Stimuli</b>	Daylight, natural ventilation, and passive design to enhance ephemeral and dynamic sensory connections and experiences of nature.	
<b>4. Thermal &amp; Airflow Variability</b>	Daylight, natural ventilation, and passive integration with seasonal luminous and thermal experiences and comfort.	
<b>5. Presence of Water</b>	Integration of water elements with seasonal luminous, thermal, and acoustic experiences for site, envelope, and window design. Phase change of water, sounds, reflections, and refractions integrated with luminous and thermal comfort.	
<b>6. Dynamic &amp; Diffuse Light</b>	Seasonal program appropriate daylight strategies and zoning for dynamic and diffuse light (daylight versus sunlight). Daylight and high-performance systems to respond to light and sky conditions.	
<b>7. Connections with Natural Systems</b>	Passive design strategies to respond to seasonal and temporal changes in daylight availability, solar radiation, sky conditions and to enhance connections to atmospheric, biological, hydrologic, geological, and human-environmental systems.	
<b>NATURAL ANALOGUE</b>	<i>Passive Design: Nature Analogue Considerations</i>	<i>Net-Positive Considerations</i>
<b>8. Biomorphic Forms &amp; Patterns</b>	Biomorphic building form, materials, sections, envelope and details for daylight, natural ventilation, and passive design to enhance literal, metaphoric, or symbolic nature analogues.	<ul style="list-style-type: none"> <li>- Quantitative and qualitative assessments of building form, materials, and spatial organization to optimize the integration of net-positive design through siting, bioclimatic, passive strategies, and electric integration.</li> <li>- Quantitative considerations on how passive strategies improve health and wellbeing and relate to net-positive to reduce energy and GHG.</li> </ul>
<b>9. Material Connection with Nature</b>	Material thermal and luminous properties (mass, color, textures, and reflectivity) to support atmospheric goals and optimize passive design.	
<b>10. Complexity &amp; Order</b>	Integration of daylight, natural ventilation, and passive heating and cooling to create seasonally rich and varied sensory experiences.	
<b>NATURE OF SPACE</b>	<i>Passive Design: Nature of Space Considerations</i>	<i>Net-Positive Considerations</i>
<b>11. Prospect</b>	Integration of daylight, natural ventilation, and passive strategies with desired spatial, experiential, and atmospheric qualities such as site connections, views, illuminance levels, contrast ratios, and luminous journey.	<ul style="list-style-type: none"> <li>- Qualitative assessment of luminous, thermal, and experiential qualities</li> <li>- Quantitative considerations on related quantitative implications for net-positive performance on a seasonal basis.</li> </ul>
<b>12. Refuge</b>		
<b>13. Mystery</b>		
<b>14. Risk/Peril</b>		

**Table 2:** Passive design through the lens of Terrapin's 14 Patterns of Biophilic Design. Source: (Terrapin, 2014; author, 2020)

### 3.2 Design exercises

After exploring the potential intersections between the *Energy Design Hierarchy* and *Terrapin's 14 Patterns*, students worked with six exercises that considered the integration and trade-offs between poetic, pragmatic, and performance-based design issues and goals. Students selected biophilic patterns from the three categories based on their individual approaches to programming the site and building. The six exercises were organized into three phases and grouped into two exercises in each phase to corresponded with the three categories of the *Terrapin's 14 Patterns* and three levels of the *Energy Design Hierarchy* (Figure 3).

### 3.3. Phase One: Nature in Space Patterns and the Energy Design Hierarchy

The first and second exercises explored the intersections between "low/no cost passive design strategies" in the *Energy Design Hierarchy* and *Terrapin's #1-7: Nature in Space Patterns*. The first seven patterns directly intersect with passive design strategies, given the focus on qualitative site and bioclimatic conditions, flora and fauna, seasonal experiences, views, and connections to the sun, wind, water, precipitation, and changing seasonal sense-experiences. The net-positive energy approach to passive design strategies were considered from a bioclimatic and experiential perspective,

while also considering thermal and luminous comfort, energy and GHG performance through the site, building massing, and early concepts for seasonal and dynamic envelope strategies. The CHS Wellbeing Model was revisited to consider health and wellbeing.

### 3.3.1 Discovering: Exercise 1: Biophilic journey (nature of place)

The students began with iterative site visits to document and define a proposed “Biophilic Journey” (Figure 4). Exercise 1 used time-lapse video, photographs, diagrams, and collage to illustrate the relationships between biophilic phenomena of nature and place while considering potential bioclimatic and passive response to seasonal conditions for sun, wind, precipitation, flora and fauna. They considered “existing conditions” and “potential design responses” to support the intersection of biophilic, net-positive and wellbeing goals. Students considered the seasonal and diurnal “biophilic journey” to explore how the site and building spatial organization, massing, and strategies might reduce energy while enhancing human experience, habitat and connections with nature. Climate Consultant was used to analyze bioclimatic forces, the psychometric chart, solar tools, design strategies, and case study links to the 2030 Palette (Climate Consultant, 2020; 2030 Palette, 2020).

### 3.3.2 Exploring: Exercise 2: Biophilic atmosphere and passive potential (nature and energy)

Iterative “atmosphere boxes” were used to study the experience and phenomena of nature early in the process (Figure 4). In Exercise 2, students scale-jumped from the site to the interior of the main assembly room. While the first two exercises focused on Patterns #1-7, the atmosphere boxes allowed students to also consider other patterns related to materials, structure, and the quality of space. Working from the inside-out, they developed iterative physical study models using a simple  $\frac{1}{4}'' = 1'-0''$  box to explore the biophilic atmosphere (such as connection with nature, site, time, and weather) while weighing net-positive issues for daylight, natural ventilation, and passive solar design. Altering only one or two variables per study, students developed multiple “atmosphere boxes” and photographed the incremental alterations to compare the changing qualities of light and material effects for select seasons. The atmosphere studies were useful in elevating the experiential dimension of biophilia in relation to passive strategies for net-positive.

### 3.3.3 Assessing: Weekend workshop #1: daylight, thermal, and passive optimization

At the end of the second week, Chris Wingate (an architect at MSR) and Pat Smith (a Research Fellow at the Center for Sustainable Buildings) conducted the first Sefaira energy-modelling workshop (Figure 4). Parametric analysis methods were used to evaluate daylighting and passive design strategies and energy and carbon performance. Students selected one proposal (or a hybrid from the early scenarios) as a “base case” and iteratively altered one or two design variables to compare performance relative to the base case, including: building massing and number of stories; orientation; glazing area, orientation and percentage; presence or absence of shading; and presence or absence of natural ventilation. Summaries of the parametric studies included site-building massing diagrams and performance data, including: 1) Annual Energy Use per Gross Internal Area: kBtu/square foot (vs Architecture 2030 targets); 2) Annual CO<sub>2</sub> Production: lbs CO<sub>2</sub>; 3) Spatial Daylight Autonomy (sDA) and 4) Annual Sun Exposure (ASE). While students were not required to attain a “net-positive energy target,” they were asked to investigate “how low they could go” by only reducing energy through site and architectural design strategies. The second workshop introduced additional reductions through envelope variables, building systems, and renewable energy. Students compared the advantages and disadvantages of bioclimatic and passive design scenarios in relation to their net-positive, biophilic, and health goals. One project scenario was selected to move forward in phase two exercises.

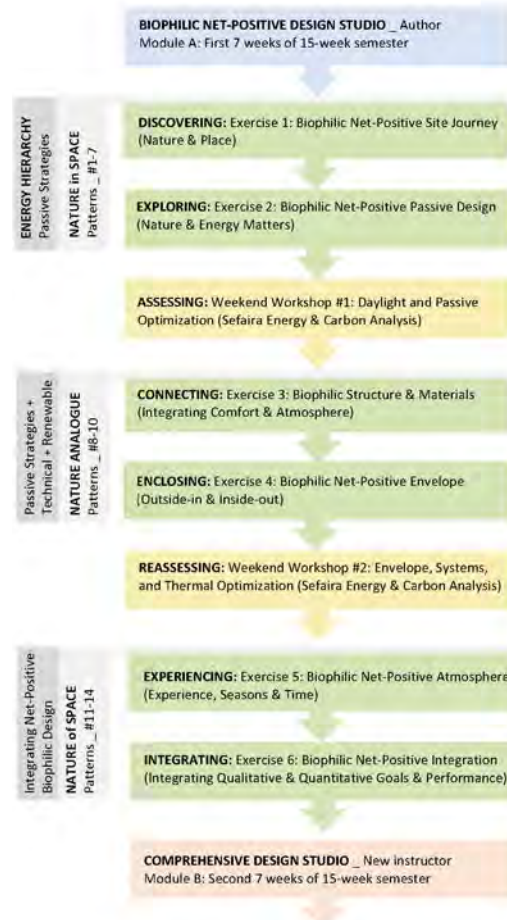


Figure 3 Biophilic net-positive exercise framework. Source: (Author, 2020)





**Figure 4:** Example site, massing, atmosphere, and Sefaira workshop #1 studies. (Source: Shay Koohi, Yalun Chen, Drew Tangren, Yifan Liu.)

### 3.4. Phase Two: Nature Analogue Patterns and the Energy Design Hierarchy

The third and fourth exercises explored the intersections between all three levels of the *Energy Design Hierarchy* (including passive, efficient technologies, and renewable systems) and *Terrapin's #8-10: Nature Analogue Patterns*. These studies added additional biophilic patterns to consider materials, structure, and details to support biophilic atmospheric and experiential goals while refining the passive strategies and systems integration for net-positive design. The Wellbeing Model was revisited to further consider health.

#### 3.4.1 Connecting: Exercise 3: Biophilic programming (comfort and atmosphere)

In Exercise 3, students personalized and further developed the program brief based on emerging design concepts. A “biophilic program” was developed for each space and activity using narrative text, precedents, and nature images to refine seasonal experiential, atmosphere, material, and structural design goals. After refining the program, students scale-jumped back to iterative site-building massing and section physical models using one or two of *Terrapin's 14 Patterns* from the second category (Nature Analogues) to explore structure and material scenarios in relation to thermal, luminous, and atmospheric goals and connections to site and nature.

#### 3.4.2 Enclosing: Exercise 4: Biophilic structure & materials (outside-in & inside-out)

A refined site-building massing scenario was selected and a seasonal envelope program was developed to consider the biophilic and net-positive design concepts and goals for each façade orientation including the roof. Students considered early envelope goals, concepts, structure, and materials from the interior quality of spaces and the exterior façade attributes (Figure 5). Iterative scenarios were developed using annotated exploded axonometric diagrams and precedent studies. Each façade was considered in terms of the effect of orientation, activities, and the site relationships from the outside-in and the inside-out. Students developed renderings, collage or time-lapse digital videos to compare biophilic strategies with the seasonal qualities of daylight, passive solar, and shading for net-positive, while weighting the biophilic and experiential connections to site, time, and nature.

#### 3.4.3 Reassessing: Weekend workshop #2: envelope, systems, and thermal optimization

In the second Sefaira workshop, students selected one proposal (or a hybrid of strategies) to use as a “base case design” and multiple scenarios were developed by altering design variables that included massing, size and location of glazing, shading, envelope thermal parameters, glazing parameters, and HVAC and renewable energy systems. A summary of comparative graphics and performance data was developed to assess each design scenario, including: 1) Annual Energy Use per Gross Building Area: kBtu/ square foot, 2) Annual CO<sub>2</sub> Production from energy use (lbs CO<sub>2</sub>); 3) Spatial Daylight Autonomy (sDA) and Annual Sun Exposure (ASE); 4) Total energy breakout from Sefaira; 5) HVAC system type selected; 6) Amount of photovoltaic panels (in square feet) needed to meet the 2019 performance targets for Architecture 2030 Challenge (70% carbon reduction below the regional average for building type); and Amount of photovoltaic panels to achieve net-positive design. Based on net-positive, biophilic, and wellbeing goals, students selected one proposal to develop in the remaining three weeks of the studio (Figure 5).



**Figure 5:** Example material and structure studies. (Source: Yalun Chen, Zixing He, Mitch Lampe, Emma Rutkowski, Brandon Thompson, Yuyi Lin.)

### 3.5. Phase Three: Nature of Space Patterns and the Energy Design Hierarchy

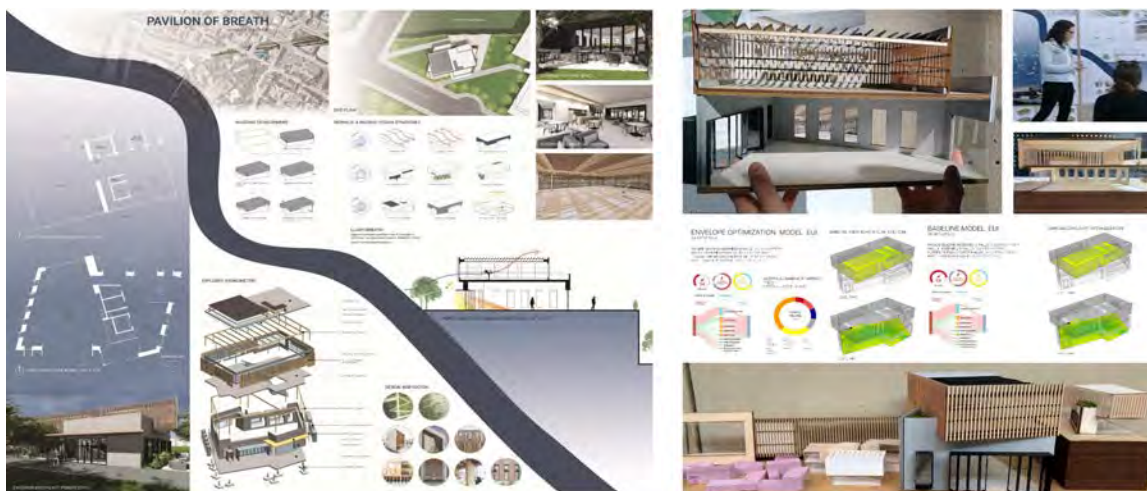
The last two exercises focused on schematic design resolution of the poetic and experiential dimensions of biophilic design and the passive and systems integration of net-positive design at the site and building scales. Previous biophilic patterns were reconsidered in the context of the third category of patterns (Nature of Space) to further develop the experiential and atmospheric qualities while maintaining net-positive goals for the three levels of the Energy Design Hierarchy and final consideration of the Wellbeing Model.

#### 3.5.1 Experiencing: Exercise 5: biophilic envelopes (seasons & time)

Using an in-class charette, the site-building massing and envelope scenarios were revisited to integrate the second Sefaira energy analysis workshop. Annotated seasonal site-building section drawings further developed net-positive and biophilic strategies for summer versus winter. Following the charette, students selected “one important room” to develop  $\frac{1}{2}'' = 1'-0''$  physical envelope detail models of select wall conditions. Envelope detail drawings and renderings further illustrated seasonal responses to daylight, natural ventilation, passive solar and connections to site, views, habitat, natural systems and select biophilic patterns (Figure 6).

#### 3.5.2: Integrating: Exercise 6: Biophilic net-positive synthesis (experience & performance)

In the last two weeks, students illustrated the integration of biophilic patterns and net-positive design strategies at the site, building, room, and envelope scales (Figure 6). One select room was studied using a  $\frac{1}{2}'' = 1'-0''$  detailed physical model to study the quality of space and envelope. The group defined the required drawings and models for the final review, including concept diagrams, seasonal rendered site-building sections and/or axonometric drawings, structure and envelope exploded axonometric or detail drawings, Sefaira performance assessments, and a client summary. Physical models included the final room model, envelope detail studies, and all process models. The final biophilic net-positive schematic design proposal was taken into the following seven-week Comprehensive Design Studio to develop the structure, materials, and systems.



**Figure 6:** Example final project. (Source: Whitney Donohue.)

## CONCLUSION

The Biophilic Net-Positive Studio outcomes include the following conclusions and lessons:

1. *Explore biophilic design as a “missing link” in sustainable – regenerative design:* Elevating the experiential dimensions of nature, place, and health and wellbeing for people, other species, and the planet expanded the design explorations beyond the traditional – and essential - net-positive design focus on energy and GHG. Combining the biophilic lens with net-positive revealed that nature-based design patterns and strategies can also celebrate the beauty of place, time and seasonal phenomena, sense-based experiences, and the interconnections with all life.
2. *Take a fresh look at passive design to integrate biophilic and net-positive design:* The studio explorations revealed the relative ease with which passive and bioclimatic design can be integrated with passive strategies for net-positive design. The three levels of the *Energy Design Hierarchy* and *Terrapin’s 14 Patterns* provided an accessible framework to explore the direct connections between passive design and the “Nature in Space Patterns” and material, structure and atmospheric and experiential connections with the “Nature Analogue” and “Nature in Space Patterns”.
3. *Work with qualitative and quantitative assessment tools to integrate biophilic net-positive design:* Assessment tools and performance metrics for net-positive design are well-developed compared to those for biophilic design. Despite the nascent state of biophilic performance tools and standards, there is clear evidence of the health benefits of nature connections in architectural design (Africa, 2019, Terrapin 2020). Traditional qualitative design tools of physical modeling, rendering, photography, video, and collage are essential and of great value in assessing the intersections between net-positive and biophilic design strategies from experiential and atmospheric perspectives on health and wellbeing.
4. *Integrate poetic, practical, and performance design goals and concepts early in the process:* Introducing qualitative studies early in the design phase integrated biophilic experiential and atmospheric strategies with practical performance goals for net-positive design. Scale-jumping between site, room, building, and envelope balanced poetic, pragmatic, and performance-based goals and criteria.
5. *Next Steps:* Building on the lessons of the studio, additional attention will be given to the emerging biophilic and health metrics from the LBC, Fitwel System, and Well Building Standard.

## ACKNOWLEDGEMENTS

The author gratefully acknowledges the contributions of Drs. Mary Jo Kreitzer and Pamela Cherry, Chris Wingate and Pat Smith, and the students participating in the Biophilic Net-Positive Studio. The *Net-Positive Design Studios* are supported by the Marvin Collaboration, a three-year industry sponsorship by Marvin to promote net-positive and integrated design innovations and excellence.

## REFERENCES

- Africa, Julia, Heerwagen, Judith, Loftness, Vivian, and Ryan Balagtas, Catherine. 19 March 2019. “Biophilic Design and Climate Change: Performance Parameters for Health,” *Frontiers: Perspective*.
- Architecture 2030. 2020. *Accelerating to Zero by 2040!* <https://architecture2030.org/accelerating-to-zero-by-2040/>.
- Architecture 2030. 2021. *Architecture 2030 Challenge*, [https://architecture2030.org/2030\\_challenges/](https://architecture2030.org/2030_challenges/).
- Architecture 2030. 2021. *2030 Palette*, <http://2030palette.org/>.
- Browning, B. and Cooper, C. 2015. *Human Spaces*, Atlanta GA: Interface: [https://greenplantsforgreenbuildings.org/wp-content/uploads/2015/08/Human-Spaces-Report-Biophilic-Global\\_Impact\\_Biophilic\\_Design.pdf](https://greenplantsforgreenbuildings.org/wp-content/uploads/2015/08/Human-Spaces-Report-Biophilic-Global_Impact_Biophilic_Design.pdf).
- Browning, Bill and Ryan, Catie. 2020. *Nature Inside: A Biophilic Design Guide*. London: Royal Institute of British Architects.
- Center for Spirituality and Healing. 2020. *Wellbeing Model*. University of Minnesota, <https://www.csh.umn.edu/about-us/wellbeing>.
- Milne, Murray. 2020. *Climate Consultant 6.0*. Los Angeles, CA: University of California, <http://www.energy-design-tools.aud.ucla.edu/climate-consultant/request-climate-consultant.php>.
- Edward O. Wilson. 1984. *Biophilia*, Cambridge: Harvard University Press.
- Fitwel Organization. 2020. *Fitwel Certification System*. <https://www.fitwel.org/>.
- Fromm, Eric. 1973. *The Anatomy of Human Destructiveness*, New York: Holt Rinehart and Winston
- International Living Building Institute. 2018. *Biophilic Design Guidebook*, Seattle: International Living Future Institute.
- International Living Building Institute. 2020. *Living Building Challenge 2.0 and 4.0*, <https://living-future.org/lbc/>.
- International Well Building Institute. 2020. *WELL Building Standard*. <https://www.wellcertified.com/>
- Kellert, Stephen R. October 26, 2015. What Is and Is Not Biophilic Design? New York: Metropolis, <https://www.metropolismag.com/architecture/what-is-and-is-not-biophilic-design/>.
- Kellert, Stephan R., Heerwagen, Judith H., and Mador, Martin L. 2008. *Biophilic Design*, New Jersey: John Wiley & Sons, Inc.
- Kellert, S, and Wilson, E. O. 1993. “Biophilia and the Conservation Ethic,” *Biophilia Hypothesis*. Washington DC: Island Press.
- Mang, Pamela, and Reed, Bill. 2014. “The Nature of Positive,” *Building Research & Information*, Volume 43, 2014 – Issue 1: <https://www.tandfonline.com/doi/full/10.1080/09613218.2014.911565>.
- Sturgeon, Amanda. 2017. *Creating Biophilic Buildings*. Seattle: International Living Futures Institute.
- Terrapin Bright Green. 2014. *Terrapin’s 14 Patterns of Biophilic Design*. New York: Terrapin, <https://www.terrapinbrightgreen.com/reports/14-patterns/>.
- US Green Building Council, *Leadership in Energy and Environmental Design (LEED)*, <https://new.usgbc.org/leed>.



# Imaginations of Humanitarian Design: Material Versus Social Innovation in the Emergency Shelter

Natalie Florence Severy<sup>1</sup>, Philip Plowright<sup>2</sup>

<sup>1</sup>Arizona State University, Tempe, AZ

<sup>2</sup>Lawrence Technological University, Southfield, MI

**ABSTRACT:** The emergency shelter is an architectural response to humanitarian crises. The metrics of success and failure of emergency shelters, which have influenced much of the research on the architecture of displacement, have focused on the potential of emergency shelters to improve quality of life for refugees. A successful product promises to liberate people and decrease human suffering. However, to date there is limited critique of how emergency shelters engage with the narratives and imaginations of migration management and humanitarian design. The gap in knowledge exists in understanding the relationships between organizations that are involved in the design of emergency shelters, and the discourse used to construct narratives of desirable and better futures for those in need.

In this study, we address the Better Shelter housing product as a case study. The Better Shelter is a transitional housing unit designed for deployment for refugee camps worldwide. These shelters were conceived by a private group, Better Shelter of Sweden, and distributed by the IKEA Foundation to the United Nations High Commissioner for Refugees (UNHCR). This shelter must balance the goals of humanitarian organizations and the needs of refugees, in different locations around the world. At times, this negotiation creates a conflict of interests. A Grounded Theory approach is used, supported by the theoretical framework of Sociotechnical Imaginations to investigate the “collectively held, institutionally stabilized, and publicly performed visions of desirable futures” in refugee camps (Jasanoff et al., 2009). With a multi-modal approach, this paper argues how the knowledge and its material embodiments, the Better Shelter, are products of a shared understanding of what life could be for refugees. The intention of the paper is to advance the understanding of the vision of the Better Shelters, which often exists in tension with social entrepreneurs and humanitarian organizations.

**KEYWORDS:** refugee, emergency shelter, humanitarian design, IKEA Foundation, UNHCR

## INTRODUCTION

The United Nations High Commissioner for Refugees (UNHCR) is the global authority in the phenomena of displacement with a mandate to help and protect “refugees, returnees, stateless people, the internally displaced and asylum-seekers” (UNHCR, n.d.). The UNHCR was established to help refugees after World War II to help millions of displaced people in Europe. Over the past 70 years, this organization has established itself as a world leader in humanitarian aid for displaced people focused on providing sustainable, context appropriate solutions for housing and improving quality of life for refugees in duress (UNHCR, n.d.). The organization works with local and regional governments to provide sheltering options that are varied and site specific. They provide refugee camps and support alternatives where appropriate, demonstrating authority with decades of involvement in the complex issue of displacement. The organization is also invested in creating, implementing, and negotiating long term, sustainable solutions to either integration or assimilation of refugees, depending on context, which include sheltering options but also dynamic goals for poverty eradication.

The emergency shelter is one material product that the UNHCR uses to alleviate immediate suffering in their mission to protect and shelter displaced people. Providing emergency shelter is a component of a larger strategy to improve overall quality of life, where quality of life is also measured by the UNHCR as access to health care, cash allowances, and education opportunities for refugees to have “brighter futures” (UNHCR, n.d.). While the selection and application of emergency shelters is a field application and policy directive, it is also an architectural response to humanitarian crises.

The metrics of success and failure of emergency shelters, which have influenced much of the research on the architecture of displacement, have focused on the potential to improve quality of life and decrease suffering for refugees (i.e., a “brighter future”), an outcome aligned with the goals of the humanitarian development sector. However, to date there is limited critique of the dynamic factors involved in providing a brighter future, a qualitative statement that moves well beyond basic survival of the individual. One issue is the alignment between the narratives and imaginations of migration management and humanitarian design. Responses to displacement are invariably framed by privatized and

humanitarian organizations, such as IKEA and the UNHCR, whose capacity is somewhat limited to the world view that encampment is the only option for refugees. It raises the question of how material solutions, provided by private organizations like the IKEA foundation, to social crisis enable or even further encampment.

To address this gap between organizational relationships and the discourse used to construct narratives of desirable and better futures for those in need this paper focuses on the goals and worldviews of the designers who engage humanitarian design responses contrasted with the goals and world views of migration management organizations.

In 2010, the UNHCR paired with a private social entrepreneur, The Better Shelter RHU AB design group, to collaborate, develop, and fund an innovative sheltering option for refugee camps that is easy to pack, ship, and assemble (Scott-Smith 2019). This sheltering option is known as the Better Shelter, named the same as the Swedish design group responsible for its origin. Pairing progressive production and shipping approaches developed by the IKEA furniture company and with material innovations such as a rigid structure, impermeable walls, and lockable doors, the Better Shelter promised to improve quality of life for refugees.

To navigate the assemblages of people, products, and ideas involved in the development of the Better Shelter, we are using the theoretical framework of socio-technical imaginaries, defined here as “imagined forms of social life and social order that center on the development and fulfillment of innovative scientific and/or technological projects.” (Jasanoff, Kim and Sperling, 2006,1). The research approach uses an epistemological position that considers scientific and technological products, such as refugee housing, as co-produced with social practices, identities, discourses, and norms (Jasanoff 2004). This approach rejects technological determinism and acknowledges that science and technology do not unidirectionally shape our world but, instead, are integral to the co-production, or “the mutual, bi-directional relationship between knowledge and social organization of science, politics and culture” (Miller 2018, 48).

## 1.0 SOCIO-TECHNICAL IMAGINARIES

Sociotechnical imaginaries are “collectively imagined forms of social life and social order reflected in the design and fulfillment of nation-specific scientific and/or technological projects” (Jasanoff and Kim 2009,120). They are both descriptive of what kind of futures are possible and prescriptive of the kinds of futures that should be attained (Jasanoff, Kim and Sperling 2009). While societies regularly develop imaginaries of how life should be or might be in the future (Hacking 1999; Auger 2013; Hales 2013), what distinguishes a sociotechnical imaginary is the relationship between the social and the material innovations of technological products in constructing diverse and desirable futures (Jasanoff and Kim 2019). Sociotechnical imaginaries, thus, are developed by shared understandings of social life and social order made possible through and supported by advances in science and technology.

This way of thinking situates technology as interdependent with a progressively integrated material, moral, and social landscape - not unlike the futures typically encountered in science fiction. Outside of science fiction, there are few functional models that exist for engaging technology and future forecasting. While it could be stated that professional designers, such as architects and industrial designers, are focused on bringing products and environments into existence, there is often a lack of clarity around the social effects of their material and formal innovation (Miller and Bennett 2008). Emergency shelters, for example, provide much needed housing for displaced populations but often these material solutions are disconnected from larger social issues such as the militarization of borders, or a lack of human or social capital (Scott-Smith 2019; Seferiadis et al 2015).

Sociotechnical imaginaries are important aspects of our contemporary life because these narratives help to socially construct a collective identity of what is considered good and evil, concepts associated with defining justice and human-to-human relations. In this paper, the focus is on the discourse of humanitarian design. The potential of imaginaries is not only to construct a shared understanding of what has been done in the past and what is promised for the future but to position those pasts and futures as something desirable and to be accepted or rejected, based on learned ideas of right and wrong. This temporal component is a fascinating part of humanitarian aid as the past invariably confronts crimes against humanity and, by extension, any future forecasting must promise to alleviate this kind of suffering.

While sociotechnical imaginaries can be found in material innovations of fabricated products, they also engage symbolic and cultural references to build their narratives. These narratives become the language of power and one of the modes for the construction of a sociotechnical imaginary which links design innovation with a vision for a possible future (Jasanoff 2015). The relation between social expectation, material technical development, and cultural positioning makes a sociotechnical imaginary often part of a larger social movement.

Related to sociotechnical imaginaries is co-production, a “shorthand for the proposition that the ways in which we know and represent the world (both nature and society) are inseparable from the ways in which we chose to live in.” (Jasanoff 2004) While there is great analytic potential in technology studies to incorporate ideas of co-production, there is an essential piece lacking with this theoretical framework in understanding how things have come to be as they are (Jasanoff 2015; Bijker and Hughes 2012). Co-production engages the interrelationship between various aspects of our world and experiences, but it does not consider that some individuals and organizations have more power to affect change than others (Foucault 1979).

The theories of sociotechnical imaginaries confront some of the limitations of co-production in respect to power imbalances, cause, and agency. (Mitchell 2002; Farias and Bender 2009, as cited in Jasanoff, 2015). They reveal the power that some people have over others and the political nature of decision making in the development and selection of innovative technology. Where design studies focused on technical innovation have previously focused on the relationship of materials, objects, and people, a sociotechnical imaginary is focused on the construction of reality through narrative, policy, and discourse of collectively held and performed visions of a desirable future or an active resistance against an undesirable future (Jasanoff 2015).

Engaging products such as emergency shelters through sociotechnical imaginaries is in contrast to how innovative products have previously been studied. Rather than relying on “manifest success” (Bijker and Hughes, 2012) of shelters designed for humanitarian aid, where success in this context is measured in the ability of a shelter to reduce suffering, to provide increased safety to vulnerable people such as women and children, sociotechnical imaginaries unpack the black box of success to consider how personal dreams, aspirations, and goals of individual designers can mobilize into collected visions of their particular, articulations of desirable futures which may or may not align with real needs (Jasanoff, 2015; Bijker and Hughes, 2012).

## 2.0. METHODOLOGY

Sociotechnical imaginaries are present in the discourse between people and, as such, discourse-focused research methods engage this type of information. Discourse analysis also allows for a comparison and interpretation of data in a way that constantly reflects on the structure-agency relationship and ways that meaning making is constructed with narratives in the design community. A survey of the sociotechnical imaginaries within the culture of refugee emergency shelter needs both representative examples of various actors as well as a research approach to engage discourse without preconceptions. To attend to the former, three organizations or collectives were selected: 1) the United Nations High Commissioner for Refugees (UNHCR), 2) the IKEA Foundation and 3) their subsidiary, the Better Shelter RHU AB. For the latter, the inductive and systematic research method of grounded theory (GT) was used.

As imaginaries are emergent from social communities, it is important to not predetermine a theoretical structure. A discourse-focused research method that allows avoiding predetermining outcomes is grounded theory, a method centered on constant comparison (Glaser and Strauss, 1967; Chun Tie et al, 2019). The data-before-theory structure and a comparison model of grounded theory attempts to inductively discover or construct theory from data, which is systematically gathered and iteratively analyzed. Grounded theory was selected due to the lack of existing theories of the phenomenon of sociotechnical imaginaries of humanitarian design. As grounded theory attempts to generate theory that emerges through data analysis, it allows for the uncovering of processes to produce explanatory theories through evidence.

The research developed three corpora of text representative of the three collectives to be compared. The collections of documents were harvested from publicly available documents meant to represent the values of these groups to a larger population (BetterShelter.org; IKEAfoundation.org; UNHCR.org). Documents were identified due to the presence of keywords relating to refugee housing, for example “flat pack shelter”, “refugee housing”, and “shelter”. A representative sample of fifteen documents per collective were selected. Fifteen was considered acceptable for this study as, on preliminary review, there was evidence of redundancy of concepts within the three corpus groups.

The data was analyzed in Atlas.ti (version 9) allowing memos and codes to be generated through association with the text. Constant comparative analysis was employed during the coding and category development. This initial stage of analysis compared incident to incident in each code. Codes were then compared to other codes and then collapsed into categories. The process allowed the comparison of incidents in a category with previously identified incidents, either with the same or with different categories. The initial coding included several cycles, moving between memoing and framing emergent theory based on codes, to then reapply those codes into new data to validate those theories.

## 3.0. DISCUSSION AND OUTCOMES

The analysis of the corpus of three organizations include the Better Shelter, the IKEA Foundation, and the UNHCR to identify their respective roles in relation to the emergency shelter. The study is less concerned with the *object* of emergency shelters than it is with ideas of how the world should be and how we should or should not live (Jasanoff, 2004). Questions aligned with this intention were: What priorities have Better Shelter and the IKEA Foundation identified for design development of their emergency shelter? How does their latent biopolitical agenda differ from the UNHCR? What are the moments of shared agreement or tension in the imagined futures for refugees? In what way are desirable futures “institutionally stabilized, publicly performed” by each of the three major actors involved in the Better Shelter (Jasanoff, 2019, 6)?

The political structures of organizations as well as their aspirations and priorities affect physical product development. In turn, those physical products affect the political structure of the organization in a co-productive environment (Jasanoff, 2004). The Better Shelter, also known by the UNHCR as the Refugee Housing Unit (RHU) is such a product.



It was developed by a coalition of designers centered around IKEA, the Swedish furniture giant, and representative of that organization's distinguished involvement in humanitarian design. While there are personal dreams or aspirations of individual designers within the IKEA organization and its subsidiaries, the project, as a whole, forms as part of a shared agreement to the collected vision of the future. This shared vision focused on technological outcomes is a socio-technical imaginary and operates on the scale of groups rather than individuals.

### 3.1 The sociotechnical imaginaries of UNHCR

The corpus analysis showed that the UNHCR is focused on the immediate and long-term sheltering, independence, and capacity building for refugees. The UNHCR does not construct narratives that promote the use of one product but rather are interested in "Investing in R&D to innovate our shelter solutions and in modernizing our working methods to implement sustainable solutions to settlement and shelter problems" (UNHCR 2019). As world leaders in assessing and deploying humanitarian aid, the UNHCR manages to negotiate the functional relationship of social and material innovations into workable solutions to improve quality of life for refugees.

To address the complexities in the amount of time that a refugee might face during displacement, the UNHCR provides a multitude of material and social innovations for housing. They are not committed to a single strategy but adapt to the needs of situations and locations. For example, in Lebanon, the UNHCR have distributed "much needed weatherproofing and shelter kits to over 75,675 families" (UNHCR 2019), where materials such as "tarpaulin, plywood, lockable doors, insulation foam, and tools such as a saw, hammer and nails" are used to retrofit building not suitable for habitation (Nobody Left Outside, 2019). In Rwanda, a progressive and sustainable material solution was developed using hydra-formed, compressed mud bricks in lieu of regionally harvested wood. This innovative solution "provide[s] families with a robust, durable home that can last up to 7 years" (UNHCR 2019). In Lebanon where unfinished buildings are refugees' "only option for shelter" (UNHCR 2019), the UNHCR negotiated with landlords to reduce or eliminate rent in exchange for the UNHCR providing structural upgrades. A final example of how the UNHCR provides comprehensive social and material innovations to housing, in Iraq the UNHCR renovated thousands of unfinished buildings into habitable 'collective shelters' for families who have become displaced domestically. When the unfinished buildings require structural improvements, the UNHCR steps in to provide weatherproofing kits which address outstanding inadequacies in the shelter, making the spaces livable.

As evidenced in the corpus, the long-term goals of the UNHCR are to "continue modernizing working methods and implementing sustainable solutions to settlement and shelter problems that improve the wellbeing and dignity of refugees in a changing world" (UNHCR 2019). In specific locations, the Better Shelter is an appropriate selection for transitional refugee housing. The Better Shelter provides an upgrade from the UNHCR tent, but it is never referenced nor considered by the UNHCR to be an appropriate solution to all locations or situations.

In situations that are rapidly evolving or where weather threatens the comfort and safety of refugees, the rigid, waterproof and stab-proof exterior panels do provide significant protection for vulnerable people like women and children. The UNHCR has long term plans to invest in the Better Shelter, "to strengthen refugees' resilience to humanitarian crises and the impact of their displacement: continue supporting the deployment of the new version of the 'Refugee Housing Unit [Better Shelter]" (UNHCR 2019).

### 3.2 The sociotechnical imaginaries of IKEA Foundation and Better Shelter

There is a clear imaginary developed by the IKEA Foundation and Better Shelter as they desire to "bring dignity and safety to the millions of refugees fleeing violence, armed conflict, persecution and natural disasters" (IKEA Foundation and UNHCR ready to improve life, 2015). The corpus analysis shows that the IKEA Foundation and the Better Shelter rely on collectively understood cultural references to the imaginary which are supported by three concepts: 1) a sense of home 2) safety for vulnerable people and 3) dignity.

Specific use of language and imagery in press releases and internal documents solicit shared memories of families and children, evoking strong feelings of the necessity to protect vulnerable groups with the Better Shelter product. Safety and security for families with shelter is an undeniable concept tied to a sense of home. These concepts are carefully crafted to be relatable across cultures or demographics. In doing so, the corpus text also targets particular visions of the future. When IKEA frames its shelter as a response to "children's lives [being] turned upside down" and wanting "to make sure children have the chance to be children" or "How we're helping kids get their childhoods back" (IKEA Foundation, 2016b), they are constructing an imaginary that associates the designed technological and architectural product as a solution to a larger social issue of a families' emergency need for shelter.

The IKEA Foundation and Better Shelter also reference safety and dignity throughout their press releases with dignity being a by-product of safety in IKEA's rhetoric. It is the material innovation of the Better Shelter by which a refugee might live a more dignified life, and the material object is a promise. These two institutions use "safety and dignity" together often, to stabilize their constructed version of a sense of home for refugee families. Linking these concepts together also produces a rhetorical intention and indicates a value system. With a safer Better Shelter, your life will be more dignified than if you were in a more traditional emergency shelter, such as the tent or plastic sheeting.

The IKEA foundation has distinguished two major qualifiers of safety: safety from the elements, and personal safety during encampment. The efficacy of the Better Shelter to address personal safety is repeatedly highlighted with many references in the corpus to standards of personal control such as “the doors can be locked from both the inside and the outside, increasing security for residents” (Better Shelter. n.d.-a). The material composition of the Better Shelter, and the product it replaces provide a place that “refugee families and children can have a safer place to call home” (Better Shelter. n.d.-b).

These narratives also construct the basis for comparison between the Better Shelter and the product that the Swedish designers consistently push against – the UNHCR tent. According to the ideas and worldviews of the design teams who developed the innovative Better Shelter, it is in fact *Better Than a Tent*. This rhetoric is constantly present through various points from being “safer and more dignified than a tent” (Peters 2015) to having “an expected lifespan six times that of standard tents and at 17.5 square meters are much more spacious.” (Girardeau 2017) and “Unlike a tent, the shelters have lockable doors” (Peters 2015). As a positioning in the market, the intention is to remove the competition for, as IKEA states, “If you compare life in the tents and life in these shelters, it’s a thousand times better” (Wainwright 2017).

Better Shelter and IKEA see their product not as temporary but as a replacement for the home - a point that puts these imaginaries into conflict with the state temporary use of the shelter by the UNHCR. The designers envision the shelter through permanence through the narrative of home through statements such as “The tents offer little comfort or warmth and [...] [tents are] far from the ideal solution to a permanent home” (Girardeau 2017) and “It feels more like a house” (Peters 2015). These narratives of safety, home, and dignity become methods of construction of sociotechnical imaginaries which link design innovation as a crucial, necessary tool for building a brighter future - in this case, how life will improve for refugees. The value of Better Shelter, understood as its ability to “fix” problems like lack of safety, lack of dignity, emerges from the belief system that the IKEA Foundation and Better Shelter are providing essential and comprehensive solutions to the hardships faced during encampment.

### 3.3 Co-production, Needs and Power

The IKEA Foundation and Better Shelter assesses the needs and priorities of refugees by “gather[ing] input from the families testing the shelter” (IKEA Foundation 2013). During the design development of the shelter, the IKEA Foundation noted that “the refugee families who would be making the shelter their homes will have a direct say in how the product is developed, putting their experience at the heart of this collaborative process” (IKEA Foundation 2013). The exact number of refugees and extent of their involvement is unclear. However, the IKEA Foundation identifies this exchange of values between refugees and Better Shelter designers as “democratic design” (Better Shelter. N.d.-b; IKEA Foundation 2015b; IKEA Foundation 2016a).

Democratic design is defined by the IKEA Foundation in many ways in the corpus, typically consistent with “an innovative approach to designing for refugees and putting their needs at the heart of the development process” (IKEA Foundation 2013) but also diverging into concepts of “form, function, quality, and an affordable price” (IKEA Foundation 2015a). Considering these definitions of democratic design, the Better Shelter can be understood as a co-produced technology, where social practices, identities, norms, conventions, discourses of refugees and the designers are embedded in the material component of the Better Shelter (Jasanoff 2004).

However, co-production in practice suffers from the same shortcomings as it does in theory. While co-production provides access to understand the assemblage of events, people, and values that shape technology, it does not explicitly deal with issues of power (Jasanoff, 2015). Co-production considers the hierarchy of the participants as flat, where one participant's values, opinions or needs do not have more weight than others. While the IKEA Foundation consulted with refugees during the design development phase, the geolocation of the IKEA Foundation, its intellectual property around manufacturing, Western intellectual orientation, market driven logistic strategies, and Swedish design aesthetic all arguably have more weight than the feedback provided by refugees, as evidenced in the various media points focused on ease of shipping, speed of assembly and relatively low-cost for a ‘home’ (IKEA Foundation 2012, 2015a, 2017). Perhaps more interesting, the Better Shelter’s cultural image expressed in its material form is one of a little Swedish house as well as resembling the standard aesthetic of a piece of IKEA furniture.

The packing and shipping logistics of the IKEA Foundation, one of the main market differentiators and core intellectual property of the IKEA furniture company, is a curious point of entry to critique democratic design and its relationship to co-production. The IKEA Foundation offers another definition of democratic design which differs from the narrative of consulting with refugees. This definition is “to create better everyday lives for refugee children and families,” (IKEA Foundation 2016a) which should be lauded as compassionate. However, the same approach addressing the refugee and humanitarian crisis is the core business model of IKEA where “At IKEA our vision is to create a better everyday life for the many people” (IKEA n.d.). While it seems innocuous, this is a language of power and the assertion of dominance through a “blatant use of power” (Jasanoff 2015) of a for-profit company with a philanthropic arm to leverage commercial market position and technology in *exactly the same way* to a new market - humanitarian aid.

According to the UNHCR, social progress is more nuanced and less internally vested in profiteering (UNHCR 2015c). Their long-term goals are to “continue modernizing working methods and implementing sustainable solutions to settlement and shelter problems that improve the wellbeing and dignity of refugees in a changing world” (UNHCR 2019). Unlike the market positioning of the IKEA Foundation, which uses the same language of the for-profit IKEA organization, the UNHCR does not construct narratives that promote the use of one product or compare products in a way that prioritizes one over another, such as the Better Shelter being “a thousand times better” than a tent (Wainwright 2017). Rather, innovations in material architectural products are part of a much larger social strategy where “Investing in R&D to innovate our shelter solutions and in modernizing our working methods to implement sustainable solutions to settlement and shelter problems” (UNHCR 2019).

## CONCLUSION

When addressing sociotechnical imaginaries in designed outcomes, it is not necessary to be exclusive to one vision or require imaginaries to be homogeneous. Rather “multiple imaginaries can coexist within a society in tension or in a productive dialectical relationship” (Jasanoff 2019, 5). However, making decisions for future outcomes is the core process of a design action and this requires the resolution between conflicting positions. This means to “elevate some imagined futures above others” (Jasanoff 2019, 5) through legal or rhetorical societal mechanisms.

The Better Shelter, as part of an imaginary, cannot be defined only by its material components and their promise to improve quality of life. The promise to do future good is durable and dominant because it encodes what is possible with technology in a co-productive relationship. However, there needs to be recognition of power differentials and nuanced understanding of values. The sociotechnical imaginaries of the IKEA Foundation and Better Shelter are that safety, happiness, and dignity are portable. They are goods that can be packed and shipped flat and consumed by refugees. IKEA clearly is committed to social entrepreneurship through its foundation which is aligned with its core technology and business strategies, which is not inherently negative. In addition, both IKEA, through Better Shelter and the IKEA Foundation, and the UNHCR are concerned with social progress. However, there is a clear difference in the position of IKEA as a for-profit and private company applying market strategies to build capacity for use, and thus market dominance, of its humanitarian “solution”. The sociotechnical imaginary of the UNHCR, in contrast, is not embedded in one material product but rather is housed in a palette of material sheltering options and social innovations focused on attending to emergency sheltering needs in different locations, with context specific strategies. When possible, the UNHCR employs local materials, existing buildings, or material innovations that are sustainable.

It must be recognized that the Better Shelter is a well-considered (i.e., designed) architectural product to help address real needs around the world. It is desirable because it is “grounded in positive visions of social progress” (Jasanoff 2015) but it is not, nor should not be, the only solution to a complex situation. IKEA’s rhetoric would have us believe it is utopia delivered, with a manual, in two boxes.

## REFERENCES

### Research Corpus

#### *Better Shelter*

- Better Shelter. n.d.-a "Press Release: UNHCR and Better Shelter Extend Agreement on the Provision of Temporary Housing for Refugees." Better Shelter., accessed December 16, 2020, <https://bettershelter.org/press-release-unhcr-and-better-shelter-extend-agreement-on-the-provision-of-temporary-housing-for-refugees/#:~:text=Products-Press%20Release%3A%20UNHCR%20and%20Better%20Shelter%20extend%20agreement%20on%20the,of%20people%20forced%20to%20flee.>
- Better Shelter. n.d.-b "UNHCR Signs for 10,000 Flat-Pack Shelters." Better Shelter., accessed December 16, 2020, <https://bettershelter.org/press/unhcr-signs-for-10000-flat-pack-shelters/>.
- Better Shelter. n.d.-c "Virgin Unite: Closing the Flat-Pack Door on Climate Change." Better Shelter., accessed December 16, 2020, <https://bettershelter.org/news-post/virgin-unite-closing-the-flat-pack-door-on-climate-change/>.
- Better Shelter. 2017. "Flat-Pack Refugee Shelter Wins Design of the Year 2016." Ikea Foundation., last modified January 30, accessed December 16, 2020, <https://ikeafoundation.org/story/flat-pack-refugee-shelter-wins-design-of-the-year-2016>.
- Alleyne, Allyssia. 2017. "Ikea Flat-Pack Refugee Shelter Named 2016 Design of the Year." CNN., last modified January 29, accessed December 16, 2020, <https://www.cnn.com/style/article/design-of-the-year-2016-ikea-refugee-shelter/index.htm>.
- Dearden, Lizzie. 2015. "Ikea's Flat Pack Refugee Shelters Housing Thousands of Desperate Families Across Europe as Winter Closes In." Independent., accessed December 16, 2020, <https://www.independent.co.uk/news/world/europe/ikea-s-flat-pack-refugee-shelters-housing-thousands-desperate-families-across-europe-winter-closes-a6752576.html>.
- Dundas, Mairead. 2014. "Down to Earth - Flat-Pack Shelters for Syrian Refugees." France 24., last modified -03-16T20:15:55+00:00, accessed December 16, 2020, <https://www.france24.com/en/20140316-down-to-earth-iraq-syrian-refugees-emergency-shelters-unhcr-ikea>.
- Girardeau, Max. 2017. "Social Enterprise Flat Packs Revolutionise Refugee Camp Shelter." Pioneers Post., last modified January 4, accessed December 16, 2020, <https://www.pioneerspost.com/news-views/20160104/social-enterprise-flat-packs-revolutionise-refugee-camp-shelter>.

- Peters, Adele. 2015. "Ikea and Better Shelter are Sending Flat-Pack Housing to Refugees in Greece." *Fast Company*., last modified -12-14T08:10:00, accessed December 16, 2020, <https://www.fastcompany.com/3054422/ikea-and-better-shelter-are-sending-flat-pack-housing-to-refugees-in-greece>.
- Purtill, Corinne. 2015. "The Ikea-Backed Company Making Flat-Pack Refugee Shelters Can't Keep Up with Demand." *Quartz*., last modified October 1, accessed December 16, 2020, <https://qz.com/515169/the-ikea-backed-company-making-flat-pack-refugee-shelters-cant-keep-up-with-demand/>.
- Torche, Trushna. 2020. "PAKISTAN: Aga Khan Development Network and Better Shelter Build Covid-19 Rapid Response Centres." *Better Shelter*., last modified June 11, accessed 12/16/, 2020, <https://bettershelter.org/pakistan-akdn-and-better-shelter-build-covid-19-rapid-response-centres/>.
- Wainwright, Oliver. 2017. "Why Ikea's Flatpack Refugee Shelter Won Design of the Year." *The Guardian*., last modified January 27, T13:55:38.000Z, accessed December 16, 2020, <http://www.theguardian.com/artanddesign/2017/jan/27/why-ikea-flatpack-refugee-shelter-won-design-of-the-year>.
- Xie, Jenny. 2015. "Thousands of Ikea Flatpack Shelters have Gone to Syrian Refugees in 2015." *Curbed*., last modified -12-02T16:30:00-05:00, accessed December 16, 2020, <https://archive.curbed.com/2015/12/2/9894848/syrian-refugees-housing-ikea-shelters>.
- IKEA Foundation*
- IKEA Foundation, 2012. "IKEA Flat Pack Solutions are Making a Big Difference to Refugees." *IKEA Foundation*., last modified June 20, accessed December 16, 2020, <https://ikeafoundation.org/story/ikea-flat-pack-solutions-are-making-a-big-difference-to-refugees/>.
- IKEA Foundation. 2013. "Designing a Better Home for Refugee Children." *IKEA Foundation*., last modified June 20, accessed December 16, 2020, <https://ikeafoundation.org/story/designing-a-better-home-for-refugee-children/>.
- IKEA Foundation. 2015a. "Better Shelter, IKEA Foundation and UNHCR Ready to Improve Life for Thousands of Refugee Families." *IKEA Foundation*., last modified March 24, accessed December 16, 2020, <https://ikeafoundation.org/press-release/better-shelter-ikea-foundation-and-unhcr-ready-to-improve-life-for-thousands-of-refugee-families/>.
- IKEA Foundation, 2015b. "Thousands of Refugee Children Will Soon have Safer Homes." *IKEA Foundation*., last modified March 24, accessed December 16, 2020, <https://ikeafoundation.org/story/thousands-of-refugee-children-will-soon-have-safer-homes/>.
- IKEA Foundation, 2016a. "How Business and Philanthropy can Take a Lead in Responding to Humanitarian and Refugee Crises." *IKEA Foundation*., last modified August 19, accessed December 16, 2020, <https://ikeafoundation.org/press-release/how-business-and-philanthropy-can-take-a-lead-in-responding-to-humanitarian-and-refugee-crises/>.
- IKEA Foundation, 2016b. "How We're Helping Kids Get Their Childhoods Back." *IKEA Foundation*., last modified August 19, accessed December 16, 2020, <https://ikeafoundation.org/story/how-were-helping-kids-get-their-childhoods-back/>.
- IKEA Foundation, 2016c. "What Design can do: Refugee Challenge Receives Over 600 Entries from 69 Countries." *IKEA Foundation*., last modified June 14, accessed December 16, 2020, <https://ikeafoundation.org/press-release/what-design-can-do-refugee-challenge-receives-over-600-entries-from-69-countries/>.
- IKEA Foundation, 2016d. "What Design can do: UNHCR and IKEA Foundation Launch Global Design Challenge Focusing on Refugees." *IKEA Foundation*., last modified February 19, accessed December 16, 2020, <https://ikeafoundation.org/press-release/what-design-can-do-unhcr-and-ikea-foundation-launch-global-design-challenge-focusing-on-refugees/>.
- IKEA Foundation, 2017. "Flat-Pack Refugee Shelter Wins Design of the Year 2016." *IKEA Foundation*., last modified January 30, accessed December 16, 2020, <https://ikeafoundation.org/story/flat-pack-refugee-shelter-wins-design-of-the-year-2016/>.
- United Nations High Commissioner for Refugees*
- UNHCR. n.d. "Refugee Housing Unit." *UNHCR*., accessed December 16, 2020, <https://www.unhcr.org/refugee-housing-unit.html>.
- UNHCR. 2005. "Refugee Livelihoods, RLN Summer 2005." *UNHCR*., last modified August 1, accessed December 16, 2020, <https://www.unhcr.org/research/eval/434d26e22/refugee-livelihoods-rln-summer-2005.html>.
- UNHCR. 2015a. "Innovative Shelter Solutions through Research and Development." *UNHCR*., last modified November 3, accessed December 16, 2020, <https://www.unhcr.org/protection/basic/5638cc0b9/innovative-shelter-solutions-research-development.html>.
- UNHCR. 2015b. "Lesvos Island - Greece Factsheet." *UNHCR*., last modified November 12, accessed December 16, 2020, <https://data2.unhcr.org/en/documents/details/46447>.
- UNHCR. 2015c. "UNHCR Global Appeal 2015 Update: Mobilizing the Private Sector." *UNHCR. United Nations High Commissioner for Refugees*, accessed December 16, 2020, <https://www.unhcr.org/en-us/publications/fundraising/5461e5f1553/unhcr-global-appeal-2015-update-mobilizing-private-sector.html>.
- UNHCR. 2018a. "Refugee Housing Unit - Fact Sheet." *UNHCR. UNHCR*, last modified December 12, accessed December 16, 2020, <https://www.unhcr.org/getinvolved/fundraising/5c1127d24/refugee-housing-unit-fact-sheet.html>.
- UNHCR. 2018b. "Two Years of Shelter Activities." *UNHCR. United Nations Higher Commissioner for Refugees*, last modified December 12, accessed Jan 17, 2021, <https://www.unhcr.org/getinvolved/fundraising/5c1129684/two-years-of-shelter-activities.html>.
- UNHCR. 2019. "30 Months Update - Global Shelter Coalition." *UNHCR. United Nations Higher Commissioner for Refugees*, last modified December, accessed December 16, 2020, <https://www.unhcr.org/getinvolved/fundraising/5dfb5b0e7/30-months-update-global-shelter-coalition.html>.
- General references*
- IKEA. n.d. "Our Business Idea", accessed Jan 3, 2021, [https://www.ikea.com/ms/en\\_JP/about\\_ikea/the\\_ikea\\_way/our\\_business\\_idea/index.html](https://www.ikea.com/ms/en_JP/about_ikea/the_ikea_way/our_business_idea/index.html)
- UNHCR. n.d. "Who we Help.", accessed Jan 17, 2021, <https://www.unhcr.org/who-we-help.html>.
- Auger, James. 2013. "Speculative Design: Crafting the Speculation." *Null* 24 (1): 11-35. doi:10.1080/14626268.2013.767276. <https://doi.org/10.1080/14626268.2013.767276>.

- Bijker, Wiebe E. and Deborah G. Douglas. 2012. "The Social Construction of Bakelite:; Toward a Theory of Invention." In *The Social Construction of Technological Systems*, edited by Wiebe E. Bijker, Thomas P. Hughes and Trevor Pinch, 155-182: The MIT Press. doi:10.2307/j.ctt5vjrsq.14. <http://www.jstor.org/stable/j.ctt5vjrsq.14>.
- Bodewitz, Henk J. H. W., Henk Buurma, Gerard H. de Vries, and Deborah G. Douglas. 2012. "Regulatory Science and the Social Management of Trust in Medicine." In *The Social Construction of Technological Systems*, edited by Wiebe E. Bijker, Thomas P. Hughes and Trevor Pinch, 237-252: The MIT Press. doi:10.2307/j.ctt5vjrsq.18. <http://www.jstor.org/stable/j.ctt5vjrsq.18>.
- Callon, Michel and Deborah G. Douglas. 2012. "Society in the Making:; The Study of Technology as a Tool for Sociological Analysis." In *The Social Construction of Technological Systems*, edited by Wiebe E. Bijker, Thomas P. Hughes and Trevor Pinch, 77-98: The MIT Press. doi:10.2307/j.ctt5vjrsq.10. <http://www.jstor.org/stable/j.ctt5vjrsq.10>.
- Collins, H. M. and Deborah G. Douglas. 2012. "Expert Systems and the Science of Knowledge." In *The Social Construction of Technological Systems*, edited by Wiebe E. Bijker, Thomas P. Hughes and Trevor Pinch, 321-340: The MIT Press. doi:10.2307/j.ctt5vjrsq.23. <http://www.jstor.org/stable/j.ctt5vjrsq.23>.
- Constant, Edward W. and Deborah G. Douglas. 2012. "The Social Locus of Technological Practice:; Community, System, Or Organization?" In *The Social Construction of Technological Systems*, edited by Wiebe E. Bijker, Thomas P. Hughes and Trevor Pinch, 217-236: The MIT Press. doi:10.2307/j.ctt5vjrsq.17. <http://www.jstor.org/stable/j.ctt5vjrsq.17>.
- Cowan, Ruth Schwartz and Deborah G. Douglas. 2012. "The Consumption Junction:; A Proposal for Research Strategies in the Sociology of Technology." In *The Social Construction of Technological Systems*, edited by Wiebe E. Bijker, Thomas P. Hughes and Trevor Pinch, 253-272: The MIT Press. doi:10.2307/j.ctt5vjrsq.19. <http://www.jstor.org/stable/j.ctt5vjrsq.19>.
- Douglas, Deborah G. 2012. "Introduction." In *The Social Construction of Technological Systems*, edited by Wiebe E. Bijker, Thomas P. Hughes and Trevor Pinch, 299-302: The MIT Press. doi:10.2307/j.ctt5vjrsq.21. <http://www.jstor.org/stable/j.ctt5vjrsq.21>.
- Foucault, Michel. 1979. *Discipline and Punish*. New York: Vintage.
- Hacking, Ian. 1999. *The Social Construction of what?*. Cambridge, Mass.: Harvard University Press.
- Hales, Derek. 2013. "Design Fictions an Introduction and Provisional Taxonomy." *Null* 24 (1): 1-10. doi:10.1080/14626268.2013.769453. <https://doi.org/10.1080/14626268.2013.769453>.
- Hughes, Thomas P. and Deborah G. Douglas. 2012. "The Evolution of Large Technological Systems." In *The Social Construction of Technological Systems*, edited by Thomas P. Hughes, Wiebe E. Bijker and Trevor Pinch, 45-76: The MIT Press. doi:10.2307/j.ctt5vjrsq.9. <http://www.jstor.org/stable/j.ctt5vjrsq.9>.
- Jasanoff, Sheila. 2019. "Sociotechnical Imaginaries." *Journal of Chemical Information and Modeling* 53 (9): 1689-1699.
- Jasanoff, Sheila and Sang-Hyun Kim. 2015. *Dreamscapes of Modernity : Sociotechnical Imaginaries and the Fabrication of Power*. Chicago; London: The University of Chicago Press.
- Jasanoff, Sheila, Kim, Sang-Hyun and Sperling, Stefan. "Sociotechnical Imaginaries and Science and Technology Policy: A Cross-National Comparison.", last modified August, accessed December 28, 2020, <https://www.researchgate.net/deref/http%3A%2F%2Fstsprogram.org%2Fadmin%2Ffiles%2Fimaginaries%2FNSF-imaginaries-proposal.pdf>.
- Law, John and Deborah G. Douglas. 2012. "Technology and Heterogeneous Engineering:; The Case of Portuguese Expansion." In *The Social Construction of Technological Systems*, edited by Wiebe E. Bijker, Thomas P. Hughes and Trevor Pinch, 105-128: The MIT Press. doi:10.2307/j.ctt5vjrsq.12. <http://www.jstor.org/stable/j.ctt5vjrsq.12>.
- MacKenzie, Donald and Deborah G. Douglas. 2012. "Missile Accuracy:; A Case Study in the Social Processes of Technological Change." In *The Social Construction of Technological Systems*, edited by Wiebe E. Bijker, Thomas P. Hughes and Trevor Pinch, 189-216: The MIT Press. doi:10.2307/j.ctt5vjrsq.16. <http://www.jstor.org/stable/j.ctt5vjrsq.16>.
- Miller, Clark A. and Ira Bennett. 2008. "Thinking Longer Term about Technology: Is there Value in Science Fiction-Inspired Approaches to Constructing Futures?" *Science and Public Policy* 35 (8) (01 October): 597-606. doi:<https://doi.org/10.3152/030234208X370666>.
- Miller, Clark A. and Tischa A. Muñoz-Erickson. 2018. *The Rightful Place of Science: Designing Knowledge*. Charleston, South Carolina: Consortium for Science, Policy & Outcomes.
- Pinch, Trevor J., Wiebe E. Bijker, and Deborah G. Douglas. 2012. "The Social Construction of Facts and Artifacts:; Or how the Sociology of Science and the Sociology of Technology might Benefit each Other." In *The Social Construction of Technological Systems*, edited by Wiebe E. Bijker, Thomas P. Hughes and Trevor Pinch, 11-44: The MIT Press. doi:10.2307/j.ctt5vjrsq.8. <http://www.jstor.org/stable/j.ctt5vjrsq.8>.
- Scott-Smith, Tom. 2019. "Beyond the Boxes." *American Ethnologist* 46 (4): 509-521. Doi: <https://doi.org/10.1111/amet.12833>. <https://doi.org/10.1111/amet.12833>.
- Seferiadis, Anastasia A., Sarah Cummings, Marjolein B. M. Zweekhorst, and Joske F. G. Bunders. 2015. "Producing Social Capital as a Development Strategy: Implications at the Micro-Level." *Progress in Development Studies* 15 (2): 170-185. doi:10.1177/1464993414565530. <https://doi.org/10.1177/1464993414565530>.
- van den Belt, Henk, Arie Rip, and Deborah G. Douglas. 2012. "The Nelson-Winter-Dosi Model and Synthetic Dye Chemistry." In *The Social Construction of Technological Systems*, edited by Wiebe E. Bijker, Thomas P. Hughes and Trevor Pinch, 129-154: The MIT Press. doi:10.2307/j.ctt5vjrsq.13. <http://www.jstor.org/stable/j.ctt5vjrsq.13>.
- Woolgar, Steve and Deborah G. Douglas. 2012. "Reconstructing Man and Machine:; A Note on Sociological Critiques of Cognitivism." In *The Social Construction of Technological Systems*, edited by Wiebe E. Bijker, Thomas P. Hughes and Trevor Pinch, 303-320: The MIT Press. doi:10.2307/j.ctt5vjrsq.22. <http://www.jstor.org/stable/j.ctt5vjrsq.22>.
- Yoxen, Edward and Deborah G. Douglas. 2012. "Seeing with Sound:; A Study of the Development of Medical Images." In *The Social Construction of Technological Systems*, edited by Wiebe E. Bijker, Thomas P. Hughes and Trevor Pinch, 273-296: The MIT Press. doi:10.2307/j.ctt5vjrsq.20. <http://www.jstor.org/stable/j.ctt5vjrsq.20>.



# Evidence-based Health Centre Design Recommendations for the Malawi Ministry of Health

Chris Harnish<sup>1</sup>, Anthony Elia<sup>1</sup>, Josh Harmony<sup>1</sup>

<sup>1</sup>Thomas Jefferson University, Philadelphia, PA

**ABSTRACT:** In Malawi, burgeoning demand for public health infrastructure raises significant planning, design, implementation, and resilience challenges for the Republic of Malawi Ministry of Health (MOH). As the MOH plans a new health centre prototype, it is essential to consider evidence-based performance goals addressing user-focused programming, infection control, and energy and water infrastructure in a context of limited resources, global pandemics, and climate change. Malawi's health centers are the initial point of care for 90% of the population. By 2050 the population will nearly double from 18 to 36 million. Despite this tremendous growth, 68% of Malawians will continue to live in rural areas, far from centralized and higher levels of health infrastructure in urban contexts. Concurrently, the national demand for electricity will more than double projected supply, and water resources will become more scarce. This architectural research examines the existing MOH health centre prototype, identifies evidence-based design gaps relative to medical literature and architectural performance analysis, and makes recommendations for a new Health Centre model for the MOH and related stakeholders to consider.

In collaboration with the MOH, Department of Buildings, University of Malawi The Polytechnic and the College of Medicine we define the most pressing problems that will inform evidence-based architectural guidelines. The research methodology examines four main criteria for design assessment: user-focused programming for patients and staff, infection control, and infrastructure resilience. The research begins with a systematic literature review, followed by user interviews, and architectural evaluation of the existing MOH prototype. Analysis of recently built health centres in similar contexts highlight alternative design options. Findings inform human-resource strategic, environmentally resilient, user-focused design recommendations for health centres in Malawi and similar low and middle-income countries (LMICs). Design recommendations are shared with key stakeholders for input and are currently under evaluation and incorporation into a new health centre model for the MOH as it plans to build the next 100 centres.

**KEYWORDS:** Health infrastructure, Malawi, evidence-based design, energy and water resilience, architecture

## 1.0 INTRODUCTION + RATIONALE FOR WORK

In Malawi, new Republic of Malawi Ministry of Health (MOH) primary health centre design guidelines are essential to respond to design shortcomings identified in recent medical literature: infection control strategies, patient quality of care, staff satisfaction and performance. Furthermore, the emerging scarcity of energy and water resources heightens the importance of resilience strategies in a context of rapid population growth and limited human and economic resources.

By 2050, Malawi's population is expected to nearly double (United Nations, DESA, Population Division 2018), due to high fertility and increasing life expectancy rates (United Nations Statistics Division 2019). Despite this growth, 68% of Malawians will continue to live in rural areas far from concentrated nodes of health infrastructure (Government of the Republic of Malawi 2017). These rural contexts are primarily served by health centres with programs including outpatient services, vaccinations, pediatric care, low-risk maternity/OBGYN, and referral to higher tier hospitals. The MOH Health Sector Strategic Plan (HSSP) intends for one health centre per 10,000 citizens however the current ratio is 1:42,000. To achieve the goal of one Health Centre per 10,000 citizens, the MOH will need to construct more than 350 health centres in the coming years, spread broadly across the country (Government of the Republic of Malawi 2017).

A more effective and resilient health centre design can positively impact the lives of millions of Malawi's citizens. Given the critical need for health centres in the country and the emerging challenges that necessitate new design criteria, the following objectives were examined to inform new design outcomes.

### 1.1 User-focus: the need to improve staff retention and satisfaction

In rural contexts in particular, human resource scarcity and retention are significant challenges to the MOH (Merriel, Hussein, Malata, Coomarasamy, & Larkin 2018). Staff shortages hinder intended levels of care, and quality of care



(QOC) perceptions from patients. One key rationale Staff cite for leaving rural MOH facilities is inadequate architectural infrastructure (Chimwaza, et al. 2014).

### **1.2 User-focus: the need to improve patient quality of care**

Literature reveals inadequate architecture can negatively impact patient QOC, while user-responsive architectural designs can improve QOC (Chimwaza, et al. 2014). Improved spatial organization can reduce worker inefficiency directly linked to improved patient satisfaction (Rothe, Schlaich, & Thompson 2013). Spatial organization to increase visual acuity between patients and staff improve patient satisfaction (Schmiedeknecht, et al. 2015).

### **1.3 Nosocomial infection: the need to strengthen infection control measures**

Strategic spatial programming and architectural assemblies can improve infection control and protect patients and health care workers (Cronk & Bartram 2018), an issue only heightened by the COVID-19 pandemic (Anderson, et al. 2020). Typically, tuberculosis infection is the metric used to measure worker nosocomial airborne infection in sub-Saharan Africa. Data reveals increased TB rates among healthcare workers in facilities with TB treatment, pointing to nosocomial infection as the cause (Flick, et al. 2017). Other transmissible infections including *Klebsiella pneumoniae*, Hepatitis B, and diarrhoeal diseases are also prevalent within health care facilities (Rothe, Schlaich, & Thompson 2013). In Malawi's typically passively ventilated health centres, well-ventilated patient areas and sequestering patient populations can protect patients and staff from highly infectious airborne disease transmission (World Health Organization 2020). Design methods that include these infection control protocols are now required for future health infrastructure planning in most contexts (Flick, et al. 2017).

### **1.4 Resilience: the need to improve energy and water infrastructure**

Changing climate and rapidly increasing national demand on energy and water infrastructure heighten the current fact that most MOH health centres lack adequate, reliable power and water resources, detrimental to infection control measures, QOC, and staff satisfaction (Reuland, et al. 2020). Fewer than half of MOH health care facilities include consistent electricity (Reuland, et al. 2020; Suhlrie, et al. 2018). Access to reliable water sources is cited as a limitation of adequate sanitation, handwashing hygiene and related infection control measures (Anderson, et al. 2020).

## **2.0 METHODS**

### **2.1 Systematic literature review**

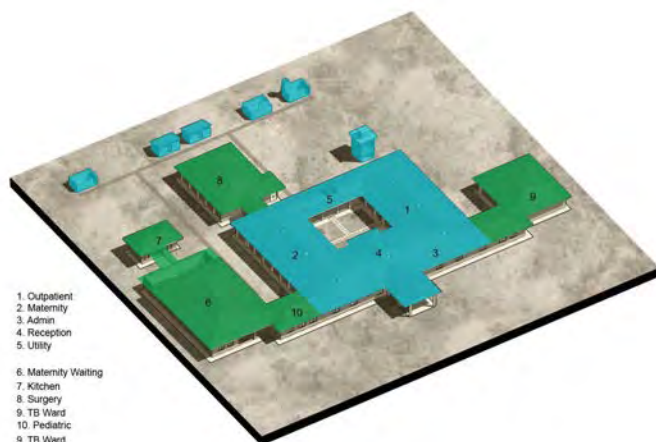
The research began with a systematic literature review of the PubMed database on articles from 2010 to the present to inform critical staff and patient indicators informed by the built environment. The review contained search terms relating to Malawi and LMICs, hospitals and the built environment, infection control, patient and staff satisfaction, and infrastructure. Following this review architectural literature and medical journals were studied to identify design interventions based on evidence-based design (EBD), best practices, and international guidelines. The literature review sought programmatic design considerations related to staff retention and satisfaction, patient QOC, infection control, and off-the-grid energy and water systems.

### **2.2 Analysis of existing prototype**

An analysis of the existing MOH health centre prototype followed (Fig. 1), wherein a comparative analysis with the preceding literature review determined successes and gaps in the current design. A recently constructed health centre in the Kasungu District aligns with the standard MOH template, which was surveyed and documented to establish a baseline analysis. Digital models were created in Rhinoceros 3D to simulate building assemblies, then Ladybug and Honeybee climate analysis software was used to simulate annual weather patterns and their effects on the model. This analysis additionally considered capacity for off-the-grid energy and water infrastructure, daylighting, ventilation, and other architectural factors that may impact the objectives.

### **2.3 Comparative case study analysis**

Architectural case studies of various health centres in similar architectural, programmatic, and climatic contexts were examined. Including two projects from ASA Studio based in Rwanda: the Kintobo, and Rugerero, health centres (see Fig. 3 & 4). This evaluation considered circulation, programmatic efficiency, ventilation related infection control, indoor-outdoor relationships, and energy and water performance.



**Figure 1:** MOH Model Health Centre Plan - showing as built conditions in blue, remaining build out in green

## 2.4 Stakeholder interviews

A series of design recommendations were then developed and evaluated by stakeholders at the MOH. Interviews were held at the district health centre, and with Ministry of Health officials. Each evaluated relevant topics from the literature review and design analysis. Their contributions informed deficiencies in the existing model and provided insights to future design considerations. For this preliminary evaluation, patients were not surveyed due to ethical approval and privacy considerations.

## 3.0 FINDINGS

The results of the literature review and architectural analysis reveal multiple key factors to inform the design process of a new MOH model, organized by topical consideration.

### 3.1 Overview: existing MOH prototype

The existing MOH health center prototype consists of seven modules. A courtyard cluster of four nodes includes the primary programming: waiting/registration, maternity, outpatient, and administration. Peripheral nodes encompass the courtyard, and include secondary programming not necessarily included at all facilities: tuberculosis treatment, surgery, maternity waiting dormitory housing, waste management and ablution blocks (Fig. 1). Initial program blocks can be built to serve existing demands, with additional modules easily added as future planning and funding dictate. The rectangular forms are typical masonry wall assemblies (CMU, brick, or soil-stabilized block) on concrete turn-down slab footings, with timber or light metal trusses supporting hipped-gable roofs of metal roof sheeting. Typically, each small room has one window on regularized modules, and solid walls with single leaf doors separating rooms from an interior double-loaded corridor (Fig. 2).

### 3.2 Users: patient satisfaction and quality of care

The literature review revealed limited research directly linking patient satisfaction and the built environment in LMIC settings. However, given evidence of long wait times and crowding, the architectural factors which may inform such patient satisfaction is an area of vital study. Patient QOC is often indicated by health worker contact time and patient waiting times. On average, adults wait 108 minutes to see a provider while children wait up to 133 minutes; both groups see up to three care providers per visit. This is compared with an average of only 2 minutes of health worker contact, regardless of time of day or day of the week (Jafry, et al. 2016).

At the MOH facility, a small covered exterior waiting area with concrete bench seating for all patients, is surrounded by circulation routes and consistent foot traffic. Elderly and pediatric patients, infants and mothers, are confined in close proximity. An internal narrow double loaded corridor acts as a waiting area immediately prior to examination, where patients and staff have frequent and overlapping circulation routes. Human congestion combined with long waiting times in these areas likely has a negative impact on overall quality of care. The courtyard is not used for patient waiting or staff retreat.

### 3.3 Users: human resource efficiency

Human resource related findings reveal that strenuous walking distances, inadequate lighting and noise levels, cumbersome unit configuration limit to staff effectiveness (Chaudhury, Mahmood, & Valente 2009). While improved spatial configuration resulted in an increase of time spent with patients and family members, the key indicator of patient satisfaction (Hendrich, et. al. 2009).

Analysis of the existing MOH scheme reveals separate building forms leading to high travel distances for staff moving between the program blocks. The long rectangular blocks increase distance from patients to staff relative to square or round forms. Daylighting analysis shows small window sizes do not daylight the rooms to adequate levels for worker comfort, requiring electrical lighting or creating a straining work environment. Interviews with staff corroborated the concerns found in the literature.

### **3.4 Users: human resource satisfaction**

Literature suggests stress levels can be reduced by more effective health facility design. Staff retention is a significant challenge of the MOH and is cited in the HSSP as a major concern to be addressed. While the built environment alone cannot solve this issue, it can respond by reducing strain on healthcare staff and providing a more efficient and pleasing context in which to work (Merriel, Hussein, Malata, Coomarasamy, & Larkin 2018). Architectural characteristics should include connection to nature, architectural options and choices including various circulation routes and unique nodes, social support spaces, pleasant diversions, and the elimination of environmental stressors (Ulrich 1991). Furthermore, adequate housing with reliable energy and water was cited as a motivating factor for MOH staff. (Kasenga & Hurtig 2014)

The existing MOH template lacks areas for staff to retreat to outside of patient realms where stress levels can decrease. The courtyard provides the opportunity for natural connections, but the double loaded corridors and proximity of patient waiting areas renders the courtyard ineffective for connections to nature and staff (or patient) social support spaces (Fig. 2). Interviews with staff corroborated the concerns found in the literature.

### **3.5 Nosocomial infection control: patient screening and sequestration**

WHO guidelines recommend exterior screening areas at all health infrastructure facilities in contexts of high potential exposure, including patient social distancing prior to screening, the isolation of potentially contagious patients after screening, and strategies to significantly isolate contagious patients throughout (WHO 2020). The current MOH model lacks sufficient areas at facility entrances to manage and isolate patient populations prior to screening for infectious disease. Although initial waiting areas are outdoors; patients circulate into narrow double-loaded corridors and wait for extended periods in groups adjacent to treatment and consultation rooms. The scale of the space is not sufficient for screening and sequestration. These critical nodes in the circulation sequence lack proper ventilation, inhibit social distancing, and threaten worker and patient safety.

### **3.6 Nosocomial infection control: natural ventilation**

Nosocomial infection concerns have long been a design consideration across health infrastructure in passively ventilated contexts. In Malawi, single-story, slender, and well-spaced buildings are accordingly the norm. A study conducted in 2007 describes the advantages of improved natural ventilation regarding the spread of nosocomial infection. A drug resistant TB strain was suspected to be spread via nosocomial transmission, with a projected model that estimated up to 50% of future cases would be similarly spread. Improved natural ventilation averted an estimated 33% of cases (Rothe, Schlaich, & Thompson 2013).

The WHO has established guidelines for different programmatic spaces in health infrastructure, with recommended air change per hour (ACH) guidelines. Minimum ventilation in healthcare settings ranges from 10 ACH for corridors and up to 12 for areas such as waiting areas and rooms used by potentially infectious patients (WHO 2009). Digital modelling analysis shows multiple spaces not likely to achieve those guidelines and lacking proper ventilation techniques. Typically, only one small operable window is found in most patient spaces, too small to provide adequate ventilation. Rarely do opportunities for cross-ventilation exist given the double-loaded corridor organization and solid-leaf interior doors.

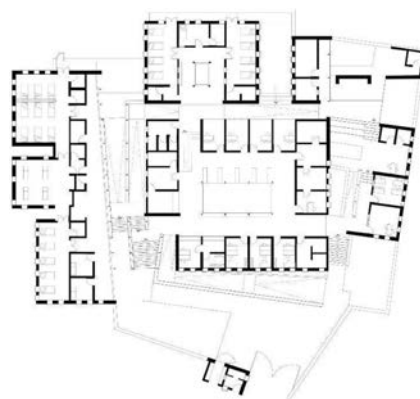
### **3.7 Resilience: energy and water infrastructure**

Energy availability in rural Malawi is unreliable, with “frequent and sustained black outs; functional backup energy sources are rarely available” (Reuland, et al. 2020). Lack of energy affects a health centre’s ability to provide safe, reliable care: reducing lighting, inhibiting pumped drinking water, hindering vaccine refrigeration, and inhibiting sterilization. While PVs can be active in supporting a facility’s needs, most facilities are connected to the grid (Suhrie et al. 2018). The central district MOH health centre had a functional PV array, however, it did not provide sufficient amperage to operate the autoclave.

Water infrastructure in a health centre is typically relates to water, sanitation and hygiene (WASH). Prophylactic WASH implementation, specifically hygiene, have led to statistically significant reductions in nosocomial transmission. Improving the education of hygiene, advancing water access and quality, and a focus on the management/treatment of waste, results in dramatically better health outcomes (Watson, et al. 2019). Many health centres have fairly reliable borehole water systems. However, the strategic location of sources relative to users and programs is lacking, as are back-up or off-grid systems. Additionally, MOH template roof forms do not lend themselves to rainwater collection, with hipped gables directing water in four directions and shedding rain into the courtyard causing flooding during the heavy rainy seasons.



**Figure 2:** MOH Health Centre Plan



### 3.8 Case study analysis

The Kintobo Health Centre (Fig. 3) designed by ASA architects and TAM association is organized in program clusters with major and minor covered exterior spaces suited for circulation, waiting, and separation of patient populations. Figure 3 shows the division of program units and ample outdoor covered circulation. Natural ventilation is achieved through the distribution of courtyards and single loaded program blocks. Nosocomial infection hotspots are reduced due to elimination of closed corridors. The more diversified plan lends itself to views to the surrounding landscape which also allows many circulation options for staff, creating an engaging environment.

**Figure 3:** Kintobo HC Plan



The Rugerero Health Centre designed by ASA architects relies on similar principles of circulation and open space. Figure 4 shows the plan has a double loaded corridor, however it is covered exterior space, providing daylighting and natural ventilation. The program is divided into long- and short-term stay, with maternity and inpatient wards in the rear of the project, isolating populations. This site uses resilient strategies such as large rainwater cisterns, rainwater fed toilets and integrated passive ventilation.

**Figure 4:** Rugerero HC Plan

## 4.0 CONCLUSIONS

This research resulted in conclusions related to user groups and programmatic organization, infection control, and energy and water infrastructure that were then evaluated with MOH stakeholders.

### 4.1 Recommendations

A focus on a responsive program structure can lead to an evidence-based, responsive, and resilient model. From relevant medical literature, interviews, case study analysis, and MOH standard design analysis; design recommendations were developed which aim to impact the objectives. These recommendations are organized relative to user groups (patients and staff), infection control measures, and energy and water infrastructure.



#### 4.2 Users: patient considerations to improve quality of care

Strategic spatial ordering can improve patient satisfaction and QOC, the following methods may improve these metrics:

- Multiple shaded waiting areas adjacent to gardens for various patient populations can:
  - provide privacy for culturally sensitive treatments (HIV therapy, domestic violence, etc.)
  - reduce perceived patient waiting times
  - form a calming connection to nature
- Separate pediatric outpatient programs, with activity zones for young waiting patients
- Visual connections between waiting and program spaces to reduce anxiety

#### 4.3 Users: staff considerations for satisfaction and human resource efficiency

The first key to staff satisfaction is a consistent feedback loop with administrators, including surveys, and interviews. These types of engagements should include issues related to the built environment: location of storage, daily workflows, adequate lighting, time spent travelling between programs, etc. Accordingly, our recommendations include:

- Efficient Program adjacencies
- Organized triage management separate from standard waiting areas
- Strategic circulation paths to separate staff and patients, giving staff a sense of privacy by:
  - Clearly defined patient/staff entries, and well-articulated zones for staff only
  - Frequently used spaces should be in close proximity
- Pleasing housing with reliable energy and water infrastructure
- Well-lit and thermally comfortable spaces to work more efficiently
- Private staff programs, including private exterior spaces for meals and breaks

#### 4.4 Nosocomial infection control and natural ventilation

Nosocomial infection strategies for passively ventilated facilities are arguably the most critical component of health infrastructure design. Windows alone do not achieve ACH goals, nor do single exterior waiting areas. Design considerations should include:

- Permanent exterior covered screening areas with separate circulation sequences post-screening. These spaces can be used for flex-informal space in non-pandemic times, or overflow waiting
- Positive/negative pressure zones in interior spaces to safely exchange contaminated with clean air
- Building organization in response to prevailing winds that can effectively ventilate the structure
- Elimination of closed corridors and dead-end interior circulation routes
- Maximize exterior one-way circulation routes to reduce cross-contamination and congestion
- Where interior, non-ventilated space is necessary, evacuator fans and other ceiling ventilation should be included
- Treatment rooms should have windows on opposite walls to increase cross ventilation
- Hand-washing stations should be permanent fixtures at waiting areas, point of care and services areas. These should be clearly visible to maintenance staff and easily maintained.

#### 4.5 Resilient strategies for thermal comfort, energy, and water infrastructure

Energy and water independence in this context may provide positive health outcomes for its patients and staff, as well as improved perspectives of government health infrastructure by local communities. Design which implements environmental research on off-the-grid energy and water systems can aid in the design of infrastructure solutions such as photovoltaics, rainwater collection units and the implementation of natural healing landscapes. Solar energy is widely accepted in this region already but there must be considerations in place for continued maintenance. Rainwater capture is less frequent, and a significant investment. The rainy season in Malawi lasts six months and is followed by extended periods of drought in the dry season, making long-term storage the necessary solution. However, as resources become scarce and technology more affordable these systems should begin to be considered:

- Building forms should facilitate rainwater capture systems; single pitch roofs optimize capture
- Roofs oriented to maximize photovoltaic efficiency should be implemented
- Increased surface area dedicated to glazing or screened ventilation to improve thermal comfort, increase daylighting, and reduce energy demands
- Infrastructure systems should be highly integrated into the facility, to be perceived as essential
- Sustainable energy systems should be scaled to serve all health centre demands, including lighting, vaccine refrigeration, sterilization, water supply and internet systems.

### 5.0 DISCUSSION

While architecture alone cannot solve all challenges facing Malawi's health infrastructure, it can positively impact patients and staff; however, it must be proven. In contexts with strained human and financial resources, transforming a budget-centric health centre model requires evidence-based methods approved by the medical profession, convincing to donors and stakeholders. While many of the recommendations here are known to architects at the MOH (whose insights informed this work); without reference to medical literature designs typically remain reduced to solely budgetary considerations. This work seeks to bridge the gap between the architectural process and the medical profession, incorporating peer-reviewed medical literature into the design of health facilities develops a more inclusive and effective design process.

Evidence-based design, however, must be context specific. To date most EBD studies are found in high-income countries with infrastructure marked by single patient rooms, mechanical ventilation, and significantly different staff to patient ratios. Health infrastructure practice in LMICs needs the support to methodically design, build, and test in post-occupancy such facilities, then publish results to build upon relevant EBD knowledge. As the role of the architect in LMIC health infrastructure is better understood, it is essential for architects to validate their designs with medical literature, employ evidence-based methodologies then test in post-occupancy the design goals.

Health centres and schools are the main conduits between rural Malawian communities and their government, an important qualitative consideration in the design process. As proven in similar contexts, community engagement in the design and construction process can improve community perceptions while infusing currency into the local economy. For example, the implementation of solar energy has positive impacts on the community's perception of health care, service availability and facility readiness (Javadi et al., 2020). Long-term planning should consider these hard-to-quantify issues. Additionally, broadening the definition of health centers to include public access to water and energy resources, after-school programs, and other community focused programs in the interest of public health may prove similarly impactful.

Relatedly, public health infrastructure should respond to local building vernaculars to gain social acceptance of an often new public program and typology. In rural Malawi, buildings are built by local hands, using mostly locally produced materials and traditional masonry assemblies and forms. Landscapes are formed by the arrangement of numerous small masonry structures. A small village of structures is typically the conceptual 'ground' in which the figural landscape is most critical for: food production, livestock, brickmaking, cleaning, cooking and leisure. For health infrastructure, capitalizing on this landscape vernacular can be a cost-effective strategy when considering waiting and screening areas, public health education, waste management and building infrastructure programs.

Finally, cost, materiality, and delivery methods were deliberately omitted, although undoubtedly play a critical role in the decision-making process at the MOH. This research seeks to define utterly critical, and hopefully cost neutral issues for the MOH to consider. While enduring maintenance budgets continue to be limited, architects must broaden their definition of resilience to include low-maintenance building endurance.

## REFERENCES

- Anderson, D. M., Cronk, R., Best, L., Radin, M., Schram, H., Tracy, J. W., & Bartram, J. (2020). *Budgeting for Environmental Health Services in Healthcare Facilities: A Ten-Step Model for Planning and Costing*. International Journal of Environmental Research and Public Health.
- Chaudhury, H., Mahmood, A., Valente, M. (2009). *The Effect of Environmental Design on Reducing Nursing Errors and Increasing Efficiency in Acute Care Settings: A Review and Analysis of the Literature*. Environment and Behavior, 755-786.
- Chimwaza, W., Chipeta, E., Ngwira, A., Kamwendo, F., Taulo, F., Bradley, S., & McAuliffe, E. (2014). *What makes staff consider leaving the health service in Malawi?* Human Resources for Health, 12:17.
- Cronk, R., & Bartram, J. (2018). *Environmental conditions in health care facilities in low- and middle-income countries: Coverage and inequalities*. International Journal of Hygiene and Environmental Health, 409-422.
- Flick, R. J., Munthali, A., Simon, K., Hosseinipour, M., Kim, M. H., Mlauzi, L., . . . Ahmed, S. (2017). *Assessing infection control practices to protect health care workers and patients in Malawi from nosocomial transmission of Mycobacterium tuberculosis*. PLoS One, 12(12).
- Government of the Republic of Malawi. (2017). *Health Sector Strategic Plan II (2017-2022)*. Government of the Republic of Malawi.
- Hendrich, A., Chow, M. P., Bafna, S., Choudhary, R., Heo, Y., Skierczynski, B. A. (2009) *Unit-Related Factors That Affect Nursing Time with Patients: Spatial Analysis of the Time and Motion Study*. Health Environments & Design Journal, 5-20.
- Jafry, M. A., Jenny, A. M., Lubinga, S. J., Larsen-Cooper, E., Crawford, J., Matemba, C., & Babigumira, J. B. (2016). Examination of patient flow in a rural health center in Malawi. *BMC Research Notes*, 9(1). doi:10.1186/s13104-016-2144-x



- Javadi, D., Ssempebwa, J., Isunju, J. B., Yevoo, L., Amu, A., Nabiwemba, E., . . . Severi, L. (2020). *Implementation research on sustainable electrification of rural primary care facilities in Ghana and Uganda*. *Health Policy and Planning*, 35(Supplement\_2), li124-li136. doi:10.1093/heapol/czaa077
- Merriel, A., Hussein, J., Malata, A., Coomarasamy, A., & Larkin, M. (2018). *Learning from the experience of maternity healthcare workers in Malawi: a qualitative study leading to ten low-cost recommendations to improve working lives and quality of care*. *BMC Pregnancy and Childbirth*, 18:336.
- Reuland, F., Behnke, N., Cronk, R., McCord, R., Fisher, M., Abebe, L., . . . Bartram, J. (2020). *Energy access in Malawian health care facilities: consequences for health service delivery and environmental health conditions*. *Health Policy and Planning*, 142-152.
- Rothe, C., Schlaich, C., & Thompson, S. (2013). *Healthcare-associated infections in sub-Saharan Africa*. *Journal of Hospital Infection*, 257-267.
- Schmiedeknecht, K., Perera, M., Schell, E., Jere, J., Geoffroy, E., & Rankin, S. (2015). *Predictors of Workforce Retention Among Malawian Nurse Graduates of a Scholarship Program: A Mixed-Methods Study*. *Global Health: Science and Practice*, 85-96.
- Suhlrie, L., Bartram, J., Burns, J., Joca, L., Tomaro, J., & Rehfuess, E. (2018). *The role of energy in health facilities: A conceptual framework and complementary data assessment in Malawi*. *PLoS ONE*, 13(7).
- Ulrich R.S. (1991) *Effects of interior design on wellness: theory and recent scientific research*. *J Health Care Inter Des*. 3:97-109.
- Ulrich, R. S., Zimring, C., Zhu, X., DuBose, J., Seo, H.-B., Choi, Y.-S., . . . Joseph, A. (2008). A Review of the Research Literature on Evidence-Based Healthcare Design. *Health Environments Research & Design Journal*, 61-125.
- United Nations Statistics Division. (2019). *World Population Prospects: The 2019 Revision*. Retrieved from UNdata: <http://data.un.org/Data.aspx?d=PopDiv&f=variableID%3A66>
- United Nations, Department of Economic and Social Affairs, Population Division. 2018. *World Urbanization Prospects 2018: The 2018 Revision*. Retrieved from <https://population.un.org/wup/Country-Profiles/>
- Watson, J., D'mello-Guyett, L., Flynn, E., Falconer, J., Esteves-Mills, J., Prual, A., . . . Cumming, O. (2019). Interventions to improve water supply and quality, sanitation and handwashing facilities in healthcare facilities, and their effect on healthcare-associated infections in low-income and middle-income countries: A systematic review and supplementary scoping review. *BMJ Global Health*, 4(4). doi:10.1136/bmjgh-2019-001632
- World Health Organization. (2020). *Maintaining Essential Health Services: operational guidance for the COVID-19 context*.
- World Health Organization. (2009). *Natural Ventilation for Infection Control in Health-Care Settings*.

# Design Evaluation and Public Health: Comparing Frameworks for Increased Health

Traci Rider<sup>1</sup>, Pegah Mathur<sup>1</sup>, Margaret van Bakergem<sup>1</sup>

<sup>1</sup>North Carolina State University, Raleigh, NC

**ABSTRACT:** There is increasing interest and urgency around the topic of population health. Despite the built environment's crucial impact on human health, the built environment is effectively an overlooked strategy in healthcare system structures and policy (Lofgren, Karpf, Perman, & Higdon, 2006). While research in public health often illustrates causal and correlational impacts of interventions on health outcomes, the connection between design and health is often more narrative. Though new frameworks such as the WELL Building Standard and Fitwel attempt to bring structure and validity to this juncture, understanding health considerations in the context of design evaluation has historically been fragmented: operations and health are different lenses for building assessment. Post-occupancy evaluations (POE) have become the evaluation standard for the built environment since its inception in the 1980s, but has never significantly considered health and are cross-sectional by nature. As such, this paper outlines the development of a new framework building on two established evaluation processes: Post-Occupancy Evaluations and Health Impact Assessments (HIA). Post-Occupancy Evaluations seek to measure how well buildings operate after design and construction; Health Impact Assessments are popular in the field of public health, addressing health behaviors and outcomes both before and after potential or actual interventions. By understanding similarities of these two established frameworks, it may be possible to better work toward true impacts of both the operations and the design of built environments. This paper conceptualizes a framework to explore a more health-focused baseline for building evaluation. The intersection between POE (design) and HIA (health) structures an alignment between two perspectives on evaluation that have not overlapped before. The majority of any cross-disciplinary work in this realm has focused on interventions. This paper overlays these two systems, establishing both the challenges and opportunities for a more holistic type of assessment and analysis for the built environment.

**KEYWORDS:** design evaluation; health impact assessment; post-occupancy evaluation; framework development; public health

## INTRODUCTION

Research in the medical and public health fields heavily relies on both causal and correlational studies to address health outcomes. Despite the established connection between design and health, in both housing and planning, the relationship between design and health is generally perceived to be more descriptive, and therefore "softer". New frameworks are being developed at different scales, addressing different building types, such as the WELL Building Standard and Fitwel, which strive to support the rigor and validity in these relationships. These systems are focused on understanding health considerations through design evaluation. However, the realm of "design evaluation" has historically been fragmented; operations, design, and health can all be significantly different lenses for building assessments.

The fragmentation and varied lenses in building assessments makes it difficult to align the need to address population health with the standard methods to assess building performance. Largely this relationship has focused on specific elements, such as planning or landscape design and physical activity; understanding the relationships between indoor air quality, for example, and occupant health are new in built environment literature in relation to physical activity research. Though the Post Occupancy Evaluation (POE) methodology, a systematic design evaluation method, has gained momentum and legitimacy since its inception in the 1980s, the process does not significantly address user health so much as the operational aspects of facilities. Similarly, while the Health Impact Assessment (HIA) framework is recognized as the standard for health intervention implementation and evaluation, it does not readily speak to built environment design strategies and focuses on policy and program interventions. No work is currently found that explores merging these two established frameworks. By recognizing this gap between evaluations in health outcomes and design, though they may be addressing the same project, this paper suggests potential synergies between the two frameworks.

This paper outlines the formative stages towards the development of a new converging framework by building on two established evaluation processes: the Post-Occupancy Evaluation (POE) and the Health Impact Assessment (HIA). POEs seek to understand how well buildings operate after occupancy; HIAs, from the field of public health, evaluate

potential health behaviors and outcomes, often at the community scale, after potential or actual interventions. Neither evaluation is mandatory and, when completed, are often done by a third party at the behest of either the owner or interested stakeholders. By merging these two established and accepted frameworks, it is possible to better evaluate the built environment as an intervention from a public health perspective, focusing on healthy behaviors and ultimately health outcomes. For example, the areas of convergence can be highlighted by recognizing buildings can ultimately be used as public health interventions. Specifically, this paper establishes the important links between building assessments that focus on building performance as well as how buildings act as an intervention to promote health.

## 1.0 LITERATURE REVIEW

### 1.1. Building Evaluations

The building industry is extremely familiar with building rating systems to structure the evaluation of building design and operations in terms of environmental impact, most notably with the U.S. Green Building Council's (USGBC) Leadership in Energy and Environmental Design (LEED) rating system. These standards have historically focused on the design process and implemented strategies for conservation of environmental concerns rather than on the occupant satisfaction level in the building. The WELL Building Standard starts to shift this emphasis, but still emphasizes the building's impact on occupant health, for example in terms of water and air quality, than on occupant experience and satisfaction. The Post-Occupancy Evaluation (POE), on the other hand, was developed as a process to assess how a building was meeting occupant needs and supporting well-being (Li, Froese & Brager, 2018). The POE, as defined by Preiser et al. (2002), is an evaluation of how a building performs after it has been completed and is occupied for a certain period of time. Many stakeholders and users are engaged in the evaluation of the building, often including owners, investors, maintenance operators, staff, and occupants. The value of the occupants' perspective in the POE is elevated and synthesized with the context of the building's operational performance (Preiser, 2002).

Previous articles have traced the path and development of the post-occupancy evaluation (Durosaiye, Hadjri, & Liyanage, 2019; Li et al., 2018), which has been outlined as activities interested in learning building performance after occupancy, with a focus on how well the building meets the expectations of the building regarding the built environment (Vischer, 2002). Preiser (1995) originally focuses on how the building performance addressed in POEs align with performance goals, much like the current commissioning processes found in green building rating systems such as LEED (USGBC, 2018). Later in 1997, Preiser and Schramm (Preiser, 2005) put forth an integrated framework to more fully address building performance evaluation (BPE). Years later, Clements-Croome (2014) supports this distinction between building systems performance and user satisfaction by framing the POE as an evaluation of the designed environment from the perspective of the users. This approach places the emphasis on the occupants within the building, not on the performance of the facility in terms of energy use or lighting quality. As the field evolves, the BPE and POE terminology is often used interchangeably (Williams, Humphries & Tait, 2016); the POE is evolving into a pre-design tool in which groups assess an existing space to inform the next iteration (Oseland, 2018). However, the POE is still framed as one piece to a larger BPE process as shown in Figure 1 (Li et al., 2018). Ultimately, this paper agrees with the notion that a POE should focus on the building's impact on the users, including both from a facilities perspective as well as addressing evidence-based satisfaction and appropriateness for the occupants through a systematic evaluation process (Turpin-Brooks & Viccars, 2006).

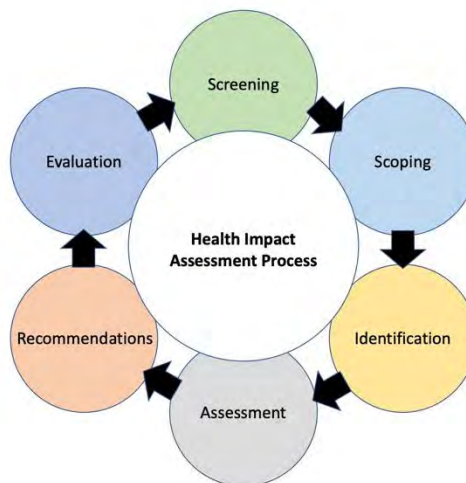
While POEs are highly individualized and case-dependent, based on the intentions of the client and building type, Peixian et al. (Li et al., 2018) synthesize sixteen existing POE protocols across a series of different building types to establish a summary of current state of POE methodology and processes. Findings indicate that most POE processes focus on quantifiable aspects of the building, such as thermal comfort, acoustics, lighting, and energy and water use (Li et al., 2018). These considerations are largely measured through technologies, but also include the use of occupant surveys that gather more subjective data; the survey data is then usually run through statistical or other quantitative analysis (Candido, et al., 2016; Hua, Göçer, & Göçer, 2014). Li et al. (2018, 198) note the increasing understanding of how users impact the building operations, and that the users occupying the spaces largely determine whether a building succeeds or fails. As it stands, most emphasis in the POE literature focuses on physical building performance; the subjective occupant surveys remain supplemental (Li et al., 2018; Schoenefeldt, 2019)

As stated, the six-part building performance evaluation (BPE) model proposed by Preiser and Schramm in 1997 (Preiser, 2005) was planned to more fully address the comprehensive lifecycle of the building. Because of the longevity reflected in the Health Impact Assessment process, this paper will reflect on the BPE process model, but emphasize the occupancy phase as reflected in POE studies. As shown in Figure 1, six phases are largely identified in the BPE process: (1) Market analysis of the needs, (2) Effectiveness review, (3) Programming/ Program review, (4) Project/ Design review, (5) Post construction evaluation, and (6) Post occupancy evaluation. POE is only one evaluative element of this framework. During this phase, the functioning of the facility is evaluated to better understand what works operationally in the design and what does not (Preiser, 2002). Provided the impacts building operations have on occupant health and well-being, there is a potential opportunity to integrate health topics to this particular phase. For Market analysis (planning), the owners and funders review whether the project is appropriate for medium- and long-term needs, mission, and goals. During Effectiveness Review, the strategic planning outcomes from the market analysis

are compared with larger scale considerations including visibility, flexibility, and capital and operation costs. During Programming/Program Review, the community establishes and reviews the programming document that will serve to guide the design of the project, which includes feedback from all occupant groups. In Project/Design Review, the design process and outcomes are cyclically evaluated to ensure that the programming is accounted for, including user needs, and assess the effects while still in design. During Post Construction Evaluation, the construction of the building is assessed through standard processes such as “punch lists”. Finally, during Post occupancy evaluation, the functioning of the facility is evaluated to better understand what works operationally in the design and what does not (Preiser, 2002).



**Figure 1:** Building Performance Evaluation Model. Adapted by authors from Preiser (2005) and Li, Froese & Brager (2018).



**Figure 2:** Six steps of the Health Impact Assessment process. Adapted by authors from Mecklenburg County, North Carolina Health Department and Florida Department of Health (2018).

Literature establishes the current, generalized POE process as focusing on measurement and technology. From the owners' perspective, this quantitative approach is the easiest way to begin to relate investments to returns in terms of elements like lowered energy consumption, worker productivity, and absentee days (Hay, Samuel, Watson, & Bradbury, 2018). However, there is often a lack of important personal considerations, exploring qualities such as feelings of safety, security, and affordances in POE literature. Similarly, additional health impact factors related to occupant mental and physical health are still being understood in the built environment in terms of measurement and assessment methods (Hedge, Miller & Dorsey, 2014; Ferguson & Evans, 2019; Hoisington et al., 2019). Although health indicators have increasingly become important in POE assessments over the past decade (Colenberg, Jylhä, & Arkesteyn, 2020), health is still missing from a majority of POEs.

## 1.2. Health Impact Assessments

A health impact assessment (HIA) is viewed by the World Health Organization (WHO) as procedures by which an intervention, usually in the form of a project or policy, may be assessed regarding its “potential effects on the health of a population, and the distribution of these effects...within the population” (WHO, 1999). HIAs have been included in a range of disciplines (e.g., transportation, energy, housing, urban planning) to evaluate potential environmental and social impacts of interventions in both public and private sectors (Krieger et al., 2003). Yet, the HIA process is rarely required, or even implemented, for large development projects, particularly those privately funded (Winkler et al., 2013). Particularly in developed countries under a capitalist model, the effort required to effectively execute an HIA before design and implementation of a project, program, or development can be seen as unnecessary and burdensome for a developer to meet their goals for the project.

As noted by the CDC, the HIA is a valuable tool to better understand how a suggested decision may affect a population's health. Results of HIA assessments can help determine how certain groups, such as vulnerable populations, would be impacted by the respective intervention, and even how the health impacts would be distributed across a population (CDC, 2016). There are six steps regularly identified with the HIA process: screening, scoping, assessment, recommendations, reporting, and monitoring and evaluation (CDC, 2016). For Screening, the stakeholders establish whether an HIA is appropriate for the scope, or required for development. During Scoping, the boundaries and parameters of the HIA are established, aligned with goals and specific questions. During Identification, the community population profile is established through both theoretical modeling and data collection to understand the unique elements and characteristics of the community under study, specifically to identify potential impacts of the proposed or

actual intervention. In Assessment, data is critically synthesized and assessed to understand how different strategies of the intervention may impact different health outcomes. This synthesis and framing of outcomes will contribute to a prioritization of strategies and health impacts. During Decision Making and Recommendations, opportunities are weighted to establish a final set of recommendations to propose as action items based on the HIA findings. Finally, during Evaluation and Follow-up, the HIA process is evaluated, strategies are monitored, and outcomes are documented (Hirono, et al., 2016).

While the HIA process can be used to understand the impacts of programs or policy interventions, the initiative was originally housed under the CDC's Healthy Community Design Initiative. While no longer active, this version of the HIA was originally developed to specifically work toward "improv(ing) public health through community design." (CDC, 2016) As such, the steps reviewed in the HIA process were outlined to overlay with the design, construction, and implementation activities.

## 2.0. METHODOLOGY

Groat and Wang's (2002) logical argumentation methodology is used to synthesize the two outlined frameworks and suggest a merged structure to approach both the built environment and public health outcomes. As noted, the intent is to take "conceptual systems that, once framed, interconnect previously unknown or unappreciated factors in relevant ways." (Groat and Wang, 2002)

Logical argumentation research adheres to a series of common traits: broad systemic applicability, paradigmatic innovation, a priori argumentation, and testability. In process, this paper explores the POE and HIA frameworks in their broad systemic applicability; both systems can be universally applied to built interventions in communities that can impact change on both users and community health. By taking these two systems that have addressed previously disparate considerations, and interconnecting the two approaches in a unified framework, the resulting discourse can extend into a different paradigm. The notion that building design impacts both user satisfaction and health is an a priori principle that is used in developing the argument; therefore, necessary consequences of a built form can be identified and assessed. Lastly, the resulting framework, or theory, will be able to be tested, impacting normative standards in design for a shift in procedures and enabling the theory to be action-oriented. The outlined framework will follow this described methodology.

## 3.0. DISCUSSION

As noted earlier, the BPE can be broken down into six phases: (1) Market analysis of the needs, (2) Effectiveness review, (3) Program review, (4) Project review, (5) Post construction evaluation, and (6) Post occupancy evaluation. Similarly, the HIA process is also broken down into six phases: (1) Screening, (2) Scoping, (3) Assessment, (4) Recommendations, (5) Reporting, and (6) Monitoring and evaluation. Though these phases do not align smoothly between the two, there are notable similarities. As shown in Figure 3, a number of the six phases align naturally, highlighting themes and scope across the two frameworks.

### 3.1. Phase 1: Appropriateness

The similarity of the first phases focuses on the notion of appropriateness. In an HIA, stakeholders review whether an HIA is appropriate for the project; the BPE assesses whether the project is appropriate for medium- and long-term needs, mission, and goals of the stakeholder. Both of these approaches focus on the particularities of the community and stakeholders involved in the project once it is completed.

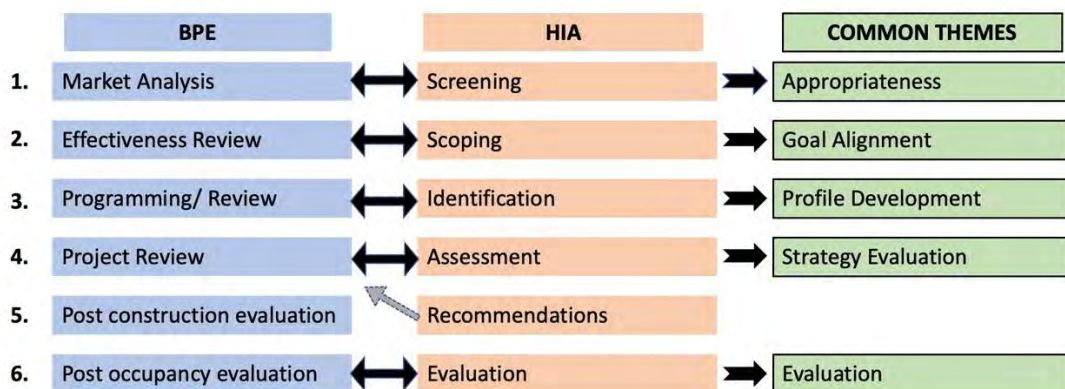


Figure 3: Comparison of the BPE and HIA frameworks (by authors).

### 3.2. Phase 2: Goal Alignment

During BPE's Phase 2, *Effectiveness Review*, the overarching outcomes from the market analysis are compared with larger scale goals such as visibility and flexibility of the project, as well as capital and operation costs. In HIA's *Scoping* phase, boundaries and contextual parameters are established, ensuring that the study will align with specific goals and questions pertinent to the community under question. The goal of both of these phases is to address the proposed project's alignment with stakeholder goals, which are larger than the immediate scope of the building or project. Issues of health are often best addressed at these larger scales.

### 3.3. Phase 3: Profile Development

During HIA's third phase, Identification, a community population profile is established to understand the unique elements and characteristics of the community being addressed. During Programming/Review in the BPE process, stakeholders establish and review the programming document - or project profile - that will guide the project, incorporating feedback from all occupant groups to ensure the project profile is robust. These two approaches both share the idea of a project profile, establishing actual documents as artifacts to ensure that the needs and wants of the community members/ building users are appropriately and thoroughly reflected in the project or program.

### 3.4. Phase 4: Strategy Evaluation

In HIA's Assessment phase, multiple types of data are synthesized to understand how different intervention strategies could affect anticipated health outcomes, which will help the team prioritize possible strategies. In BPE's Project/Design Review, processes and outcomes are continually assessed to assure that the programming criteria and stakeholder views are accounted for, helping to prioritize and recommend different strategies during design while things can be changed more readily. These stages both evaluate potential strategies or programs through data collection and modeling to help prioritize evidence-based options for implementation.

### 3.5. Phase 5: Unaligned

The fifth phase is the one phase without notable similarities between the frameworks. HIA's Decision Making and Recommendations outlines a final set of action items to be recommended. During BPE's Post Construction Evaluation, the construction of the building is technically evaluated and ultimately approved to establish that the project is fit for occupancy. However, while these two phases do not align, the HIA's Recommendations phase could be incorporated into BPE's Phase 4 above, Strategy Evaluation, which ultimately recommends different building strategies to work toward the end goals.

### 3.6. Phase 6: Population-Based Data Collection

The last phases of both systems emphasize data collection. During HIA's Evaluation and Follow-up phase, the overall HIA process is evaluated and monitored, with community-based data gathered to understand the efficacy of the intervention. In BPE's Post occupancy evaluation, user-centered data is collected to understand how the design is working, for both operations and the users. Looking at the BPE through a health lens, the building itself would be the intervention. This final phase emphasizes the importance of population-based data collection.

## CONCLUSION

This paper establishes similarities between POE (design) and HIA (health) frameworks to explore the overlap of two perspectives on building evaluation that have been used in synergy before. By breaking down and overlaying these two systems, similarities and challenges can be more easily identified. This research sought to create a new foundation for future discussion around health and the built environment, exploring a change of focus and realignment for both established frameworks. Given the similar processes identified through this exercise, a small shift in perspective could lay the groundwork for a more holistic type of assessment and analysis for the built environment, working significantly toward healthier community outcomes. Post occupancy evaluations, given the emphasis on user satisfaction and perspective, could easily expand their scope to include programmatic user experiences, which would relate to the design of the building in what types of health initiative and programs the design can support. If buildings are seen as public health interventions, using these frameworks together provides the opportunity to make a much bigger impact on population health. As such, health evaluation can become an important and integrated part of standard post-occupancy evaluation processes.

## REFERENCES

- Candido, C., Kim, J., Dear, R. d., & Thomas, L. (2016). BOSSA: a multidimensional post-occupancy evaluation tool. *Building Research & Information*, 44(2), 214-228.
- Colenberg, S., Jylhä, T., & Arkesteijn, M. (2020). The relationship between interior office space and employee health and well-being – a literature review. *Building Research & Information*, 1-15. doi:10.1080/09613218.2019.1710098



- CDC. (2019). Social Determinants of Health. Accessed February 15, 2020. <https://www.cdc.gov/healthyplaces/hia.htm>
- Clements-Croome, D. (2014). Post-occupancy evaluation. In D. Clements-Croome (Ed.), *Intelligent buildings: An introduction*. UK: Routledge.
- Durosaiye, I. O., Hadjri, K., & Liyanage, C. L. (2018). A critique of post-occupancy evaluation in the UK. *Journal of Housing and the Built Environment*, 34(1), 345-352.
- Ferguson, K.T., & Evans, G.W. (2019). *The Built Environment and Mental Health*. Encyclopedia of Environmental Health. pp.465–69. <https://doi.org/10.1016/b978-0-12-409548-9.11009-7>.
- Florida Health.gov. <http://hillsborough.floridahealth.gov/programs-and-services/community-health-planning-statistics/health-equity/health-impact-assessment/index.html>
- Groat, L. & D. Wang. (2002) *Architectural Research Methods*. John Wiley & Sons: New York, NY.
- Hay, R., Samuel, F., Watson, K. J., & Bradbury, S. (2018). Post-occupancy evaluation in architecture: experiences and perspectives from UK practice. *Building Research & Information*, 46(6), 698-710. doi:10.1080/09613218.2017.1314692
- Hedge, A., L. Miller, and J.a. Dorsey. (2014). "Occupant Comfort and Health in Green and Conventional University Buildings." *Work*. (49)3: 363–72. <https://doi.org/10.3233/wor-141870>.
- Hirono, K., Haigh, F., Gleeson, D., Harris, P., Thow, A.M., & S. Friel. (2016). Is health impact assessment useful in the context of trade negotiations? A case study of the Trans Pacific Partnership Agreement. *BMJ Open*. 6. e010339. 10.1136/bmjopen-2015-010339.
- Hoisington, A. J., Stearns-Yoder, K.A., Schuldt, S.J., Beemer, C.J., Maestre, J. P., Kinney, K. A., Postolache, T. T., Lowry, C. A., & Brenner, L. A. (2019). *Ten Questions Concerning the Built Environment and Mental Health*. Building and Environment. 155: 58–69. <https://doi.org/10.1016/j.buildenv.2019.03.036>.
- Hua, Y., Göçer, Ö., & Göçer, K. (2014). Spatial mapping of occupant satisfaction and indoor environment quality in a LEED platinum campus building. *Building and Environment*, 79, 124-137.
- Krieger, N., Northridge, M., Gruskin, S., Quinn, M., Kriebel, D., Smith, G. D., ... & Miller, C. (2003). Assessing health impact assessment: multidisciplinary and international perspectives. *Journal of Epidemiology & Community Health*, 57(9), 659-662.
- Li, P., Froese, T. M., & Brager, G. (2018). Post-occupancy evaluation: State-of-the-art analysis and state-of-the-practice review. *Building and Environment*, 133, 187-202.
- Lofgren, R., Karpf, M., Perman, J., & Higdon, C. M. (2006). The U.S. Health Care System Is in Crisis: Implications for Academic Medical Centers and Their Missions. *Academic Medicine*, 81(8), 713-720.
- Milan, G.S., Silva, M., & S. Bebber. (2015). Analysis of Attributes and Dimensions of the Built Environment Quality from the Perspective of Employees from Furniture Companies. *Brazilian Business Review*. 12. 66-86. 10.15728/bbr.2015.12.2.4.
- Oseland, N. (2018). *From POE to BPE: The Next Era*. In: Preiser W., Hardy A., Schramm U. (eds) Building Performance Evaluation. Springer, Cham: New York, NY.
- Preiser, W. (1995). *Post-occupancy evaluation: how to make buildings work better*. *Facilities*, (13)11; 19-28.
- Preiser, W. F. E. (2002). *Learning from Our Buildings: a State-of-the-practice Summary of Post-occupancy Evaluation*. Federal Facilities Council. National Academy Press: Washington D.C.
- Preiser, W. F. E. (2005). *Building performance assessment—from POE to BPE, a personal perspective*, *Architect. Sci. Rev.* 48; 201–204.
- Schoenefeldt, H. (2019). The House of Commons: a precedent for post-occupancy evaluation. *Building Research & Information*, 47(6), 635-665.
- Turpin-Brooks, S., & Viccars, G. (2006). The development of robust methods of post occupancy evaluation. *Facilities*(24), 177-196.
- USGBC. (2019). *Leadership in Energy and Environmental Design v4 Rating System Reference Guide*. USGBC: Washington D.C. Accessed February 15, 2020. <https://https://www.usgbc.org/guide/bdc>
- Vischer, J. (2001). Post-occupancy evaluation: A multifaceted tool for building improvement. In L. Stanley (Ed.), *Learning from Our Buildings: A State-of-the-Practice Summary of Post-Occupancy Evaluation*. Washington DC: National Academy Press.
- WHO. (1999). *Health impact assessment: main concepts and suggested approach: Gothenburg consensus paper*. Accessed February 15, 2020. Retrieved from Copenhagen: [http://www.impactante.ch/pdf/HIA\\_Gothenburg\\_consensus\\_paper\\_1999](http://www.impactante.ch/pdf/HIA_Gothenburg_consensus_paper_1999)
- Williams, J. J., Humphries, B., & Tait, A. (2016). "Post Occupancy Evaluation and Building Performance Evaluation Primer." Royal Institute of British Architects: London, UK.
- Winkler, M. S., Krieger, G. R., Divall, M. J., Cissé, G., Wielga, M., Singer, B. H., . . . Utzinger, J. (2013). Untapped potential of health impact assessment *Bulleting of the World Health Organization* (Vol. 91, pp. 298-305). Geneva: World Health Organization.

# Expanding Youth Opportunity Studio: Design Research Engaging Community Participants

Julia W. Robinson<sup>1</sup>, Alysha C. Price<sup>2</sup>

<sup>1</sup>University of Minnesota, Minneapolis, MN

<sup>2</sup>Price Dynamic, Minneapolis, MN

**ABSTRACT:** A successful research-based design studio that includes community engagement is dependent upon pedagogy that serves both student and community participants. This case evolved from 2019 to 2020 based on lessons learned by the research team of students, faculty, community members and contributing critics. The 2019 *Preventing Youth Incarceration* studio addressed the needs of at-risk youth, including those in detention. The research-based studio explored adolescent development, mental illness, addiction, and trauma, addressing the county request for a spectrum of treatment facilities that are not institutional and meet the new concern for trauma-informed care (Olafson et al, 2014). Work with community members began in fall 2019, when the studio focused on North Minneapolis, a neighborhood of origin for many adjudicated young people, and affiliated with UROC, the university research center. A community consultant selected nine community members to work on the project, who received a stipend to cover their time and expenses. They served on reviews alongside design and incarceration professionals. In fall 2020, the studio continued, but due to COVID-19, held meetings online, rather than at the research center. The paper addresses the challenges of developing a design pedagogy that supports student learning while engaging community participants. It focuses on selection of participants, scheduling reviews, maintaining participation throughout the semester, and the challenges of working with community participants in person versus online.

**KEYWORDS:** Community Participation, Studio Pedagogy, Youth, Incarceration, Remote Learning

## 1.0 THE DESIGN STUDIO AS A SITE FOR RESEARCH<sup>1</sup>

Among the many approaches to architectural research, the design studio is valuable for exploratory research (Robinson 2019, Robinson & Christenson forthcoming). Exploratory research seeks to understand and define a particular question that is not fully formulated, in this case, “what can architectural design contribute to the problem of juvenile incarceration?” Exploratory research investigators need to be open to unexpected insights and to explore directions unforeseen at the beginning. These changes of directions in this project are reflected in the studio’s evolving name, first *Reconceiving Juvenile Incarceration* (Fall 2018), then *Preventing Juvenile Incarceration* (Fall 2019), and finally *Expanding Youth Opportunity* (Fall 2020).

In 2016, Hennepin and Ramsey Counties in Minnesota had jointly proposed a new juvenile incarceration facilities at Hennepin County’s existing suburban location. However, the community rejected the design as too large, too institutional, and too far from residents’ families (Smith, 2016). The architecture studio *Reconceiving Juvenile Incarceration* was a cooperative effort led by Julia Robinson of the University of Minnesota School of Architecture, Daniel Treinen of BWBR Architects, a firm experienced in justice facilities and behavioral design, and Angela Cousins, then juvenile facilities director for Hennepin County Department of Corrections and Community Rehabilitation (DOCCR). The studio’s charge was to consider replacing the existing Home School, in the context of developing a spectrum of care for adjudicated youth and for those at risk of incarceration. The first studio was in Fall 2018, with the subsequent studios in the next two fall semesters.

From the beginning, the studio research team of students and instructors investigated the full range of issues to be considered in designing for at-risk youth, to learn about mass incarceration, and to understand the existing juvenile incarceration system and alternatives. Each class read articles and books, watched videos, made site visits, learned from guest speakers, and had their work reviewed by design and incarceration and/or social service professionals.

Also consistently, the students completed design exercises designed to inform them about program and neighborhood, to explore architectural expression of positive, non-punitive attitudes, as well as to support their completion of an architectural design in the 15-week period of the class. Based on the approach of *programming as design* (Robinson & Weeks, 1984), the exercises consisted of 1. Preconceptions, 2. Precedent Analysis, 3. Neighborhood and Urban Analysis, 4. Program and Site, 5. Ritual and Place, 6.) Design-A-Room, and 7) Final Schematic Design. The goal was to use research as a basis developing a program and design of a facility that would serve at-risk and/or adjudicated youth in a spectrum of services.

## 2.0 COMMUNITY-ENGAGED DESIGN

Inclusion of stakeholders in design decision-making in architecture is used in several kinds of design practice especially community and urban design. Although participatory research began in the 2018 studio, the tragic death of George Floyd, and the racial disparities seen the COVID-19 pandemic in 2020 have led to an increased concern with race, social justice and equity, in relation to the architectural profession, and an increased interest in accounting for voices outside the profession. While community-engaged or participatory design practitioners have employed various methodologies (e.g. Sanoff, 1990; Hester, 1990), and academics have developed pedagogies for lay participation in design studios (e.g. Hardin et al, 2006) there is no widely accepted methodology for design studio instruction with participation by lay people.

The approach taken here was based in the neighborhood of study. Northside neighborhood residents identified by the community consultant (see below for the process) met as a focus group, and then served on reviews of student work. Participants received \$50 gift certificates for participating for two hours. In 2019 neighborhood participants reviewed student work alongside professionals in the neighborhood at the research center, and in 2020 they engaged in reviews both with professionals and also as an independent group, meeting online due to COVID-19. Additionally in 2020, we had the opportunity to have a review with transition-age youth.

## 3.0 PROJECT HISTORY

The first year of the research, in the studio called *Reconceiving Juvenile Incarceration*, the goal was to develop architecture that would support non-punitive attitudes such as education, or normalization: “ We will investigate new approaches to program and design of facilities that move away from older attitudes of punishment, and toward the juveniles’ education, rehabilitation, transformation, and de-institutionalization.” (Robinson, 2018)..

During the research, several observations transformed our approach. First, a site-visit comparison between the county Home School, and an architectural award-winning adolescent treatment center showed not only great architectural contrasts (one being built in the 1960s, having concrete block walls and linoleum floors, and the other built of brick with plaster walls and carpeted floors ), but also greatly contrasting populations. The county facility, supported by the taxpayers, housed only youth of color, whereas the treatment center, paid with private health insurance, housed 95% Caucasian youth. Also, a DOCCR map showed that youth in the justice system came primarily from two areas of the city, both classified as “Areas of Concentrated Poverty where 50% or more of residents are people of color” (Metropolitan Council, 2014, 5:12).

Additionally, two class speakers, parents of incarcerated youth from these neighborhoods had similar experiences raising their families. As single mothers with several children holding two minimum-wage jobs, forced by housing cost to live in neighborhoods with crime and gangs, they couldn’t afford child care. Their the children were looked after by family members inexperienced, and unprepared to deal with adolescents. This led us to see the community need not only for a spectrum of treatment for youth as requested by the DOCCR, but also the need for a spectrum of family care that started with a mother’s pregnancy, included child and family members throughout infancy, preschool, elementary, middle and high school, job training or college, and ended with independent living as a young adult.

Finally, our visit to the Home School made us aware of several problems with its location: 1) adjudicated youth had to leave their neighborhood schools to attend a focused, but narrow curriculum program at the site, 2) public transportation, the primary mode used by most parents, was unavailable, so visits were primarily available when a bus was provided, which would not necessarily work with a parent’s work schedule, and 3) when treatment was complete and the youth returned home, they had to leave established relationships with therapists, so consistency of care was disrupted.

These various observations led us to several conclusions. The first is that Caucasian youth who got in trouble were not sent to juvenile detention facilities. Rather than being categorized as *criminal*, they seemed to be considered *troubled*, and sent to treatment. The second conclusion, supported by research,(e.g. Looney & Turner, 2018) is that youths in neighborhoods with high levels of poverty levels and high proportions of populations of color are more likely to be involved with the justice system. The logical extension of these two observations is that the judicial system was subject to, and perpetuating institutionalized racism.

Along with these observations we discovered in our reading of literature that youth in the justice system were very likely to have been traumatized by experiences in their neighborhoods or families, and to experience problems with mental health (Ford et al, 2007; Dierkhising et al, 2013), and that traditional incarceration settings are not rehabilitative, but aggravate trauma (Lambie & Rendell) . Furthermore, recidivism, or repeated criminal activity is higher in youth that are incarcerated than in similar youth who were given treatment in community settings (Underwood et al, 2006), and that experts advocate ending incarceration for youth altogether (McCarthy et al 2016, Shiraldi, 2020).

We concluded that adjudicated youth should be considered to be *troubled*, and given treatment in their communities rather than incarcerated as *criminal*. Therefore, in our 2018 studio, students focused on designs that addressed

prevention of incarceration rather than improving the existing incarceration system, developing programs for after-school activities, job training, and families. While acknowledging its significance, we did not address the problem of violent youth. Our goal is expressed in the following comments.

“We must hold young people accountable for the wrongs they do, but at the same time we must treat them not as the criminals we fear they will become but as the contributors we wish them to be. Re-thinking youth imprisonment is one big step we can take toward that goal.” Assistant Attorney General Karol V. Mason, (Mason 2016)

When designing facilities in 2018, students chose sites in neighborhoods where Home School youth came from, identifying services that were available in the neighborhoods and designing their projects to fill in gaps in services. We realized our approach made possibly incorrect assumptions about the neighborhoods. The instructors decided that for the studio in fall of 2019, we would focus on North Minneapolis, and include community participation in our pedagogy. Student projects included community centers for family education, facilities for after-school activities, and for job training.

#### **4.0 COMMUNITY PARTICIPATION YEAR 1 (STUDIO 2)**

Once again, in Fall 2019, Robinson, Treinen and Cousins taught the final undergraduate Bachelor of Science Studio, *Preventing Youth Incarceration*, with the goal of addressing at-risk youth, including those in detention. The focus on prevention was paired with trauma-informed care (Olafson et al, 2014), and included participation by community members. Understanding the community required adding an urban analysis exercise focusing on North Minneapolis, with the design pedagogy otherwise following the *programming as design* approach described in section 1.0.

**4.1 Community Engagement** Having decided to focus on the Northside, the project affiliated with University of Minnesota Urban Research and Outreach-Engagement Center (UROC). Center leaders recommended Alysha Price as community liaison, who identified 9 participants and supported their participation. At an introductory meeting with the participants, led by the consultant and attended by the lead instructor, community members not only discussed their interest in at-risk youth, but also identified two neighborhoods to focus on, Hawthorne and Folwell. We provided a transcript of the residents' comments to the students. Of the seven reviews of work that were held that year, five included the community participants (at their choice) alongside professionals. These sessions took place at UROC during the second half of the studio class, from 3:30-5:30, which meant that the community reviewers did not attend the entire review. Gift card stipends were given to participants at the end of meetings. Neighborhood participants were also invited to join the students in the site visits, as a part of the whole group learning together (three participated).

**4.2 Research.** Similar to 2018, in 2019, students completed readings, watched videos, participated in talks and panel discussions with experts (designers, youth detention and treatment center personnel), and visited three sites (The Hennepin County Adult Correction Facility and Juvenile Detention Center, and the Hazelden Center for Adolescent Addiction Treatment. Additionally, the class visited neighborhood facilities including the Northside Health Clinic. As a part of the research and design approach, speakers and project reviewers included professionals such as architects and people working within youth facilities for treatment and incarceration, many of whom from the BIPOC community. Community participants were invited to attend the site visits (three joined the class for site visits). At the clinic, we were hosted by Brandon Jones, who gave an inspiring talk about the programs offered, noting that is transition-age youth need attention. Young people, post high school may be at loose ends when they no longer have the structure of a school day. Unlike those with college as a four-year transition to adulthood, for youth in the Northside, adulthood may be signaled by prison or pregnancy. This led to a focus on design for transition-age youth in this and the subsequent studio.

**4.3 Student Projects.** Community participants informed the 2019 student projects about developing programs and choosing sites. Concerned about the lack of options for older youth other than sports, they especially advocated for arts programs. Projects addressed primarily transition-age youth (photography collaborative, restorative justice, transition from incarceration, garden and food service, construction job training), after school activities (teen music center, family bonding center, teen social center), and therapy (music therapy, animal therapy, sports therapy). In response to advice, students chose sites along a primary commercial street, or in the undeveloped area near the river.

**4.4 Organization of Reviews.** With 11 student projects (two projects had teams of two) to be reviewed in four hours for professionals, and two hours for community participants, scheduling was a challenge, solved by having several simultaneous reviews. That required a large number of reviewers and community participants. Over the semester, ten community members and twenty-four professionals participated in reviews (3 from the county, 9 practicing designers, 5 university researchers and 7 university faculty members). Of the professional reviewers, six were people of color, and five resided in the neighborhood.

Three review teams were each led by one instructor, and student work was reviewed by two of the three teams. Professionals participated all afternoon, and community members joined for the second half from 3:30-5:30, after a break. Having reviews held at the university research center, required time for students to set up and take down the

work. The space accommodated posting all the student work at once, although it was crowded. Individual students and teams had 20 minutes to present their work. Having students reviewed by two teams required short review times. The afternoons often felt rushed, and it was difficult to keep within the time framework.

**4.5 The Recruitment Strategy for Community Participants.** In 2019 with a goal of ten community members, we successfully recruited nine. Participants, ranging in age from 25 to 60 years old, five female and four male, were encouraged to share their personal and professional knowledge of the Northside community. In an open dialogue focus group and design reviews.

Community Consultant, Alysha Price targeted African American families who were parents of adolescent and teenage youth and/or worked within an organization that served this population. In addition to geographic connection, she also targeted community members who felt strongly about ending generational cycles of incarceration. Four participants were single mothers due to their child's father being incarcerated. These mothers shared a fear of their children being targeted, stereotyped, or pressured into a similar lifestyle. A community elder was recruited to help provide context and carry forth stories of community pride and empowerment. Having an elder helped to understand historical community changes, not just spatially, but how the spirit of the community had become less communal than it had been in the early 1960's and 70's.

It was imperative that the community members have a personal connection to North Minneapolis and could speak from an authentic place. Because each participant had family experience with incarceration, they were concerned to prevent youth from following in the footsteps of their family members or fathers.

#### 4.6 Lessons learned in 2019

*Student-Community Meetings-* In-person focus group and reviews were engaging, allowing students to connect and witness community members' non-verbal energy and excitement about the community.

*Selection of Participants-* The cross cultural and generational experience that the project provided was outstanding. Students spoke to the value of meeting and learning from the community members.

*Retention-* Retention of community participants was not 100% due to the time of the class. This seemed to interfere with sports schedules of the participants that were coaching, especially males.

*Participant Cohort-* Although the group developed a sense of being a cohort, we thought the having regular meetings, versus diverse participation options would reinforce the cohort. We also thought that combining participants on reviews with professionals might have detracted from developing a sense of cohort.

*Communications-* Communication was often hard to track, with email messages coming to participants both from the lead studio instructor and from the consultant. – The many choices for participation in site visits and reviews caused confusion.

*Mixing Community Members & Professionals-* Combining professional and community participants may have reduced the impact of community voices.

*Meeting Location-* Holding meetings at UROC, located at the heart of the community, was a good choice.

*Length of Presentations/ Team Projects -* Having student work seen by two review teams resulted in reviews 20 minutes in length. Students successfully presented work in 10 minutes, but 10 minutes of comment time was difficult to maintain, with reviews often running over time, and difficulty maintaining the schedule. – Having many students work as individuals created a large number of projects to review. With three instructors it was manageable, but challenging to assure students access to community reviewers. – Projects completed by student teams were generally more developed and responded more robustly to exercises and to research than projects by individuals

*Scheduling-* Holding reviews on Friday afternoon was a problem since on unlike other days, the research center was not open in the evening, and had a closing time of 6:00pm sharp.

### 5.0 STUDIO PARTICIPATION YEAR 2 (STUDIO 3)

In Fall 2020, in response to the COVID-19 pandemic, only Robinson taught the studio, this time called *Expanding Youth Opportunity*. Focusing on transition-aged youth, we aimed at providing housing, job training, education, and other activities that invest in youths' future. Thee focus on prevention was again paired with trauma-informed design included participation by community members, and followed the *programming as design* approach.

**5.1 Community Engagement.** Instruction and participation were remote and online. Our single facility site visit was virtual, to the Home School although we visited the neighborhood in-person, guided by local activist/ architectural firm owner/ Jamil Ford. The design pedagogy was largely similar as described above, including the sketch model exercise using materials kits provided to the students, but using digital models for other three-dimensional representations. While a few initial exercises were individual, beginning with week 6 of the 15-weeks students worked in teams of two. This was especially important because we had one functioning instructor.

Based on 2019, we simplified participation, reducing meetings/ reviews to three. The first meeting again included only community members. With their permission, and to capture the rich comments, we recorded the Zoom meeting. Supplanting a meeting between students and community, students reviewed and discussed the recorded meeting. We also did not include participants in educational experiences, or provide a choice of reviews. Instead, they participated

on three reviews: a formal neighborhood analysis review with professionals, and two informal reviews on program and site with only community participants, designed to reinforce the participants' group, and to focus on their voices. Communications were also simplified. The consultant handled all informational message. After each review, gift cards were distributed by post to participants by the principal investigator/ design instructor.

**5.2 Neighborhood Focus.** In 2020 simplification included focusing on only the Hathorne neighborhood. The east part of the neighborhood is along the river, but divided from the larger neighborhood by a four-lane highway. It has a large commercial street to the south and a heavily trafficked road to the north. To the west and north are other neighborhoods with similar demographics. Although we again affiliated with UROC, working remotely meant that we did not use the facility.

**5.3 Research.** Working remotely meant a greater focus on readings and videos than previously. We documented the in-person visit to the neighborhood in real time using a phone, and video recording, since not all students could attend. Those absent felt this gave them a good sense of the tour and the place. Our virtual visit to the Home School took place using computer and phone, presented by a facility employee and Cousins. We again had talks, this time on Zoom with architects of youth and transition facilities, as well as administrators of housing for transition-age youth, and transition facilities, several of whom who also served on reviews. For reviewers, we followed a similar protocol to 2019, including experts of color: designers, administrators and government officials knowledgeable about youth facilities. This group included neighborhood professionals recommended by our consultant. Similar to 2019, students investigated neighborhood services, identifying existing facilities for youth and gaps in services to fill. Additionally, we included three transition-age youth who reviewed student projects late in the semester to assure they would be attractive and appropriate for young people. Ideally, this would have happened earlier.

**5.4 Student Projects.** Although the majority of community participants struggled with remote participation, and many were unable to join our last two reviews, students received extensive feedback about their work from those that did participate and from several neighborhood practitioners. Students learned about the challenges facing transition-age youth, such as finding housing, homelessness, and the need for therapy, jobs, mentoring and job training. As a result, the projects included job training and entrepreneurship center for music, culinary arts, mechanical arts and performance, entrepreneurship education, commercial youth center), homeless youth (housing and job training, community kitchen and emergency housing), therapy (community-oriented therapy, housing for youth with mental illness and trauma) and a community justice center run by youth. Following to the advice of community reviewers, projects were located on the primary commercial street, in a former school they renovated, and on a site along the river.

**5.5 Organization of Reviews.** To make reviews less rushed, in 2020 we reduced the number of student projects by having students work in teams of two. Most formal reviews included only professionals, and new, informal reviews included only community participants. Formats of reviews, developed in discussion with students, varied more than previously. Typically, there were two simultaneous reviews, with four student teams receiving feedback in each afternoon. When community members participated, they joined in the second half of the afternoon. With time allowed for set-up, a break, and a half-hour summary at the end of the afternoon, this allowed each team to have 45 minutes per review. But when community participants informally reviewed work as a cohort in the last two hours of class, anticipating attendance problems, we organized two groups of four student projects. In forty minutes both teams presented in the first 20 minutes and reviewers commented on both teams for 25 minutes.

Because attendance at reviews is unreliable, it was important to have a large number of reviewers and community participants. Over the semester, ten community members and comparable to previous years, twenty-two professionals participated in reviews (three from the county, nine practicing designers, five university researchers and seven university faculty members). Six of the professional reviewers were people of color, and five were neighborhood members.

**5.6 The Recruitment Strategy for Community Participants.** The 2020 recruitment goal was ten community members, of which we successfully recruited nine, to participate in open dialogue and design reviews. Again, participants were encouraged to share their personal and professional knowledge of the Northside community. Participants ranged in age from 35 to 45 years old and were all female.

Community Consultant Price ran a campaign on social media outlets Facebook & Instagram, targeted toward residents of North Minneapolis who wanted to revive their community through designing safe places for youth enrichment. Those interested were asked to complete a survey of their availability and to share why they wanted to participate. This generated the interest of 20 individuals who were narrowed down based on availability and ability to commit to the 3 months of engagement.

This year recruitment included community members in positions of ownership or leadership within the community, therefore with a different community investment than in 2019. Interested in programming and access, participants sought to address lack of resources to initiate needed community change, and to create opportunities for people of



color to have positions of power. Engaging youth in community decisions was central to change. Of the participants, two are owners of home-day care businesses, one is the executive director of a community organization serving only North Minneapolis, one member works for Minneapolis Public Schools, four members work in youth-serving organizations, and one member disclosed her child is involved in the current community gang violence. She participated to give a voice to mothers who don't know how to save their children. In addition to the community participants, the consultant recruited professionals from the area to enhance the quality of the class instruction experience. These individuals offered a robust understanding of the community needs, and of what is already being done. The community professionals assisted with field trips, gave presentations and participated in reviews.

Finally, participation by three transition-age youth reviewers (two staff and a resident) was enabled by an administrator of housing for transition-age youth, one of the professionals identified by the consultant.

### 5.7 Lessons learned in 2020

*Student-Community Meetings-* Fewer meetings and reviews improved tracking of meetings.- Students learned about the neighborhood and about residents' circumstances. Participants helped choose sites and enhance programs.

*Selection of Participants-* More developed selection methods generated a narrower range of community participants with limited internet access. -Consultant-recruited community professionals who had access to good internet equipment provided local information in addition to community participants. - Ideally design for transition youth should include their participation from the beginning. Transition-age youth are legally of majority, alleviating many problems with their participation. Even late in the semester, inclusion of youth in the project was valuable.

*Retention-* The pandemic created problems for Participation and retention of community participants was affected by the pandemic: lack of in-person participation, poor internet connection, illness, need to look after children, and lack of a quiet place to participate - It is difficult to retain a cohort of community participants when participation is spread over 3 months

*Participant Cohort-* Because of poor internet connectivity, participants did not attend consistently and there was no sense of cohort overall. Nevertheless those who did participate, committed to the project.

*Communication-* Limiting direct email communication with participants to the consultant, allowed for smooth and consistent messaging with no confusion.

*Mixing Community Members & Professionals-* Having reviews with only community participants allowed focus on their ideas. One community participant voluntarily joined the final review with the professionals. Not having community members on the final review inhibited good closure to the project

*Meeting Location-* Not being able to meet in-person was as a barrier to participation. While internet connectivity was a problem for several participants, usually reconnection took place. However, difficulty with connections affected participation.

*Length of Presentations/ Team Projects* – Having fewer projects due to student teams, made reviews more manageable and allowed more in-depth feedback. Quality of projects remained equivalent.

*Scheduling* - The class schedule of 3:30-5:30 inhibited community participation for males. A schedule outside of class time would be better: 4-6, 4:30-6:30 or 5:00-7:00.

## 6.0 LESSONS FOR COMMUNITY PARTICIPATION

**6.1 Recruitment** Although the neighborhood comprised several racial groups, our recruitment process identified exclusively Black residents as participants, likely because our consultant had excellent community ties within that group. Since the youth in county detention are by far predominantly Black, we retained our consultant and the process of selection in the second year. However, in future work with the North Minneapolis, we will develop a more diverse group of community participants. Recruiting male participants was difficult because they were less likely to have time available during class hours. Thus, the second group of community participants did not include any males, although we were fortunate to have male local professionals identified through the consultant who contributed their perspective on neighborhood issues. The number of participants is another issue of concern. Obviously with a larger number of people comes more potential diversity of race, age and experience. Commitment to work over a three-month period was another a challenge to participation,. especially for people in difficult economic situations, whose participation may be especially valuable (parents with young children, and for 2020, those with limited technology and difficulty connecting to the internet, etc.). However ideally feedback on classwork occurs throughout the 15-week semester. This raised the question of whether it would be better to focus on a few participants who could commit to the project rather than a larger number assuming some might drop out. Another consideration was whether a larger stipend than \$50 for two hours would encourage more commitment.

**6.2 Retaining Participants.** In 2019 retention was high. The group of nine was diverse in terms of age and gender, and the students and community participants met in person at the university research center for discussion and reviews. The community members could choose which reviews to join in the middle of the semester, but all but one joined in the final review. We wondered if we could have developed more of a sense of cohort if they met together each time. When we met remotely in 2020, again with nine of participants, the group was less diverse, with all females, and no one over age 45. While participation in the first meeting was relatively good, with eight attending, only four participants met with the students after that. Meeting over the internet had one advantage in that people didn't have to travel to get to the

research center, but there were significant technical and practical problems. Because of pandemic, many were supervising children during the reviews. Most participants used telephones to join the meetings, and to maximize good connection or to find a quiet place, chose to meet in their cars, often with children in the back seat. In the middle of a review, connections were sometimes lost and then reconnected. This frustration likely contributed to the substantial loss of participants at 56%. Provision of appropriate technology to participants might alleviate that problem, although the pandemic created a combination of difficulties that may have been impossible to overcome. Despite all the barriers, those who participated provided excellent information to the class.

**6.3 Reviews, Group Identity & Scheduling.** To maintain interest and also to allow sufficient time to give feedback on student work, we found that a two-hour block of time was optimal, and meeting later in the day was best, so we chose the second half of class time, 3:30-5:30 for meeting with community members. A related issue is whether meetings/ reviews between students and community participants should include only students and community members, or whether it should also include professionals.

In 2019, community members met once by themselves and once at the start of the semester with students. They subsequently participated on two to four reviews with professionals. They were invited to choose one, two, or three interim reviews and to attend the final review, which distributed participation for interim reviews across four possible dates. Almost all community members attended the final review. In 2020, participation in the remote meetings was organized differently. We limited the number of meetings overall and included all community members in each community review. The first review was a formal review with professionals, and the last two were informal reviews for only students and community members. This responded to two intentions, one, to fully hear the community voices prior to the design-decision-making represented by formal presentations, and two, to encourage participation by developing group identity. The meetings without professionals in 2020 enhanced the ability of community members to give feedback. In 2020 the final review was not a part of their stipend participation, but community members were invited to attend without a stipend. Two planned to participate. In the end the pandemic made it possible for only one to join the final review.

The initial in-person meeting with students before reviews enhanced the connection between students and community members in 2019. Having participants sign-up for different reviews spread their feedback throughout the semester, but complicated managing participation. The trade-off wasn't worth it. Having all community members attend the final review in person in 2019 provided a celebratory end to the semester that was very satisfying to all. Because the pandemic influenced participation in 2020 – the Black community in North Minneapolis was especially hard-hit- we will not know whether our new proposed structure would have been more successful in a normal year. It does not seem that the lack of retention of participants was affected by the structure or timing of the reviews, but by technology, COVID-19 and child care needs.

**6.4 Proposed Future Approach.** Observations from the two semesters, indicates the value of a recruitment plan that would identify participants committed to the project that represent the racial and ethnic groups in the community. At the same time, having a smaller group of participants (five to six), would make it easier to maintain connection, communication, and thus retention. Continuity throughout the semester, would benefit from having more meetings (four to five) spread over the period of the class, and continuing with the present \$50 stipend. Meetings and reviews at the end of the afternoon worked well, although evening meetings might be even better. A good plan would include four two-hour meetings: an initial meeting with only students and participants, two informal reviews with exclusively community members and students, and final reviews with professionals. Ideally all of these meetings would be in-person and held in a community setting. Meetings on internet require technology available to all. In sum, for future community participation, I would have fewer participants (five to six), would have more meetings (four to five), and would continue with the present stipend, knowing that with more meetings, the total remuneration would be higher.

## 7.0 CONCLUSIONS

Including community members in the studio requires a budget (for recruiting and managing participants and for paying stipends) and a well-organized plan. In this case, when we also incorporated a large number of voluntary professional reviewers, arranging reviews required a much larger effort than a typical design studio. Nonetheless, the inclusion of community members in the studio was of great value, and well worth the investment. The students learned deeply about the neighborhood history and existing situation. They learned about their White privilege and the challenges faced by Black people in a segregated neighborhood on a daily basis from first-hand observation. Students received excellent feedback on their projects in relation to program development and site selection that greatly enhanced their decision-making skills. The community participants appreciated the concrete proposals made by the students that addressed needs they had identified. The architectural designs allowed them to re-envision their neighborhoods as places where their needs could be addressed, and as a good and beautiful place to live.

## REFERENCES

- Dierkhising, Carly B., Susan J. Ko, Briana Woods-Jaeger, Ernestine C. Briggs, Robert Lee, and Robert S. Pynoos. 2013. "Trauma Histories among Justice-involved Youth: findings from the National Child Traumatic Stress Network," *European Journal for Psychotraumatology*, 4:10, Taylor & Francis website.
- Ford, Julian D., John F. Chapman, Josephine Hawke, and David Albert. 2007. "Trauma Among Youth in the Juvenile Justice System: Critical Issues and New Directions", National Center for Mental Health and Juvenile Justice website, June.
- Hardin, Mary C., Richard Eribes & Charles Poster (Eds). 2006. *From the Studio to the Streets: Service-Learning in Planning and Architecture*. Sterling VA: Stylus
- Hester, Randolph T. Jr. 1990. *Community Design Primer*. Ridge Times Press.
- Lambie, Ian & Isabel Randell. 2013. "The impact of incarceration on juvenile offenders," *Clinical Psychology Review* 33 (2013) 448–459
- Looney, Adam, and Nicholas Turner. 2018. *Work and opportunity before and after incarceration*. Washington, DC: The Brookings Institution.
- Mason, Karol V. 2016. "The Pitfalls of Youth Incarceration." Office of Justice Programs blog, December 8. <https://www.ojp.gov/sites/g/files/xyckuh241/files/archives/blogs-2016/2016-blog-youth-incarceration.htm>
- McCarthy, Patrick, Vincent Schiraldi, and Miriam Shark. 2016. "The Future of Youth Justice: A Community-Based Alternative to the Youth Prison Model." *New Thinking in Community Corrections Bulletin*. Washington.: U.S. Department of Justice, National Institute of Justice, 2016.NCJ 250142.
- Metropolitan Council. 2014. *Choice, Place and Opportunity: An Equity Assessment of the Twin Cities Region* (Report to the U.S. Department of Housing and Urban Development). <https://metrocouncil.org/planning/projects/thrive-2040/choice-place-and-opportunity.aspx>
- Norouziyanpour, Hirbod.2020 "Teaching architecture through community engagement; strategies for service learning in architectural education," *AIA journal*. American Institute of Architects, June, 18(2):68-71
- Olafson, Erna, Jane Halladay Goldman, Carlene Gonzalez, and National Council of Juvenile and Family Court Judges, Reno, Nevada. 2016. "Trauma-Informed Collaborations Among Juvenile Justice and Other
- Paton Joni, Crouch William, Camic Paul. Young Offenders' Experiences of Traumatic Life Events: A Qualitative Investigation. *Clinical Child Psychology and Psychiatry*. 2009;14(1):43–62.
- Robinson, Julia W. 2019. Preventing Youth Incarceration; Studio-Based Research," *Future Praxis: Applied Research as a Bridge Between Theory and Practice*, ARCC 2019, Toronto. <https://www.arccjournal.org/index.php/repository/article/view/603/477>
- Robinson, Julia W. and J. Stephen Weeks. 1984. *Programming as Design* (monograph). Minneapolis:School of Architecture & Landscape Architecture, University of Minnesota.
- Robinson, Julia W\_2018. Syllabus: Architecture 5212: Reconciving Juvenile Incarceration. Unpublished text.
- Robinson, Julia W. and Michael Christenson. Forthcoming. "Design Studio as Research Site: Generating Hypotheses and Test Cases," in In DeLong, M., Fisher, T., Hokanson, B., Asojo, A. & Strohecker, C. (Eds.), *Collegial Design: Thinking and Making at a Community-Engaged Universit*, Minneapolis, MN: College of Design, University of Minnesota..
- Sanoff, Henry. 1990. *Participatory Design: Theory & Techniques*. Raleigh, NC:
- Shiraldi, Vincent. 2020 *Can We Eliminate the Youth Prison? (And What Should We Replace it With?)(Executive Session in the Future of Justice Policy)*. New York: Columbia University Justice Lab. <https://squareonejustice.org/wp-content/uploads/2020/06/CJLJ8234-Square-One-Youth-Prisons-Paper-200616-WEB.pdf>
- Smith, Kelly. 2016. "Dozens rally against plans to create joint Hennepin/Ramsey juvenile facility," *Star Tribune*, December 6, <http://www.startribune.com/dozens-rally-against-plans-to-create-joint-hennepin-ramsey-juvenile-facility/405127716/>
- Underwood, Leo A., Kara Sandor von Dresner & Annie L. Phillips. 2006. Community Treatment Programs for Juveniles: A Best-Evidence Summary," *International Journal of Behavioral Consultation and Therapy* Volume 2, No. 2, Spring, 2006, p286-304

## ENDNOTES

---

<sup>i</sup> Other aspects of this studio-based research project have been discussed in several papers including Robinson, 2019, and Robinson & Christenson, forthcoming).

# Queering Arts-based Development

Laura Walker<sup>1</sup>, Mike Styczynski<sup>1,2</sup>,

<sup>1</sup>Other Work, Detroit, MI

<sup>2</sup>Lawrence Technological University, Southfield, MI

**ABSTRACT:** Emergent modes of arts-based development and occupation of public spaces in rustbelt cities are creating communities of creative capital, collective care, and social justice activism. Arts-based development and queer theory both contest social norms and explore the power struggles against heteronormative constructions of identity. "Queerscapes" deploy queer theory to reimagine human and non-human performances and interactions with space and one another. Queer theory and arts-based approaches to spatial occupation redistribute power and ownership to ultimately disrupt and transform social conventions.

Arts-based development is communalized through shared tactical and cooperative appropriation and stewardship of undervalued land by marginalized communities. As such, queer theory offers a conceptual framework to understand the nuance and complexity of alternative reclamation of sites defined by urban austerity. This paper highlights the creative strategies that arts-based communities use to reimagine normative conceptions of urbanism. We introduce a framework to understand queering and queerscapes in land-use development and examine the ways in which abandoned or privately owned sites have been queered for dwelling, learning, and performances by different communities aligned by shared values.

Creative collectives have cooperated to form interdependent, decentralized networks, allowing new types of architectural and urban forms to emerge as responsive environments. This study engaged specific organizations over a two-year period, and it evaluates how they employ queer theory to reframe normative spatial conditions and rituals. This research demonstrates how spatial aspects of queerscapes are a mechanism for the agency and liberation for oppressed identities. The intention is to serve as a guide for empowering marginalized communities through social and creative infrastructure.

**KEYWORDS:** Queerspace, arts-based, place-making, liberation, empowerment

## INTRODUCTION

For two days in August, the streets of northwest Detroit are transformed into a living stage, a "cultural living room," with experiments in street furniture that promote power and joy in public space. (Cross, 2019) Named "The Sidewalk Festival," the sidewalk and street merge, becoming a utopic scene immersed with live performances, visual arts, architectural installations, and most importantly, people of all ages, abilities, race, and backgrounds, at full liberty to be themselves and interact with the artwork. "The Sidewalk Festival" was birthed by a Black woman artist<sup>i</sup>, made possible through the arts-based development called The Artist Village. The Artist Village began 20 years ago when artists of color gathered to illegally occupy abandoned buildings for poetry readings. This ritualized event formalized into a community dedicated to alternative economic development by revitalizing abandoned post-industrial buildings to generate sustaining power for Black, lower-class residents. This intentional form of urbanization prioritized marginalized people through cooperation, alliance formation, and a radical celebration of differences.

Other Arts-based developments have formed in rustbelt, post-industrial landscapes as sites of resistance to gentrification and speculative development. These communities are oriented to alternative possibilities through the deconstruction of boundaries set in place by colonizing, white, heteronormative powers. Although their focus is not specifically to create places for the liberation and protection of sexual minorities, there is an overlap between strategies of arts-based urbanization and queer theory.

Queer theory is a critical approach that destabilizes identity categories and resituates body-community and body-city relationships by rejecting systems set in place by colonizing, cis-hetero<sup>ii</sup>, patriarchal societies. Hence, it offers a lens through which to analyze the strategies used by arts-based community and urban developers. Spatialized queer theory addresses the relationship among the various uses and enjoyment of space and the dynamics of erotic expression, power, and violence, based on diverse identities. (Ingram, 1993) Rejecting hegemonic and essentialist notions of identity, queer theory redefines ontologies of 'place' (Knopp, 2007) centered around close proximities of repeated performances that disorient and reject heteronormative notions of relating to one another.

What follows in this paper is an exploration of the ontological and socio-spatial overlaps among three post-industrial

arts-based communities through the lens of spatialized queer theory. We weave together specific strategies of alternative, arts-based urbanization with queer theory of the historicized, sexualized body and its effect on others, and “how bodies are able to forge new connections and new alliances, to forge new pleasures and new ways of being productive.” (Lim, 2007, 55) Beginning with theories of the body-identity, this paper connects and contextualizes body-identity through the body's role in community. This body-community relationship is illustrated through three specific arts-based communities in rust belt cities: The Artist Village in Detroit, Michigan; Big Car Collaborative in Indianapolis, Indiana; and Assembly House in Buffalo, New York.

## 1.0 DEFINING QUEER THEORY

The following summary of theories are sourced from geographers of sexuality, feminist and gender studies, and philosophers, to identify lines of inquiry for a productive and generative discourse on the spatialization of queer theory. Post Stonewall Riots and during the AIDs epidemic in North America in the 1980s-1990s, much of the academic discourse surrounding geographies of sexualities focused on the recognition of identities and rights of gays and lesbians and celebrated contested sites occupied by these non-heterosexual identities. In the early 2000s through today, critics of queer theory argue for an expanded analysis, since sexual identity is only one aspect which is mutually constituted with other identities shaped by heteronormative practice. Therefore, queer theory critiques “the class, race and gender specific dimensions of homonormativities<sup>iii</sup> and heteronormativities” (Oswin, 2008, 96). Additionally, the focus on identity itself has been problematized, because the recognition of new or alternative identities “involve a negative difference from another identity, even in the pursuit of becoming ‘an other of the Other’” (Lim, 2007, 63). Similarly, queer theory interrogates constructs of identity, imagining not what bodies are, but rather what bodies ‘can do’ and seeks to create sites of resistance against dominant powers.

Judith Butler's ideas of gender identity as performance and Sara Ahmed's queering phenomenology has shifted focus away from identity towards models of production (Grosz, 2009). These models examine the role of desire as a productive force, impacting how bodies can affect one another. Incorporating Deleuzian theories of affect, spatialized queer theory examines spaces of support and proximity for new assemblages and experiences (Ahmed, 2006; Crawford, 2010; Lim, 2007; Gough, 2017). Balanced in tension with this radical pursuit of what bodies can do, queerness not only explores methods of resistance and dissent, it also “underscores contingency and complicity with dominant formations.” (Puar, 2005, 121) To explore this complex relationship among resistance, complicity, and possibilities through assemblages, we first need to define the role that the body-as-object plays in community or in queer spaces, as the body and its subjectivity (even as an object) is the mechanism for disruption.

### 1.1. Queer theory of the body

For many queer, Black, Indigenous, and other people of color (BIPOC)<sup>iv</sup>, the idea of home is charged. Often BIPOC do not feel at home even in their own skin for many reasons related to misaligning with a White, colonized, heteronormative society. Decolonizing gender identity requires a rejection of individualistic, binary notions of identity by reuniting the mind with the body as one complete whole, an intertwined production. This is integral to the understanding of queerness, as the task is to reconnect the self-determined body to its capacity to affect others outside the realms of binary and heteronormativity. When the gender binary is deconstructed, “we cannot talk about an ‘inner’ conception of gender vs. an ‘outer’ physical body.” (binaohan, 2014, 35). This de-essentializes gender and supports a “return to the plane of consistency, the location where all dichotomies are dispensed with, where everything ... exists on the same level without hierarchy...” (Gough, 2017, 7) This reasserts the value of Indigenous, non-binary gender roles<sup>v</sup> and redefines the body not as a sexed or gendered home, but as an archive open to the Deleuzian experience of becoming and transforming.

### 1.2. Queer theory of events and sites

The body's relationship to its physical environment is defined by its mutually intertwined production with the environment and with other bodies. (Grosz, 1992, 242) As gender and sexual identity becomes de-essentialized, desire, as a productive force for entering into relations, stems not from fixed identities, but rather from bodies as objects. As such, desire is liberated from the constraints of identity (Lim, 2007). However, feminist critique of Deleuzian theory claim it is impossible to define the body as only an object. This reinforces subjectivity, since bodies do not possess the same amount of capacity for action compelled by desire. As Franz Fanon describes, “bodies are shaped by histories of colonialism, which makes the world “white” as a world that is inherited or already given.” (Ahmed, 2006, 111) For non-White bodies born in a White world, there is a sense of place and belonging as the body's racialization is a pre-existing inheritance.

The fundamental ability to own one's body, including its gender and sexual determinations, has been a violent battle for BIPOC bodies since the invasion of European colonizers in the 16th century. The capacity for BIPOC to fully express their gender and sexual identity is affected by the very fact that they are non-White. The gender binary was weaponized against Black and Indigenous bodies, requiring “that blackness only be granted ‘gender’ insofar as it meant reproduction of property.” (binaohan, 2014, 79) To overcome, or at least address, that one's body and its orientation do not align with White, heteronormative orientations requires a social, collective effort which “allows us to rethink desire as a form of action that shapes bodies and worlds.” (Ahmed, 2006, 102) Communalities are developed through shared desires

and common orientations, and they are crucial to support those who are othered. These supportive spaces become sites of proximity that promote contact, becoming “a common plane of immanence on which all bodies, all minds, and all individuals are situated.” (Gough, 2017, 8) In recognizing that not all capacities are similar and that repetitive performances of self are impacted by relations to others, there is still the open possibility to enter into reparative forms of relations through these assemblies and assemblages. This reparative stance “is additive and accretive. ... It wants to assemble and confer plenitude on an object that will then have resources to offer to an inchoate self.” (Sedgwick, 2003) Such assemblages, although focused on productive modes, also need to consider the complexities of nourishment, resources, comfort, and pleasure in how relations are fostered. (Lim, 2007)

The focus on assemblies opens the possibility for non-binary and unprescribed relationships among people, objects, and architecture. The “assemblage, as a series of dispersed but mutually implicated networks, draws together enunciation and dissolution, causality and effect.” (Puar, 2005, 127) Instead of centering identity or even intersectionality, an assemblage is a collaborative plane that mediates interwoven forces and affectivities across bodies to dissolve bodies into one another. (Puar, 2005; Gough, 2017) The focus shifts towards events, transformations, and constant evolution as a collective experience through proximity and intensity.

### 1.3. Heterotopia

Scholars of queer and feminist theories have compared queer communities to Michel Foucault’s ideas on ‘heterotopias’ as sites of deviation or crisis against heteronormativity, managing ‘otherness’ by bringing together seemingly oppositional, diverse people and ideologies. (Foucault, 1984) These counter-sites are real, localized places bound by time as archives and networks of intervention and influence, “in such a way as to suspect, neutralize, or invent the set of relations that they happen to designate, mirror, or reflect.” (Foucault, 1984, 3) Heterotopias function in the rest of society by reflecting and disrupting it. Access to these enclaves of multiplicitous spaces within a heterotopia is restricted as a tactical exclusion which serves to protect and support the agendas of certain ‘others.’

With exclusive enclaves hedged within them, heterotopias still engage with the dominant structures of heteronormative, capitalistic societies, in a tactical way that redistributes power and ownership. The ever changing, temporal quality of heterotopias still has lasting effects that erode at the binaries established outside their porous, layered boundaries. Although they fluctuate over time, their permanence of spatial reclamation engages and critiques heteronormative society. (Cottrill, 2006)

## 2.0 METHODOLOGY – CASE STUDY ANALYSIS OF ARTS-BASED DEVELOPMENT

The primary way that queer theory is spatialized is through assemblages and heterotopias, and how these are tied to affectivity, the archive, and reparative transformation. The following discussion of three case studies of arts-based communities explores how each one spatializes queer theory. These communities are amorphous, incomplete, and emergent. Although they have utopian qualities, they engage with heteronormative institutions and systems to transform them. As architects and artists, we have formed relationships by gathering stories, designing and constructing spaces, and diagramming their processes for alliance formation and economic structures. We will note that we have participated in the design and installation of a storefront space for civic use within Case Study 3, the Artist Village. Going beyond repurposing or renovating a historic building into a new typology, such as an old church into a brewery, arts-based communities are reconstituting a value system that transforms something once discarded into a life-sustaining, economic force for a people who for centuries have fought for ownership of their own bodies. Contrary to instilling a ‘sense of place’ through ‘placetaking approaches’ (Starowitz & Cole, 2015) of gritty art murals, which has become a mechanism for gentrification, these spaces redefine what ‘home’ could be for people that have lost their place.

To achieve this, these communities are navigating the financial process, zoning ordinances, and building codes and are mitigating speculative development. Since gentrification is a constant risk of community improvement involving artists and art, there can be the presupposition that harmful displacement is a possible outcome. But in the words of Alicia George, “Gentrification, that’s a tricky word. So is being a Black woman in this country.” (George, 2020) The risk of gentrification has been suspended, because those leading and benefiting from these arts-based communities are not the dominant identities.

### 2.1 Case study 1 – Assembly House 150

In 2007, Buffalo initiated the “5 in 5” Demolition Plan, demolishing over 5,000 vacant homes in five years. Dennis Maher - architect, artist, contractor - took on demolition jobs to immerse himself in this context of rapid erasure, intense change, and the disappearance of memories. This led to experimentation in artwork as ‘memoriam,’ where room-size sculptural installations from demolition detritus embraced instability and change. Maher reclaimed an abandoned house which would become his own home, the Fargo House, turning it into a space for diverse groups of people to hold workshops and discussions related to home, restoration, and city change. As his installations and home provoked new ways of considering the built environment, he fostered relationships with trades people, builders, developers, and artists.

Dennis Maher formed Assembly House 150 in 2012 through a collaborative artist-in-residence project commissioned



by the Albright Knox Art Gallery. After acquiring a vacant 1860s catholic church, he launched the trade skills training program SACRA (Society for the Advancement of Construction Related Arts) with the Albright Knox Art Gallery and the County's Department of Social Services, which helped recruit students. This program led to more grant support which facilitated both the programming and the restoration of the historic church. The primary goal was to create a space that brought together artists, trades people, and builders for large-scale collaborative projects. The church displays the work created by students, offering a variety of spaces for instruction and gathering. Eventually, Assembly House could provide contracting services for projects in the community, which generates revenue and creates in-field learning experiences for students.



**Figure 1:** Photograph of Assembly House 150

A valuable piece in this community is the repaired relationships among artists, trades workers, architects, and unions of organized laborers. “We just had two amazing young Black women who finished our program and another in the mayor’s pre-apprenticeship program in the painter’s union.”<sup>vi</sup> Together, the heterotopic site of the church and the SACRA program support a reparative stance towards relationships formed among people and spaces in disadvantaged neighborhoods. The archive is the mechanism for this reparative stance, embracing the effects of differences and other perspectives. The archive is introduced as a pedagogical instrument in the training course, working its way in many aspects of Assembly House 150. The first project has students design and build a container that is custom fitted to hold a common building tool, such as a hammer, saw, or wrench. The tool’s form, weight, and shape are archived into the box. The archive is used to provoke ways of understanding and expressing the various ways objects can be deployed and transformed.

The church is now filled with artifacts, installations, and memoirs of architecture and craftwork. Assembly House 150 makes art accessible to working-class people as a hinge for impacting the construction industry. The former altar is a workshop for training students in construction, design skills, and traditional craftsmanship. Students are residents from underemployed communities and formerly incarcerated people, most with limited opportunities for livelihood. Once a liability in the neighborhood, the church is now a space for workforce development focused on celebrating the value of people needing a second chance. Symbolically, where the body of Christ was ritually transubstantiated became the place, or home, for a found family of people transforming themselves, one another, and objects through fabrication and making as a process of becoming, of unbecoming, of folding and refolding new existences. The church is archived as a new home, and houses other archives, while the people within archive their immanent relationships to creative work.

As an archive, the church is a body under constant renovation, morphing to create new experiential effects. A museum of archives, the church displays original blueprints of historic buildings; exhibits of laser cut models of buildings and artifacts; moveable platforms and spaces; traditional building components re-interpreted and unconventionally deployed. This builds on the idea of the body as archive, requiring “a different kind of care, a self-reflexive fashioning and continuous crafting rather than a static having and holding.” (Crawford, 2010, 532) The human body does not need medicalized surgery to match the ‘outer self’ to the ‘inner self’ by complying with or ‘passing’ by White, transmisogynist standards of gender identity for trans individuals. (binaohan, 2014) Likewise, participants in Assembly House 150 and

the SACRA program are interdependent agents in this assemblage, focusing on their capacity to create rather than their past identities. Together they renovate the church, the students' futures in the workforce, the construction industry, and historic buildings across a post-industrial rustbelt city. The openness to constant flux allows collaboration across industries, resisting the notion of sole 'sovereign power' towards an idealized, complete state. (Crawford, 2010)

## 2.2 Case study 2 – Big Car Collaborative

Formed in 2003, Big Car Collaborative is a non-profit organization in Indianapolis, Indiana that supports artists through social-based arts programming and an artist-in-residency program. 15 buildings in one mixed-use block consists of: The Tube Factory, an industrial building converted into a contemporary art museum which doubles as a community space, a radio station, Listen Hear, and single-family homes. A 3,716 m<sup>2</sup> (40,000 ft<sup>2</sup>) factory will soon house studios and performance space. The neighbourhood of Garfield Park is their second home; the first was in Fountain Square, in which they now admit they were unwittingly a tool in gentrification, ultimately contributing to their own displacement. Since then, Big Car prioritizes affordable housing for the creative class, as those “who are willing to take risks and think of the world in a different way.” (Marsh, 2020)

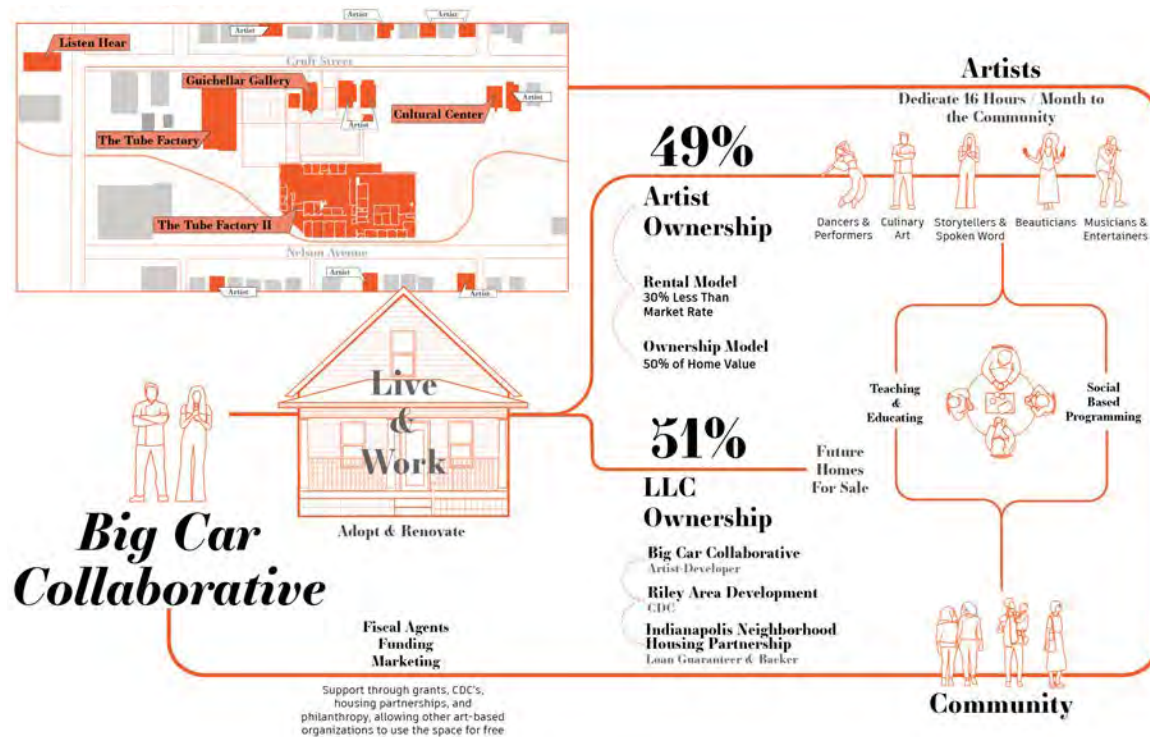


Figure 2: Big Car Collaborative Network

Realizing that community assets and socially focused programming are not enough, they now use intentional place-keeping, tactical urban strategies. The non-profit programming aspect is paired with a development arm by partnering with local financial and developmental organizations. Called the Artist and Public Life Residency (APLR), Big Car uses a land trust model by purchasing, renovating, and selling a 49% share of each affordable home to an artist of color or working-class artist. However, when many of the applicants struggled to attain small loans (~\$40,000), Big Car pivoted, making them affordable rent-to-own homes. This gives artists of color opportunities to invest in the community and their creative work while Big Car addresses the discriminatory challenges in the banking system. The goal was to increase ownership for both artists and Big Car. Big Car took a reparative approach by giving artists home ownership who were dismissed by a discriminatory financial system. Currently, they have 19 families that are part of the APLR, 13 of which are Black artists. In this rent-to-own arrangement, artists commit to working 16 hours per month within their practice in the neighborhood and are given a \$5,000 stipend for their creative work. By working within the system, Big Car established a heterotopia as a site of resistance that has spatial impacts.

Selected resident artists become “co-leaders” to address social challenges and strengthen the neighborhood with their work. (Big Car Collaborative, 2020) Culinary artists, furniture makers, videographers, performing artists, journalists, architects, and so many other creatives of color and other marginalized people have hosted free programming which has material outcomes for the neighborhood, increasing accessibility to art and its impact for change. Since single family homes have historically operated to reinforce heteronormative gender roles, they are often an explicit site of

trauma for BIPOC and queer people. Big Car is restoring a sense of home and ownership for people who may have tenuous relationships with this idea of home, by instilling authorship and ownership in a community of lower-class creative residents. Binaries, boundaries, and limitations give way to a 'plane of consistency' that facilitates desire-informed assemblages of multiplicity and difference through cross-disciplinary collaborations. Reparative measures increased the capacity of disadvantaged artists to enter into new relations with one another and the community.

What is particularly queer about Big Car is that formerly 'subordinated' or 'othered' creative beings are given uncensored and free agency to create "sites of exception" (Ingram, 1993, 10) as moments, places, and events that have socio-political impacts within their own neighborhood. This heterotopia deploys tactical exclusion, working with residents to organize resistance through the appropriation and use of space as a "segregated culture of opposition" (hooks, 1990, 235) to displacement by capitalism and speculative development. This intervention sets in motion 'immanent change', open to affective and material forces that create a feedback loop between artist and events. (Lim, 2007) They are "assembled together according to relations of proximity and interplay, passion and affect, symbiosis and a-parallel evolution." (Gough, 2017)

### 2.3 Case study 3 – The Artist Village

The Artist Village is situated in the furthest northwest corner of Detroit in a neighborhood called Old Redford. This location is germane to its formation and development because the geographical size of Detroit is vast at 370.1m<sup>2</sup> (142.9 ft<sup>2</sup>). A bus ride from Old Redford to Downtown Detroit is one hour, hence municipal services and oversight are inaccessible for many in Old Redford. Alicia George, co-founder of The Artist Village, had the mission to serve the safety and welfare of her community through art.

The Artist Village was born in 2003 when a "NO DUMPING" sign was posted in a dumping ground of abandoned lots in Old Redford. By staking claim and asserting value, new possibilities were imagined. Resident artist and cofounder Chaz Miller painted butterflies on walls, grounds, and structures to signal spaces available for people to create. This act was named the "the butterfly effect" to signify rebirth and to disrupt the course of former industrial sites, giving authorship to community members. The Village reconstitutes new ontological possibilities of inhabiting space through deconstructing presumed notions of identity, value, and purpose. By creating a place of contingency and proximity, each member contributes to the transformation of this community. Their artwork becomes an assemblage as part of a strategic development that generates power and a new type of economy for lower class, Black residents.

An open mic poetry series ran for 10 years, "to raise awareness, dollars, and, of course, let the artists do what they do." (George, 2020) The Village grew into a community center that cultivated creativity in residents. After the roof of one of the buildings caved in, they could not afford to repair it, so they removed the roof entirely, naming that space The Room Without a Roof. Vendors came from to use this novel space and build their clientele, generating revenue without the costs of a brick-and-mortar space. As the Village grew, so did its reach as a micro-city of creativity. The Sidewalk Festival, which had its seventh annual festival in 2019, was born through the supportive 'plane of consistency' of the Village. Small businesses flourished, and residents learned creative, life-sustaining skills to build community power.

The Village's boundaries and extents are undefinable as a place and entity. It is a labyrinth of rooms and buildings saturated in artwork, constantly evolving through the work of artists and residents. The entry point is a coffee shop, connected to a gathering space that hosts local elected officials, block club meetings, and jazz nights. Beyond the coffee shop is an exterior courtyard, which connects to the gallery space where local artists work and exhibit their artwork. Adjacent is the Studio, a larger room for community events. Next is the Room without a Roof, surrounded on all four walls with murals. The 360-degree murals are ever changing, but always tell a story, whether of rebirth or other narratives of Detroit and Black history. Vegetables grown in the community garden are used by the Village and residents. Above the coffee shop is a Bed and Breakfast for resident artists. Surrounding all these spaces are buildings, some vacant, with unprescribed futures. The spaces and their uses are in constant flux, always in a state of becoming and unbecoming.

When a local developer bought a historic building with the weight of legacy and sentimentality attached to it in Old Redford, they first approached the Village. With community support, the developer conscientiously repurposed the building as mixed-use, with tiered lease agreements for entrepreneurs on the ground floor and lofts above as affordable housing. Old Redford residents named the building The Obama Building during a community block club meeting at the Village, celebrating the portraits that Chaz Miller painted of Barack and Michelle Obama, which had been displayed on the building for several years. Because of the power generated by the Village, the residents could influence the architecture, lease arrangements, and programming of the building. Although the architects hired were from another state, both the architects and developer worked cooperatively with the Village by way of entering their heterotopia.

Like Big Car Collaborative, the Artist Village is a heterotopia that engages the heteronormative systems around it, both to deviate and to influence. As a very discreet instance of this interface, The City Planning and Building Department invested in a satellite location at the Village for city government employees to be more accessible to residents. The



Village's goal was to humanize the spirits of city government employees, so they would "communicate and translate to the City on what it is that we need as a community." (George, 2020) The impact of municipality presence on the community was profound. This would have been a much less impactful relationship between civic institutions and residents without the transformational nature of the Village. This "one-stop-shop" fostered a reparative stance between the community and the city government, inspiring Summer Camps; grant writing; pop-up shops; classes that helped women with low birth rates; and help with property taxes and home-ownership issues.

When the large box grocery retailer moved into Old Redford, it complied with the Village by an unofficial community benefits agreement, investing \$33 million into the neighborhood and giving jobs to 300 residents. (George, 2020) After years of protecting and serving artists, it no longer matters whether someone is a city government employee, or whether the artist/architects are White outsiders, or whether an outside developer purchases a historic legacy building within the community. What matters is those who enter this heterotopia operate by its rules, serving its needs. Power is held by the residents of Old Redford, giving them access to jobs, housing, and skills, in addition to authorship over the architectural and urban design improvements.

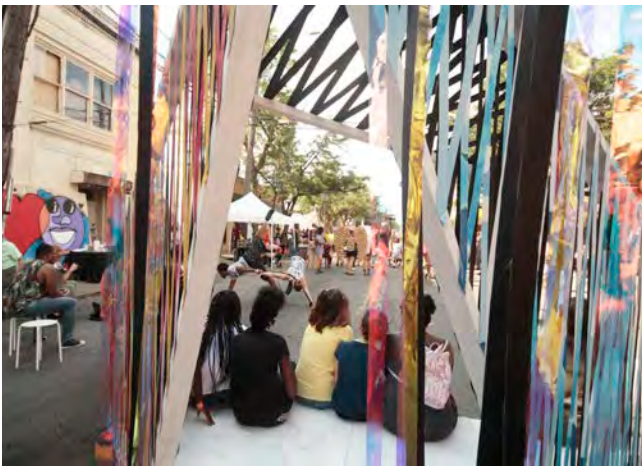


Figure 3: Photograph of Sidewalk Festival.

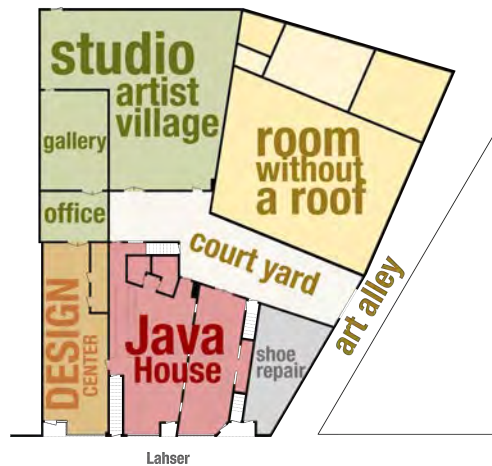


Figure 4: Current Plan of The Artist Village

## CONCLUSION

These three arts-based communities intentionally use art as a mechanism for reclaiming power for people who have been 'othered' or marginalized in a White, heteronormative society. The openness to collaborative participation by anyone, no matter their background, is leading to unimaginable new ways of living and being. Even when asked what the future holds or what the ultimate goal is for their community, these artist developers only prioritize that their community shapes the future. To do this requires a reparative stance towards relationships that formerly held trauma, oppression, or insecurities, whether it was the relationship towards home, livelihood, differing roles in the building industry, or municipalities. It requires acknowledging that not all bodies have the same capacity to affect others. Just as queer theory seeks to protect and liberate sexual minorities, healing the harm caused by homophobia and transmisogyny, these arts-based communities are serving, empowering, and protecting working class, Black, Indigenous, and other people of Color, Queer, dis/abled people by supporting their creativity. "The people of the community that stand up, we have the power. All we have to do is activate it." (George, 2020)

## ACKNOWLEDGEMENTS

The authors gratefully acknowledge the artist developers who have graciously given us their insight during interviews, tours, field work, and conversations: Alicia George of The Artist Village in Detroit, for welcoming us into her home and being incredibly authentic and loving in all she does; Shauta Marsh and Jim Walker of Big Car Collaborative, for their authenticity and vulnerability in sharing their journey and aspirations; Dennis Maher of Assembly House 150, for welcoming us into his home and for his obsession with archiving beauty.

## REFERENCES

- Ahmed, S. (2006). *Queer Phenomenology*. Duke University Press.
- Big Car Collaborative. "Affordable artist housing." February, 2020. <https://www.bigcar.org/project/aplr/>
- binaohan. b. (2014) *decolonizing trans/gender 101*. biyuti publishing.
- Cottrill, J. (2006) *Queering Architecture: Possibilities of Space(s)*. Miami University, Department of Architecture.
- Crawford, Lucas. "Breaking Ground on a Theory of Transgender Architecture." *Seattle Journal for Social Justice*, Volume 8. (Spring/Summer 2010): 515-539.
- Cross, LaToya. "For 7th Annual Sidewalk Festival, Old Redford Becomes Street Art Utopia." WDET. WDET's Detroit Storymakers, July 29, 2019. <https://wdet.org/posts/2019/07/29/88438-for-7th-annual-sidewalk-festival-old-redford-becomes-street-art-utopia/>.
- Foucault, M. "Of Other Spaces: Utopias and Heterotopias." *Architecture/Mouvement/Continuité*, (October, (1984) [1967])
- George, A. & Styczynski, M & Walker, L. (2020, September 14). *Artist as Developer* [Panel Discussion], Detroit Month of Design, Virtual Webinar. <https://youtu.be/xflYlOfWyg>.
- Gough, Tim. "Trans-Architecture." *Footprint Journal*, Volume 11. No. 2 (Autumn/Winter, 2017): 51-66. <https://doi.org/10.7480/footprint.11.2.1900>
- Grosz, Elizabeth. "Bodies-Cities." In *Sexuality and Space*, edited by Beatriz Colomina, 241-254. New York, NY, Princeton Architectural Press, 1992.
- Grosz, E. (2009, May 19) A discussion as part of the Former West project, *Centre for Humanities*, Utrecht University, Utrecht. <https://www.youtube.com/watch?app=desktop&v=V-sAE5GDiQg>
- hooks. b. (1990) *yearning: race, gender, and cultural politics*. New York, NY, Routledge.
- Ingram, G. B. "Queers in space: Towards a theory of landscape and sexual orientation." Presented at the Queers in Space I Panel of the Queer Sites Conference, University of Toronto, May 1993.
- Knopp, Larry. "From Lesbian and Gay to Queer Geographies: Pasts, Prospects and Possibilities." In *Geographies of Sexualities: Theory, Practices and Politics*, edited by Kath Browne, Jason Lim, Gavin Brown, 21-28. Surrey, England, Ashgate Publishing Ltd, 2007.
- Lim, Jason. "Queer Critiques and the Politics of Affect." In *Geographies of Sexualities: Theory, Practices and Politics*, edited by Kath Browne, Jason Lim, Gavin Brown, 53-68. Surrey, England, Ashgate Publishing Ltd, 2007.
- Marsh, S. & Styczynski, M & Walker, L. (2020, September 14). *Artist as Developer* [Panel Discussion], Detroit Month of Design, Virtual Webinar. <https://youtu.be/xflYlOfWyg>.
- Oswin, Natalie. "Critical Geographies and the Uses of Sexuality: Deconstructing Queer Space." *Progress in Human Geography*, Volume 32. (February 2008): 89-103. <https://doi.org/10.1177/0309132507085213>.
- Puar, Jasbir. "Queer Times, Queer Assemblages." *Social Text*, Volume 23. Nos. 3-4, (Fall-Winter 2005): 121-139, Duke University Press. DOI: 10.1215/01642472-23-3-4\_84-85-121
- Sedgwick, E. (2003) *Touching Feeling: Affect, Pedagogy, Performativity*. Duke University Press.

## ENDNOTES

<sup>i</sup> Ryan Myers-Johnson, Sidewalk Detroit

<sup>ii</sup> Cis-hetero is a term that combines cis gender and heterosexuality. Cis gender is a term for those who identify with the sex assigned to them at birth

<sup>iii</sup> Homonormativity is the practice of asserting heteronormativity onto queer people, privileging cis-gender, monogamous couples for social acceptance.

<sup>iv</sup> BIPOC is an acronym that stands for Black, Indigenous, and other People of Color, which includes people that do not identify as White bodied. This acronym is used throughout this paper.

<sup>v</sup> Indigenous gender roles held significant positions of spiritual and community leadership. Part of colonization was removing these gender roles associated with leadership by asserting the gender binary.

<sup>vi</sup> Dennis Maher, in Zoom conversation, September 8, 2020

# The New Stewards: How Non-architects Shape Public Understanding and Decision-making of the Built Environment

Irene Hwang<sup>1</sup>

<sup>1</sup>University of Michigan, Ann Arbor, MI

**ABSTRACT:** With the rise of the internet, social media, and streaming content, the amount of information regarding architectural thinking and making is more commonplace and accessible than ever before. As resources dwindle and populations grow, pressures of overcrowding and climate change demand that as a society, we make more-informed, well-considered decisions about our shared, built environment. This paper describes the difficulty of meeting that demand, positing that architects' and architecture's capacity to steward better outcomes is limited because non-architects have more power to shape society's concerns and priorities for the built environment than do architects. This paper charts how the protagonists of traditional and new media have become the genuine shapers of public opinion, thereby shifting oversight and responsibility of the built environment from architects to non-architects.

**KEYWORDS:** Media, single-family, public opinion, built environment

## INTRODUCTION

With the rise of the internet, social media, and streaming content, the amount of information regarding architectural thinking and making is more commonplace and accessible than ever before. As resources dwindle and populations grow, pressures of overcrowding and climate change demand that as a society, we make more-informed, well-considered decisions about our shared, built environment. This paper describes the difficulty of meeting that demand, positing that architects' and architecture's capacity to steward better outcomes is limited because *non-architects* have more power to shape society's concerns and priorities for the built environment than do architects. Through three exemplars this paper charts how the protagonists of traditional and new media have become the genuine shapers of public opinion, thereby shifting oversight and responsibility of the built environment from architects to non-architects.

More specifically, this paper considers the power of public opinion to shape and determine the built environment, as well as presents how new and traditional media figures have become the determinants and drivers of design education and indoctrination at a massive, societal scale. The paper also introduces the concept of *Spatial Narcissism*: whereby the value and benefit of architectural expertise is distorted and convoluted when conflated with the "expertise" of non-architects. Lastly, this paper explores the perceived value of architects and architectural expertise, in light of American exceptionalism and its role in shaping the American psyche. In particular, how have anti-intellectualism and neo-liberal individualism come to determine individual preferences in matters of taste, housing tenure, and public policy? How do individual preferences turn into acts and decisions, which in aggregate and at scale, combine into a force that downplays and dampens architecture's and architects' agency to benefit the built environment.

The research follows a mixed-method of critical narrative inquiry combined with historical analysis to contextualize the examination of exemplars, presented as anecdotal evidence of "new stewardship" in architecture and the built environment. Through these exemplars, this author hopes to touch upon a set of ideas that are by no means exhaustive, but to shed light on the rise of these New Stewards.

## I. CELEBRITY OPINION IS THE NEW EXPERTISE

The phenomenon of celebrity has a long history (Furedi 2010). Celebrities have long functioned as aspirational models; individuals gained fame and recognition because they had exceptional skills, wealth, or power, either earned or inherited. Yet, by the end of the 20<sup>th</sup> century and beginning of the 21<sup>st</sup> century, with the rise of reality television and social media platforms, scholars have noted a shift in the character of celebrity (Furedi 2010, Gamson 2011). Where previously the path to celebrity had been marked by exceptional capacity, talent or achievement, there now exists a new type of celebrity: a person who is both *exceptional* and also completely ordinary, *just like everyone else*. "[C]elebrity culture is increasingly populated by unexceptional people who have become famous and by stars who have been made ordinary" (Gamson 2011).

Today, celebrities who display their exceptional talents or their tremendous spheres of influence to the public, are also



sharing the mundane and commonplace aspects of their lives with the same audiences. Social media has structurally changed the nature of celebrity by exponentially increasing the level of intimacy and exposure between the celebrity and their fans. The once large expanse between celebrity (a person with power or exceptional talent) and everyone else (those without power or exceptional talent) is vastly decreased. With the totalizing rise of social media technology and use, celebrity today is an even more powerful device of social connection. The extraordinary becomes everyday, and thus, relatable and intimate. In our social-media-connected society, the views and recommendations of celebrities, whether they are experts or not, hold a potent and influential role.

The resultant relationship developed between celebrity and society further intensifies via “parasocial relationships” (Horton & Wohl, 1956). Parasocial relationships form when “a media persona and individuals develop a sense of intimacy, perceived friendship, and identification” (Horton & Wohl, 1956, Lueck 2015, Chung and Cho, 2017). In their study on parasocial relationships and social media, Siyoung Chung and Hichang Cho describe: “Opportunities for interactions with celebrities in the past were rare and carefully controlled by celebrities for publicity and promotion purposes. However, social media have changed this one-sided relationship to a more interactive and reciprocal one” at scale and en masse. (Chung and Cho, 2017). Meta-analysis has revealed that ongoing engagement through parasocial relationships leads fans/followers/audiences to attribute a rise in trustworthiness to the celebrity. So that in the case of celebrity endorsement, “source trustworthiness has a greater weight on attitude change than source expertise” (Amos, Holmes, and Strutton, 2008, Chung and Cho, 2017).

Here, ordinary citizens not only count on celebrities to share their advice on aspects of daily life, but they trust these recommendations as sound and solid. Through mass and interpersonal communication methods “celebrities naturally turn into opinion leaders when tweeting or posting.” (McClelland 2011, Lueck 2015). In the same way that you’re more likely to trust a friend’s restaurant recommendation, fans who consider celebrities to be a kind of friend (when literally “friended” on social media) and are more apt to trust celebrity recommendations and opinions as much as those of family or friends. In the contemporary environment of celebrity, knowledge and expertise become interchangeable and indistinguishable.

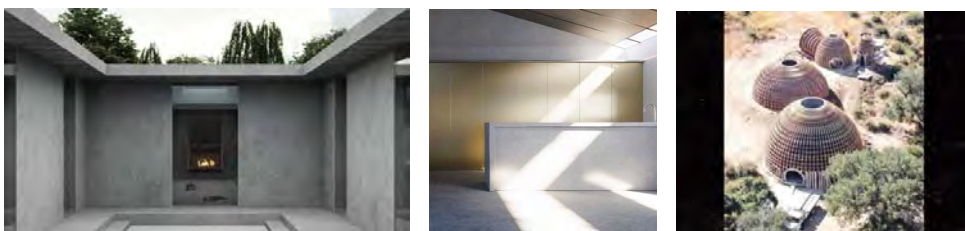
This trust, when examined in the context of architecture and the built environment, can have a tremendous impact upon how individual behavior and attitudes are shaped in relation to the built environment. Celebrity opinion and endorsement is not just a matter of shaping consumer behavior for products. Rather, at the scale of the built environment, I posit that the role of celebrity endorsement and opinion, through its massive reach and spread via amplified parasocial relationships forged on social networks and through the internet, has and will continue to reinforce attitudes and motivating beliefs about our shared built environment that are more destructive rather than productive, selfish rather than generous, and wasteful rather than high performance.

### Yeezy Home

On May 6, 2018, Kanye West announced on Twitter: “We’re starting a Yeezy architecture arm called Yeezy home [sic]. We’re looking for architects and industrial designers that want to make the world better.” Founded as a fashion brand, West started Yeezy (a name derived from a nickname given to West by fellow musician and producer Jay-Z) with a shoe line in 2009. By 2018, the brand was anticipated to bring in a yearly revenue of \$1.5 billion, with West drawing an anticipated \$150 million in pre-tax income that year.)

Five years after his spontaneous and well-gossiped-about “drop in” to meet and speak with Harvard GSD’s African American Student Union (AASU), Kanye had then shared with students, “I really do believe that the world can be saved through design, and everything needs to actually be ‘architected.’ [...] I believe that utopia is actually possible,” West officially Twitter-declared in a message to his millions of social media followers that architecture was next for the Yeezy brand empire.

Over the next two years with West at the helm, Yeezy Home began to offer design visions. That summer of 2018, the brand released a design scheme for low-income housing. Reported by Hypebeast, the online “source” dedicated to “men’s contemporary fashion and streetwear,” West’s “low-income housing scheme is intended to be constructed of prefabricated concrete components.” In the comments below, one user with the handle “The Gramps” is the first to post the thoughts: “Nothing to hate about this one. At least he is trying to help people.”



**Fig. 1:** Yeezy Low Income Housing + **Fig. 2:** Yeezy Home, Interior Rendering + **Fig. 3:** Housing for people who are homeless

Upon reviewing the initial renderings of the proposal, one view features a Zen-garden-esque courtyard, complete with rocks and gravel ready for the raking, as well as a glimpse to the space beyond: a more enclosed, inner courtyard with a gas-burning fireplace feature-wall. Next in the line of dozens and dozens of comments, user “Tahoe Seventeen” writes in response to “The Gramps:” “I’m waiting to see which people he’s trying to ‘help’ because this doesn’t look like your typical low-income housing.”

Dubbed by Kanye as the “Social Housing Project,” I contend that this project, along with Yeezy Home’s second housing proposal, a series of domed structures for people who are homeless (inspired by the Stars Wars set design of Luke Skywalker’s homestead on Tatooine) demonstrate a colossal (even if well-intentioned) backfiring. This backfiring illustrates the gap in the American psyche: where expertise and knowledge is overshadowed by skin-deep, non-expert opinions. This gap, between expertise and opinion, is rapidly shrinking and resulting in pseudo and superficial understandings of architects and architectural design growing not only in prominence, but also in influence.

The implication is that this growing body of architectural pseudo-expertise, ever more accessible and available to millions of social media followers (in Kanye’s case, upwards of 35 million to date combining Instagram and Twitter), has a profound part in the shaping of the built environment, through the influencing of the public’s desires and the public’s priorities. These desires and priorities are shaped 24-7. The continuous interactions and uninterrupted sharing blur the distinctions between celebrity <> fan, as well as good advice <> marketing. Once the boundaries fall away, the capacity to distinguish between expertise <> opinion becomes moot.

### Without Basins



[Fig. 4: Kardashian West Home] + [Fig. 5: No Basin Sinks] + [Fig. 6: Forbes Cover with Kim Kardashian]

In April 2019, having described their home as a “minimal monastery” during a widely publicized and disseminated Vogue Magazine video tour, Kim Kardashian West explains to her follower-fans (nearly 200 million on Instagram) that the Kardashian-West family’s sinks, which lack a basin, are the result of Kanye’s design sketch and “8 versions of [a] prototype.” These examples are touted as “architecture,” not only by West, but also by his and Kim’s huge community of fans, as well as hosts and presenters in the entertainment news media. Basin-less sinks, a rarefied luxury only remotely feasible in a family home with dozens of other sinks and staff to perform the household tasks required of sinks-with-basins, are normalized at the Kardashian-West’s house, and subsequently in the minds of their nearly quarter billion followers.

In an August 2019 Forbes Magazine profile, media and entertainment journalist Zack O’Malley Greenburg foregrounds West’s part in designing his house:

*The lushly landscaped exterior of the property he shares with his wife, Kim Kardashian West, and their four children (North, Saint, Chicago and Psalm) serves as stark contrast to the unadorned alabaster walls within. Nearly every surface is a monastic shade of white. The floors are made of a special Belgian plaster; if scuffed, the delicate material can be repaired only by a crew flown in from Europe. “The house was all him,” Kardashian West later tells me. “I’ve never seen anyone that pays such attention to detail.”*

O’Malley Greenburg’s celebration of West’s obsessive attention to detail and hyper-expensive, hyper-rarefied interior finish choices creates an equivalency between taste and expertise. It takes only five sentences at the start of the article to reinforce West as a legitimate and credible architectural and design expert based solely on West’s personal connection to architecture. Olivier Driessens, a scholar of digital media and social theory, terms this phenomenon “migration,” where celebrities use their social status and social capital to not only gain profit (i.e., fame = money), but also to, “develop other professional activities either within their original field or to penetrate other...fields.” Earlier, celebrity arose from either the possession of exceptional innate qualities or remarkable achievement. Now, that model has evolved from an *achieved* model of celebrity to now the model of *attributed* celebrity. (A shift that is reflected in the ongoing public fascination regarding Kim Kardashian’s fame without “talent.”) Driessens also explains that as celebrity itself is proliferating and diversifying through the absolute and massive increase in the amount of media platforms, the result is that more and more people are given a forum, even those without specific talents. (Driessens 2012) This shift

results in the “striking visibility of ordinary people in the media and the potential role of celebrity in everyday life.” (Turner 2006) With celebrity status there not only comes profit, but it can also bring power. In the extreme case, such as Ronald Reagan or Donald Trump, celebrity can be converted into tremendous political power. In the case of Kanye West, his status as a celebrity *artiste* allows him to flow frictionlessly between activities in many different creative fields. By nature of West’s celebrity, society no longer sees the different between architectural hobbyist and licensed architect; the person that makes great music can just as easily make great architecture.

In 2012, when Driessens wrote his article on the celebritization of society and culture, he describes what he considered then to be limits to celebrity migration:

*There are also limits for the celebrities themselves regarding migration into other social fields. While entertainment and sports celebrities can make statements about some topics relatively easily, they need more credentials when engaging in activities that require a higher degree of involvement or knowledge. In such cases, it is insufficient to possess a fan base as a power source or some personal link with the subject as a token of legitimacy. As such, migrations are not without risk for celebrities, because it is often not clear to what extent the audience will tolerate them (Marshall, 1997: 107).*

In the almost 10 years since, where our society has witnessed a Donald Trump presidency, as well as the rise of social media influencers who have substantial followings and considerable celebrity status, it can be observed and is currently debated, whether or not celebrity migration, or the conversion of celebrity social status from one field to another, can be said to still have those same limits. What is “tolerated” or “tolerable” by the public is arguably far more divorced from credentials and knowledge, and more increasingly determined by tokens of legitimacy, something as easy as having a personal link with the subject matter. To some extent, it is possible that the achievement of celebrity status and fame in the case of no discernable talent—attributed celebrity—is now seen as a no different, or even more noteworthy than achieved celebrity. Or, as Kim Kardashian has tagged—*#NotBadForAGirlWithNoTalent*—after she appeared on the cover of *Forbes* magazine, a post which has garnered over 780,000 likes.

### The Art of Architecture

Even as the presence of design increases across the multiplying and proliferating channels of traditional and new media, the instances of celebrities in the artistic fields migrating to architecture has increased. While the discipline and profession remain grounded in a longstanding, codified process for professional education, training, licensure, and practice, the professional monopoly granted to architects to practice architecture is increasingly eroding. This erosion comes from several factors outside of the discipline’s control including antitrust legislation from 1971 and 1990, as well as varying state to state requirements for licensure, in which fourteen jurisdictions do not require an accredited professional degree. While both of these measures were initially instituted to encourage competitions and to stoke the health of the profession, in many respects, which is outside the purview of this paper, they have served to ambiguate the public’s understanding and valuation of architectural expertise. The phenomenon of celebrities migrating into the realm of activity which has been traditionally the domain of architects, further obviates the need for serious credentials or experience to practice design of architecture in the public’s eye. Thus, while it is still unimaginable for a celebrity to migrate into the realm of medicine or law based on interest alone (and without disciplinary study and credentialing) it is not that unusual in architecture. Instead of being the exception, the presence of celebrities in architecture is encouraged and celebrated.

One example of this phenomena appeared to me last year via an Instagram ad that popped into my feed. The announced the immediate occupancy of 75 Kenmare, a \$72-million condo project in New York City. Under the heading “The Art of Architecture,” I understood that the design vision was developed by Kravitz Design, along with architect Andre Kikoski and DHA Capital. The way the ad was written and presented, it was clear that the three entities were working together, but that Kravitz Design was the lead, featured designer in the mix.

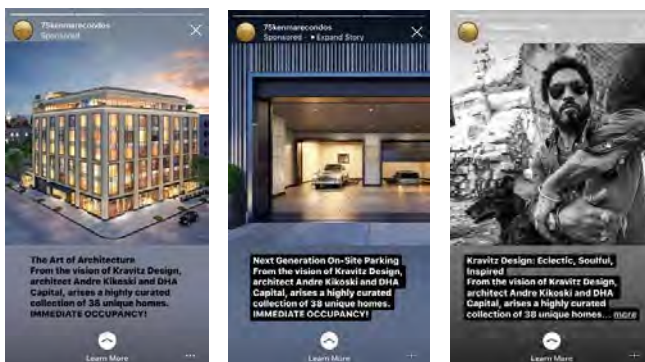


Fig. 7-9: Kravitz Design

According to Kravitz design:

*“75 Kenmare is a collection of 38 uniquely modern condominiums curated by Kravitz Design. Tasked with creating distinctive public and private interiors, Kravitz combined raw, highly tactile details with impeccably polished amenities to impart a sophisticated New York feel that merges uptown elegance with a downtown edge. This project is quintessential Kravitz Design in overall feel and execution.”*

Other clients of Kravitz Design include the Related Companies (\$50 billion in assets), Extell (\$223.4 million revenue), and SBE Entertainment Group (\$223.5 million revenue), all development companies with tremendous capital to develop and build projects throughout not only New York City, but several other urban areas around the United States. It was not until the third image swipe that I recognized Mr. Kravitz the designer: “*Kravitz Design, Inc. was founded by Renaissance man and legendary music icon Lenny Kravitz.*”

Recording artist Pharrell Williams, also recently entered architecture with a 750-unit housing complex in Toronto. About the development, which is named “Untitled,” Williams said, “I was excited because it’s architecture, another opportunity to learn something from people who are really talented, and to express myself in a different discipline.” Several articles covering the news of the project, describe Williams’s involvement a protagonist in the design process. Major news outlet Toronto.com led their story with the headline: *‘Happy’ singer Pharrell Williams designs ‘Untitled’ condo in Toronto.*

In both the aforementioned examples of celebrities migrating into the realm of architecture, what is worth noting is how any boundaries around the expertise of architecture as a distinct intellectual and professional enterprise seem to fall away. Also of note is that these “celebrity-designed” architectures are not one-offs. They are substantial projects that will continue to occupy a larger slice of architecture’s domain. The primary passport to entry, for both Williams and Kravitz, is their expression of an “intuitive sense of design.” This token of legitimacy not only reduces the importance of architectural expertise, it also reduces the public’s desire for such expertise. This swap is backed by multi-millions of dollars from real-estate developers and endorsements and absorbed by a billion followers and fans.



Fig. 10: Untitled, Exterior Rendering, Fig. 11: Ad

Instagram, a single social media platform, has an estimated 1.075 billion active users. It is the primary means by which those billion plus people engage with celebrities, but also is the forum by which people not familiar with architecture and design get their first exposure to our field. As social media and the internet continues to grow as the principal and majority means by which people receive visual information, the way in which celebrities (who have tremendously large followings) understand, engage, and portray architecture, is not a counterpoint to the discipline and profession of architecture; it is potentially its complete replacement.

## II. THE AMERICAN DREAM

In her speech at the Democratic National Convention in 2020, now Vice President Kamala Harris reminded the audience that “the cynical logic that says the American dream belongs to some of us...Well, I’ll tell you whom the American dream belongs to... The American dream belongs to all of us.”

How does one begin to define the American Dream? Whether a set of goals, a collection of ideas, evidence of American exceptionalism, freedom, success, a national motto, imaginary or real, scholarship suggests that the American Dream, first termed in 1931, is the product of the national, collective imagination to determine a structure and process for upward mobility (Samuel 2012, Jillson 2004, Cullen 2003). Now, ninety years since the term was introduced into popular culture by writer James Truslow Adams (Cullen 2003), one of its most visible manifestations lies with America’s widespread fascination with and desire for home ownership.

The first half of the twentieth century saw a new rallying cry: one where thinkers, politicians, businessmen, and architects came together behind mass home ownership as a moral ideal. (Kwak 2015). As with many mythologies, the dream of home ownership in America is part legend and part fact. (Kwak 2015, Cullen 2003, Hirt 2018). On the side of fact, the United States ranks forty-first in the world, with a 65.3 percent home ownership rate (2019 US



Census data), which is not anywhere near the highest rate globally, located in Romania at 96.4 percent. In spite of the contradiction between imagined and actual levels of home ownership (Kwak 2015), the symbol of home ownership remains integral to the very heart of Americanness, founded on the principal that anyone can attain success and create value through hard work.

Fueled by federal support in the form of the 1937 Housing Act, the Home Owner's Loan Corporation, and the 1934 creation of the FHA (Federal Housing Administration), among others, by the mid-twentieth century, the United States saw a significant rise in home ownership rates. According to historian Thomas J. Sugrue, "In 1930, only 30 percent of Americans owned their own homes; by 1960, more than 60 percent were home owners. Home ownership thus became an emblem of American citizenship," evidence that the American Dream of upward mobility for everyone was not imaginary, but that it was true (Cullen 2003, Goodman and Meyer 2018). William Levitt, founder of America's first post-war subdivision, declared that the American home owner could never be a Communist because "he has too much to do." Almost immediately, the concept of home ownership became tied to national pride and patriotism as a quintessential American ideal.

In his essay, "The Case for Reparations," Ta-Nehisi Coates (2014) emphasizes that this emblem of the American Dream was, "not to be awarded to blacks." Within the rhetoric of collective pride and striving for home ownership, the support structures put forth to help realize mass home ownership and the American Dream were, and continue to be, segregated and unequal. In promoting his own suggestions for Utopia, Kanye West inadvertently promotes an image of success and solution that is cover for persistent, centuries-old attitudes that are racist and exclusionary. In his earnest proposals to "make the world better" through social housing proposals, West relies on his good taste to substantiate a "beneficial" vision. Yet, his proposal is drenched in elitism and expense, as evidenced by the style and construction methods implied in the renderings, which exude a rarefied, out-of-reach sense of luxury, especially for the intended residents from the low and lowest income backgrounds.

The delivery of good architecture, especially at the housing level, remains deeply compromised in the wake of Neoliberalism and is further stymied by the public's access to sound architectural expertise. As governments such as those in the United States and Britain turned to greatly reduce economic management and government intervention, public attitudes increasingly deferred to a belief in the power of free markets. As Owen Hopkins writes, one consequence for architects and architecture is: "In the 1970s, most architects worked in the public sector, and most were involved in building (social) housing. Today, a tiny fraction of architects remain employed in the public sector, while almost all housing is built by and for the private sector, with many developments having little if any architect involvement." (Hopkins, 2018) When the majority of housing in the United States is now conceived and built around consumerist objectives and determinants, the desires of the public—their design desires, wants, and preferences—become primary in the determination of how and what new housing will be developed. When the primary source of these desires is generated by celebrities, untrained and without a professional education in architecture, the wider societal responsibilities that the built environment bears toward society, continue to be unfulfilled. The channels to address longstanding issues of income inequality or the delivery of good, sound architecture as basic human right are fragmented or non-existent.

It can be argued that the majority of American society has less exposure to, awareness of, or interest in architects than it does celebrities. Starting in 2008, new-student enrollment in architecture steadily declined, only to rebound by a few hundred students annually during the last five years. (Fewer than 7000 new students enrolled nationally in 2014.)<sup>1</sup> If we compare that to other learned professions such as law or medicine, where yearly enrollment is in the tens of thousands, the cumulative impact to the number of professionals in each discipline is staggering: in 2020 there are approximately 100,000 registered architects in the United States; 1.33 million licensed lawyers; and 1 million licensed physicians. It could be argued that our capacity to serve society through the built environment (architecture) is one-twelfth our capacity through social justice (law) or one-tenth of our capacity to serve its physical health (medicine). Conversely, the construction industry, with 7 million employees, has fourteen times the capacity as architecture to impact the built environment. This disparity strongly suggests that architecture's contribution to a just and healthy society is far diminished in comparison to other, more visible disciplines. This lack of visibility—or more precisely—dearth of visibility of architecture is compounded when we consider the channels by which design information is communicated today.

"It is central to the topic of celebrity which was established in the 18th century and whose anatomy gives rise to a major paradox: sought after as a key form of social prestige, celebrity is typically decried as superficial and ephemeral. Its emergence does not signal cultural decline or the rise of an increasingly plebiscitary public; rather, it is a characteristic trait of modern democratic societies, inextricably linked to the development of public opinion.

"With regard to celebrity, the public is conceived as an effect of collective imitation, whereby individuals are influenced at a distance by the knowledge that they are interested in the same things/people at the same moment." (Lilti 2019)

### III. SPATIAL NARCISSISM

The embrace of home ownership as a core symbol of the American Dream accelerated through the early twenty-first century, especially so prior to and leading up to the subprime mortgage crisis and Great Recession. Earlier changes in lending practices and rise of housing prices have given rise to the longstanding perception that mortgage debt is “good debt.” Historian Louis Hyman explains that through the 1970s, home values had risen every year since the Great Depression, making houses the “easiest way for people to leverage their equity—multiplying the reward on an increasing value of an asset,” and also giving the impression that buying a house was incredibly prudent. In this context, “Homes, for most Americans, were the only kind of financial leverage to which they could have access.” (Hyman 2012) As the primary and almost singular vehicle for wealth generation, home ownership has arguably transformed into an activity akin to a personal right or personal liberty to most Americans. Home equity is a means of not only generating, but also of controlling wealth for most Americans. As such, two rights afforded by home ownership—the right to change the asset at will and the right to sell for a profit—has led to a phenomenon I term “spatial narcissism.” Seen as assets that could grow in value, homes began to mushroom in size.

For nearly fifty years, the youngest baby boomers and Gen Xers had come to embrace a pumped-up form of home ownership in the first two decades of the new millennium: On average, the American home size swelled from Levittown’s 720 square feet to a 2019 national average of 2,322 square feet (US Census 2019). This bloating is not only physical. Ongoing in America since the postwar era, real estate has been a primary means to accumulate wealth (Sugrue 2008). In addition to financial wealth gained as an asset, the acquisition of a home also triggered the accrual of other types of capital such as prestige, a form of psycho-social capital, as well as a bundle of rights, which constitute a type of legal wealth (Marcuse 2020) that includes not only the right to occupy the property, but also the right to put up a fence (i.e., exclude others), the right to change the property (inside and outside), as well as the right to pass on to heirs, and the right to sell the home for profit. Real estate not only provided a comfortable place to live, but also (in most cases) gave home owners a huge opportunity for creating and securing wealth (Marcuse 2020). This thinking, which links maximizing profits through the act of “maxing out” a property (much like maxing-out a credit card), has given rise to a narcissistic, self-centered attitude toward home ownership. Take for example one episode of the HGTV show *Good Bones*, where host Mina Starsiak shares the realization of her “Forever Home” with audiences.



**Fig. 12:** Taj MaMina design sketch + **Fig. 13:** Taj MaMina streetview + **Fig. 14:** Opposite street view

Upon finalization of the initial plans for the ground-up building, Mina’s cohort, who is also her mother Karen, takes to calling the home the *Taj MaMina*, which according to the HGTV website, is due to “its grand scale and meticulous planning.” Moreover, the distortion and misfiring present in the *Taj MaMina*, is evident in the intention to bring the “Old South to Indianapolis’s Fountain Square district. ‘We wanted to bring in a southern feel,’ said Mina, “with big columns, large balconies, porch fans and black iron fencing.’” The final images of the house reveal that like in Kanye West’s proposal for low-income housing, the final built outcome of Mina’s aspirations is a complete distortion of the original architecture of the vernacular inspiration of the Charleston Single-House typology. Moreover, when viewed from the street, the effects of spatial narcissism can be seen in the disproportionate scale of Mina’s forever home when compared to the existing housing fabric. This forever home, once constructed and shared as model of success to HGTV’s viewership, now assumes a significant power to shape the desires and actions of millions of individual home owners. Swivel the Google streetview to directly opposite the *Taj MaMina*, and the manifestation of spatial narcissism becomes evident.

#### The Squatter

In season one of HGTV’s *Windy City Rehab*, Alison Victoria is in the backyard of a 1600 square foot detached house in the Wicker Park neighborhood of Chicago. For two seasons now, Alison and her partner Donovan have shared their “house flip” projects with audiences from the HGTV network, a cable channel dedicated to reality television programming on matters of home improvement and real estate. The success of HGTV programming and its hosts, most of which are self-made or self-taught “experts” in the building, construction, and decorating trades, has tapped into the celebrity-through-audience model. Because of the millions of viewers and fans of HGTV shows, the hosts rise to celebrity in their own right.

Cutting back to the screenshot from the beginning segments of the show, viewers watch Alison and Donovan debate the purchase of the Wicker Park property. The pair marvel at the size of the backyard, and banter about how they can expand the house’s footprint. The potential is undeniable, yet Alison sees some downsides to the purchase:



"I love everything I'm hearing," says Alison, "but the renter upstairs freaks me out. We can't get up there!"  
"He could stay there for months," Donovan replies.  
"And they have all the rights," Alison says. "It's a risk for us. A new risk that we haven't really run into. I've not done a project so big!"  
"This house is my dream build, with my biggest nightmare: a renter."  
In the end, the partners close on the house, and resolve to "take care of the issue with the current tenant."  
As the episode progresses, we hear other of Alison's priorities: "We're gonna do everything we can to find the tenant a new residence. In this neighborhood and at this price point, this has to be a single-family home."



Fig. 15-16: Discussing tenant + Fig. 17-18: Original property and expanded footprint

After four months, Alison and Donovan are finally able to negotiate a relocation for their upstairs renter.

Donovan: "I'm scared that we're entering into something that could spiral out of control."

Alison: "It's already kind of spiraled. You know, everything is just stopping this house—a squatter and now landmark."

Alison: "We're already down \$16,000 from the renter situation and relocating him. So now it's like we can't just be spending money, in other costs, you know?"

In less than 15 minutes of the show, Alison's remarks portray the nameless, faceless tenant as a sinister actor. He is entirely invisible, yet clearly embodies and personifies the longstanding prejudice and bias against most every type of housing that isn't the single-family detached house, as well as the societal bias we hold in celebration of the home owner and disdain of the renter.

In her work on housing tenure, Heather Rollwagan explains:

"Housing tenure—whether a home is owned or rented by its occupant—is as much a social experience as a financial one. In nations dominated by home ownership, renting is a marginalized form of housing tenure and therefore considered far less desirable. Housing scholars have tied tenure prejudice to issues of race and class, as rental housing is disproportionately occupied by low-income earners and racialized minorities. One dimension of tenure prejudice concerns perceptions of crime. Research suggests that affordable housing projects are perceived to bring higher levels of crime and violence to the neighbourhood. These perceptions exist in the face of research suggesting that there is little effect of public housing on the actual rate of crime in a neighbourhood." - Rollwagan 2015, p. 2

The scope of programming by networks such as HGTV and its hosts completely out shadow any platform or channel that connects architectural expertise to the public. Through the reality genre, programs like *Property Brothers* or *Good Bones*, along with their hosts (twin brothers Jonathan and Drew and mother-daughter team Mina and Karen) have millions of weekly viewers, elevating HGTV to be the fourth-highest-rated cable network in the United States. HGTV mints its own types of celebrity: one boosted by another facet of the American Dream myth, that of the bootstrapping, self-made success. This belief and faith of the self-made success also ties another component of spatial narcissism which is the distinctly American intertwining of individualism, democracy, and capitalism.

The negative impact of spatial narcissism is amplified through the institution of mass home ownership in the United States, and the prolonged dissemination of non-expert opinions. The consequence for cities and towns across the United States is the continued, fervent protection of residential land for single-family homes, even in the face of a serious housing affordability crisis. Spatial values, like the ones embraced by Alison Victoria and Mina Starsiak, are embraced by millions of viewers, week after week, reinforcing the sacrifice of the built environment that we share. In its place, as hundreds of millions of Americans watch, consume, and accept a new set of conventions and practices for the built environment, ones that bias individual expression, individual profit, and individual priorities, we collectively move further away from a shared ideal of a healthy built environment and continue to bolster unequal, inequitable, exclusionary institutions like single-family-only residential areas or elite and distorted ideals of architectural design.

## CONCLUSION

Because housing is arguably the most proximate, ubiquitous building type that Americans encounter on a daily basis, the single-family house's position, as a primary emblem of the American Dream and mythology of *how Americans live* and of *how Americans succeed*, the effect of celebrity opinion as expertise, amplified through the massive reach and constancy of social media, cannot be discounted as harmless entertainment. What celebrities tout deeply matters to how we are able to shape the future of our society, not only through politics, but especially through our built environment, where the values of our society become solid. The pursuit of the good life, status and wealth through home ownership is a core, defining principle of the American Dream and a driving force behind a national endorsement and enactment of spatial narcissism. Yet embedded in the rhetoric of democratic access to wealth and the celebration of the "self-made" success stories, the American Dream remains inequitable and inaccessible; home ownership continues to benefit only a select segment of our population; and we continue to lose the battle to shape a healthy built environment that we all share.

# Climate Change and Design: Multiscalar Design Research in the Sonoran Desert

Susannah Dickinson<sup>1</sup>, Aletheia Ida<sup>1</sup>

<sup>1</sup>University of Arizona, Tucson, AZ

**ABSTRACT:** The climate change emergency requires that we drastically re-evaluate the design of the built environment and our pedagogical methods and tools. This essay looks at this issue directly through a methodology that was implemented in an upper-level architecture design studio course as an initial testbed. At its core, the methodological framework insists upon interscalar observation and analysis across natural biomes, the built environment, and sociocultural conditions. The framework is established to address and reconsider our approach to design of the built environment through careful study of regional sociocultural and natural system dynamics. The architectural design process is informed by intense research beginning with contemporary theory readings, digital design methods, and regional field work. Our research questions pertain to how we might advance the design process and outcomes through these specific layers of climate change and dynamic system considerations. The theories, tools, and methods are posed to enable responsive and adaptive design outcomes. In particular, this essay explores the interscalar context for grounded research and climate change impacts within the Sonoran Desert region of Arizona, USA and Sonora, Mexico. The transborder region was selected to highlight the challenging political context, migration paths (for humans and others), ecological flows, and various humanitarian crises.

Examples of student projects demonstrate the interrelationships between natural and human, biotic and abiotic, boundary and expansion, micro and macro, and past and future that might be realized through this multiscalar design research process. The significant outcomes convey that our potential built environment interventions emphasize the infrastructural, demonstrational, educational, experiential, and interactive modalities of physical constructs - each requiring multidisciplinary expertise to inform a necessary socio-cultural shift towards climate change remediation and adaptation.

**KEYWORDS:** Design pedagogy, digital design, field research, sustainability, interscalar design

## 1.0 INTRODUCTION

Earth's climate is now changing faster than at any point in the history of modern civilization, primarily as a result of human activities. (USGCRP 2018, 1)

Contemporary dynamics of technology and societies are greatly influencing the shape of built environments, which reciprocally affect the change and adaptation of natural environments. In part, the anthropogenic forces that are largely impacting climate change have perpetuated environmental dilemmas and natural disasters. Globally, many geographic contexts and locations are experiencing unprecedented impacts from climate change, such as increased drought, hurricanes and heavy storms, flooding, forest fires, and related acute shifts and general trends of increasing temperatures. While we are beginning to understand some of the physical and technological infrastructure and socio-cultural patterns that have led to climate change conditions, we are not yet clear on how the design of our built environment might first take cues from nature and evolve in a modality that is also adaptable to, and compatible with, natural systems at multiple scales.

Our essay explores the interscalar context for grounded research and climate change impacts within the Sonoran Desert region of Arizona, USA and Sonora, Mexico. This robust natural biome of an extreme hot-arid climate that is coupled with sky-islands of pinyon-pine forests, canyons, and water bodies along the Gulf of California Coast is a complex ecosystem. Climate change dynamics and challenges are due to the primary land mass being surrounded by sea-level rise with concurrent desert and forest drought as well as severe monsoons and tropical storms (K. C., P. et al. 2017). Long-term drought in regional forests makes these ecosystems more susceptible to prolific forest fires (Savage, M. et al. 2013; Robles, M.D. et al. 2014). Temperature increase impacts the heat stress experienced by animal and human populations, affecting both natural and built ecologies in unforeseen ways (Beaumont, L. J et al. 2011). Because of the challenging political context at the border of Mexico and the United States and the presence of a physical boundary, migration paths, ecological flows, and humanitarian crises are further exacerbated.

To address the complexities of the societal and environmental challenges through design, the proposed methodology integrates knowledge of climate and complexity theories with advanced digital technologies from different disciplines to provide emergent potentials for our future.

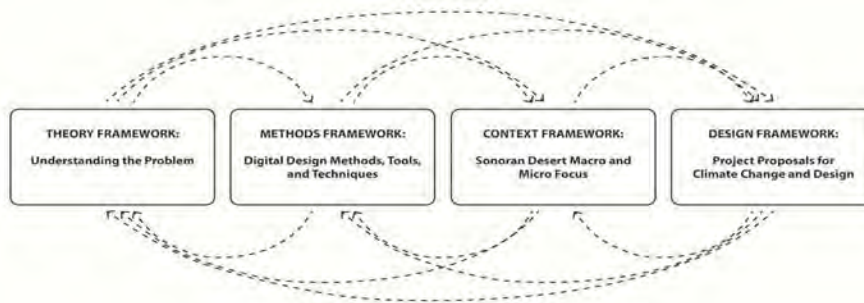
If the climate is not part of the early design phase, it will not influence dominant factors such as form and typology and will require subsequent technical means in or on the building to compensate. (Hönger et al. 2013, 9)

Furthermore, the theoretical and phenomenological knowledge of the environment are also considered through their relationship to the arts and humanities. Parallel modes for integrating accessible micro-sensing and field data collection technologies with digital design methods will enable 'expanding ecologies' by allowing for new layers of information to intersect where previously hidden. For example, conducting real-time sample testing of local waters, in conjunction with GIS mapping of large-scale regional ground-water levels, begin to describe zones of chemical contaminations and imbalances that correlate with transborder flows. In this sense, the emergent design process across micro and macro contexts of physical and cultural information culminate in design proposals that simultaneously educate and mitigate current unprecedented climate change impacts. Using the lens of both a microbiologist and of a geologist, as well as a climatologist and humanitarian, the exercises required throughout the design process force transdisciplinary territories to converge with the knowledge of the designer.

## 2.0 EDUCATIONAL CONTEXT AND METHODOLOGY

The methodology described through this essay (Fig. 1) establishes a sequence of frameworks, including: 1) understanding the problem (theory framework – two weeks); 2) digital design methods, tools, and techniques (methods framework – two weeks); 3) Sonoran Desert macro and micro focus (regional context framework – four weeks); and 4) design project proposals (design framework – eight weeks). The studio pedagogy taps into the technical expertise and professional and academic design backgrounds of the authors with their knowledge of digital methodologies, environmental sciences, climate and complexity theory, while also connecting dynamic, scientific technical tools with theoretical and phenomenological knowledge of the environment and its relationship to the arts, design and humanities.

The pedagogy was executed in an upper level design studio in a state university, land-grant institution<sup>1</sup> for undergraduate and graduate architecture students in accredited programs as well as research-based post-graduate master's students from international backgrounds. The typical studio sequence meets three afternoons per week for four-hours each day and constitutes a six-credit course over a 16-week semester. The studio course, titled Climate Change and Design was the first in the college to look at this issue directly, with the goal of becoming a testbed to ultimately refocus many other courses in our curriculum. The class engaged 20 students in the exploration and research of real world impacts and changes to the Sonoran Desert region of Arizona, USA and Sonora, Mexico, culminating in design proposals to educate and mitigate this unprecedented change. The design pedagogy was influenced by the process of thinking and doing (innovation) versus the more traditional architectural studio brief of problem-solving, where students are typically handed a site and program and work within these given constraints. This more emergent, design as research based trans-critical<sup>2</sup>, studio pedagogy makes the students more active participants in the learning process and reflects the dynamic nature of knowledge and life. Design thinking (theory) and doing (practice) are non-linear, so production and reflection are an imperative part of the process. Requiring students to pursue multiscalar inquiry with the macro-scale data mapping and subsequently forcing a close look at micro-scale field conditions is a clear example of engaging the thinking (analyzing correlational spatio-temporal data) and doing (experiencing, measuring, and documenting the micro-environment).



**Figure 1:** Studio course methodology, Climate Change and Design: (Ida and Dickinson, 2020)

### 2.1 Understanding the Problem

Initial reading and research methodologies related to climate and comfort, abiotic systems, boundaries, architecture of change and complexity with additional texts based on the Anthropocene, posthumanism, and new materialist philosophies.

It is through new materialism, I would claim, that we can open up an inquiry into the nonlinear logic and morphogenetic tendencies in matter and into the capacity of matter to self-organize and play an active role in its own formation. Moreover, we can learn lessons from the behavior of matter and use them to help us to understand the formation of larger-scale agglomerations, such as cities, continents, and indeed entire planets. (Leach 2017, 18)

The course investigations began with assigned texts, a literature review and awareness of current events from reputable media sources. Texts were kept short and focused where possible, so as not to overwhelm the architecture students, who come to the class with differing abilities and backgrounds. Most architecture students and professionals are generalists, without much depth of knowledge in theory, science, and the humanities. It is this generalist or hybrid approach though, i.e. combining the arts, humanities, and sciences, which is the real strength of the architecture profession and academy, especially in our complex times, so it needs to be reinforced more pedagogically. We need to embrace scientific advances, yet not be reductive to science in the process, so the connection to philosophy and other fields is key.

In the Anthropocene age, where human actions have become the most influential factor in the environment, such an approach to hybridity offers the best chances to negotiate dramatic transformations in our environment. (Hight 2014, 100)

It is important to value texts in their own right and give students some edited direction to the issues. These selected texts should also be evaluated from various disciplines together, as a way of introducing students to the connections between the humanities, philosophy, science, and design. It is imperative that this 'getting up to speed' with the problem includes key contemporary thinkers and practitioners who are on the cutting edge to give the students a chance at relevancy. Some knowledge of complexity and network science is also important as it can help students understand the interrelated phenomena around them, like weather and climate, and make connections to that across multiple fields and topics.

Four subject areas are fundamental to the study of complex systems: information, computation, dynamics and chaos, and evolution [...] life and evolution can be mimicked in computers, and conversely how the notion of computation itself is being imported to explain the behavior of natural systems. (Mitchell 2009, xiii)

In the process of surveying texts and media content, students conducted mapping exercises to develop an interscalar and interdisciplinary framework of regional climate issues and relationships. The meta-conditions of the maps relied on philosophical and theoretical stances posited by the students based on their understanding and interpretations of the assigned readings (Fig. 2). The maps ultimately provide a research framework (ontology) and a field of inquiry (epistemology) for students to pursue through the subsequent exercises and investigations (i.e. digital design methods and field observations). As design students are often visual in nature, it is paramount to integrate each stage of the pedagogical process with diagrams and some kind of representation or making, to enforce the learning objectives (i.e. instead of just discussing texts in a seminar style setting).



**Figure 2:** Example student work, diagramming inter-relationships of theories and issues (left), and boundary concepts (right): (Anahita Modrek, 2020)

The overarching theory-mapping exercise enabled students to engage with theories of design and research from both a meta-theory and grounded-theory approach, simultaneously. It also became an opportunity to begin a discussion on the subject of design as research and the representation challenges of dynamic and interconnected relationships.

From the beginning representation has been intrinsic to architecture. Knowledge can be produced by 'seeing' with different eyes, not just by talking or writing [...] but rather by discovering the always mutating conditions of natural systems themselves that transcend the boundaries of our own discipline. (Agrest 2018, 9)

## 2.2 Digital Design Methods

The second mapping exercise incorporates both the literal geography and physical context of the region as well as additional GIS data for socio-economic context. Global climatology time-lapse imaging from NASA Earth Observatory in conjunction with regional imaging databases were utilized to establish temporal change phenomena. Students made calculated assumptions based on historical climate-change data and future projections in order to inform the algorithms for agent-based modeling and cellular automata response mechanisms.

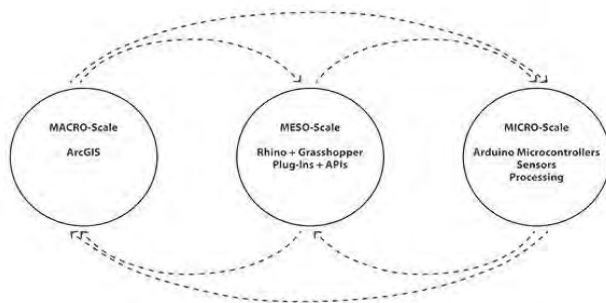
In general, we are engaging with digital modes of organizing and utilizing data and information to process, analyze, and characterize the complex, dynamic conditions of our natural and built environments. The work addresses how these different tools can interconnect and link different scales and sets of data and information into a common platform for visualization, critical analysis, and design development. Specific workshops and skill-building sessions are introduced, but as developments in digital tools and techniques are continually evolving, it is important to leave time and space for students to engage with emergent design processes and heuristic modes of discovery. The pedagogical goal was not to promote any kind of geographical or scientific determinism, but to start uncovering the complexities of data, information, relationships and flows.

Emergence is of momentous importance to architecture, demanding substantial revisions to the way in which we produce designs [...] we are within the horizon of a systemic change, from the design and production of individual 'signature' buildings to an ecology in which evolutionary designs have sufficient intelligence to adapt and communicate, and from which intelligent cities will emerge. (Weinstock 2004, 16)

ArcGIS is the primary tool for collecting and mapping macro-scale information and has its origins in the methodology of mapping with layers of information as established by Ian McHarg's natural system analyses (McHarg 1992). Seeing the built environment more akin to a landscape, in a way that McHarg and James Corner have pioneered helps students also gain an understanding of a sense of time. This is important as it helps students realize that architecture's impacts and relationships do not end at the site boundary at a specific moment in time and it also reinforces the concept of environmental interconnectivity in time and (interscalar) space. Most typical GIS data used at the urban scale are generally two-dimensional, static data. As we are looking at dynamic systems, part of the digital technology research involved is the interface between plug-ins and programs to make as much of our data as live and linked as possible to enable more sophisticated simulations. It is also imperative for students to remain creative and critical in their selection of data and sources and to include qualitative and quantitative information.

Culture and climate cannot be separated. Our perception and comfort demands are decisively shaped by the climatic conditions we live in. So an integral, simultaneous grasp of culture, lifestyle, climate and architecture must supplement the technical simulation. (Hönger et al. 2013, 83)

The digital design platform used as a centralizing interface is Rhino-Grasshopper with associated plug-ins and Application Program Interfaces (APIs) that allow us to demonstrate with students how customization and coding can provide both agency and discovery to the designer in the analysis and development process. These platforms provide the meso-scale connection between ArcGIS information and Arduino-Processing information. There are also several Grasshopper plug-ins available which enable GIS and Arduino data to be leveraged into a Rhino model. For micro-scale integration, Arduino and Processing platforms establish a basic understanding of microcontroller sensing data collection and visualization techniques (Fig. 3).

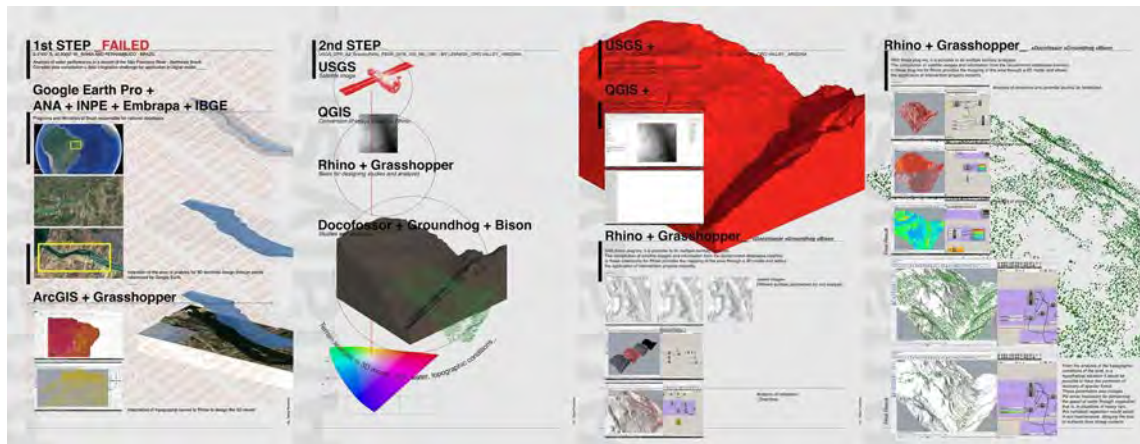


**Figure 3:** Digital tools, techniques and methods for interscalar design processes: (Ida and Dickinson, 2020)

Furthermore, students were encouraged to explore unconventional uses of the tools and platforms presented in the studio and to disseminate to the group additional relevant tools and methodologies that they found. The question of 'boundary condition' was posed at all scales based on established literature for boundary layer climates (Oke 1987), building energy analysis (Srinivasan and Moe 2015), and dissipative micro-structures (Prigogine 1980). We seek exploratory questions of how such atypical scalar relations and contents might be discoverable through the use of these digital tools and techniques in new ways (Fig. 4).

While all students entered into the studio with different skill-sets, there was a normalized awareness of the range of tools for interscalar design processes by the end of the semester. Based on entry surveys, we identified that the majority of students were familiar or proficient with the Rhino software platform but only three to four students were aware or familiar with Processing or Arduino microcontrollers and sensing devices. In addition, only half of the students identified awareness or basic understanding of ArcGIS and with Grasshopper and related plug-ins. In all cases, by the end of the semester, the students gained new skills and proficiencies with these various tools as demonstrated by the resulting project deliverables.





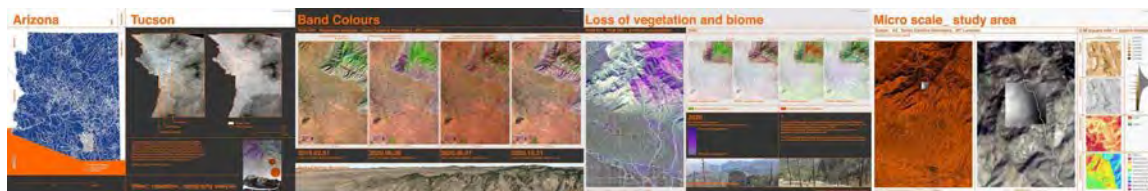
**Figure 4:** Example student digital mapping exploration of various methods using GIS and Satellite Imagery: (Felipe Florentino, 2020)

### 2.3 Sonoran Desert Macro and Micro Focus

The Sonoran Desert region holistically offers a unique opportunity to learn about and understand interscalar relationships between climate impacts and a broad range of natural biomes alongside diverse political, historical, and cultural contexts. The robust natural ecosystem of the Sonoran Desert is characterized as an extreme hot-arid climate, but is a desert that also contains sky-islands, pinyon-pine forests, canyons, and water bodies along the Gulf of California Coast (Phillips and Wentworth Comus 2018). Prevalent industries such as copper mining and pecan farm agriculture in southern Arizona have historically contributed to regional environmental challenges, especially with water resources. Temperature increase from climate change also impacts animal and human populations, affecting both natural and built ecologies in unforeseen ways. In particular, both the asylum seekers and undocumented border crossers are subject to additional health challenges under climate change conditions (thermal and water stress variables). The decisions our society makes for the planning and design of physical infrastructure, such as border walls, also perpetuate climate change by impacting natural ecological systems in adverse ways – i.e. animal migration paths, water resource flows, etc. (Rael 2017).

At this time an introduction of Geoffrey West's book, "Scale, The Universal Laws of Growth, Innovation, Sustainability, and the Pace of Life in Organisms, Cities, Economies, and Companies," helps students to explore the power laws and fractal and network geometrical relationships between the macro and micro fabric (Fig. 5).

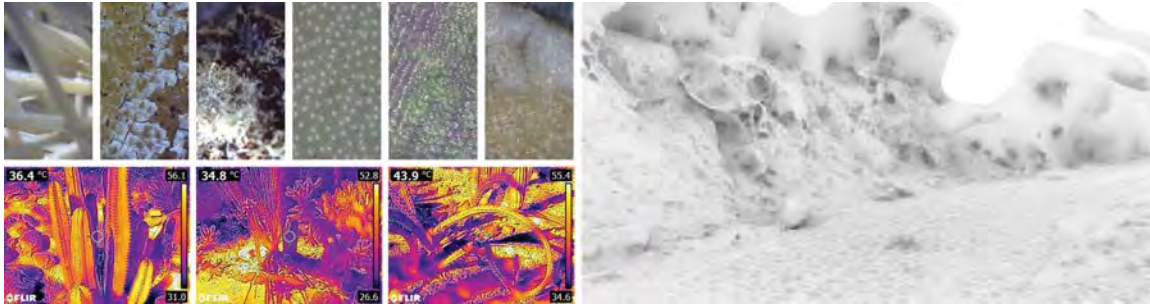
There is a common conceptual framework underlying all these complex phenomena and that the dynamics, growth, and organization of animals, plants, human social behavior, cities, and companies are, in fact, subject to similar generic 'laws.' (West 2017, 5)



**Figure 5:** Example student work showing macro and micro focus areas: (Felipe Florentino, 2020)

Field visits around the immediate region were more limited than planned due to COVID-19, but were crucial to expand notions of migration patterns and flows (human and non-human) that defy political boundaries and supplement prior mapping exercises. Field observations, integrated with on-site micro-sensing and data collection with microcontroller hardware, connected students directly to the natural materials and ecology of the region. Parallel videography and time-lapse photography provided observational phenomena for correlation to environmental data collection. Photography techniques were accomplished with different types of cameras: thermography for temperature imaging, micro-photography for material-scale imaging, and drone photography for aerial imaging, which were post-processed via various digital techniques, e.g. photogrammetry (Fig. 6). Using the digital mapping exercise as a foundation for the physical and invisible conditions of the region, students began to overlay and adapt their maps with empirical evidence and adjustments for real conditions vs. prior assumptions.





**Figure 6:** Example student field imaging: left upper; micro-photography, left lower; thermography, right; photogrammetry: (Ashwaq Jundus (top left), Wen Xie (bottom left), Logan Matos (right), 2020)

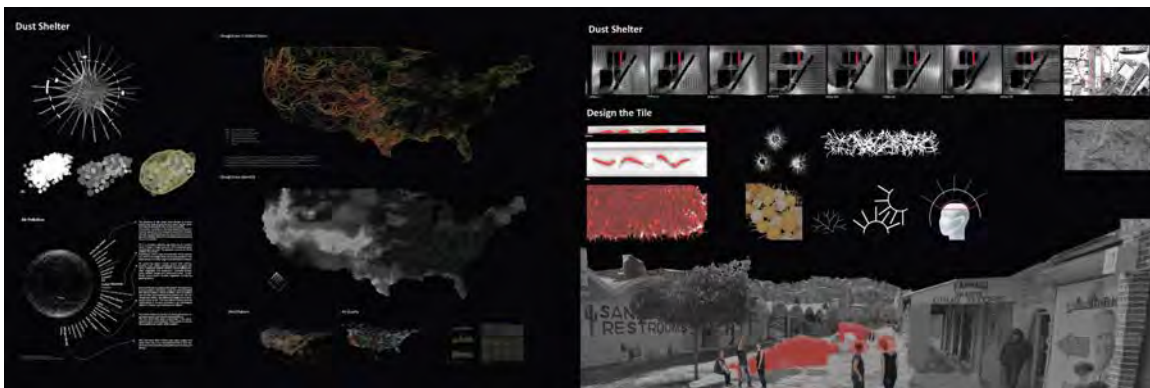
### 3.0 DESIGN PROJECT PROPOSALS

The expectations for the studio course included design proposals as emergent manifestations and outcomes of the evidence and information revealed from the prior exercises and studies. The projects resulted in an interscalar framework for design within the Sonoran Desert region or favored a particular scale (regional, urban, building, human, material, etc.). The regional context provides the content for students to engage with the methods, while the tools being used provide a new lens for analyzing and understanding the context.

We maintain that if climate is the problem, it could also be the tool for rethinking the urbanization of the planet and the city in a more ecological and sustainable way, providing a new quality of life that is more comfortable and more attuned to the senses. (Rahm 2014, 173)

Students were expected to radically address a multiplicity of conditions for change of built environment design and compatibility with natural systems through a range of micro to macro interventions. The successful proposals demonstrated the potential for both a shift in scientific approaches as well as phenomenological outcomes.

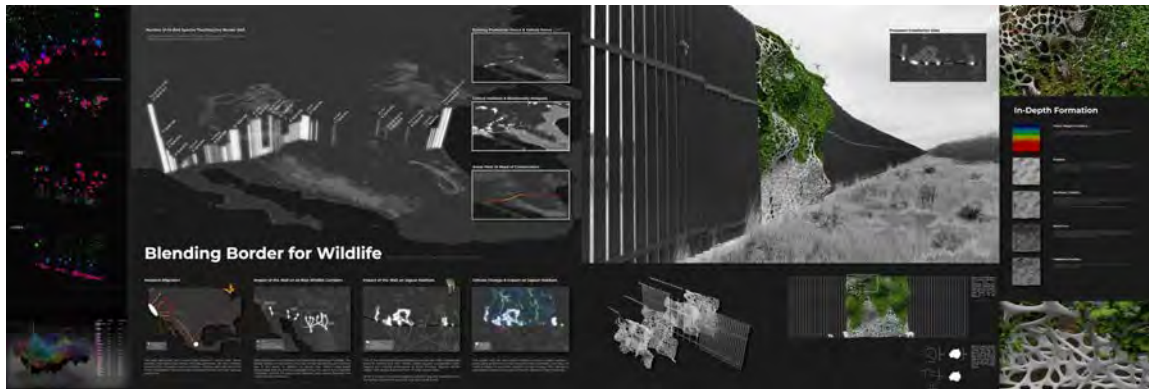
Inspirations from prior climate change studio projects (Hardy 2008) and precedent examples from designers working at different scales and different types of interventions provided encouragement towards the potential outcomes. Microbiological and bio-metabolism approaches to design include innovative in situ construction techniques with biological matter serving as the building block mechanisms. Examples include the work of Rachel Armstrong around the Venice wood-pile foundation bio-remediation strategy and studies by others for polylactic-acid biodegradable formwork. Human scale provocations suggest that smart fashion, body armatures, and bio-responsive material systems might allow for localized adaptation to environmental and cultural situations, especially when related to air-quality adaptation and dust storm responses (Fig. 7).



**Figure 7:** Extreme Sonoran climate and environment inform unique building technology potentials: dynamic data mapping (left), CFD analysis (top right), and human scale proposal for air-quality adaptation and dust storm emergency response (right): (Anahita Modrek, 2020)

Building-scale systems and technologies that integrate actuated materials and dynamic modulations (Kolarevic and Parlac 2018) alongside alternate spatial configurations lend insight to how our buildings might become adaptive in ways that are distinct from mechanisms of transformation in nature. Examples of urban-scale interventions suggest that the physical organizational schemes and infrastructure technologies for future cities will be drastically reimaged as a result of climate change impacts on sociocultural, epidemiological, and economic conditions. Expanding outwards, the regional design scenarios for climate change pose emphasis on new pattern languages and ingredients for modes of

adaptation across physical and sociocultural translations within natural ecosystems. These interscalar design proposals ultimately have a huge influence towards global impact and potential (Fig. 8).



**Figure 8:** Multiscalar design proposal for climate change and adaptation: transborder wildlife migration (left) and adaptive natural infrastructure (right): (Eugene Lee, 2020)

#### 4.0 CONCLUSION

The studio course was established through the articulated foundations of pedagogical structure<sup>3</sup> and series of framework mapping exercises. The core contents for the course were presented in a way that holistically engages theory and global discourse, emerging interscalar design methods, and a specific regional context for the application of design ideas and processes. While situating the topical issue around climate change, there is an allowance for the expansive nature of relational contents. We envision that the studio projects will be disseminated regionally with a local exhibit of work and more broadly through scholarship and publication. The methodology established in this design studio will be translatable to any location or climate type. While the Sonoran Desert provides an intense context for the layered mechanisms of natural and built environment relationships, it is only one of thousands worldwide.

The measures for success and evaluation criteria for the resulting student work and design proposals helped guide the understanding and value of different outcomes. The primary criteria of evaluation include the following: 1) critical theory outcomes – innovations on literature review; 2) skill development – adeptness with digital design tools and techniques; 3) relational contents' connections – level of considerations for regional and interdisciplinary multiplicity; 4) natural biome analysis – hierarchy of understanding regional natural systems as a platform for regional design; and 5) interscalar complexity – agility for design connections across scales and boundaries.

The expectations for student growth span across skill development and critical thinking. A large effort of this studio pedagogy is set to engage students with opening their ideas beyond what is known and allowing for new pathways of mind-mapping and transdisciplinary connections to be made. The basis of new modalities for 'design-thinking' resides in the ability for intellectual fortuity and nascent thought exploration as inspired by anthropologist Gregory Bateson (2000) who established the concept of an 'ecology of mind'. A major emphasis in Bateson's philosophy is that our focus in contemporary thinking should be placed on the relations between things rather than on the things themselves. By engaging future designers with methods and processes of both the interscalar and interdisciplinary relationships of our world, our resulting work and solutions may be more resilient and adaptive to ongoing fluctuations of dynamic change. It is the 'in-between' states, the conditions that exist at the intersections of boundaries, that will allow us to better co-exist with simultaneous contradictions and complexities.

#### ACKNOWLEDGEMENTS

We would like to thank the College of Architecture, Landscape Architecture and Planning at the University of Arizona for providing an in-house Grassroots Teaching Innovation Grant, which helped fund guest lectures, field tools, and regional travel. In addition, we are grateful to numerous colleagues and peers who provided guest lectures, workshops, and studio reviews, with particular thanks to: Kiel Moe, Kathy Velikov, Ronald Rael, Chris Lasch, Diane Austin, David Taylor, and Shujuan Li.

## REFERENCES

- Agrest, D. 2018. *Architecture of Nature – Nature of Architecture*. New York: Applied Research and Design Publishing.
- Bateson, G. 2000. *Steps to an Ecology of Mind*. Chicago: University of Chicago Press.
- Beaumont, L. J et al., 2011. Impacts of climate change on the world's most exceptional ecoregions. *Proceedings of the National Academy of Sciences - PNAS*, 108(6), pp.2306–2311.
- Congress of the United States of America. 1862. *Morrill Act*. [Online] Available at: [www.ourdocuments.gov/doc.php?flash=false&doc=33](http://www.ourdocuments.gov/doc.php?flash=false&doc=33) [Accessed 28 April 2020].
- Hardy, S. (ed.) 2008. *Environmental Tectonics – Forming Climatic Change*. London: AA Publications.
- Hight, C. 2014. "Designing Ecologies" in Reed, C. and Lister, N.-M. (eds.) *Projective Ecologies*. New York: Actar and Harvard University GSD, pp. 84-105.
- Hönger, C. et al. 2013. *Climate as a Design Factor – Architecture and Energy*. Lucerne: Quart Publishers.
- K. C., P. et al., 2017. *Effect of Climate Conditions on Land Surface Productivity Across the Mojave, Sonoran, and Chihuahuah Deserts and Apache Highlands*. Web.
- Kolarevic, B. and Parlac, V. (eds.) 2015. *Building Dynamics – Exploring Architecture of Change*: London: Routledge.
- Leach, N. 2017. "Matter Matters, A Philosophical Preface" Tibbits, S. (ed.) *Active Matter*. Cambridge: The MIT Press, pp. 18-24.
- McHarg, I. L. 1992. *Design With Nature*. Hoboken, NJ: John Wiley & Sons, Inc.
- Mitchell, M. 2009. *Complexity – A Guided Tour*. Oxford: Oxford University Press.
- Oke, T. R. 1987. *Boundary Layer Climates*, 2nd edition: New York: Routledge.
- Phillips, S. J. and Wentworth Comus, P. 2015. *A Natural History of the Sonoran Desert*: Oakland: University of California Press.
- Prigogine, I. 1980. *From Being to Becoming – Time and Complexity in the Physical Sciences*. New York: W. H. Freeman.
- Rael, R. 2017. *Borderwall as Architecture – A Manifesto for the U.S.-Mexico Boundary*. Oakland: University of California Press.
- Rahm, P. 2014. "Toward a Thermodynamic Urban Design" in *New Geographies | Grounding Metabolism, vol. 06*, pp. 166-173.
- Robles, M.D. et al., 2014. "Effects of Climate Variability and Accelerated Forest Thinning on Watershed-Scale Runoff in Southwestern USA Ponderosa Pine Forests: in *PLoS one*, 9(10), p.e111092.
- Salama, A. 2015. *Spatial Design Education: New Directions for Pedagogy in Architecture and Beyond*. Farnham, UK: Ashgate Publishing, Ltd,
- Savage, M.M., Nystrom, J. & Feddema, J. 2013. "Double whammy: high-severity fire and drought in ponderosa pine forests of the Southwest" in *Canadian journal of forest research*, 43(6), pp.570–583.
- Srinivasan, R. and Moe, K. 2015. *The Hierarchy of Energy in Architecture – Emergy Analysis*: New York: Routledge.
- USGCRP – United States Global Change Research Program. 2018. *Fourth National Climate Assessment – Volume II – Impacts, Risks, and Adaptation in the United States*. [Online] Available at: [nca2018.globalchange.gov/downloads/NCA4\\_2018\\_FullReport.pdf](http://nca2018.globalchange.gov/downloads/NCA4_2018_FullReport.pdf) [Accessed 28 April 2020].
- Weinstock, M. 2004. "Morphogenesis and the Mathematics of Emergence" in *AD | Emergence – Morphogenetic Design Strategies*, vol. 74, issue 3, pp. 10-17.
- West, G. 2017. *Scale – The Universal Laws of Life, Growth and Death in Organisms, Cities and Companies*: New York: Penguin Books.

## ENDNOTES

<sup>1</sup>The University of Arizona was established as a land-grant university in accordance with the Morrill Act of 1862, which endowed federally controlled land to the state for the use of higher education in order to emphasize teaching of practical arts (agriculture, mechanics, etc.). (Congress of the United States of America, 1862)

<sup>2</sup> Ashraf M. Salama has argued that this direction in pedagogy is needed today in part to be a more adaptable, evidence-based design studio and he encourages a less hierarchical relationship between educators and students, where both learn, ideally in trans-disciplinary contexts.

<sup>3</sup>At the time this studio course was developed, the COVID-19 outbreak and global pandemic occurred, resulting in shifting implications for built environment design (i.e. spatial, material, and technological reformations) and pedagogy (i.e. remote learning formats).

# Measuring the Impact of Environmental Quality on Elderly Residents' Cognitive Functioning – A Critical Review

Nasrin Golshany<sup>1</sup>, Ihab Elzeyadi<sup>1</sup>

<sup>1</sup>University of Oregon, Eugene, OR

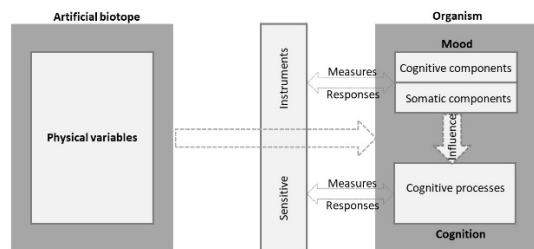
**ABSTRACT:** Cognitive impairment is a critical issue among the aging population. For elderly population it includes diseases, such as Dementia, Alzheimer, stress, and anxiety that are growing up dramatically worldwide in recent years. Previous studies reported that different attributes of the physical environment could affect participant's mood and affect cognitive performance. Currently, variety of cognitive tests are used to assess an occupant's response to changes in their physical environments. These cognitive tests are frequently used in environmental psychology and gerontology studies, however, their sensitivity to measuring impacts of the physical environment is still unverified. To address this problem, this study develops content analysis of the different cognitive tests through a critical review to determine which tests are more sensitive to measure the impact of the physical environment and spatial parameters on cognitive performance. This study utilized a systematic procedure of extensive keyword search and cross-search using combinations of keywords through the EBSCO research database. In addition, a supplemental search through Google Scholar and other architectural science related journals was conducted by analyzing studies investigating the impact of the physical environment on cognitive functioning. Next, we employed a systematic procedure of keyword search and cross-tabs, using combinations of keywords through multiple databases, in the field of psychology to find the most used cognitive tests employed in previous studies and then we conducted a comparative analysis between test parameters to evaluate their sensitivity to the physical environment parameters. The analysis revealed that Mini Mental State Examination (MMSE) is the most widely used cognitive test in previous studies. Results of this analysis indicate that the physical environment mainly influences cognitive functioning tests which involve visuospatial and constructional praxis cognitive domains such as Montreal Cognitive Assessment (MOCA) and Trail Making Test (TMT).

**KEYWORDS:** cognitive functioning, cognitive tests, physical environment, sensitivity, architecture

## 1.0 PHYSICAL ENVIRONMENTAL IMPACT ON COGNITIVE FUNCTION

The architecture of elderly environments is regarded as therapeutic modality to promote well-being and functionality for elderly residents. Knez, I. (1995) argues that different attributes of the natural and artificial environment (biotope) may induce different moods in people and cognitive processes also can be affected by these changes (see figure 1). Cognitive functioning defines performance in different tasks that need conscious mental effort (Lamportal.,2014). These tasks consist of memory (verbal, spatial, and working), attention, and executive function (Lezak, 2004).

In this study cognitive functioning refers to multiple mental abilities, including learning, thinking, reasoning, remembering, problem solving, decision making, and active working memory as the aging population shows a greater impairment in this area in comparison to other populations



**Figure 1:** Relationship between physical environment and cognitive and mood (after Knez, I. ,1995).

There is conclusive evidence that the physical environment of elderly settings can influence social interactions and promote active lifestyles (Kelly et al., 2014). In addition, the physical environment can affect cognition directly through cognitive and sensory stimulation and indirectly, through lifestyle changes (Engineeret al., 2004; Kempermann, 2008). Different studies show bright light therapy can improve cognitive functions (Fontana Gasio, P., 2003; Satlin, A., et al, 1992; Yamadera, et al, 2000; Graf, A., et al., 2001). Environmental condition and air quality impact on cognitive performance have also been measured through many studies (Sun, R., & Gu, D, 2008). Taylor, L., (2016) indicated different thermal conditions can impact positively and negatively cognitive performance. Further studies reveal a positive relationship between acoustic and visual conditions on task performance and cognitive function of the elderly. (Hygge, S., 2001; Ranft, U., et al, 2009; Power, M. C., et al; 2011)

Despite the increasing body of knowledge related to the physical environment's impact on cognitive functioning in the field of environmental psychology, there is still a lack of a conceptual framework or assessment protocol to measure the sensitivity of different cognitive tests in assessing the impact of the physical environment. This is particularly important due to the fact that identifying the appropriate cognitive tests in evidence-based environmental design and psychology research play an essential role in providing insights and directions for researchers in the field to reach better outcomes. Additionally, measuring cognition, as one of the essential health factors, will be critical to investigate the impact of physical environment on health and well-being. Cognitive tests or tasks have been used in these studies are mainly based on environmental psychology studies and their reliability and validity have not been accurately tested. Similarly, most cognitive tests have been developed to evaluate elderly cognitive performance but failed to acknowledge the assessment of physical environmental attributes of their settings. The objective of this review is to conduct a comparative analysis between existing cognitive tests and measures to identify those sensitive architectural researches. This review followed a two-step process. First, an extensive series of cross-searches using combinations of keywords in two different fields of psychology and architecture was conducted. The search employed the EBSCO research database, which enabled the simultaneous search of multiple databases. The keyword search and cross-tabs used combinations of keywords such as 'cognitive performance', 'cognitive tests', 'cognitive assessment', 'cognitive screening' and 'cognitive impairment' in the title or the abstract through Cinahl, Embase, Medline, and PsychINFO and PsycARTICLES databases to identify the most common cognitive tests in the field of psychological studies. After finding the ten most common cognitive tests, we conducted a content analysis of their parameters and used analytical charts in order to evaluate their sensitivity to the physical environment. In addition, a supplemental search through Google Scholar and specific architectural science related journals was conducted simultaneously. The next step involved a detailed analysis of selected articles that employed widely used cognitive tests and the protocols and research design used in them.

## 2.0 LITERATURE REVIEW ON ARTICLES OF PHYSICAL ENVIRONMENT THAT ADOPTED COGNITIVE TESTS

Cognitive tests stimuli employed in field studies to measure cognitive function were identified and categorized based on their application rates and the physical attributes measured in each study. The literature shows that among the 14 studies investigating the impact of different attributes of physical environment on cognitive performance of users, seven of them used MMSE test as the main test to evaluate cognitive performance. Three of these studies employed MMSE test to measure the impact of lighting quality and quantity on cognitive performance (Graf, A., et al, 2011, Riemersma-Van Der Lek, R. F.,2008, Most, E. I, et al). Two other studies used MMSE to investigate the impact of noise, heat and air quality on cognitive performance on users. (Power, M. C., et al, 2011, Sun, R., & Gu, D., 2008), and two studies compare the impact of urban and rural areas and natural environmental availability on cognitive performance of users (Cassarino, M., et al, 2016, Wu, Y. T. et al, 2017).

Eight studies among the articles reviewed have employed other cognitive tests to evaluate cognitive performance of subjects. Ranft, U., et al (2009) employed the Battery CERAD-Plus test to measure the impact of acoustics on cognitive performance. This test originally developed as a screening tool for Alzheimer disease to test executive function and visuospatial understanding, language and memory function through 12 subtests (Schmid, N. S.,2014). Liebl, A, et al (2012) for measuring the impact of acoustic and visual distraction on attention and short-term memory has used two cognitive tests and two cognitive tasks. The Concentration Performance test applied for this study was a modified version of the original one that evaluates sustained attention or concentration through a calculation process. Other tests, such as Grammatical Reasoning was applied to investigate verbal-logical reasoning processes by measuring ability to reason about relationships among objects. In another study by Most, E. I, et al (2010) the impact of lighting quality and quantity was measured on different aspects of cognitive function by using a wide range of different cognitive tests and tasks. In this study, in addition to MMSE, Neuropsychological test battery (NTB), Stroop color/word test and Trail making test A&B, were applied in combination with other tasks. NTB covers different aspects of cognitive domains: short and long term verbal memory (the 15 Word List; the MIS+); semantic memory; working memory (Number Sequences; visual memory (the Visual Association Test) (Most, E. I.,et al, 2010). The Stroop Color and Word Test (SCWT) also are used in another study to evaluate the impact of air quality on processing speed and alertness, motor speed, inhibition and context, working memory (Schiavon, S, et al, 2017). SCWT is a neuropsychological test extensively used to assess the ability to inhibit cognitive interference that occurs when the processing of a specific

stimulus feature impedes the simultaneous processing of a second stimulus attribute, well-known as the Stroop Effect. The Stroop effect is a phenomenon that occurs when you must say the color of a word but not the name of the word (Scarpina, F., & Tagini, S., 2017). Trails Making Test (Trails) is also a neuropsychological test of visual attention and task switching. It can provide information about visual search speed, scanning, speed of processing, mental flexibility, as well as executive functioning (Delbaere, K., 2013). The Montreal Cognitive Assessment (MOCA) is a widely used screening assessment for detecting cognitive impairment which is only used in one study with MMSE to assess whether and how geographical and physical characteristics of lived environments contribute to cognitive aging. These two tests are related to global cognition, memory, speed of processing, attention, and executive functions. (Cassarino, M., et al, 2016)

In addition, studies investigating the impact of physical parameters on cognitive function were also reviewed. Each cognitive test involves answering a series of questions and/or performing tasks. These tasks are mainly a part of a cognitive test which modified or redesigned to evaluate the impact of physical environmental attributes on cognitive function based on specific aims and purposes. Simple cognitive (underlining nouns and subtracting numbers), Memory-load search, Long and short-term recall and recognition, Serial recall, Text comprehension, Match to sample visual search (MTS), Choice reaction time (CRT), Pattern recognition memory (PRM), Rapid visual information processing (RVP), Spatial span (SSP), Simple reaction time, Numerical vigilance, Category Fluency, Finger tapping and 2-Back (2B) are some of these cognitive tasks were applied to assess cognitive performance in these studies.

### 3.0 COGNITIVE FUNCTIONING TESTS REVIEWED

The top-ten most commonly employed cognitive tests in the field of environmental psychology and medicine screening for cognitive impairments are summarized below (Woodford, H. J., & George, J., 2007). This brief summary aims at categorizing the sensitivity of standardized cognitive tests to measure the impacts of the physical environment on elderly cognitive abilities.

**3.1 Mini Mental State Examination (MMSE):** The Mini Mental State Examination (MMSE) is the most commonly used cognitive screening tool in the USA, Canada and the UK by some distance (Woodford, H. J., & George, J., 2007). The Mini-Mental State Exam (MMSE) is an interviewer-administered 30-point assessment tool to assess cognitive performance and track cognitive impairment or recovery over time. This test consists of 30 questions with 30 points which are categorized as follows: orientation to time and place, registration, attention and calculation, recall, and language. The MMSE is typically administered in 5–10 min, and administration procedures are clearly explained. (Schatz, P., 2011)

**3.2 Standardized Mini Mental State Examination (SMMSE):** The standardized Mini-Mental State Examination (SMMSE) was developed in 1997 to reduce inter-rater variability in scores and increase reliability. The SMMSE incorporates the same questions as MMSE with a clearer guidance on the administration, scoring and time allocation. This test is an appropriate tool for family doctors who are the first medical professionals in identifying cognitive impairments in patients. The SMMSE needs short time to conduct it and plays an important role in detecting dementia in early stages and it is important because effective medications can be beneficial if started early. (Woodford, H. J., & George, J., 2007, Molloy, W., 2014)

**3.3 Abbreviated Mental Test (AMT):** The Abbreviated Mental Test (AMT) is a short, 10-item scale used commonly for assessing elderly patients for the possibility of dementia. It is also used for mental confusion and other cognitive impairments. This cognitive test involves short- and long-term memory as well as attention and orientation. The validity of this test is less than the MMSE test but it is simpler to perform. The validity of the test has deteriorated over time. (Oxford medical education, 2015, Woodford, H. J., & George, J., 2007)

**3.4 Six-Item Screener (SIS):** This Six-Item Screener (SIS) consists of three questions regarding time orientation and three questions of the recall task of MMSE test. Each question scores one point, and a lower score indicating more cognitive impairment. (Woodford, H. J., & George, J., 2007)

**3.5 Six-Item Cognitive Impairment Test (6CIT):** The six-item cognitive impairment test (6CIT) also known as the Short Orientation-Memory-Concentration Test is a brief cognitive test for use in primary care settings. 6CIT is an acceptable and accurate test for cognitive impairments with higher sensitivity in performance than MMSE which can be considered as a viable alternative to MMSE in the secondary care setting. (Abdelaziz and Larner, 2015)

**3.6 Clock Drawing Test (CDT):** The Clock-drawing Test (CDT) is a simple and quick exam in the neuropsychiatric assessment of patients. It assesses different cognitive domains such as attention, language skills, frontal lobe function, auditory, processing, motor programming, frustration tolerance and visuospatial skills. The patient is asked to draw a circle and then put the numbers on. Incorrect space of numbers shows visuospatial impairment, neglect, or a planning deficit. The advantage of using this test is independence from bias due to intellect, language or cultural factors. (Eknoyan, D., 2012, Woodford, H. J., & George, J., 2007)



**3.7 Mini-Cog:** It is a complementary version of the CDT test which has a three-word recall test in addition to the drawing clock task which improves memory testing. The cognitive assessment is based on a present absent of impairment and there is no numeric scale for the test. Although it makes the test easier to conduct, the test is not able to rate the severity of impairment and its progression. (Woodford, H. J., & George, J., 2007)

**3.8 General Practitioner Assessment of Cognition (GPCOG):** The GPCOG stands for the General Practitioner assessment of Cognition. This test is one of the three screening tools recommended by the Alzheimer's Association for use at the Medicare annual wellness visit. This test also consists of a recall task as well as historical questions and components testing memory of recent events and orientations.

**3.9 Montreal Cognitive Assessment (MOCA):** The Montreal Cognitive Assessment (MOCA) Test was used as an assessment for mild cognitive impairment (MCI), and after that adapted in numerous clinical settings. This test sensitivity for detecting MCI is 90%, compared to 18% for other cognitive tests such as the MMSE. MOCA can assess a variety of cognitive domains such as: short term memory, visuospatial abilities, executive functions, Attention, concentration and working memory, Language as well as Orientation to time and place. (Rosenzweig, A. S., 2020)

**3.10 Trail Making Test A&B (TMT-A&B):** The TMT is a timed test of visual conceptual and visuo-motor tracking. TMT-A mainly focuses on attention, visual search and motor function, while TMT-B measures executive functioning, speed of attention, visual search and motor function. Both parts of the Trail Making Test consist of 25 circles distributed over a sheet of paper. The results of both tests are evaluated based on time to completion and number of errors; therefore, higher scores reveal greater impairment (Dobbs, B. M., & Shergill, S. S., 2013). The difference of scores in TMT-A and TMT-B (B– A) indicates cognitive flexibility. (Vazzana et al., 2011)

#### 4.0 CONTENT ANALYSIS OF COGNITIVE TESTS

Empirical studies in the fields of psychology, medicine and therapeutics investigated the impacts of different variables on cognitive performance, using different outcomes for evaluating and assessing diagnostic tests. Most meta-analysis studies in this area have shown sensitivity and positive/negative likelihood ratios as the main critical values for assessing tests (Korsten, M. A., 2007) (Tsoi, K. K., 2015). This study has conducted a content analysis of different cognitive tests based on different criteria in order to measure their sensitivity to the physical environment. This is a comparative content analysis based on these main attributes: time, number of questions, points, cognitive domains, impact of physical environment, inventory of physical environment and physical environmental attributes involved in each test. Information regarding time for conducting studies, the number of questions, and scoring points for each test was derived from previous studies and recorded as important attributes for evaluating tests. Woodford, H. J., & George, J., (2007) used qualitative evaluation of the main cognitive domains as a tool for defining the areas of cognitive impairment. Each cognitive test assesses a particular aspect of cognition in the brain called cognitive domains. Memory, visuospatial/constructional praxis, orientation, attention/calculation, and other aspects were selected as main domains assessed within cognitive tests. The authors compared commonly used assessment tools relative to cognitive domains in a table which shows the efficiency of each cognitive test for evaluating these domains. In this study These Cognitive domains have been used as one of the criteria to evaluate the sensitivity of tests to the physical environment. Cognitive tests involve with visuospatial and orientation domains will get a higher score in terms of sensitivity to the physical environment. The score for each test has been obtained directly from the study Woodford, H. J., & George, J., (2007).

In addition, a comparative analysis of the contents of the questions were conducted to measure the impact and inventory of the physical environment. By evaluating each question, direct and indirect mentioning of the physical environment were considered as an indicator of sensitivity for each test. This indicator was tabulated and rated as impact and inventory of physical environments of a numeric scale based on the points of each question and the whole number of questions in each test. According to the contents of the questions and the exam's requirement, sensation and physical environmental attributes involved in each test were identified. (see Table 1)

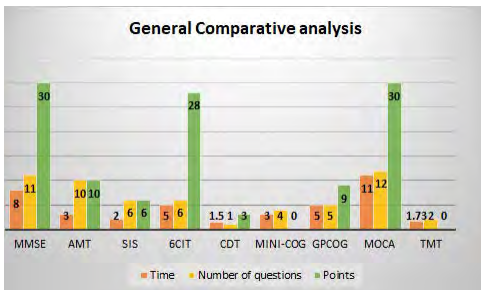
ORGANIZATIONAL PERFORMANCES  
 Mobility, Multiscalar Design and Environmental Quality

Test	Time	Number of questions	Points	Cognitive domain					Impact of physical environment	Inventory of physical environment	Involved Sensations/ physical environmental attributes
				Memory	Visuospatial/ constructional praxis	Orientation (time and place)	Attention/calculation	Other aspect			
MMSE	8	11	30	1	1	3	2	2	12/30=0.4	1/11=0.09	Vision (Light, spatial ergonomic) Auditory (acoustic)
AMT	3	10	10	3	0	2	2	0	1/10=0.1	0	Vision (Light, spatial ergonomic) Auditory (acoustic)
SIS	2	6	6	1	0	1	0	0	0	0	Auditory (acoustic)
6CIT	5	6	28	2	0	2	2	0	0	0	Auditory (acoustic)
CDT	1.5	1	3	1	2	0	1	1	3/3=1	0	Vision (Light) Auditory (acoustic)
Mini-Cog	3	4	-	2	2	0	1	1	3/6=0.5	0	Vision (Light) Auditory (acoustic)
GPCOG	5	5	9	3	2	1	1	1	2/9=0.2	0	Vision (Light) Auditory (acoustic)
MOCA	11	12	30	3	3	2	3	1	10/30=0.33	4/30=0.13	Vision (Light) Auditory (acoustic)
TMT-A&B	(A=29s, B=75s)1.73 min	2	-	1	3	3	3	1	2/2=1	0	Vision(Light) Auditory (acoustic)

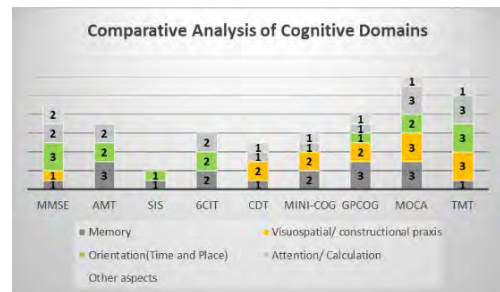
**Table 1:** Content analysis of cognitive tests

### 5.0 COMPARATIVE ANALYSIS AND FINDINGS

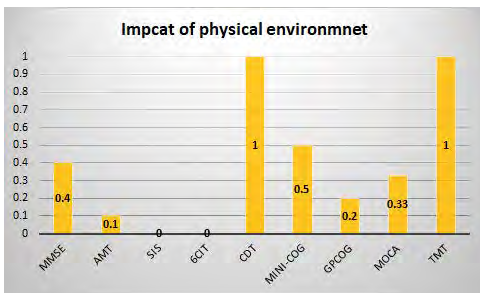
Comparative analysis of different cognitive tests indicates MMSE and MOCA tests consists of the highest number of questions and will require an average of 8 and 11 minutes to complete, respectively. The average duration to complete the other tests is five minutes or less. All cognitive tests have numeric scales for assessing cognitive impairment, except MINI-COG and TMT tests that evaluate cognitive functioning based on presence/absence of impairment and the required time to answer a question. Although it makes these tests more convenient to conduct, they are not able to rate the severity of impairment and its progression (see figure 2). Cognitive impairment is associated with at least one of the cognitive brain domains (Reger, M. A., 2004). Each cognitive test can assess a specific range of cognitive domains. In this analysis, the involvement of cognitive domains was measured and compared (memory, visuospatial/constructional praxis, orientation, attention/calculation, and other aspects) based on Woodford, H. J., & George, J., (2007). It can be concluded that processing of spatial, temporal, and social relations relies on mental cognitive maps, on which the behaving self is oriented relative to different places, events, and people (Peer, M., 2015). The ability to see an object or picture as a set of parts and then to construct a replica of the original from these parts is known as visuospatial constructive cognition (Mervis, C. B., et al, 1999). Therefore, among different cognitive domains, orientation and visuospatial/ constructional praxis are considered as an indicator to the sensitivity of different tests to measure the impacts of the physical environment. In addition, comparative analysis of cognitive domains reveals MMSE and TMT are assessing orientation domains more than other cognitive tests, while CDT and MINI-COG cannot provide any information regarding orientation domain. Among different tests investigating impairment in visuospatial/ constructional praxis domain MOCA and TMT have the highest scores. TMT among all the tests can perform better in assessing orientation and visuospatial domains with 6 scores, which renders it as an appropriate measure for the impact of the physical environment on cognitive functioning (see figure 3). In order to measure the sensitivity of each test to the physical environment the impact and inventory of the physical environment were then compared. The analysis indicates that the physical environment can impact TMT and CDT tests more than any other tests because the questions of both tests are mostly related to visual conceptual and visuo-motor tracking. Although CDT test sensitivity to physical environment is more than any other tests, this test consists of one question only, which makes it less sensitive in early stages of cognitive impairment and it should be used in combination with other tests. MINI-COG and MMSE are the other tests that have the highest sensitivity to physical environments impacts. There is no evidence, however, that shows the impact of the physical environment on SIS and 6CIT tests (see figure 4). In addition, the inventory of the physical environment for each test was also measured. This indicator shows that only MOCA and MMSE have some questions that provide an inventory list of the physical environment attributes in their content (see figure 5).



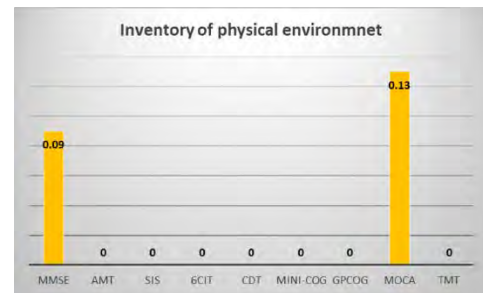
**Figure 2:** Comparative analysis of time, number of questions and points of different tests



**Figure 3:** Comparative analysis of cognitive domains between different test's



**Figure 4:** Comparative analysis of the impact of the physical environment on cognitive tests



**Figure 5:** Comparative analysis of Inventory of physical environment in different tests

## 6.0 CONCLUSIONS AND LIMITATIONS

The analysis reviewed studies of the physical environment mostly adopting cognitive tests and tasks without considering their sensitivity to the physical environment. This critical review indicated there are cognitive tests in the field of psychology which might have potential to assess the impact of physical environmental attributes on cognitive function. Among these tests in addition to MMSE which is the most common test in the field of environmental psychology, MOCA, TMT, CDT and MINI-COG are the tests that have the highest rate of sensitivity to physical environment. Researchers in Environmental psychology studies investigating the impact of different physical environmental attributes can combine and customize these tests according to the requirement of the experimental study. In addition to defined criteria's in this study for assessing cognitive tests, there are other attributes in psychological studies which assess the accuracy of these cognitive tests such as sensitivity and specificity. Sensitivity is the ability of a test to correctly identify patients with a disease and specificity is the ability of a test to correctly identify people without the disease. These two factors also play an important role in assessing cognitive tests and should be considered for choosing the appropriate cognitive test for different studies. This critical review takes the first step to identify the most sensitive and applicable cognitive tests in relationships with the physical environmental attributes to be adopted in environmental psychology and evidence-based healthcare design research. Future studies in the field are needed to investigate the applicability of the cognitive tests based on the research settings and the special populations of the study. The findings of such studies can be beneficial for evidence-based design researchers to address the impact of the physical environment on cognitive functioning and subsequently create environments that promote health outcomes.

## REFERENCES

- Abdel-Aziz, K., & Lerner, A. J. (2015). Six-item cognitive impairment test (6CIT): pragmatic diagnostic accuracy study for dementia and MCI. *International psychogeriatrics*, 27(6), 991.
- Boray, P. F., Gifford, R., & Rosenblood, L. (1989). Effects of warm white, cool white and full-spectrum fluorescent lighting on simple cognitive performance, mood and ratings of others. *Journal of Environmental Psychology*, 9(4), 297-307.
- Cassarino, M., O'Sullivan, V., Kenny, R. A., & Setti, A. (2016). Environment and cognitive aging: A cross-sectional study of place of residence and cognitive performance in the Irish longitudinal study on aging. *Neuropsychology*, 30(5), 543.
- Delbaere, K., Close, J. C., Taylor, M., Wesson, J., & Lord, S. R. (2013). Validation of the iconographical falls efficacy scale in cognitively impaired older people. *Journals of Gerontology Series A: Biomedical Sciences and Medical Sciences*, 68(9), 1098-1102.
- Dobbs, B. M., & Shergill, S. S. (2013). How effective is the Trail Making Test (Parts A and B) in identifying cognitively impaired drivers? *Age and ageing*, 42(5), 577-581.
- Eknoyan, D., Hurley, R. A., & Taber, K. H. (2012). The clock drawing task: common errors and functional neuroanatomy. *The Journal of Neuropsychiatry and Clinical Neurosciences*, 24(3), 260-265.
- Graf, A., Wallner, C., Schubert, V., Willeit, M., Wilk, W., Fischer, P., ... & Neumeister, A. (2001). The effects of light therapy on mini-mental state examination scores in demented patients. *Biological Psychiatry*, 50(9), 725-727.
- Gasio, P. F., Kräuchi, K., Cajochen, C., van Someren, E., Amrhein, I., Pache, M., ... & Wirz-Justice, A. (2003). Dawn–dusk simulation light therapy of disturbed circadian rest–activity cycles in demented elderly. *Experimental gerontology*, 38(1-2), 207-216
- Graf, A., Wallner, C., Schubert, V., Willeit, M., Wilk, W., Fischer, P., ... & Neumeister, A. (2001). The effects of light therapy on mini-mental state examination scores in demented patients. *Biological Psychiatry*, 50(9), 725-727.
- Hygge, S., & Knez, I. (2001). Effects of noise, heat and indoor lighting on cognitive performance and self-reported affect. *Journal of Environmental Psychology*, 21(3), 291-299.
- Knez, I. (1995). Effects of indoor lighting on mood and cognition. *Journal of environmental psychology*, 15(1), 39-51.
- Kelly, M. E., Loughrey, D., Lawlor, B. A., Robertson, I. H., Walsh, C., & Brennan, S. (2014). The impact of exercise on the cognitive functioning of healthy older adults: a systematic review and meta-analysis. *Ageing research reviews*, 16, 12-31.
- Kempermann, G. (2008). The neurogenic reserve hypothesis: what is adult hippocampal neurogenesis good for?. *Trends in neurosciences*, 31(4), 163-169.
- Korsten, M. A. (2007). Application of summary receiver operating characteristics (sROC) analysis to diagnostic clinical testing. *7 Reflections on the future of gastroenterology–unmet needs*, 52, 76.
- Lamport, D. J., Saunders, C., Butler, L. T., & Spencer, J. P. (2014). Fruits, vegetables, 100% juices, and cognitive function. *Nutrition reviews*, 72(12), 774-789.
- Lezak, M. D. (2004). Chapter 16, executive functions and motor performance In: MD Lezak, editor,; DB Howieson, editor,; DW Loring, editor., ed.
- Liebl, A., Haller, J., Jödicke, B., Baumgartner, H., Schlittmeier, S., & Hellbrück, J. (2012). Combined effects of acoustic and visual distraction on cognitive performance and well-being. *Applied ergonomics*, 43(2), 424-434.
- Mervis, C. B., Robinson, B. F., & Pani, J. R. (1999). Visuospatial construction. *The American Journal of Human Genetics*, 65(5), 1222-1229.

- Most, E. I., Scheltens, P., & Van Someren, E. J. (2010). Prevention of depression and sleep disturbances in elderly with memory-problems by activation of the biological clock with light-a randomized clinical trial. *Trials*, 11(1), 1-9.
- Patnaik, B., Lawton, M. P., Kleban, M. H., & Maxwell, R. (1974). Behavioral adaptation to the change in institutional residence. *The Gerontologist*, 14(4), 305-307.
- Power, M. C., Weisskopf, M. G., Alexeeff, S. E., Coull, B. A., Spiro III, A., & Schwartz, J. (2011). Traffic-related air pollution and cognitive function in a cohort of older men. *Environmental health perspectives*, 119(5), 682-687.
- Ranft, U., Schikowski, T., Sugiri, D., Krutmann, J., & Krämer, U. (2009). Long-term exposure to traffic-related particulate matter impairs cognitive function in the elderly. *Environmental research*, 109(8), 1004-1011
- Reger, M. A., Welsh, R. K., Watson, G., Cholerton, B., Baker, L. D., & Craft, S. (2004). The relationship between neuropsychological functioning and driving ability in dementia: a meta-analysis. *Neuropsychology*, 18(1), 85.
- Riemersma-Van Der Lek, R. F., Swaab, D. F., Twisk, J., Hol, E. M., Hoogendijk, W. J., & Van Someren, E. J. (2008). Effect of bright light and melatonin on cognitive and noncognitive function in elderly residents of group care facilities: a randomized controlled trial. *Jama*, 299(22), 2642-2655.
- Satlin, A., Volicer, L., Ross, V., Herz, L., & Campbell, S. (1992). Bright light treatment of behavioral and sleep disturbances. *Am J Psychiatry*, 149, 1028.
- Scarpina, F., & Tagini, S. (2017). The stroop color and word test. *Frontiers in psychology*, 8, 557.
- Schatz, P. (2011). Mini-Mental State Exam. *Encyclopedia of Clinica*
- Schiavon, S., Yang, B., Donner, Y., Chang, V. C., & Nazaroff, W. W. (2017). Thermal comfort, perceived air quality, and cognitive performance when personally controlled air movement is used by tropically acclimatized persons. *Indoor air*, 27(3), 690-702.
- Schmid, N. S., Ehrensperger, M. M., Berres, M., Beck, I. R., & Monsch, A. U. (2014). The extension of the German CERAD neuropsychological assessment battery with tests assessing subcortical, executive and frontal functions improves accuracy in dementia diagnosis. *Dementia and geriatric cognitive disorders extra*, 4(2), 322-334.
- Simmons, S. E., Saxby, B. K., McGlone, F. P., & Jones, D. A. (2008). The effect of passive heating and head cooling on perception, cardiovascular function and cognitive performance in the heat. *European journal of applied physiology*, 104(2), 271-280.
- Sun, R., & Gu, D. (2008). Air pollution, economic development of communities, and health status among the elderly in urban China. *American journal of epidemiology*, 168(11), 1311-1318
- Taylor, L., Watkins, S. L., Marshall, H., Dascombe, B. J., & Foster, J. (2016). The impact of different environmental conditions on cognitive function: a focused review. *Frontiers in physiology*, 6, 372.
- Vazzana, R., Bandinelli, S., Lauretani, F., Volpato, S., Lauretani, F., Di Iorio, A., ... & Ferrucci, L. (2010). Trail Making Test predicts physical impairment and mortality in older persons. *Journal of the American Geriatrics Society*, 58(4), 719-723.
- Woodford, H. J., & George, J. (2007). Cognitive assessment in the elderly: a review of clinical methods. *QJM: An International Journal of Medicine*, 100(8), 469-484.
- Wu, Y. T., Prina, A. M., Jones, A., Matthews, F. E., & Brayne, C. (2017). The built environment and cognitive disorders: results from the cognitive function and ageing study II. *American journal of preventive medicine*, 53(1), 25-32.
- Yamadera, H., Ito, T., Suzuki, H., Asayama, K., Ito, R., & Endo, S. (2000). Effects of bright light on cognitive and sleep-wake (circadian) rhythm disturbances in Alzheimer-type dementia. *Psychiatry and clinical Neurosciences*, 54(3), 352-353.

# Walking the Walk: Pedestrian Mobility in Emerging Cities

Diana Maria Jiménez-Aguilar<sup>1</sup>, Luisa María Gutiérrez-Sánchez<sup>1</sup>, Rosa María Mendoza-Robles<sup>1</sup>

<sup>1</sup>University of Sonora, Hermosillo, Mexico

**ABSTRACT:** Through the Sustainable Development Goals, cities are intended to be sustainable, inclusive, and resilient (UNDP 2016). In the hierarchy of urban mobility, a walkable city promotes equity and social benefit with the least impact on the environment (NACTO 2016). This paper addresses pedestrian mobility through the analysis of the street. Walkability can be a complex concept but definitions concur in referring to qualities of the environment that make walking possible and desirable (Speck 2013). The possibility of walking is not only related to mobility, it is also part of a broader discussion regarding living conditions and options for people within the city (Gehl 2014).

This case study takes place in Hermosillo, the capital city of Sonora, Mexico. Located approximately 280 km from the border with Arizona in the United States - within the Sonoran Desert. Hermosillo has a population of just over 855 000 inhabitants (INEGI 2020). It is considered by the Inter-American Development Bank (IDB) an emerging city with optimal characteristics to guide its growth towards a more sustainable, resilient, and inclusive future. The street selected for this paper has its origins in downtown, the oldest neighborhood of the city, and extends west, towards the most recent developments. One part of the analysis is made by establishing historic stages of development of the street. Later, aiming to recognize policies in the built environment, on-site measuring was made a), by measuring walkways width in different segments to find how pedestrian spaces have evolved and b), by applying a walkability tool for an assessment of each stage. Results show a discrepancy between the discourse in development plans and the built environment among the street. This work in progress poses the question of how does a city embraces the consequences of modernization and industrialization that impact the human scale.

**KEYWORDS:** walkability, pedestrian, street design

## INTRODUCTION

A street is the basic unit of the urban area and also a testimony to the historical narrative of the city. Streets are dynamic spaces that adapt and change over time. For several decades' street design has been focused on moving a large number of vehicles as efficiently as possible. Nowadays, the paradigm of sustainable urban mobility encourages cities to design livable and safe streets that balance the needs of all users, prioritizing public transit and non-motorized travel (NACTO 2016). Every trip begins and ends with a walk, therefore everyone is a pedestrian on a city's street at some point. The study of the street from the pedestrian point of view involves the majority of the inhabitants of the city, regardless of their main means of transport. By structured streetscape observations and on-site measurements, this paper seeks to reveal the evolution of sidewalks and walkability conditions over time. It also explores the correlation between discourse in development plans and the physical characteristics of the built environment.

Cities typically improve vehicular rights of way at the expense of pedestrians to accommodate traffic congestion that results from rapid rates of motorization. In many low- and middle-income countries, walking still accounts for the largest proportion of trips taken; however, pedestrian infrastructure and amenities are often neglected in planning and budgets (Krambeck 2006). In emerging cities, vehicle ownership and use grow more rapidly than the available space on roads, resulting in increased congestion. When street planning focuses on free-flowing transit, walking becomes less safe, less convenient, and less attractive. Despite the well-known benefits of walking, it tends to be ignored as a means of transportation by policymakers in the formulation of infrastructure policy (Gwilliam 2002). In this paper, the analysis of the evolution of sidewalks seeks to answer whether more space for pedestrians improves walkability in the street. The sections of the street with the best walkability are matched with its historical timeline in the city to find out if new developments address current issues and therefore are oriented towards sustainable urban mobility.

## 1.0 BACKGROUND

### 1.1. Site

Hermosillo is the capital city of the state of Sonora in the Northwest region of Mexico. Its geographical location is in the central part of the state, approximately 280 km from the border with the United States and just under 110 km from the Gulf of California. The main economic activity is in commerce and services; followed by industrial and construction



activity and a lower percentage is found in the agricultural sector. Its location and communication network facilitate commercial exchange in the region. The population is estimated at 855 563 inhabitants and its economic growth is above the national average (INEGI 2020).

As for the natural environment, Hermosillo is located within the Sonoran Desert. Under the Köppen classification, it has a desert climate BW (h') hw (x') warm very dry with rains in summer. The average annual temperature is above 24 °C and the average maximum temperature is 34 °C, reaching an absolute maximum of 48.5 °C in 2016. The average annual precipitation is 24.8mm, below the state average.



**Figure 1.** Aerial view of Colosio Blvd towards east direction. (Photos by author 2020)



**Figure 2.** Aerial view of Colosio Blvd towards west direction.

## 1.2 Population

The city has had a pattern of horizontal urban expansion for decades. The urban area increased more than three times its size between 1980 and 2010, at a faster rate than its population. In the economic context of Hermosillo, in the eighties, the city went from having mainly agricultural activities to a greater industrial activity after the arrival of the Ford Motor Company's automobile assembly plant in 1986. With the diversification of economic activities, a challenge of urban planning arises with the demand for more housing, public spaces, and infrastructure. On the ideological side, by the nineties, modernity was sought through megaprojects and the construction of new roads (Rodriguez-Duarte 1996). Partly because of the proximity to the US border and American cities, the automobile has been considered a symbol of prosperity and progress. Therefore, the modernization of the city has been related to the expansion of the urban area and an extended street network that connects new developments with the city center. This type of development has maintained a low urban density as the area grows faster than the population as shown in Table 1.

**Table 1:** Urban density over time. Source: (IMPLAN 2016)

	1980	1990	2000	2010
<b>Urban land (km<sup>2</sup>)</b>	48.11	74.22	111.29	171.80
<b>Inhabitants</b>	297,175	406,417	545,928	715,006
<b>Urban density (people per km<sup>2</sup>)</b>	6,176.99	5,475.84	4,905.45	4,161.85

## 1.3 Mobility

Urban mobility refers to movements on a different scale, spatial and temporal, carried out in an urban system. According to a survey of transportation carried out by the city planning department in 2015, most of the trips are made by private vehicle, followed by public transit. Comparing the information from 2003 and 2013, the use of private vehicles has slightly surged; public transit is increasingly used but pedestrian mobility has decreased considerably as shown in Table 2. According to the Municipal Planning Institute of Hermosillo, the city currently does not have a pedestrian network. As the city grows inward and outward to serve changing populations, it becomes important to understand actors and processes that intervene in the development of the streets that shape the city.

**Table 2:** Means of transportation in Hermosillo over a decade. Source: (IMPLAN,2015)

	2003	2013
<b>Private vehicle</b>	44%	48%
<b>Bus</b>	29%	42%
<b>Bike</b>	1.5%	3%
<b>Walk</b>	24.5%	5%
<b>Other</b>	1%	2%

## 2.0 METHODOLOGY

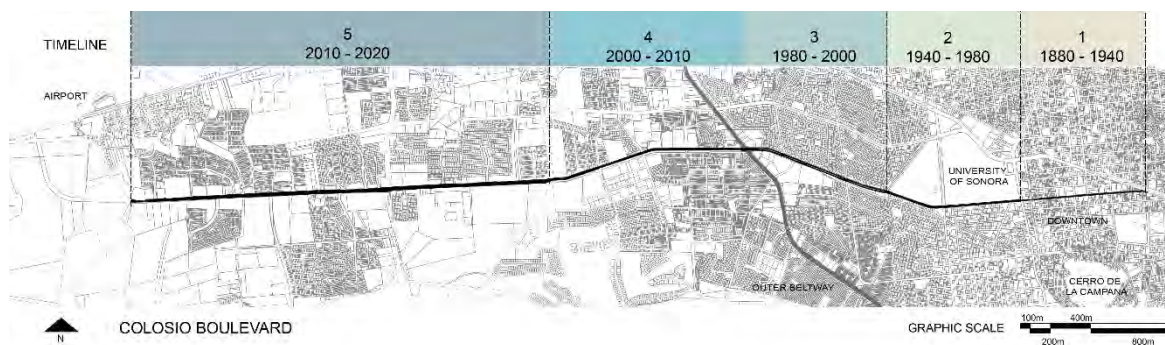
The analysis of one main street in Hermosillo starts with a synthesis of the historical periods and events in which the street was integrated into the city grid exploring the aspects of its design over time. Once the stages of development have been defined, the width of walkways along the road is measured to obtain physical qualities representative of each period. On-site measurements of every element of the road were made within the area of each stage on both sides of the street and repeated at three different points to obtain an average width.

In the next part, a walkability tool is applied to obtain a score on the conditions that encourage (or not) pedestrian mobility at each stage of development. The Pedestrians First tool (ITDP 2020) was selected for this study for having the option of being applied at a small scale, at street level. The assessment includes three factors: infrastructure, activity, and priority. Data is collected during an in-person visit to the street and filling a checklist on a mobile device. The checklist consists of 9 sections and 43 points to observe with the option of answering yes or no. Once the questionnaire is answered, a score is given with the highest value being 43/43. This tool is applied once in each development stage of the street.

## 3.0 CASE-STUDY

### 3.1. Street selection

A street is a fragment of the city that can be studied from its trace, its form, the social activities it holds, or by the name and memory it carries (Lindón 2007). From the analysis of main roads in the city and its origin-destination qualities, Luis Donaldo Colosio Boulevard was selected for this study. The street was chosen for its origin in the historic district and its growth toward the newest developments, encompassing urban sprawl. For this analysis, Colosio Blvd. is divided into five stages of development; (S1) from late 1800 to 1940; (S2) from 1940 to 1980; (S3) from 1980 to 2000; (S4) from 2000 to 2010 and (S5) from 2010 to 2020. (See Fig. 3)



**Figure 3.** Colosio Boulevard stages of development. Source: (Author, 2020).

#### 3.1.1 Historic approach

The founding period of what now is Hermosillo occurs throughout the 18th century, following the sequence town-presidium-town-city. Villa del Pitic changes its name to Hermosillo city in 1825 and becomes State capital in 1879. When the railway line was installed in 1881, Hermosillo was connected to the port of Guaymas and Nogales on the American border. By the end of the 19th century, technological networks such as telephones, telegraph, drinking water, trams, and electricity would be implemented, increasing the possibility of urban expansion (Mendez Sainz 2003).

S1. The origin of the Colosio boulevard can be traced around 1900 with the expansion of the urban grid towards the railway tracks. The configuration of downtown initially was made of housing, small shops, and essential urban amenities, later the railroad will integrate the city into the country's urban system. By 1920 population was less than 20 000 inhabitants. The streets built around this period, with an east-west direction were named after Mexican States, among them was Yucatán Avenue known today as Colosio Boulevard. Since its beginnings the social and commercial relevance of Yucatán Avenue can be appreciated from the built environment surrounding it; a mill, a public square, and a military guardhouse were among the main facilities.

S2. By the 1940s, development many projects with a nationalistic identity were aiming to place Hermosillo as an important capital city in the country. The project for the University of Sonora attempted to reinforce secular and modern ideals oriented to scientific and technical development. Buildings that encompassed a sense of modernity were introduced in the urban landscape; they were modern not only in their architecture but in the symbolic representation of their use, such as a medical clinic, a cinema, and car dealerships. On the way to globalization, during the fifties, the popularity of the automobile was brought in from abroad as a symbol of progress and prosperity, and some of the first dealerships were installed on Yucatán Avenue. Population in the early '50s was around 54 000 inhabitants and by 1960 it was more than 118 000.

Over this period Hermosillo continued to extend, creating neighborhoods that imitate American suburbs self-segregating from the city. Planning a car-dependent city gradually turned its back on pedestrian and public transit mobility. In the sixties, an outer beltway was built to restrict urban areas. City planning originally conceived for 20,000 inhabitants, was surpassed by 1970, with the population reaching over 170 000 inhabitants. This period of progress and modernization from the 1940s to 1970s reached a limit in terms of functionality and operation of the road system, as well as public infrastructure, state and civil architecture (Castro Silva 2008).

S3. In the late 1980s, Ford's Company assembly plant was installed in Hermosillo, which exerted pressure on the need for new spaces for a growing population. Development projects that planned to expand and modernize city roads began to flourish, intensifying the use of private vehicles (Rodriguez-Duarte 1996). In the nineties, at the intersection of Yucatán avenue and the outer beltway a new commercial urban center was proposed. Under a discourse of competitiveness, private investment, job creation, and improvement of quality of life it intended to allocate a business center and American franchises of fast food and entertainment. Urban planning in this period responds mainly to demands of the productive sectors and power groups that would establish the strategies to modernize the city (Rodriguez-Duarte 1996). By 1992, Yucatan avenue modernization was completed and in 1994 changed its name to Luis Donaldo Colosio Boulevard, in memory of a politician from Sonora who was assassinated during his campaign as a presidential candidate. Population by the 1990s reached over 440 000 inhabitants but the economic crisis in Mexico in the mid-1990s delayed the construction of new projects and urban facilities.

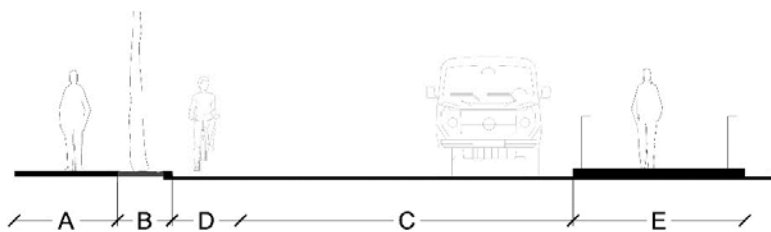
S4. By the year 2000, the increasing population and the need for more spaces exceeded the capacity of plans and policies (Ojeda, Narváez-Tijerina y Quintana-Pacheco 2014). At this point, housing was one of the main concerns for the city, and land-use in the west part of Colosio Boulevard was planned for residential use. Developers that intended to build suburban housing in this boulevard were in charge of the feasibility of services (water, drainage, and electricity) and infrastructure, including paving, and street connections. By now, the urban area has already exceeded its limits established in previous years. The development of suburban housing created urban islands, away from services and workplaces. Roads became the primary structure of city growth continuing the tendency of a car-dependent city. Yet, the discourse in this decade starts to address climate concerns that it will show in the new objectives of its development plans.

S5. From 2010 to date, constructions had been located even further from the urban area. In 2011 the construction of Sonora Stadium was proposed as the main project of a new urban complex. This megaproject was announced as an urban center with mixed-use buildings surrounded by natural environments, away from city chaos. The main access was through Colosio Boulevard but public transit was not included in the original project relying on the private vehicle to get around. The Stadium was built in 2013, however, the rest of the development didn't continue as planned in the next administration. By 2018 city planning allowed natural preservation zones to be used as mixed-use zone and low-density housing (IMPLAN 2018). Even when new plans and programs aim to address climate concerns, the old urban practices continue. This last segment of the street has ongoing urbanization, by 2020 it holds mainly residential areas, commercial strips, and vacant lots.

### 3.2. Walkways

Standards for sustainable mobility recommend sidewalks with a clear path width between 1.80m to 2.40m in residential areas and between 2.4m to 4.5m in areas of commercial use (NACTO 2016). Local regulations in Hermosillo, in 2006 established that a clear path in the sidewalk must be 1.80m with an additional curb strip of 0.90m to hold trees that provide shade and shelter. In the current Development Program (IMPLAN 2018) the width of sidewalks is to be determined by the road width and the number of lanes it holds. In a 4-lane primary road, clear paths in sidewalks must be 4.50m and 1.00m for curb strips. In local streets with two lanes, clear paths must be 2.00m and 1.00m for curb strips. However, the Complementary Technical Standards for Construction Regulations (2018) which are issued by the municipal authorities, allow a minimum width for sidewalks of 2.00m total; 1.50m for the clear path, and 0.50m for curb strips. This discrepancy allows that Programs can plan according to international standards aiming to sustainable mobility, but in practice, Construction Regulation allows minimum widths of sidewalks that don't meet the same criteria. In this regulatory context, is pertinent to analyze sidewalks and recognize codes and policies that were applied over time.

The width of the street varies through every stage of development. Even within the same stage, the dimensions and components can change from one block to another. For each stage of development, measures were taken at three different points of the street to obtain an average width that can be representative of its time. Figure 4 shows how the street is mainly composed and the width of each element can be found in Table 3.



**Figure 4.** Road section. A: Clear path. B: Curb strip. C: Roadway. D: Bike lane. E. Median or refuge island. (Author, 2020)

**Table 3.** Average dimensions of the elements of the street.

	S1	S2	S3	S4	S5
<b>A</b> Sidewalk width (m)	1.64	2.06	2.10	1.90	2.3
<b>B</b> Curb strip width (m)	0.40	0.65	3.93	1.67	1.33
<b>C</b> Roadway width (m)	5.60	6.20	9	9.30	9.90
Travel lanes	1	2	3	3	3
<b>D</b> Bike lane (m)	No	No	1.20	2.00	1.55
<b>E</b> Medians or refuge islands	No	Partly	4.00m	6.50m	8.50
On street parking	Yes	No	Yes	No	No
Block density (blocks per km <sup>2</sup> )	131	85	92	80	13

Block density was added in Table 3 as it is an indicator that measures connectivity and urban infrastructure. This metric shows the number of blocks per square kilometer of the urban area supported by Geographical Information Systems (INEGI 2016). A block is an area bounded by public streets; a higher value in block density allows more direct pedestrian routes, decreases the need for mid-block crossings, requires vehicles to stop more frequently, slowing down and making walking safer. The higher the density, the street facade length increases allowing more destinations per block, shortening walking duration. It has an important role in walkability assessment, however, block density does not take into account the activity or priority of pedestrians.

### 3.3. Walkability

In a revision of literature, many walkability indices can be found; different disciplinary understandings of an object result in different classifications of variables (Shashank y Schuurman 2019). Often the selection of an instrument to measure walkability is made according to the research field and objectives; it can be used for real estate purposes, public health, or urban planning. The weight of variables can change in methodologies; tools that incorporate quantitative, as well as qualitative aspects, yield more comprehensive results. There is complexity in the concept of walkability and its relation to design; qualities that make a space walkable can be shaped by cultural and social aspects that change from one place to another (Forsyth 2015). The walkability tool selected for this paper aims to give an overview of the street to be contrasted with on-site measurements and historical background.

Pedestrians First tool (ITDP 2020) assesses three factors: infrastructure, activity, and priority. *Infrastructure* refers to the features such as sidewalks, crosswalks, signage, and transit services that facilitate movement; *activity* refers to features that determine where people and destinations are located; *priority* refers to the aspects of transportation that give preference to sustainable modes over private cars. To assess walkability this tool provides a checklist divided into 9 sections: walkways, comfortable and dignified environment, personal security, crossings, road safety, parking, walkway amenities, transit access, and streets for babies. Each section lists five or more descriptions to observe on-site and the option to answer yes or no if it meets the requirements. The checklist is filled on a mobile device in an in-person visit to the street and a score is given when completed. The highest value is 43/43 and the lowest 0/43. (See results in Table 4)

**Table 4:** Average dimensions of the elements of the street.

	S1	S2	S3	S4	S5
<b>Walkways</b>	1/4	1/4	2/4	2/4	1/4
<b>Comfortable environment</b>	2/5	2/5	3/5	4/5	4/5
<b>Personal Security</b>	2/4	3/4	2/4	2/4	1/4
<b>Crossings</b>	6/8	3/8	1/8	2/8	2/8
<b>Road Safety</b>	3/4	2/4	0/4	1/4	1/4
<b>Parking</b>	3/3	2/3	2/3	1/3	2/3
<b>Walkway Amenities</b>	3/6	1/6	1/6	1/6	1/6
<b>Transit Access</b>	2/3	1/3	0/3	1/3	0/3
<b>Streets for babies</b>	0/6	0/6	0/6	0/6	0/6
<b>Walkability score</b>	<b>22/43</b>	<b>15/43</b>	<b>11/43</b>	<b>14/43</b>	<b>12/43</b>



#### 4.0 PRELIMINARY FINDINGS

Results obtained from streetscape observation and walkability assessment in each stage are contrasted with its historical period of development. In downtown, the historical district of the city (S1) the average sidewalk width is 1.64m and its walkability score is 22/43; it is the narrowest sidewalk and yet has the best score in walkability. In this section, Colosio Blvd is a one-way street, there is very low population density; people living in houses surrounding Colosio Blvd are less than 300 according to 2016 estimates (INEGI 2016). Walking activity is high by day; students, government workers, and merchants are seen. Streetscape observation took place in winter when daytime weather is cool and sunny in Hermosillo. However, downtown is active throughout the year, even in the months when the temperature exceeds 40°C in summer at noon. It is a busy place, private vehicles, public transport, and non-motorized transport interact daily (See Fig. 4). Facades that surround Colosio Blvd have many shapes and textures. Some of the original architecture is conserved and there are currently no codes that regulate facades so a variety of colors and signage is found. Often there is a smell of food, but it can be mixed with the smell of automotive exhaust. Walking accounts for most trips as it is faster than moving in a car through the narrow and congested streets. The walking experience can be perceived as uncomfortable; however, it is practical. Street blocks that are short and permeable, connected to public transit within distances no greater than 500m. Nevertheless, even with the highest score of walkability, only half of the characteristics of a walkable environment were met.

The next section (S2) has an average sidewalk of 2.06m wide and its walkability score is 15/43. As the number of lanes increases, so does the speed of motorized vehicles. The walking experience becomes less appealing; most destinations prioritize access by car. Despite being surrounded by the university campus, the absence of public transport in this section reduces pedestrian activity. Based on elements of The City Image (Lynch 1960) Colosio is perceived more as an edge than as a path. A residential area for the middle-upper class is allocated on the south side and the university campus on the north side. Pedestrians in this area belong to different social backgrounds and have different activities; social interactions are rare. Population density is low people living in the surrounding neighborhood is around 150 inhabitants (INEGI 2016), the most area encompasses the university campus. Street blocks are longer than the previous section, a lower value on block density increases the walking duration and the environment makes it less desirable.



**Figure 4.** Streetscape from sections 1 and 2. (Photos taken by author 2020)

In the third section (S3) the average sidewalk width is 2.10m yet has the lowest walkability score. Sidewalks have optimal qualities but pedestrians are less seen, destinations favor access by car. The street has one more lane than the previous section and traffic is divided by a median with tall palm trees. Unlike downtown (S1) where facades are directly adjacent to the sidewalk and roads are narrow, space here is perceived as more open. Building's facades are separated from the walkways creating some sort of soft edges. The land-use codes and regulations establish low-height buildings (1 or 2 floors) and there is no significant vegetation; shade and shelter on sidewalks are scarce. Cafes and restaurants are observed but mainly in enclosed spaces, social interaction is generally poor. The population density in the immediate surroundings is low, shops are predominant. Space can be perceived as wider and with softer edges, but the speed limit (80 km/hr) on the street can make walking feel unsafe (See Fig. 5). These qualities of the built environment are hostile to pedestrian activities and do not encourage permanence in the street.

The fourth stage (S4) has an average sidewalk width of 1.90 and a walkability score of 14/43. Streetscape remains similar to the previous section; however, this area has access to public transport; bus stops enhance pedestrian activity. Block density is low; less connectivity and lack of shade maintain a hostile environment for walking especially in the warmer months (May through October). Vegetation is mainly found in medians that divide the street as part of the urban landscape, not as elements that favor pedestrians. Shapes and textures of the facades are made to be seen from afar; large text on the advertisement, bright colors, and flat surfaces well-lit that can be seen from moving vehicles. The sensory experience as a pedestrian becomes poorer as we move away from downtown. There are some restaurants and shops that remain open at night, contrary to downtown that becomes uninhabited by night. After all, the street may be busy but social interaction is not frequent.

Finally, in the last stage (S5), the average sidewalk width is 2.30 and a walkability score is 12/43. The land is mainly used by enclosed residential developments that restrict public access diminishing the number of possible destinations. Population density is high, just one of these enclosed residential allocates up to 850 inhabitants. Pedestrian activity is generally low; people can be seen walking as a form of exercise when the weather is not extreme but. In the surroundings of the Sonora Stadium, which is the western boundary of this case study, there is more leisure activity, yet people get there mainly by car. This section is 4km long, the longest of all five stages; it shows a trend towards horizontal development and low density in the latest decades. Blocks do not meet the criteria of being bounded by public streets which decreases block density. This area of the city is still under development and there are many vacant lots. This part of the street can be perceived as deserted; from a pedestrian perspective the street seems long and uninhabited, it has no significant vegetation or shelter; the human scale is lost. When traffic is low, the wind passing by is the only sound.



Figure 5. Streetscape from sections 3 – 5. (Photos taken by author 2020)

## CONCLUSION

Analyzing the city through a historical approach to the street allows us to reflect on the events that have shaped it. When city diagnostics are based on vehicles as the main users of the street, a large part of the population is being excluded from street design and city planning. The preliminary findings in this ongoing research show that even when a larger area is dedicated to pedestrians, it does not improve walkability. Also, a densely populated area without possible destinations does not enable walking. Connectivity, permeability, and activity have a greater impact on pedestrian's motivation to walk. The historic district has a more walkable environment than the newer developments and it raises questions over the discourse of the city's planning towards sustainable, resilient, and inclusive models. Sidewalks are not the only element that determines the walkability of the environment; however, their physical qualities can reveal the importance of pedestrians in city planning. In the specific case of emerging cities in developing countries, they are presumably still capable of planning and directing growth with consideration of human scale. As shown in this paper, as the city grows, the lack of attention to pedestrian infrastructure continues to foster a car-dependent city. Walkability is often assessed in developed countries and cities and used as a tool that aims to improve quality of life. Nevertheless, assessing walkability in emerging cities and its relationship with its historic context intends to put the spot on pedestrians where walking still accounts for the largest proportion of trips taken. Hopefully, analyzing the streets from a pedestrian view can eventually lead to resume their right of way.

## REFERENCES

- Ayuntamiento de Hermosillo. *Normas Técnica Complementaria al Reglamento de Construcción para el Municipio de Hermosillo. Características y Requerimientos del Proyecto Arquitectónico*. Reglamento, Hermosillo: Ayuntamiento de Hermosillo, 2018.
- Castro Silva, Tonatiuh. *Sonora Diversidad*. 8 de diciembre de 2008. <http://sonoradiversidad.blogspot.com/2008/12/la-refundacin-espacial.html>.
- Forsyth, Ann. «What is a walkable place? The walkability debate in urban design.» *URBAN DESIGN International*, Octubre 2015: 274–292.
- Gehl, Jan. *Ciudades para la gente*. Décima. Traducido por Juan Decima. Buenos Aires: Ediciones Infinito, 2014.
- Gwilliam, Ken. *Cities on the move: a World Bank urban transport strategy review*. Washington, DC: World Bank, 2002.
- Habibia, S., y N. Asadi. «Causes, results and methods of controlling urban sprawl.» *International Conference on Green Buildings and Sustainable Cities*. Bologna: Curran Associates, Inc., 2010. 133-141.
- IMPLAN. *Programa de Desarrollo Metropolitano de Hermosillo*. Instituto Municipal de Planeación de Hermosillo, Hermosillo: IMPLAN, 2016, 95.
- IMPLAN. *Programa Municipal de Ordenamiento Territorial de Hermosillo*. Boletín oficial, Hermosillo: Instituto Municipal de Planeación Urbana de Hermosillo, 2018.
- INEGI. «Censo de Población y Vivienda 2020.» Sistema de Consulta de Información Territorial. Principales resultados por localidad., Instituto Nacional de Estadística y Geografía, México, 2020.



- . *Inventario Nacional de Viviendas*. 2016. <https://www.inegi.org.mx/app/mapa/inv/> (último acceso: 16 de Febrero de 2021).
- ITDP. *Institute for Transportation & Development Policy. Pedestrians First*. 2020. <https://pedestriansfirst.itdp.org/street> (último acceso: diciembre de 2020).
- Krambeck, Holly Virginia. «The Global Walkability Index.» Doctoral dissertation, Massachusetts Institute of Technology, 2006.
- Lindón, Alicia. «La ciudad y la vida urbana a través de los imaginarios urbanos.» *Revista eure* XXXIII, n° 99 (agosto 2007): 7-16.
- Lynch, Kevin. *The Image of the City*. Traducido por Enrique Luis Revol. Cambridge, Massachusetts: The Massachusetts Institute of Technology Press, 1960.
- Mendez Sainz, Eloy. *Hermosillo en el siglo XX. Urbanismos incompletos y arquitecturas emblemáticas*. Hermosillo: El Colegio de Sonora, 2003.
- NACTO. *Global Street Design Guide*. Nueva York: Island Press, 2016.
- Ojeda, Arturo, Adolfo Benito Narváez-Tijerina, y Jesús Quintana-Pacheco. «Gestión del agua doméstica urbana en Hermosillo (Sonora, México).» *Revista Colombiana de Geografía* 23, n° 1 (enero-julio 2014): 147-164.
- Rodríguez-Duarte, Omar. «Estudio sobre proyectos y obras públicas en la ciudad de Hermosillo 1992-1994.» Hermosillo, Sonora: El Colegio de Sonora, Septiembre de 1996.
- Shashank, Aateka, y Nadine Schuurman. «Unpacking walkability indices and their inherent assumptions.» *Health & Place*, 2019: 145-154.
- Speck, Jeff. *Walkable City: how downtown can save America, one step at a time*. Nueva York: North Point Press, 2013.
- UNDP. *Human Development Report. Human Development for Everyone*. Human Development Report, New York : United Nations Development Programme, 2016.

PERFORMATIVE ENVIRONMENTS  
Technological, Organizational and Cultural Performances

# PERFORMATIVE ENVIRONMENTS

**Research Poster Abstracts**  
**ARCC 2021 International Conference**

# The Design and Fabrication of Façade Panel Systems with Additive Manufacturing

Tanner Theisen<sup>1</sup>, Niloufar Emami<sup>1</sup>

<sup>1</sup>Louisiana State University, Baton Rouge, LA

**ABSTRACT:** The purpose of this study is to explore the possibilities of additive digital fabrication techniques for customized repetitive manufacturing (CRM) as they apply to the design and fabrication of molds for precast concrete panels. These digital fabrication methods are distributed enough that they are accessible, and the elements produced through these methods can have geometrical freedom compared to those produced through traditional methods. Volumetric concrete panels are the focal point of this study. These panels have been advancing in their design, but the general fabrication methods in practice have not been catching up with this advancement. Producing concrete panels by employing traditional mold making methods restricts the geometric possibilities of their design, while it also limits the involvement of a designer in prototyping and fabricating panels. This study proposes 3D printing molds as an alternative fabrication method for creating precast building elements. After completing a review of precast paneling systems in over forty case studies, the design and fabrication techniques employed in each project were interrogated. Next, two case studies, namely Le Vêrone Tower and The Perot Museum of Nature and Science were studied in depth. The issues of controlled variability by using 3D printed molds were tested through pushing the design aesthetics of these projects. Stereolithography (SLA) resin printing was the key process employed for recreating these panels. Considering both the available and upcoming large scale 3D printers in the industry, the results demonstrate 3D printing molds as a viable fabrication method for creating CRM parts for building construction.

## Other Ways to Pay for the Public Life?

Brett Louis Snyder<sup>1</sup>, N. Claire Napawan<sup>1</sup>

<sup>1</sup>University of California at Davis, Davis, CA

**ABSTRACT:** Kresge College at the University of California Santa Cruz, originally designed in 1971 by Turnbull Associates and Charles W Moore Associates (MLTW), is well known both for its “stage set” like architecture as well as its use of environmental graphics. These graphics were designed to foster a sense of democracy and public participation. As part of a renovation and expansion led by Studio Gang Architects, we (the authors) contributed an updated wayfinding system that builds on the idea of participation while broadening it to include inhabitants’ relationship with the built and natural environment. While the original design centered on an inward facing street, the renewal connects outwards acting as a lens to the environment. The graphic strategy includes integrating graphics into materials (using bird-safe etched glass), highlighting the complex topography of the site (through large scale maps), and includes an augmented reality component allowing visitors added ways of connecting to the site (as well as the ability to see the current and original site overlaid). Augmented reality will allow users to access various social and ecological components of the College, from being able to see more about the multi-species that are native to this environment as well as to access historical information about the original MLTW buildings. By actively creating linkages between past and present, built and natural, this wayfinding system aims to highlight the way we actively participate in shaping our environment.

# Development of Window Apertures to Improve Natural Ventilation in Educational Buildings

Yun Kyu Yi<sup>1</sup>, Manal Anis<sup>1</sup>, Keunhyuk Jang<sup>1</sup>

<sup>1</sup>University of Illinois at Urbana Champaign, Champaign, IL

**ABSTRACT:** The recent global pandemic has left bare the flaws in our infrastructure as much as in buildings. With schools reopening, concerns for the safety and health of children have come to the forefront, as has the glaring inadequacies in air circulation in school buildings. Current practice of designing small openable window areas in educational buildings, allowing windows to open only 4-6 inches for children's safety, along with the use of old radiators and window-mounted air-conditioning units, have rendered classrooms devoid of adequate supply of fresh air. Absence of the ASHRAE recommended 6 air changes/per hour (ACH) in many poorly funded classrooms can potentially lead to serious consequence. The Epidemic Task Force for ASHRAE has proposed some guidelines for the reopening of schools, stressing adequate supply of outside fresh air according to ASHRAE Standard 62.1-2019. This research aims to investigate design strategies to improve air circulation through careful interventions in conventional apertures in classrooms. With clever design, airflow through existing window apertures can be augmented to maximize natural ventilation that can reduce risk of contamination by insufficient fresh air. The research aims to create a framework of design strategies that would enable an increased ventilation in a space under different wind conditions. The learning objectives of the study are to investigate the current aperture design, understand the different conditions impacting indoor air movement through apertures, propose alternative systems based on various wind conditions, and finally test the systems through CFD analysis to validate their robustness.

# Exploring Changes in Needs for Students Housing after the Pandemic

<sup>1</sup>Jinoh Park

<sup>1</sup>University of Tennessee, Knoxville, TN

**ABSTRACT:** This study explores the direction of new student housing design as student's lifestyle changes caused by COVID-19. This study confirmed the possibility of conducting research on a new student housing development direction by reviewing a set of literature: 1) industry trend on student housing, 2) evidence-based design to cope with the changing environment, and 3) Post-Occupancy Evaluation (POE) on the student housing. Based on the phenomenological perspective (Poulsen & Thøgersen, 2011) with the combination of lived experience (Ellis & Flaherty, 1992) and POE (Anderzhon, Fraley, & Green, 2007) methodologies, this research questions what changes in student's needs for housing change after the coronavirus outbreak. This study collected data by recording the life before and after the pandemic with multiple materials: sequence diagrams, texts, and photos, according to the POE format in which five study participants contributed their experiences. The collected data sets were presented by individual participants and analyzed by following discussion and semi-constructed interviews together. Through the analysis, this research identified changes in student's needs and issues compared with the student housing trend 2020 (Mueller & Havsby, 2020). As a result, this study illustrates a set of changes in needs for students housing during the COVID-19. According to the findings, research participants needs more 1) flexibility in layout, 2) private space and amenities, 3) solutions for noise issues, and 4) better delivery access. Even though it is difficult to generalize according to the limited number of study participants, the quality of this study was supplemented through multiple materials, peer reviewed analysis, and additional interviews and discussions. Consequently, this study can be referred to when universities develop new on-campus housing or when private developers plan off-campus housing. In addition, it is a reference material for student housing design projects in the architectural design studio, followed by pre-design research and evidence-based design.

# Public Policies for Sustainable Social Housing in Northwest Mexico

Dania Lizeth Castro Díaz<sup>1</sup>, José Manuel Ochoa De la Torre<sup>1</sup>

<sup>1</sup>Universidad de Sonora, Hermosillo, Sonora, MEXICO

**ABSTRACT:** In Mexico, sustainable housing policies are proposed as an alternative to improve the quality of life of the vulnerable population and at the same time, correct the housing deficit that exists in this country due, in part, to the lack of efficient regulations for the management of the growth of cities. It is expected that by 2030 Mexico will have approximately 50 million homes and to meet their needs, it will be necessary to build almost 11 million new homes between 2011 and 2030. However, the country's sustainable housing policies have not been a significant factor in the change towards sustainability. In contrast, they are closer to a rhetorical discourse, which remains in the passive design and use of certain technologies without considering the needs, aspirations, and conditions of accessibility for all economic strata. On the contrary, other authors point out that the programs have little time for implementation therefore, there are no precise evaluable results, making their analysis difficult when trying to determine the strengths and weaknesses. This research aims to compare sustainable housing programs such as Hipoteca Verde, Está es tu casa and Sisevive Ecocasa implemented in the city of Hermosillo, Sonora, in order to identify the quantifiable and non quantifiable benefits to users. In addition to analyzing the tools and parameters that make them up. During the analysis of the programs, we found that Sisevive Ecocasa is based on the programs Hipoteca Verde and Está es tu casa. However, unlike these, Sisevive Ecocasa addresses the construction's energy efficiency based on the house's global performance, setting standards for the total energy demand, according to the prototype and the bioclimatic zone. This approach implements monitoring, reporting, and verification system for each house.

# Performative Nomadicism and the No-Place

Jessica Hanzelkova<sup>1</sup>

<sup>1</sup>University of Waterloo, Waterloo, CANADA

**ABSTRACT:** This poster, in addition to conducting literary research is to be accompanied by performance art. A series of images taken to explore transience and anonymity in a pre-pandemic urban landscape will accompany the poster as a form of visual dialogue. The performance art captured in these images enacts a performance of nomadicism in covering the face using artifacts/masks designed by the author, photographed in public spaces (ie. sidewalks, courtyards, intersections). By having the images side-by-side with the text, the author's assertion of the no-place, as an embodied nomadicism, is explored through multiple timelines (pre- and during pandemic) and through two mediums (literary research + critique and image-based art) to produce a paper that visually provokes multiple understandings of the material.



# Site Net Zero Contemporegional Architecture – The Barn Haus in Utah

Jörg Rügemeier<sup>1</sup>

<sup>1</sup>University of Utah, Salt Lake City, UT

**ABSTRACT:** The Barn Haus project was initiated in 2017 when clients approached the faculty author to design a 3,800 SF, research-driven high-performance home for a location specific climate. The project outcome shows that resilient, sustainable custom-designed buildings can be developed at high quality within market-rate budgets, therefore considerably raising the bar for residential buildings in the region. The goal was reached through application of a holistic, integrated process that explored means of passive-to-active house strategies, architectural minimalism, focusing decisively on the genius loci in combination with a custom-tailored program and high building performance goals. The project was also taken into the author's classrooms in form of lectures and frequent site visits during the AYs 2018 to 2020. Nestled into a south-facing slope at the bottom of the Rocky Mountains, the Barn Haus offers magnificent views coupled with a perfect winter solar exposure. The location on a former horse pasture allowed for an abstract formal and spatial interpretation of traditional barn outbuildings, thus creating a new contemporegional architectural style that reflects a strong sense of place. Architectural aesthetics then carefully blend with a contemporary architecture approach and high-performance. Focusing on formal clarity and reduction in shape and materiality, the solution recalls the straightforward functionality of agricultural buildings, yet clearly establishes the expression of a residence. The Barn Haus' integration into its genius loci became a key driver for the design process, including all characteristics of orientation, existing topography, landscape and views. Daylight conditions, with the potential of passive solar winter heat gain, were another key driver for careful building orientation and the vigilant placement of openings in the building's envelope. Aspects such as minimized cut & fill, working with site constraints, building access, and all aspects of a passive to active high performance building further defined the framework in which the Barn Haus was developed. As the most important strategy towards building resilience, the Barn Haus utilizes non-combustible, highly durable exterior materials exclusively. This constitutes a paramount design decision due to prolonged droughts and extreme temperatures that lead to increased forest fires in the region. In tandem with a 50-foot perimeter fire zone, the project will withstand fires hazards better than standard residential buildings, adding peace of mind to a structure that already offers resilient shelter on the energy, performance and disaster-survivability side. Furthermore, materials have been carefully selected for minimized environmental impact, to ensure highest indoor environmental quality. A whole-house Energy Recovery System with MERV 14 filters provides continuous, pre-conditioned clean air to the house.

## Assessment Of Housing and Urban Context From An Aging In Place Framework And Its Impact In The Quality Of Life Of Older Adults

Margarita Ibarra Platt<sup>1</sup>, Maria Guadalupe Alpuche Cruz<sup>1</sup>

<sup>1</sup>Universidad de Sonora, Hermosillo, Sonora, MEXICO

**ABSTRACT:** Demographic aging is a phenomenon more present every day in cities around the world. In the case of Mexico and most Latin American countries, this is happening at such a fast rate that it will demand action in many scenarios, like urban planning and residential offer. With a growing population of older adults, the need to have age friendly environments (homes, neighborhoods and cities) becomes more relevant each day. This population has special needs in matters of accessibility, safety, health and mobility, which is why the place they call home needs to be an ally and support healthy aging and not become an obstacle. In this context, this work aims to study how adequate the urban and housing context is for aging-in-place according to the perception of older adults. By a method of observing the urban context of selected zones with a higher percentage of older adults, it is expected to determine its age-friendliness, and compare this information with the results of a survey applied to older adults living in these areas. Some of the first findings are that more than 20% of all older adults in Hermosillo, live in a specific area of the city, showing age grouping patterns and therefore making it more important that these zones are age friendly. Knowing what older adults consider important in their living spaces can help prioritize actions to improve future planning of cities, housing and public space design and also to improve conditions for present day older adults aging in place.

# The Sound Pavilion

Rachel Dickey<sup>1</sup>

<sup>1</sup>University of North Carolina at Charlotte, Charlotte, NC

**ABSTRACT:** The Sound Pavilion is a prototype developed to demonstrate how sound performance can drive the conceptual agenda for a project by articulating the conditions of spatial experience through the design of architectural surface. The pavilion demonstrates the capacity of typical architectural materials to preserve and direct elements of sound from the speakers through reflection, while also reducing exterior noise through diffusion. These components provide a design opportunity to articulate space through change in sound volume and quality. The two acoustical tools that manipulate the conditions of spatial audio in the pavilion design include surface diffusion and form based reflection. In order to accommodate a spectrum of sound wavelengths, the surface design includes a range of scale in surface texture, depths, and angles to provide a range of diffusive qualities. Variation of these characteristics is optimal for diffusing a range of frequencies. Ray tracing simulations aid in the design process and provide a way to examine the reflection patterns from a variety of different surface conditions with a comparison of the behavior of rays that reflect secularly and diffusely. The second acoustical component for the pavilion involves preservation and intensification of sound through form based reflection. Specifically the project uses concave surfaces to focus sound energy from the speakers, while the convex sides of the panels with the surface texture diffuse sound from outside sources. The concave reflective surfaces create heightened auditory spaces with concentrated sound. In order to demonstrate the architectural expression of acoustics with the pavilion, the design team collaborated with a musician to compose various corresponding tracks played from different channeled speakers embedded in key geometrically altering sound panels. This collaboration activates the pavilion as an architectural instrument, which generates a unique auditory experience based on the guests' proximity in and around it.

# Energy Performance Evaluation in the Design Process of Façade-Integrated Green Living Walls Using Digital Simulation

Tazrin Islam<sup>1</sup>, Ute Poerschke<sup>1</sup>, Yasmine Abbas<sup>1</sup>

<sup>1</sup>Pennsylvania State University, State College, PA

**ABSTRACT:** The study proposes a digital simulation-based workflow for assessing the energy performance of façade-integrated green walls to support the current practice of empirical knowledge-based intuitive design. The study focuses on "living walls," which are a specific type of green walls where the plant, substrate and structural support are directly integrated with the building wall. The thermal potential of vegetation-integrated walls varies with climate type and context requiring case-by-case assessment for informed decision making. Due to the complex biological properties of vegetation, building information modeling (BIM) or building energy performance simulation (BEPS) programs do not yet include specific assessment tools for green walls limiting the scope of the performance-based evaluation. Most studies on thermal benefits are experimental or mathematical model-based which are not suitable for architects and designers. Few studies used building simulation programs where various modeling techniques are self-developed by researchers due to the lack of dedicated simulation tools. These studies are rarely combined with digital design platforms such as BIM or 3D modeling. In this regard, within the limitations of the current simulation tools, this study adopts the 'Green-roof' module of the widely used simulation engine Energy-Plus based on previous studies as this plug-in includes plant properties. Then the impact of variable changes in a living wall such as plant leaf area index, substrates, moisture and façade design aspects such as ratio, placement, and orientation of the living wall in a design case. The aim is to incorporate scientific research findings with a digital design platform using BIM and BEPS programs together.

# Pilot Test of an Instrument for Vulnerability Assessment in Mexican Regulation, Case Study: Pharmaceutical Cleanroom

Fernando Arvayo-Ballesteros<sup>1</sup>, Oscar Armando Preciado-Perez<sup>1</sup>

<sup>1</sup>Universidad de Sonora, Hermosillo, Sonora, MEXICO

**ABSTRACT:** Uncertainties arise when a norm or standard is ambiguous, unrigorous, or unwieldy. This must be resolved immediately to avoid failures in the decision-making process. This investigation is aimed to quantify in a qualitative way, the extent of vulnerability in the standard for Pharmaceutical cleanrooms in the Mexican Regulation. To achieve this, the development of an instrument to facilitate comparison between standards was proposed. Therefore, the theoretical framework provided by risk theory and the concept of vulnerability is a good point of departure, as well as a multidisciplinary approach. According to several authors, risk can be estimated by combining three variables: exposure, hazard, and vulnerability. At this point, vulnerability is resumed as an independent variable to evaluate, by modelling an instrument, the endogenous and exogenous stressors that a norm or standard imposes on a physical system, in this case, the pharmaceutical cleanroom. Implementing the basic content analysis method, literature review led to building a verification instrument comprising more than 500 indicators. Following a detailed analysis, the list was shortened into 32 items for a feasible and yet confident instrument. The indicators proposed were well validated by experts. Subsequent to the application of the test-standard reliability method, the indicator for the extent of enforceability achieved a Krippendorff's alpha of 0.76, and a GwetAC2 of 0.98. Additionally, proposed indices and indicators, as well as frequencies, are analysed, providing a mapping of the potential sources of regulatory vulnerability that can affect a pharmaceutical cleanroom. The instrument reveals a variety of interdisciplinary interpretations with a focus on normative vulnerability associated with a highly technological architectural space such as the one considered in this research.

## Methodology For the Valuation of Sustainability in Real Estate

Sandra Guerrero<sup>1</sup>, (N) Irene Marincic<sup>1</sup>

<sup>1</sup>Universidad de Sonora, Hermosillo, Sonora, MEXICO

**ABSTRACT:** The implementation of new technologies and systems applied in real estate to improve people's living conditions also represent benefits on various aspects that have a positive impact on the reduction of energy consumption, savings on consumption expenditure and the impact on quality and improvement of the environment. The issue of sustainability and the application of the rules of the new urban agenda on real estate, makes it necessary to include in the methodologies established for the valuation of real estate these indicators that represent an added value on the property, for this reason a proposal is presented for establish sustainability indicators that can be incorporated into the methodologies used and, in turn, present us with parameters that benefit both the user of the real estate and the environment in general. The objective of this topic is to present a proposal for the real estate valuation methodology, which considers the sustainable aspects of the asset to be valued, and includes the following environmental variables in this analysis: energy efficiency; use efficiency of water and arborization, these variables are analyzed and the following data is proposed as expected results: Cost - benefit of the investment; reduction of CO2 emissions; reduction of heat gain in spaces and finally applied as a sustainability factor that affects the final value of the real estate, obtained by traditional methods.

## Spatial Improvisation Exercises for Architects

Gray Read<sup>1</sup>

<sup>1</sup>Florida International University, Miami, FL

**ABSTRACT:** Part of the preparation for dramatic acting is a series of improvisation exercises that help actors hone their skills. Might architects engage in parallel exercises that explore the performative potential of built elements? In classes at Florida International University School of Architecture I developed a series of exercises that invite young architects to consider built spaces as what Bruno Latour calls “non-human” actors: In large classes, student teams do a short exercise, analyzing our school of architecture building to find places of dramatic potential, which they interpret in 10-second scenes and draw in storyboard, plan and section. In design studio students in pairs constructed a third actor to participate with them in a performance that addressed one of architecture’s fundamental social qualities. In a weeklong workshop in Genoa, Italy students made short videos that combined scenes with drawings to explore the inherent drama of fundamental elements of architecture – door, wall, steps. All of these exercises investigate interactions between built spaces and people, who, in their movements, interpret these spaces for their own purposes in the course of daily life.

## Informal Health Access in Liminal Space

Ulysses Vance<sup>1</sup>

<sup>1</sup>Temple University, Philadelphia, PA

**ABSTRACT:** According to the COVID-19 Hospitalization Tracking, provided in the Analysis of HHS data by the University of Minnesota Hospitalization Tracking Project, the most extreme urban and rural hospitals reported overcrowded ICU beds upwards of 75% capacity in 2020. With the continued surge in medical care and, in particular, the long-term intubation of patients, space for procedures comes at a premium. Concurrently, per the American Hospital Association, the expense per capita in the hospital is approximately \$4500 per patient, and considering that in these conditions, patients are primarily confined to a bed in a shared environment, the cost for recovery in these spaces is over-extended past the cost typically associated with particular types of care. The investigation into utilizing liminal spaces in Medical Facilities to support care involves determining whether ambulatory care support in corridor space can relieve the strain of overcrowding inpatient areas. By definition, liminal space is inactive or underutilized space. However, in hospitals and medical facilities, they incorporate everything from support spaces to patient wards. In determining the feasibility of transitioning support for ambulatory patient care from egress paths to into temporary patient service zones, the work of this research interrogates lighting techniques, screening techniques, and material identification to subtly inform persons in these conditions as to places in use and bring attention to changing needs for maintaining safe distances from others. The resolute inquiries consider the behavioral, biological, and bodily requirements for patient recovery guided by intentionally maintaining medical integrity’s physical closeness.

# Human-Robot Interactive Synergy (HRIS)

Mona Hashemi<sup>1</sup>, Ebrahim Poustinchi<sup>1</sup>

<sup>1</sup>Kent State University, Kent, OH

**ABSTRACT:** Using industrial robots in projects other than fabrication and mass production has attracted wide range of attention among architects and designers. These machines have become a means for creative study in design and architecture, and there has been a lot of research in this field in academia and practice. Although the researchers have tried to propose nonconventional use of robots in design disciplines, these developments are still in their initial steps and need more exploration in different design related categories. HRIS is project based research that aims at taking a deeper look into the robotics opportunities in creative design through a drawing experiment. It enables real time interaction with the robot arm through human inputs and a custom made end effector. In this project, the human robot collaboration interface is designed based on a hand drawn input by the human user. The image recognition process through the implemented camera, the data processing in the computer, and the robot feedback are the processes through which this real time interaction becomes possible. The Scorpion plugin in Grasshopper provides the necessary tools for controlling the Universal robot and acts as the bridge between the computer and the physical robot. Understanding how the raw data can be transmitted to the computer through vision and sensor feedback how it can be processed and finally sent back to the robot are the critical parts of this experiment. This research demonstrates how the robot can actively respond to human movement in real time and how this feedback can be systemized and programmed in a third machine. This platform exemplifies a hybrid collaboration in which the communication between human and robot enhances the robotic capabilities and the computational control of the process. HRIS provides the opportunity for users to participate in a collaborative drawing workflow without having expertise or background in robot related software.

# Classification of Natural Plant Physiology, Behavior and Morphology to Inform an Adaptive Architecture

Anahita Modrek<sup>1</sup>, Kirk Dimond<sup>1</sup>, Susannah Dickinson<sup>1</sup>, Aletheia Ida<sup>1</sup>

<sup>1</sup>University of Arizona, Tucson, AZ

**ABSTRACT:** Early research in this work focuses on developing a classification of the meanings of responsiveness, as a mode of adaptation, at different scales. There is a growing cultural fascination with new knowledge of nature's science and of natural forms, both living and non-living. Design based on the integration of nature's science and architecture seems a practical and environmentally friendly strategy for designers in this era. As architecture allows us to create environments in which we can flourish, there is no better place than the natural world for inspiration. Therefore, different plant systems are investigated through a comparative and woven framework of intersecting regional challenges. The materials and the natural systems of adaptation that emerge through identification of prevalent regional opportunities impacting multiple aspects of a society could provide implications for local design and construction methods. The adaptation system of these plants is established through three main characteristics: physiological, behavioral, and morphological. Each of these characteristics are a function of dynamic systems as expressed by visible and non-visible change. In this research different features of pine conifer, wheat, and ice plants that can fold and unfold are studied and classified in behavioral groups based on changes in their physical characteristics at different scales in response to humidity. Other examples include mangrove plants that physiologically filter water-borne pollutants, and desert cacti that develop specific morphologies (such as ridges, bristles, and spines) and shallow root systems to adapt to harsh climate conditions. The evaluation of these natural systems for commonalities and differences through methodical and rigorous comparison of their flows and compositions reveals that adaptive systems have a strong relationship with context. Similar systems in varying contexts have different performance characteristics and different ways of responding because of the complex set of parameters within the context of evolutionary design. These adaptive systems in nature respond to a complex challenge, showing inherent traits that allow for adaptation to climate change, indicating that both material selection and design strategies need to be based on the specific ecological realities of a given context.

# Building a Morphology in the Data of Urban Things

Brian T. Rex<sup>1</sup>, Mahmoud Sadek<sup>1</sup>, Autumn Schlomer<sup>1</sup>

<sup>1</sup>South Dakota State University, Brookings, SD

**ABSTRACT:** We are an urban design team studying a place that sat for 100 years as empty space on the Public Land Survey System (PLSS); a place whose geometry is locked into a mature PLSS. We utilize graphical projection systems in our practices. We began naively trying to integrate ARCH GIS into our workflow few years ago. As with any new technology, we aimed to create a direct connection between the data in GIS and the geometries of the places we were generating in our design practices. What we found is that GIS in urban design presents an interesting dilemma. GIS is alluringly graphical. Yet its graphical engine is not essentially geometric. It is geographic. Location in GIS is defined by coordinate. Information is then attached to that cartesian coordinate. GIS boundaries are derivative in their definition. The graphical shapes and surfaces are parsed presence-lines of inflection between types, values, chronologies, or qualities of data. They are not the concrete bounds between things ripe with geometry that we use to make place. The locations of data in geographic coordinate systems and those in geometric gridded systems bridge the divide between systems when the city form is a grid rooted in the metric of the PLSS. The Jeffersonian grid is both geography and geometry. Through this bridge we produced translations and practices of GIS graphics to gridded urban design geometries. We aggregated varied datasets and built a practice translating the graphical representations of GIS into the geometries in which we build. This practice of connecting datasets to delineated graphical traces creates a morphological yet phenomenal narrative of urban things. It presents space in the city as both formal and motive. It juxtaposes and conventional · new combinatory shapes of time, value, and volume by exploiting the overlap condition of geometric and geographic definition on the PLSS.

# Phoenix Performs!

Elena Rocchi<sup>1</sup>

<sup>1</sup>Arizona State University, Tempe, AZ

**ABSTRACT:** The increased reliance on cars' transportation turns the city's form invisible, therefore, receptive to any change of meaning. While driving, its built space collapses in the car's framed existential space with a field of view and becomes an espace propre as the effect of what it is imagined. The research presented is about a study conducted teaching a graduate architecture studio course using a methodological approach to in-depth explorations of a city's perceptions using films documenting site as data collection. The observation subject is the image of Phoenix and its urban sprawl's nature — absence. Building upon the analogous relationship between cinematic processes and built form, the study explored the development of an architectural concept from the domain film. Tested during 2017, the studio exploited cinematic representations of the built environment to collapse virtual spatial experiences. The research's purposes were to construct a space's narrative, establish a connection between perception and architecture, and recognize that the use of trans-mediation is a convergent tool in architecture's theory and practice. The procedure of two instrumental phases was sequential: the outcome of looking at Hitchcock's Psycho's initial movie's sequence informed students' films' scripts. The instructor offered tutorials of iMovie. What was tested was the ability to collapse time and space and compose visual narratives frame-by-frame and the learning device (cinema) following a central research question: How can film be used to frame theoretical making/teaching pedagogies in architecture? The achieved outcome was an understanding of how film filters perception of the presence of the built environment. Film discourses can actively shape architecture as, in both practices, time is translated into movement and space measurements. Film is a dynamic representational medium offering the ability to render existential space in a frame and, as architecture, to reconsider it within the view frame.



# Cities or Urbanization? Urbanism as Object | City as Process: Pedagogical Permutations + Provocations of the In-Between

Brian R. Sinclair<sup>1</sup>, Alberto de Salvatierra<sup>1</sup>

<sup>1</sup>University of Calgary, Calgary, CANADA

**ABSTRACT:** The “city”—as a construct—has loomed large in our lexicon, both within environmental design fields and in the broader public discourse. Urbanization, as a phenomenon intensified over recent centuries, has seen cities amplify and the hinterland shrink. Consequently, common understandings and characterizations of the city have, in recent decades, come under increased scrutiny and skepticism with many in academia and practice questioning the validity of the concept. The present research, pedagogical in focus, is situated at the nexus of the debate: Is the city a discrete object or has its boundaries been eroded by far reaching and broad scale urbanization? A senior graduate level required course, situated in an accredited Master of Architecture program, ARCH 675: Urban Systems focused on the contemporary city with an eye to fostering discourse and debate on the legitimacy of the circumscribed city in a traditional sense and the possibilities of unbounded urbanization as an emergent phenomenon. Co-taught by the authors, Urban Systems aggressively recasts questions of the city in light of shifting landscapes and dramatic forces: on one hand long-standing developments such as global migration and the movement of capital, while on the other more recent emergencies including climate change, economic downturns and health crises. Overarching explorations of the city and urbanization was an acceptance of complexity and an aspiration to develop in students both world and self views. Course textbooks, *The City Reader* (Ed: LeGates and Stout, 2020) and *Implosion/Explosion: Towards a Study of Planetary Urbanization* (Ed: Brenner, 2014), together illuminate a strategy by the present researchers to have students critically travel to some theoretical edges in an effort to better grasp the in-between. Lectures on foundational topics were delivered—augmented by panels of guests, drawn from across the globe, addressing geographic zones like Europe, Africa, Asia and the Americas. A key learning goal was to expose students to an impressive spectrum of viewpoints, strategies, conditions and outcomes in an attempt to develop critical thinking and open minds. The semester-long course, with enrolment of approximately 70 students, required three assignments: a weekly journal, an individual urban manifesto, and a group-based videographic essay. These three tasks, in a complementary manner, compelled students to critically reflect on course content and to assume positions on architecture, the city, urbanization and the trajectories of civilization. The manifesto aimed at sharpening individual views—explained ways of thinking that students deemed potent and appropriate given the daunting challenges of city building in dynamic and often chaotic times. In a complementary sense, the videographic essay shaped a collective stance—considering material flows as paramount to the reinterpreting, rescaling and redesigning of urban patterns. The research concludes with critical observations on the delineated learning model and suggestions for addressing urbanism in the curriculum. Students in schools of architecture across the planet are now immersed in a milieu of upheaval and uncertainty, compelled to rethink their world in light of a deadly pandemic, social unrest, climate change, propaganda wars and widespread turbulence. ARCH 675: Urban Systems, in response, challenged students to better understand such daunting complexity, to begin to critically question conventional posturing around the construct of the city, and to imaginatively design and develop world and self views that resonate with the realities of our indeterminate and perplexing times.

## Development and Construction of the Field of Dreams Ecocommunity

Jörg Rügemer<sup>1</sup>

<sup>1</sup>University of Utah, Salt Lake City, UT

**ABSTRACT:** The Field of Dreams EcoCommunity (FOD) was developed as a collaborative effort between the author as researcher and architect and the client, a non-profit organization offering services related to affordable housing and inexpensive building materials. In this function as a homebuilder, the client also acts as its own general contractor, which set the stage for the development of FOD. The project is the re-imagining of the affordable housing typology in the Southwestern States of the United States and consists of twenty, 1,500 square foot units in ten twin-home buildings, newly constructed on an abandoned baseball field in close proximity to Salt Lake City, Utah. As one of the development guidelines, underlying principles of how we live and the types of spaces we need to accommodate these desires were re-examined, challenging the contemporary notion that quantity of space supersedes quality of space and design clarity, with the goal to provide high quality of living within an optimized, moderate footprint that is sensitive to both its inhabitants and the local environment. To achieve these goals, FOD is the synthesis of both modern technology and vernacular principles – unlike traditional modern buildings in the US, FOD utilizes what is immediately available onsite as its primary energy source in form of passive winter solar heat gain; it supplements only what cannot be generated onsite to meet modern standards of comfort through technological means. Traditional ideas of orientation, passive energy design, thermal massing and aspects of daylighting are key elements in the outward expression of the building's massing. This strategy creates an energy-efficient building with a high resilience factor, thus making the survival in extreme climate conditions possible without external energy sources – all without increased capital investment.

## Designing Roofs to Support Native Plants in the Great Lakes Region

Meghan Blackson<sup>1</sup>, Reid Coffman<sup>1</sup>, Nick Safley<sup>1</sup>, Christopher Blackwood<sup>1</sup>

<sup>1</sup>Kent State University, Kent, OH

**ABSTRACT:** Roofs are being designed with native plants to make cities more ecologically productive and biologically diverse. Most architects know little about native planted roofs, particularly how roofs can be designed to support local biodiversity. From selecting plant species, to substrate composition, to navigating the construction process, designers are often left without clear guidelines. Without this information, the resulting green roofs are often lacking in biodiversity, as well as ecosystem health. To solve these problems, the study first compiled regional published species into a sortable database of green roof plants. This database enables sorting and selection of a variety of specific design attributes for professional and research use. Secondly, a multifactorial field trial comparison using thirty-six 1m<sup>2</sup> green roof plots showed that the type of growing substrate, rather than native species, may have most influence effecting yearly weed maintenance and ecosystem health. Thirdly, the study provides a case study on a green roof installation on the Cleveland lakefront incorporating native plants and soils for biodiversity. Offered here are lessons learned for the design and construction fields. The results of this study lead to better understanding of how to design for greater ecological productivity, native plants, and biodiversity in roof systems.

# Post-Revolutionary Discourse Reflected Through Architecture in Hermosillo, Sonora (1920-1950)

Anabel Leyva Hernandez<sup>1</sup>, Juan Luis Loredo Lopez<sup>1</sup>

<sup>1</sup>Universidad de Sonora, Hermosillo, Sonora, MEXICO

**ABSTRACT:** The governments emanating from the Mexican Revolution sought to represent the social ideals and achievements obtained through this conflict via their architectural and aesthetic speech developed in the decades after the end of this armed struggle in the city of Hermosillo, Sonora. The hypothesis mentioned above is the starting point of this research. To validate this conjecture, the following objectives were established: to know the way in which revolutionary ideas were represented in the institutional architecture in Mexico; understand how the ideals of the Mexican Revolution influenced the architectural development of the government in the decades after the struggle in Hermosillo, Sonora; explore which were the main architectural representations made by the state administrations of that time in the state capital. The methodology used is qualitative, inductive and with a narrative design supported by official documents, catalog, photograph, field research and interviews with experts on historical, social and architectural affairs of the city at that time. Currently this research is in the process of development, however, it is possible to identify some partial but inconclusive results. What we can anticipate is that in the city of Hermosillo, the examples of institutional architecture of the post-revolutionary period had a late manifestation. A possibility to support this claim revolves around the attempts to imitate the architectural trends used in Mexico City and its surrounding area. Therefore, examples of institutional buildings can be found, in Hermosillo, of great similarity to representative buildings of the aesthetic speech manifested by the post-revolutionary governments. As an example, we can mention the Main building of the University of Sonora, built in the 1940s. This construction shares architectural characteristics typical of the neocolonial style used in the main educational complexes of Mexico City that were built in the 1920s.

# Traditional Ecological Knowledge (TEK) as Performative Environments + Ecologies-Integrated Land-Based Learning into the Architectural Curriculum and Design Research

Shannon Bassett<sup>1</sup>

<sup>1</sup>Laurentian University, Ontario, Canada

**ABSTRACT:** This poster paper investigates the transformative potentials and paradigmatic shift inherent within the integration of land-based learning and traditional indigenous knowledge into the Architectural curriculum and design research. It uses the architectural design studio led at the -as a vehicle for design research and pedagogy. Students engaged in the cladding of a wigwam, as part of a design-build project, a bent-wood structure built by the previous year's cohort, located on the University campus and used as a community space and teaching lodge. An Indigenous Elder and Knowledge Carrier from the - Indigenous community are School staff. Birch bark was harvested for shingles, spruce gum was also harvested. Students then clad the wigwam as part of a design build, translating oral knowledge from our Indigenous Elder, imbued with understandings of intrinsic relations to sacred landscapes and ecology into the architectural project. Explorative drawings were created of the structure. Harvesting from the land teaches students about the inherent properties and latent potentials of the landscape materials as performative ecological technologies as alternatives to modern industrialized technologies. Collaboration and community-engagement with Indigenous communities continued with online modalities. Choreographed architectural "transverses" are curated through the landscape, documenting and grounding students on a remote site. Video from the previous year's studio for a knowledge dissemination grant is re-tooled to serve as instructional video for students. Studio kits of natural materials were sent to students. How do these frameworks inform and transform our design research?



# PERFORMATIVE ENVIRONMENTS

## **Best Research Paper Award**

**Investigating Scales Of Performance:**

**Mycelium Ecomanufacturing In Dhaka's Urban Settlements**

Iffat Ridwana, University of Cincinnati and

Mae-ling Lokko, Rensselaer Polytechnic Institute

## **Best Research Poster Award**

**Assessment of Housing and Urban Context from an Aging-In-Place  
Framework and its Impact in the Quality of Life of Older Adults**

Margarita Ibarra Platt, Universidad de Sonora, Mexico

Maria Guadalupe Alpuche Cruz, Universidad de Sonora, Mexico

PERFORMATIVE

ENVIRONMENTS

**ARCC**  
**2021**

